



HF/50 MHz TRANSCEIVER

FT-2000

Technical Supplement

©2006 VERTEX STANDARD CO., LTD.

EH025H90A

VERTEX STANDARD CO., LTD.

4-8-8 Nakameguro, Meguro-Ku, Tokyo 153-8644, Japan

VERTEX STANDARD

US Headquarters

10900 Walker Street, Cypress, CA 90630, U.S.A.

YAESU EUROPE B.V.

P.O. Box 75525, 1118 ZN Schiphol, The Netherlands

YAESU UK LTD.

Unit 12, Sun Valley Business Park, Winnall Close
Winchester, Hampshire, SO23 0LB, U.K.

VERTEX STANDARD HK LTD.

Unit 5, 20/F., Seaview Centre, 139-141 Hoi Bun Road,
Kwun Tong, Kowloon, Hong Kong

VERTEX STANDARD (AUSTRALIA) PTY., LTD.

Normanby Business Park, Unit 14/45 Normanby Road
Notting Hill 3168, Victoria, Australia

Introduction

This manual provides technical information necessary for servicing the FT-2000 HF/50 MHz Transceiver.

Servicing this equipment requires expertise in handling surface-mount chip components. Attempts by non-qualified persons to service this equipment may result in permanent damage not covered by the warranty, and may be illegal in some countries.

Two PCB layout diagrams are provided for each double-sided circuit board in the Transceiver. Each side of is referred to by the type of the majority of components installed on that side ("leaded" or "chip-only"). In most cases one side has only chip components, and the other has either a mixture of both chip and leaded components (trimmers, coils, electrolytic capacitors, ICs, etc.), or leaded components only.

While we believe the technical information in this manual to be correct, VERTEX STANDARD assumes no liability for damage that may occur as a result of typographical or other errors that may be present. Your cooperation in pointing out any inconsistencies in the technical information would be appreciated.

Contents

Specifications

Exploded View & Miscellaneous Parts

Block Diagram

Connection Diagram

Alignment

Board Unit (Schematics, Layouts & Parts)

MAIN Unit

VRF Unit

BPF Unit

ANT Unit

DVS Unit

CNTL Unit

LOCAL Unit

RX-2 Unit

PA-A Unit

TUNER-MAIN Unit

TUNER-CNTL Unit

DSP Unit

VR-A Unit

VR-B Unit

SW-A Unit

MIC Unit

JACK Unit

KEY Unit

BACK-LIGHT Unit

F-CONNECT Unit

Provided by
YAESU museum

Downloaded by
RadioAmateur.EU

Specifications

General

Rx Frequency Range:	30 kHz - 60 MHz (operating) 160 - 6 m (specified performance, Amateur bands only)
Tx Frequency Ranges:	160 - 6 m (Amateur bands only)
Frequency Stability:	±0.5 ppm (after 1 minute @+77 °F [+25 °C]) ±1.0 ppm (after 1 minute @+14 °F ~ +122 °F [-10 °C ~ +50 °C])
Operating Temperature Range:	14 °F ~ +122 °F (-10 °C ~ +50 °C)
Emission Modes:	A1A (CW), A3E (AM), J3E (LSB, USB), F3E (FM), F1B (RTTY), F1D (PACKET), F2D (PACKET)
Frequency Steps:	1/10 Hz (SSB,CW, & AM), 100 Hz (FM)
Antenna Impedance:	50 Ohms, unbalanced 16.7 - 150 Ohms, unbalanced (Tuner ON, 160 - 10 m Amateur bands) 25 - 100 Ohms, unbalanced (Tuner ON, 6 m Amateur band)
Power Consumption: (@117 VAC)	Rx (no signal) 70 VA Rx (signal present) 80 VA Tx (100 W) 450 VA
Supply Voltage:	AC: 90 VAC - 132 VAC or 180 VAC- 264 VAC DC: DC 13.8 V ± 10%
Dimensions (WxHxD):	16.1" x 5.3" x 13.8" (410 x 135 x 350 mm)
Weight (approx.):	32 lbs (14.5 kg)

Transmitter

Power Output:	5 - 100 watts (2 - 25 watts AM carrier)
Modulation Types:	J3E (SSB): Balanced, A3E (AM): Low-Level (Early Stage), F3E (FM): Variable Reactance
Maximum FM Deviation:	±5.0 kHz/±2.5 kHz
Harmonic Radiation:	Better than -60 dB (160 - 10m Amateur bands) Better than -70 dB (6m Amateur band)
SSB Carrier Suppression:	At least 60 dB below peak output
Undesired Sideband Suppression:	At least 60 dB below peak output
Audio Response (SSB):	Not more than -6 dB from 300 to 2700 Hz
3rd-order IMD:	-31 dB @14 MHz 100 watts PEP
Microphone Impedance:	600 Ohms (200 to 10 kOhms)

Provided by
YAESU museum

Downloaded by
RadioAmateur.EU

Specifications

Receiver

Circuit Type:	Main (VFO-A); Triple-conversion superheterodyne Sub (VFO-B); Double-conversion superheterodyne																														
Intermediate Frequencies:	Main (VFO-A); 69.450 MHz/450 kHz/30 kHz (24 kHz for AM/FM), Sub (VFO-B); 40.455 MHz/455 kHz																														
Sensitivity (RF AMP 2 "ON"):	SSB (2.4 kHz, 10 dB S+N/N) 6 μ V (0.1 - 1.8 MHz) 0.2 μ V (1.8 - 30 MHz) 0.125 μ V (50 - 54 MHz) AM (6 kHz, 10 dB S+N/N, 30 % modulation @400 Hz) 3.2 μ V (0.1 - 1.8 MHz) 2 μ V (1.8 - 30 MHz) 1 μ V (50 - 54 MHz) FM (BW: 15 kHz, 12 dB SINAD) 0.5 μ V (28 - 30 MHz) 0.35 μ V (50 - 54 MHz) There is no specification in frequency ranges not listed.																														
Squelch Sensitivity: (RF AMP 2 "ON")	SSB/CW/AM 2 μ V (0.1 - 30 MHz) 2 μ V (50 - 54 MHz) FM 1 μ V (28 - 30 MHz) 1 μ V (50 - 54 MHz) There is no specification in frequency ranges not listed.																														
Selectivity (-6/-60 dB):	Main (VFO-A) <table><tr><td>Mode</td><td>-6 dB</td><td>-60 dB</td></tr><tr><td>CW/RTTY/PKT</td><td>0.5 kHz or better</td><td>750 Hz or less</td></tr><tr><td>SSB</td><td>2.4 kHz or better</td><td>3.6 kHz or less</td></tr><tr><td>AM</td><td>6 kHz or better</td><td>15 kHz or less</td></tr><tr><td>FM</td><td>15 kHz or better</td><td>25 kHz or less</td></tr></table> (WIDTH: Center, VRF: OFF) Sub (VFO-B) <table><tr><td>Mode</td><td>-6 dB</td><td>-60 dB</td></tr><tr><td>CW/RTTY/PKT</td><td>1.1 kHz or better</td><td>3.0 kHz or less</td></tr><tr><td>SSB</td><td>2.2 kHz or better</td><td>4.5 kHz or less</td></tr><tr><td>AM</td><td>6 kHz or better</td><td>25 kHz or less</td></tr><tr><td>FM</td><td>12 kHz or better</td><td>30 kHz or less</td></tr></table>	Mode	-6 dB	-60 dB	CW/RTTY/PKT	0.5 kHz or better	750 Hz or less	SSB	2.4 kHz or better	3.6 kHz or less	AM	6 kHz or better	15 kHz or less	FM	15 kHz or better	25 kHz or less	Mode	-6 dB	-60 dB	CW/RTTY/PKT	1.1 kHz or better	3.0 kHz or less	SSB	2.2 kHz or better	4.5 kHz or less	AM	6 kHz or better	25 kHz or less	FM	12 kHz or better	30 kHz or less
Mode	-6 dB	-60 dB																													
CW/RTTY/PKT	0.5 kHz or better	750 Hz or less																													
SSB	2.4 kHz or better	3.6 kHz or less																													
AM	6 kHz or better	15 kHz or less																													
FM	15 kHz or better	25 kHz or less																													
Mode	-6 dB	-60 dB																													
CW/RTTY/PKT	1.1 kHz or better	3.0 kHz or less																													
SSB	2.2 kHz or better	4.5 kHz or less																													
AM	6 kHz or better	25 kHz or less																													
FM	12 kHz or better	30 kHz or less																													
Image Rejection:	70 dB or better (160 - 10m Amateur bands) 60 dB or better (6m Amateur band)																														
Maximum Audio Output:	2.5 W into 4 Ohms with 10% THD																														
Audio Output Impedance:	4 to 8 Ohms (4 Ohms: nominal)																														
Conducted Radiation:	Less than 4000 μ W																														

Specifications are subject to change, in the interest of technical improvement, without notice or obligation, and are guaranteed only within the amateur bands.

Provided by
YAESU museum

Downloaded by
RadioAmateur.EU

Specifications

Note

Exploded View

Case ASSY

REF.	VXSTD P/N	Description	Qty.
①	U31408007	OVAL HEAD SCREW M4X8B	9
②	U24305007	BIND HEAD TAPTITE-B M3X5B	4
③	U31410020	OVAL HEAD SCREW M4X10SUS	2
④	U31306007	OVAL HEAD SCREW M3X6B	7
⑤	U24425007	BIND HEAD TAPTITE-B M4X25B	2
⑥	U70005002	PLAIN WASHER FW5NI	2
⑦	U24410007	BIND HEAD TAPTITE-B M4X10B	2
⑧	U24306002	BIND HEAD TAPTITE-B M3X6NI	15
⑨	U34308001	FLAT HEAD TAPTITE-B M3X8	4

Non-designated parts are available only as part of a designated assembly.

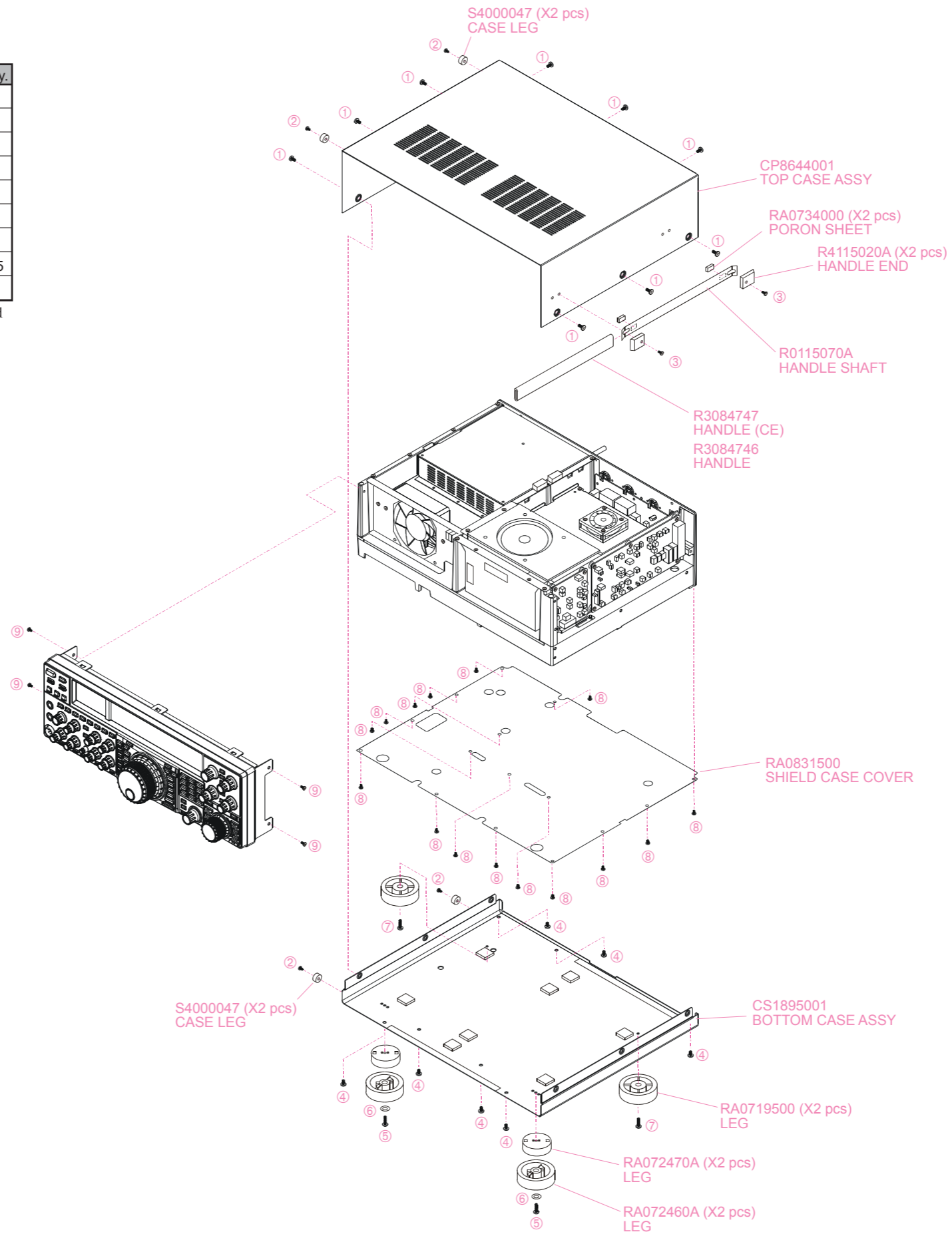

Exploded View

Panel ASSY (1/2)

REF.	VXSTD P/N	Description	Qty.
①	U24205001	BIND HEAD TAPTITE-B M2.6X5	1
②	U24214001	BIND HEAD TAPTITE-B M2.6X14	2

Non-designated parts are available only as part of a designated assembly.

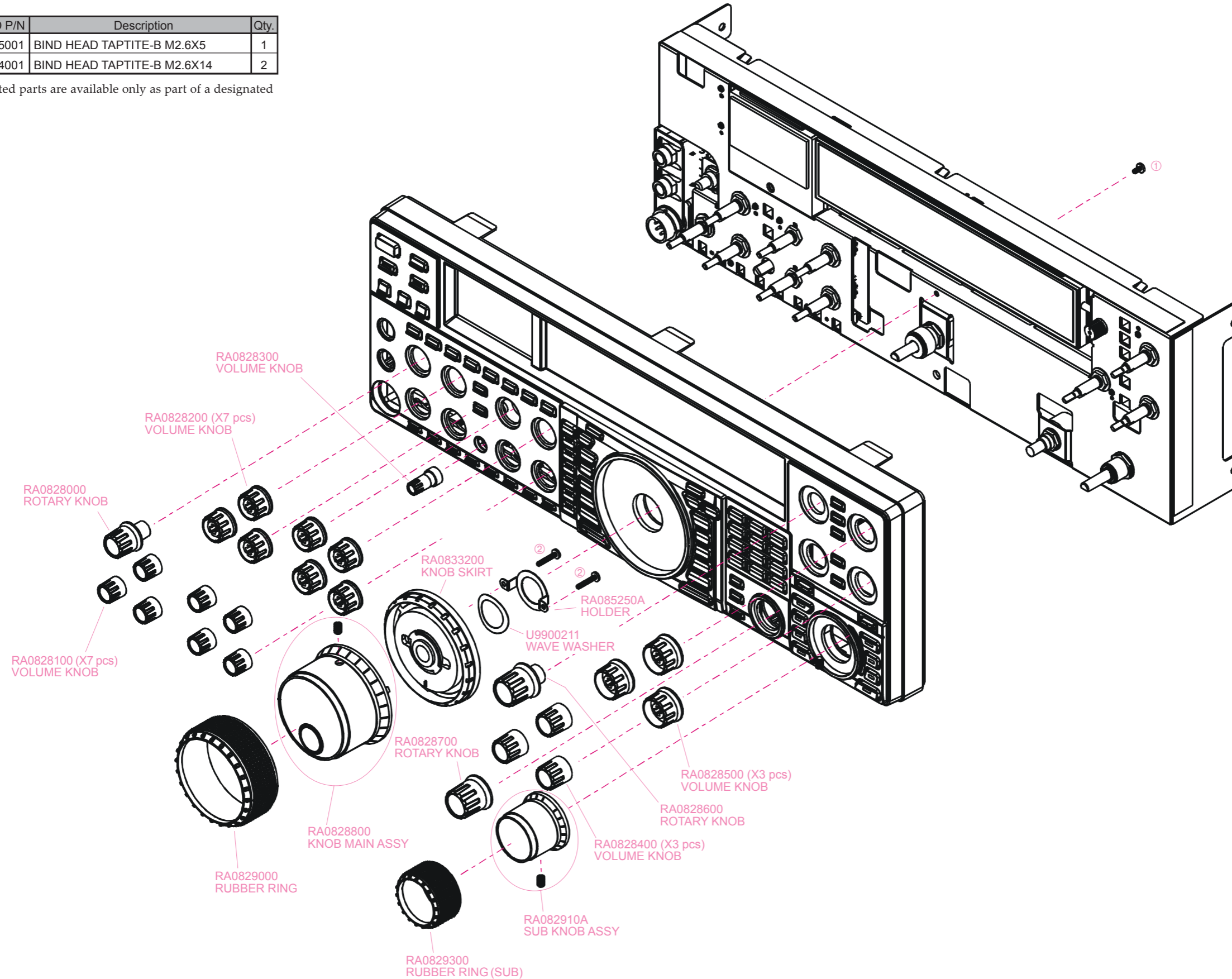

Exploded View

Panel ASSY (2/2)

Provided by
YAESU museum
Downloaded by
RadioAmateur.EU

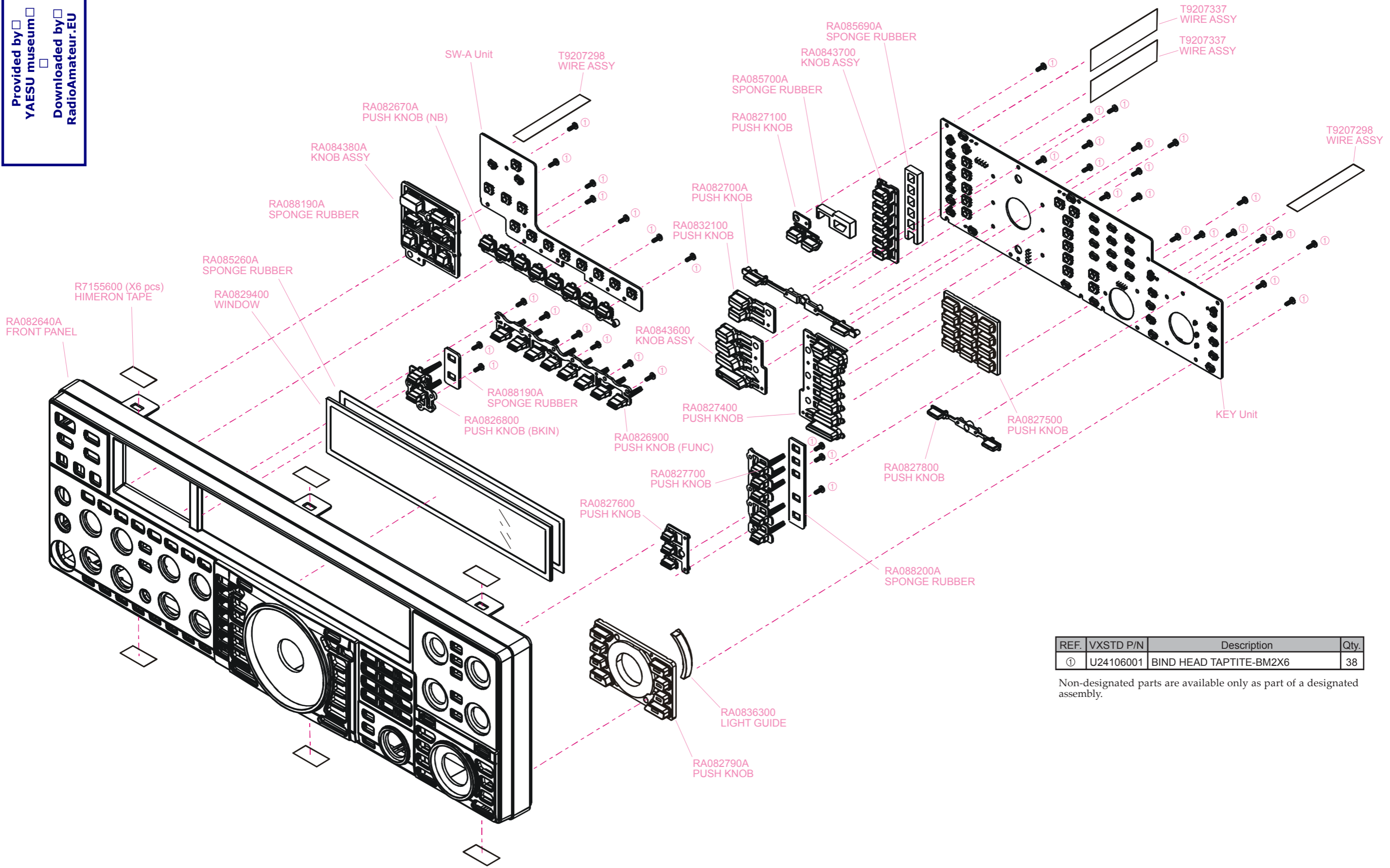

REF.	VXSTD P/N	Description	Qty.
①	U24106001	BIND HEAD TAPTITE-BM2X6	38

Non-designated parts are available only as part of a designated assembly.

Exploded View

CHASSIS ASSY (1/4)

REF.	VXSTD P/N	Description	Qty.
①	U24306002	BIND HEAD TAPTITE-B M3X6NI	42
②	U34308001	FLAT HEAD TAPTITE-B M3X8	4
③	U03308002	SEMS SCREW ASM3X8NI	20
④	U44308002	PAN HEAD TAPTITE-B M3X8NI	8
⑤	U03306002	SEMS SCREW ASM3X6NI	4
⑥	U52415002	HEX HEAD BOLT M4X15NI	1
⑦	U70005002	PLAIN WASHER FW5NI	2
⑧	U72005002	TOOTHED LOCK WASHER OW5NI	1

Non-designated parts are available only as part of a designated assembly.

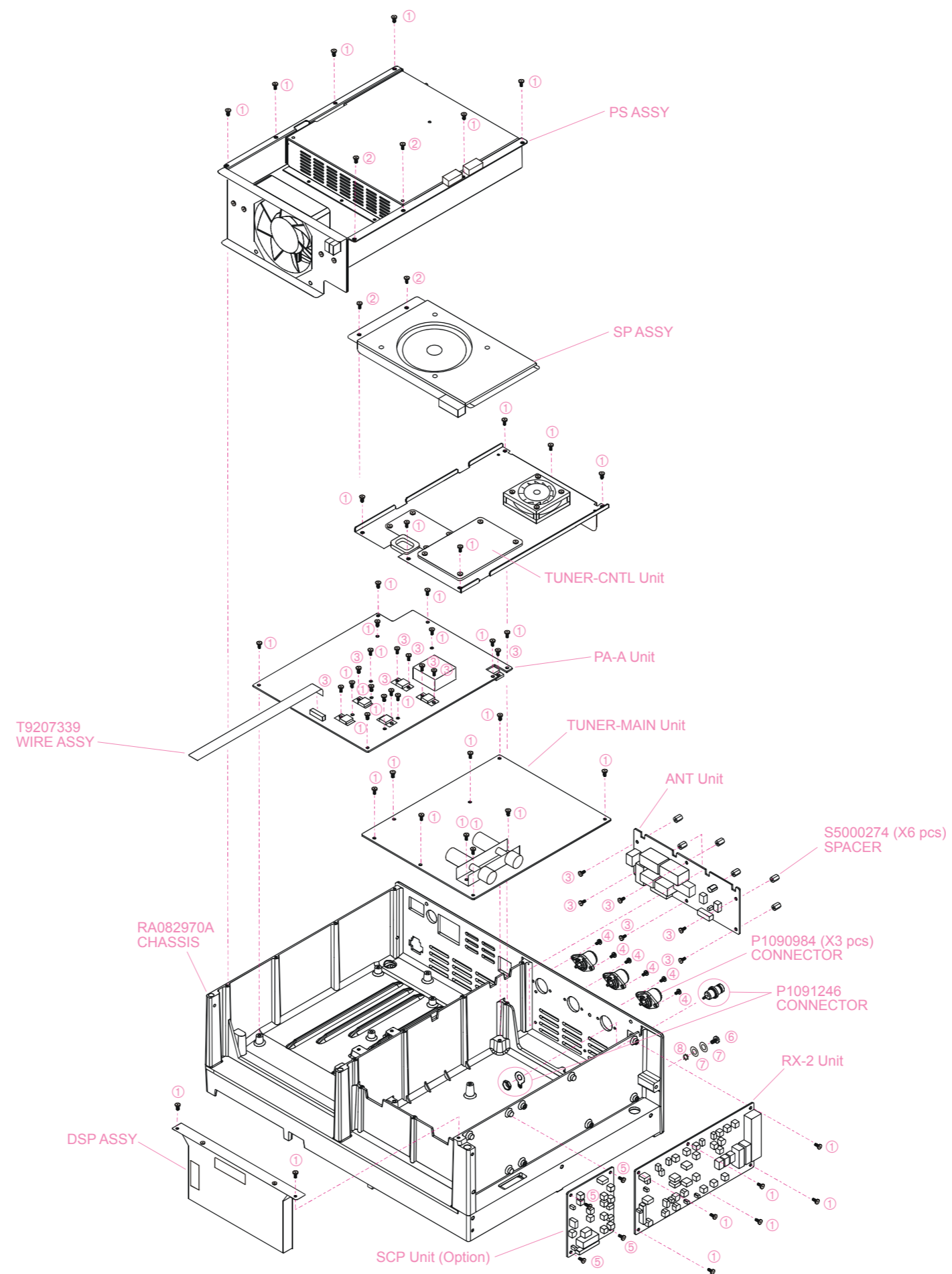

Exploded View

CHASSIS ASSY (2/4)

PS ASSY

REF.	VXSTD P/N	Description	Qty.
①	U24306002	BIND HEAD TAPTITE-B M3X6NI	12
②	U04330007	SEMS SCREW HSM3X30B	4

Non-designated parts are available only as part of a designated assembly.

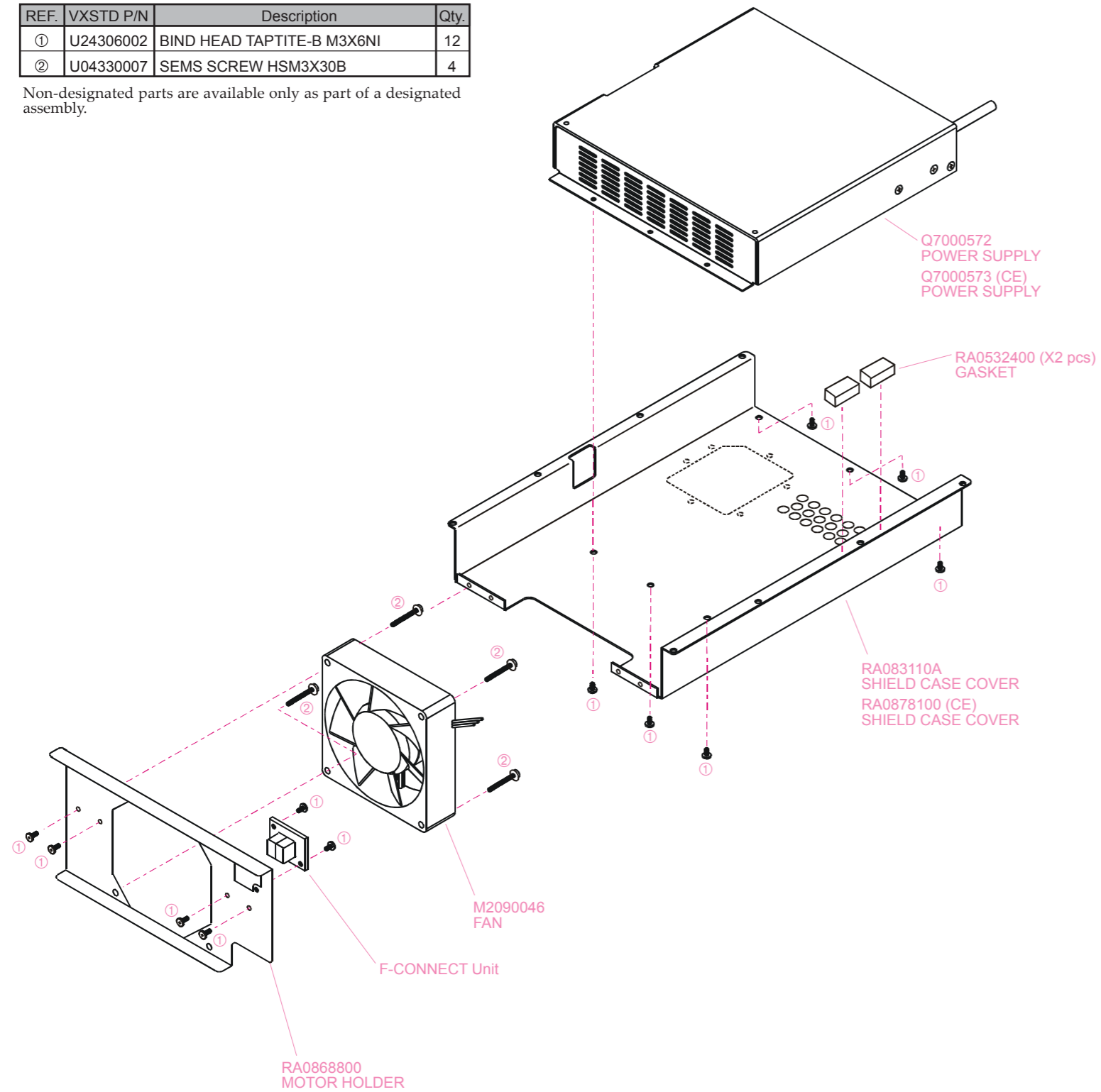

DSP ASSY

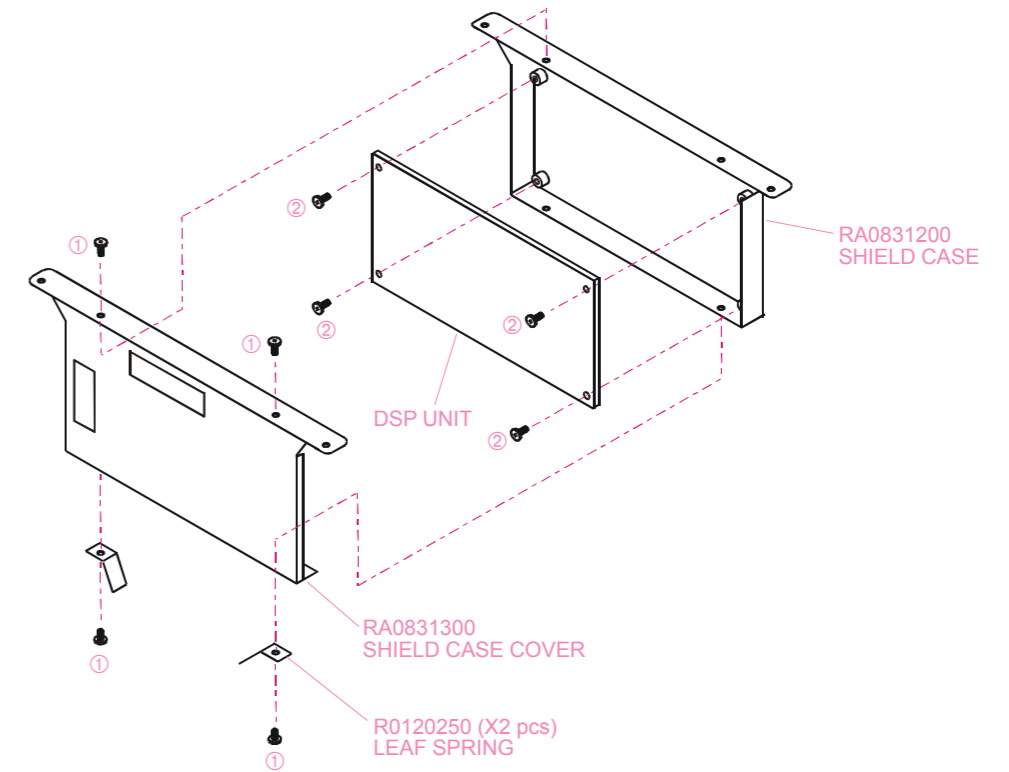

REF.	VXSTD P/N	Description	Qty.
①	U24206002	BIND HEAD TAPTITE-B M2.6X6NI	4
②	U03306002	SEMS SCREW ASM3X6NI	4

Non-designated parts are available only as part of a designated assembly.

SP ASSY

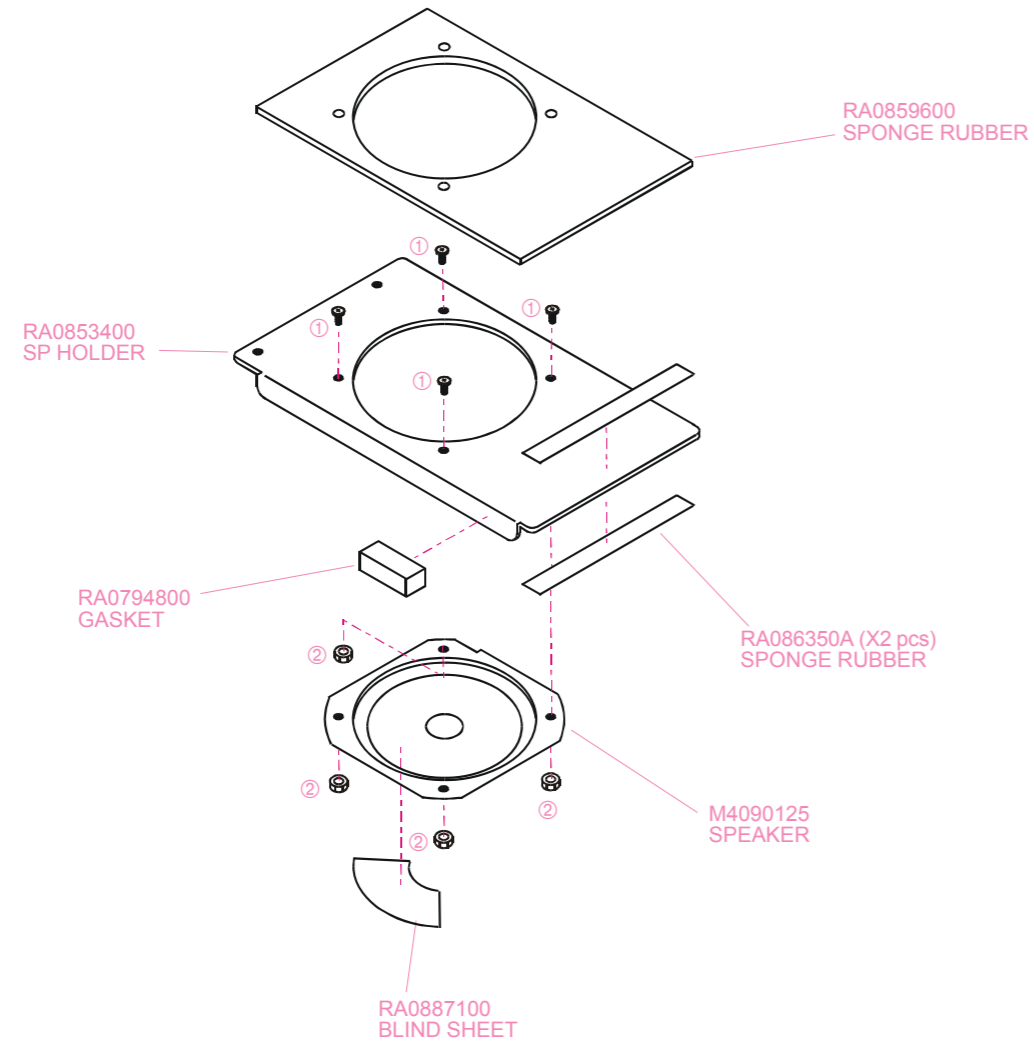

REF.	VXSTD P/N	Description	Qty.
①	U30310002	FLAT HEAD SCREW M3X10NI	4
②	U66300002	FLANGE NUT N3NI	4

Non-designated parts are available only as part of a designated assembly.

TUNER ASSY

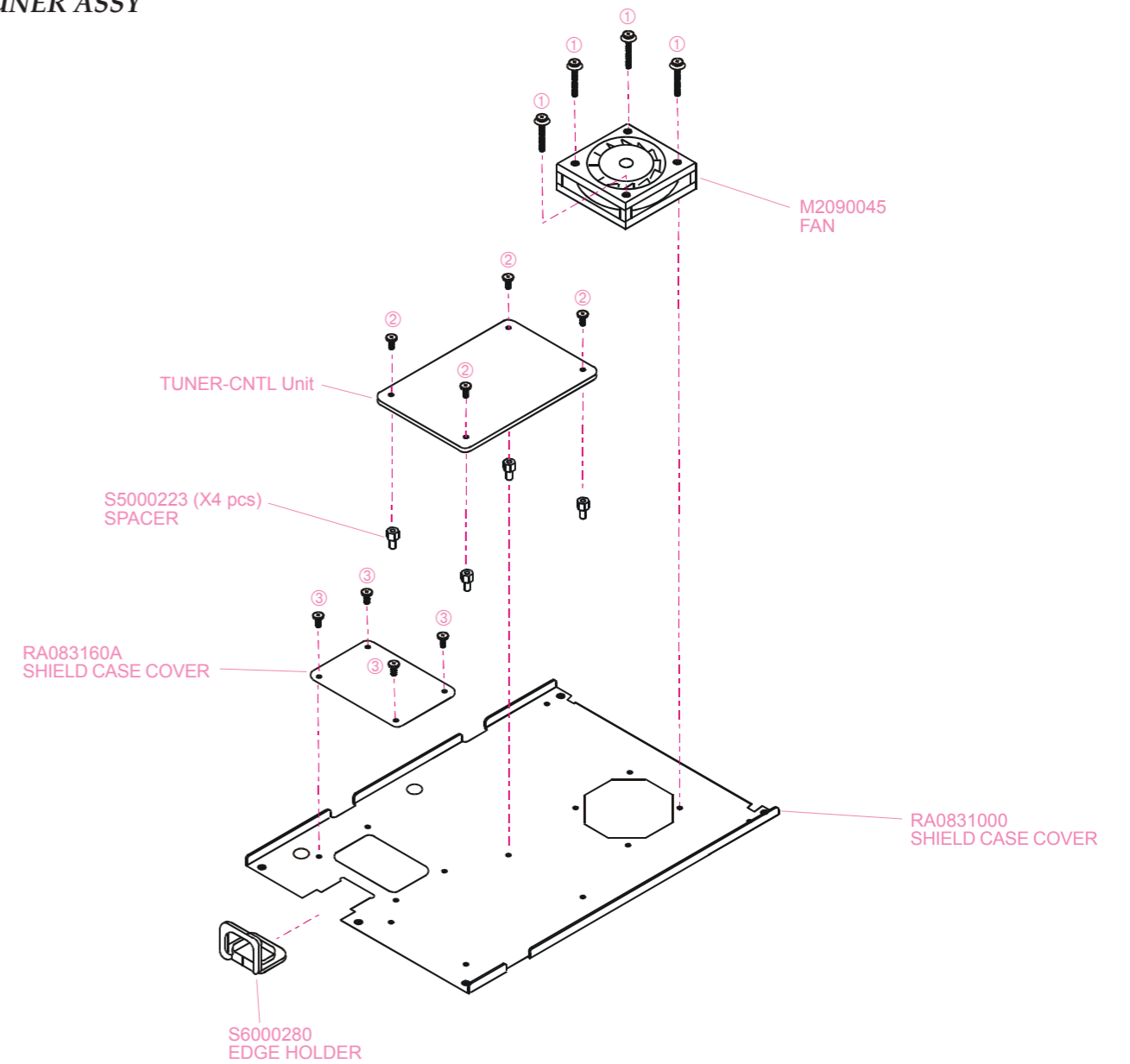

REF.	VXSTD P/N	Description	Qty.
①	U04325002	SEMS SCREW HSM3X25NI	4
②	U03306002	SEMS SCREW ASM3X6NI	4
③	U24306002	BIND HEAD TAPTITE-B M3X6NI	4

Non-designated parts are available only as part of a designated assembly.

Exploded View

CHASSIS ASSY (4/4)

REF.	VXSTD P/N	Description	Qty.
①	U24306002	BIND HEAD TAPTITE-B M3X6NI	2
②	U03306002	SEMS SCREW ASM3X6NI	4

Non-designated parts are available only as part of a designated assembly.

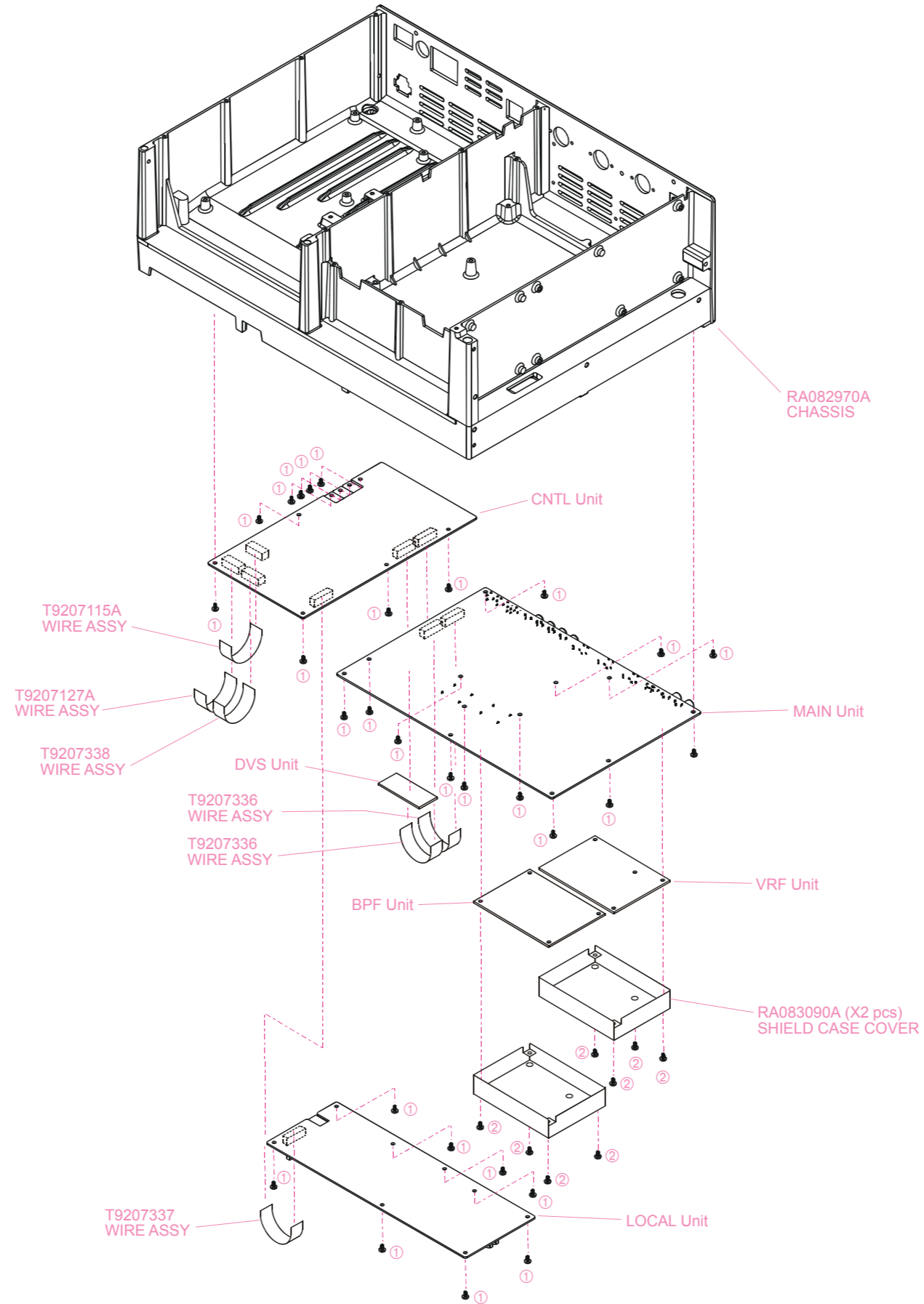

BLOCK-DIAGRAM

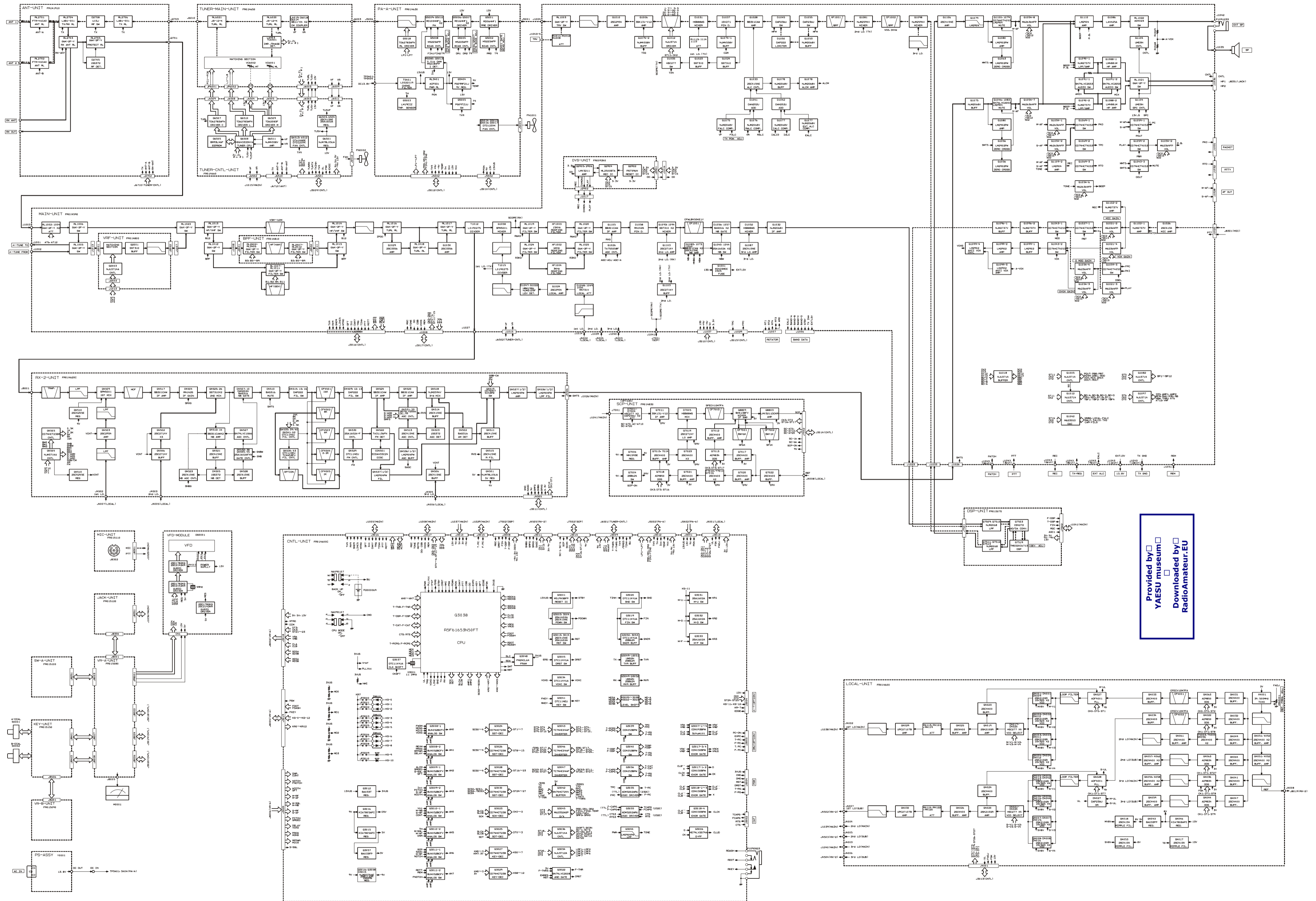

Provided by YAESU museum
Downloaded by RadioAmateur.EU

CONNECTION DIAGRAM

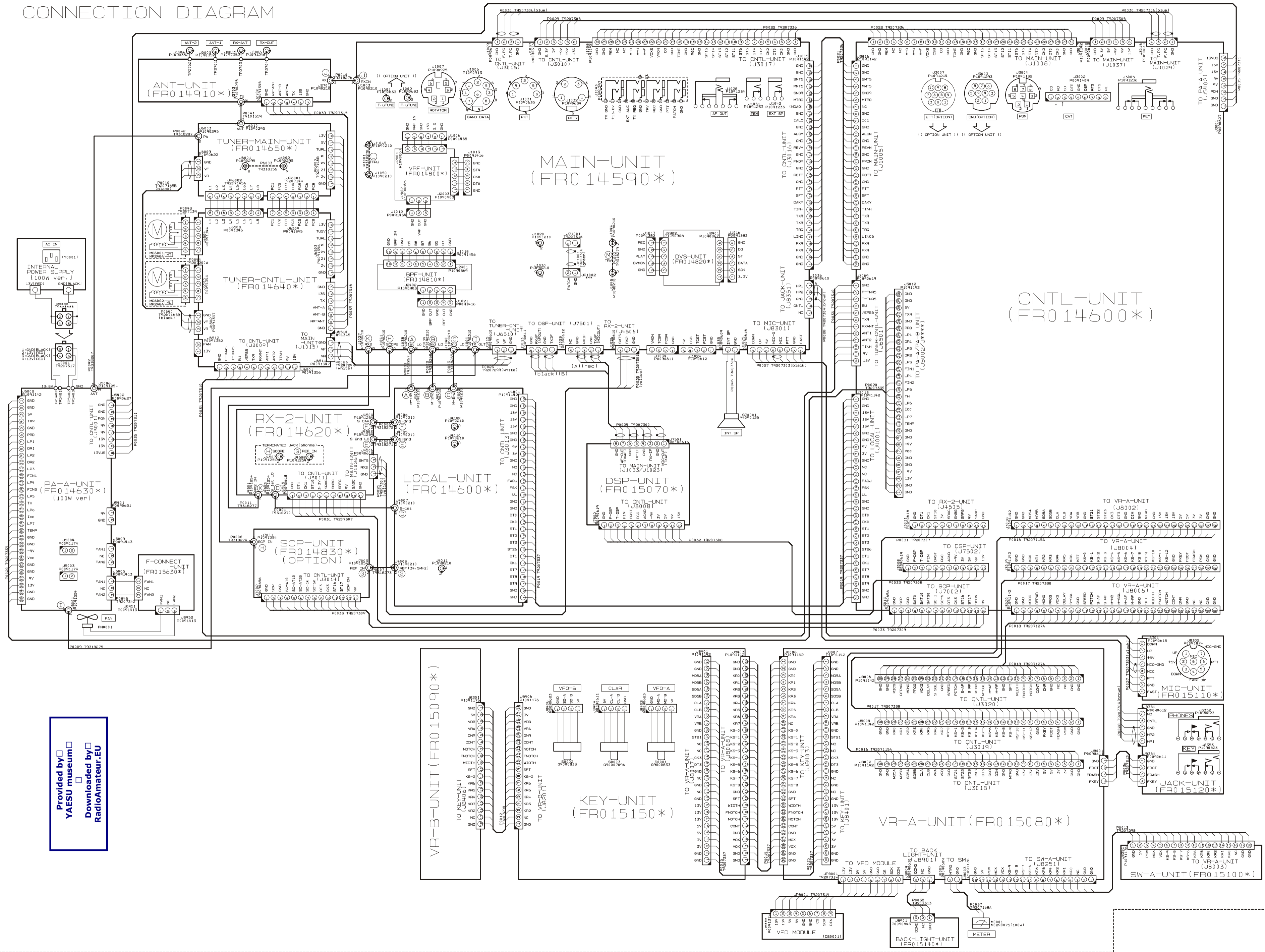

Provided by YAESU museum Downloaded by RadioAmateur.EU

Introduction and Precautions

The following procedures cover adjustments that are not normally required once the transceiver has left the factory. However, If a problem occurs during normal operation due to component failure; realignment may be required after the faulty components have been replaced.

We recommend that authorized Vertex Standard Technicians, who are experienced with the circuitry and fully equipped to repair and align our products, perform repairs. If a fault is suspected, contact the selling dealer for instructions regarding repair. Authorized Vertex Standard Technicians have the latest information to align all circuits and make complete performance checks to ensure compliance with factory specifications after repairs.

Those who do undertake any of the following alignments are cautioned and proceed at their own risk. Problems caused by unauthorized attempts at realignment are not covered by the warranty policy.

Vertex Standard must reserve the right to change circuits and alignment procedures in the interest of improved performance, without notifying owners.

Under no circumstances should any alignment be attempted unless the normal functions and operation of the transceiver are clearly understood, the cause of the malfunction has been clearly identified and all faulty components replaced. The need for realignment should be determined to be absolutely necessary.

The following test equipment (and a thorough familiarity with its correct use) is necessary for correct realignment. Most steps do not require all of the equipment listed. The interactions of some adjustments may require that more complex adjustments be performed in a sequence. Do not attempt to perform only a single step unless it is clearly isolated electrically from all other steps. Have all test equipment ready before beginning, and follow all of the steps in a section in the order they are presented.

Required Test Equipment

- RF Signal Generator
- AF Signal Generator
- Spectrum Analyzer good to at least 1 GHz.
- Frequency Counter
- SINAD Meter
- RF Millivoltmeter
- Digital DC Voltmeter (high-Z, 1 M-Ohm/V)
- DC Voltmeter
- DC Ammeter (20 A)
- Ohmmeter
- DMU-2000 Data Management Unit
- 50-Ohm Dummy Load (100 watts)
- 100-Ohm Dummy Load (100 watts)
- 150-Ohm Dummy Load (100 watts)
- In-Line Wattmeter (100 watts, 50-Ohm)
- Linear Detector
- RF Coupler
- 4-Ohm AF Dummy Load (3 watts)

Alignment Preparation & Precautions

A 50-ohm RF Dummy load and in-line wattmeter must be connected to the "ANT 1" jack in all procedures that call for transmission, except where specified otherwise. Correct alignment is not possible with an antenna.

After completing one step, read the following step to determine whether the same test equipment will be required. If not, remove the unneeded test equipment before proceeding. (except the dummy load and wattmeter).

Correct alignment requires that the ambient temperature be maintained constant between 68 °F ~ 86 °F (20 °C ~ 30 °C). When the transceiver is brought into the shop from a hot or cold environment, it should be allowed time to come to room temperature before alignment. Also, the test equipment must be thoroughly warmed up before beginning.

Whenever possible, alignments should be made with oscillator shields and circuit boards firmly affixed in place. Also, the test equipment must be thoroughly warmed up before beginning.

Note: Signal levels in dB referred to in this procedure are based on 0 dB μ = 0.5 μ V (closed circuit).

Alignment

Analog Meter Adjustment

- ❑ Press and hold in the [1(1.8)], [2(3.5)], and [3(7)] keys, while turning the radio on, to enter the alignment mode.
- ❑ Rotate the Main Tuning Dial knob to select the alignment parameter “A01 FSC.”
- ❑ Rotate the [SUB(VFO-B)] knob so that the Main S-meter deflects to full scale.
- ❑ Press and hold in the [MENU] button for 2 seconds to save the new setting and exit from the alignment mode.

SHIFT/WIDTH Knob

Zero (Center) Adjustment

- ❑ Set the SHIFT/WIDTH knobs to the 12-o’clock position.
- ❑ Set the operating mode to “USB.”
- ❑ Press and hold in the [1(1.8)], [2(3.5)], and [3(7)] keys, while turning the radio on, to enter the alignment mode.
- ❑ Rotate the Main Tuning Dial knob to select the alignment parameter “A02 Sft.”
- ❑ Rotate the [SUB(VFO-B)] knob so that the IF SHIFT frequency is set to “ ± 0.00 ” on the external display. The center point (± 0.00) is broad (17 points). Therefore, set the [SUB(VFO-B)] knob to the center of this broad range.
- ❑ Rotate the Main Tuning Dial knob to select the alignment parameter “A03 udt.”
- ❑ Rotate the [SUB(VFO-B)] knob so that the IF bandwidth is set to “2.4 kHz” on the external display. The IF bandwidth (2.4 kHz) is broad (24 points). Therefore, set the [SUB(VFO-B)] knob to the center of this broad range.
- ❑ Press and hold in the [MENU] button for 2 seconds to save the new setting and exit from the alignment mode.

VDD Meter Adjustment

- ❑ Connect the DC voltmeter to pin 6 of J5402 on the PA-A Unit.
- ❑ Switch the external display to “SWR Monitor” page.
- ❑ Press and hold in the [1(1.8)], [2(3.5)], and [3(7)] keys, while turning the radio on, to enter the alignment mode.
- ❑ Rotate the Main Tuning Dial knob to select the alignment parameter “A04 vdd.”
- ❑ Press the [ENT] key, then rotate the [SUB(VFO-B)] knob so that the VDD meter (Main S-meter) reading is the same as that on the DC voltmeter.
- ❑ Rotate the [VRF] knob so that the VDD meter (on the external display) reading is same as that on the DC voltmeter.
- ❑ Press and hold in the [MENU] button for 2 seconds to save the new setting and exit from the alignment mode.

2nd Local Oscillator (Main) Adjustment

- ❑ Disconnect the coaxial cable from J4004 on the LOCAL Unit, then connect the Frequency counter to J4004.
- ❑ Press and hold in the [1(1.8)], [2(3.5)], and [3(7)] keys, while turning the radio on, to enter the alignment mode.
- ❑ Rotate the Main Tuning Dial knob to select the alignment parameter "A15 FrE."
- ❑ Rotate the [SUB(VFO-B)] knob so that the Frequency counter reading is "69.000 MHz."
- ❑ Press and hold in the [MENU] button for 2 seconds to save the new setting and exit from the alignment mode.
- ❑ Disconnect the Frequency counter from J4004, then connect the RF millivoltmeter to J4004.
- ❑ Adjust T4003 and T4004 on the LOCAL Unit for maximum deflection on the RF millivoltmeter (more than -5 dBm).
- ❑ Disconnect the RF millivoltmeter from J4004, then re-connect the coaxial cable to J4004.

PLL (Main) Adjustment

- ❑ Connect the Digital DC voltmeter (high-Z) to TP4003 on the LOCAL Unit.
- ❑ Disconnect the coaxial cable from J4002 on the LOCAL Unit, then connect the RF millivoltmeter to J4002.

- ❑ Referring to the table below, adjust the listed components for the required voltage, or confirm that the correct voltage is present on each frequency listed.

VFO-A FREQUENCY	ADJUST / CONFIRM	DC VOLTMETER	RF MILLIVOLTMETER
11.495 MHz	Adjust TC4001	5.0 V ±0.1 V	At least +3 dBm
0.03 MHz	Confirm	At least 0.8 V	At least +3 dBm
25.495 MHz	Adjust TC4002	5.0 V ±0.1 V	At least +3 dBm
11.500 MHz	Confirm	At least 0.8 V	At least +3 dBm
41.495 MHz	Adjust TC4003	5.0 V ±0.1 V	At least +3 dBm
25.500 MHz	Confirm	At least 0.8 V	At least +3 dBm
60.000 MHz	Adjust TC4004	5.0 V ±0.1 V	At least +3 dBm
41.500 MHz	Confirm	At least 0.8 V	At least +3 dBm

- ❑ Disconnect the RF millivoltmeter from J4002, then re-connect the coaxial cable to J4002.

PLL (Sub) Adjustment

- ❑ Connect the Digital DC voltmeter (high-Z) to TP4004 on the LOCAL Unit.
- ❑ Disconnect the coaxial cable from J4007 on the LOCAL Unit, then connect the RF millivoltmeter to J4007.
- ❑ Referring to the table below, adjust the listed components for the required voltage, or confirm that the correct voltage is present on each frequency listed.

VFO-B FREQUENCY	ADJUST / CONFIRM	DC VOLTMETER	RF MILLIVOLTMETER
11.495 MHz	Adjust TC4005	5.0 V ±0.1 V	At least +3 dBm
0.03 MHz	Confirm	At least 0.8 V	At least +3 dBm
25.495 MHz	Adjust TC4006	5.0 V ±0.1 V	At least +3 dBm
11.500 MHz	Confirm	At least 0.8 V	At least +3 dBm
41.495 MHz	Adjust TC4007	5.0 V ±0.1 V	At least +3 dBm
25.500 MHz	Confirm	At least 0.8 V	At least +3 dBm
60.000 MHz	Adjust TC4008	5.0 V ±0.1 V	At least +3 dBm
41.500 MHz	Confirm	At least 0.8 V	At least +3 dBm

- ❑ Disconnect the RF millivoltmeter from J4007, then re-connect the coaxial cable to J4007.

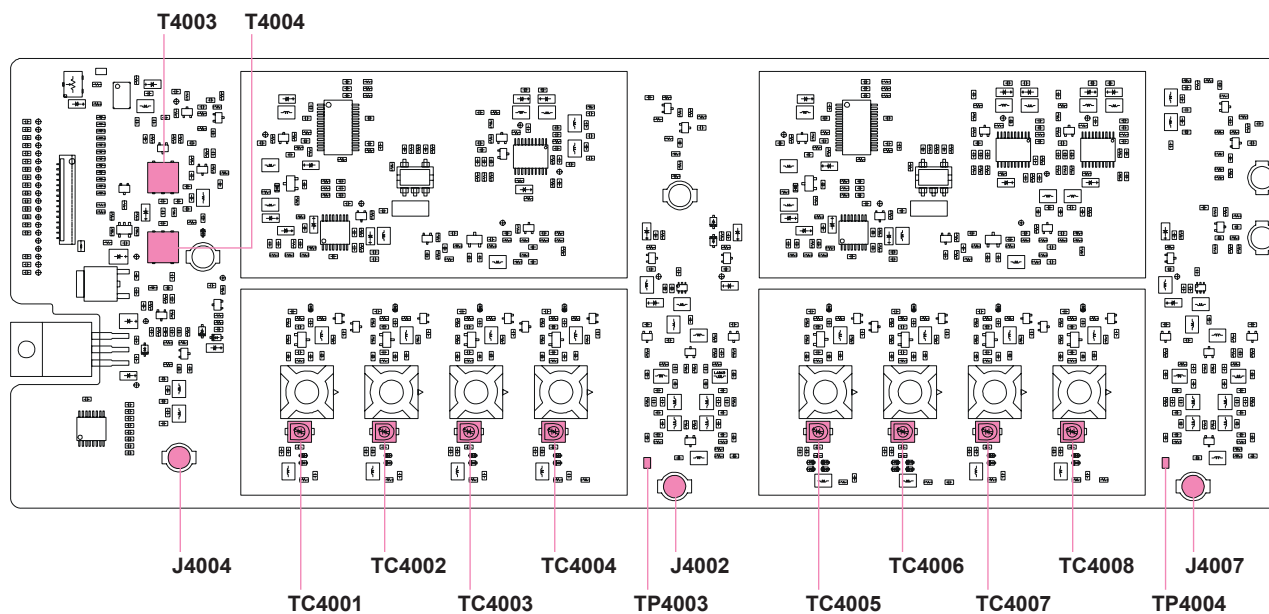

LOCAL UNIT ALIGNMENT POINTS

Alignment

Main Receiver Adjustment

1st Local Oscillator Adjustment

- Set the following controls as indicated:
 - [IPO] button: AMP1
 - [ATT] button: OFF
 - [VRF] button: THRU
 - [R.FLT] button: AUTO
 - [AGC] button: AUTO
 - [RF GAIN] knob: Fully clockwise
 - [MODE] button: CW
- Connect the RF millivoltmeter to TP1073 on the MAIN Unit.
- Press and hold in the [1(1.8)], [2(3.5)], and [3(7)] keys, while turning the radio on, to enter the alignment mode.
- Select the appropriate “Alignment Parameter” using the Main Tuning Dial knob per the chart below, and adjust the [SUB(VFO-B)] knob for the corresponding RF millivoltmeter reading at each frequency.

ALIGNMENT PARAMETER	VFO-A FREQUENCY	RF MILLIVOLTMETER
A08 L18	1.850 MHz	0.96 Vrms (+0 Vrms/-0.04 Vrms)
A09 L35	3.570 MHz	0.96 Vrms (+0 Vrms/-0.04 Vrms)
A10 L7	7.100 MHz	0.96 Vrms (+0 Vrms/-0.04 Vrms)
A11 L14	14.200 MHz	0.84 Vrms (+0 Vrms/-0.04 Vrms)
A12 L21	21.200 MHz	0.84 Vrms (+0 Vrms/-0.04 Vrms)
A13 L28	28.700 MHz	0.84 Vrms (+0 Vrms/-0.04 Vrms)
A14 L50	51.500 MHz	0.5 Vrms (± 0.05 Vrms)

- Press and hold in the [MENU] button for 2 seconds to save the new setting and exit from the alignment mode.

2nd/3rd Local Level Adjustment

- Connect the RF millivoltmeter to TP1021 on the MAIN Unit.
- Adjust T1034 on the MAIN Unit for maximum deflection on the RF millivoltmeter (more than +10 dBm).
- Connect the RF millivoltmeter to TP1018 on the MAIN Unit.
- Adjust T1028 on the MAIN Unit for maximum deflection on the RF millivoltmeter (more than +3 dBm).

IF Transformer Adjustment

- Set the following controls as indicated:
 - [ANT 1/2] button: ANT 1
 - [IPO] button: AMP1
 - [ATT] button: OFF
 - [R.FLT] button: 15 kHz
 - [AGC] button: AUTO
 - [RF GAIN] knob: Fully clockwise
 - [VRF] button: THRU
- Set the Main Band (VFO-A) frequency to 14.200 MHz in the CW mode.
- Connect the AF millivoltmeter and 4 Ohm dummy load to the EXT SP jack.
- Connect the RF Signal Generator to the “ANT 1” jack, then set the output level to 0 dB μ at the 14.200 MHz.
- Adjust T1031, T1036, T1035, T1038, T1032, T1023, and T1019 on the MAIN Unit in succession several times for maximum deflection on the AF millivoltmeter.

If the Main S-meter deflects while adjusting, reduce the RF Signal Generator output so that the Main S-meter does not deflect.

MCF Adjustment

- Set the following controls as indicated:
 - [ANT 1/2] button: ANT 1
 - [IPO] button: AMP1
 - [ATT] button: OFF
 - [AGC] button: AUTO
 - [RF GAIN] knob: Fully clockwise
 - [VRF] button: THRU
- Set the Main Band (VFO-A) frequency to 14.200 MHz in the CW mode.
- Connect the AC millivoltmeter, SINAD meter, and 4 Ohm dummy load to the EXT SP jack.
- Connect the RF Signal Generator to the “ANT 1” jack, then set the output level to 0 dB μ at the 14.200 MHz.
- Set the Roofing filter bandwidth to “3 kHz” by pressing the [R.FLT] button.
- Adjust TC1002 and T1040 on the MAIN Unit in succession several times for maximum deflection on the AC millivoltmeter.

If the Main S-meter deflects while adjusting, reduce the RF Signal Generator output so that the Main S-meter does not deflect.

- Set the Roofing filter bandwidth to “6 kHz” by pressing the [R.FLT] button.

- ❑ Adjust TC1001 and T1030 on the MAIN Unit in succession several times for maximum deflection on the AC millivoltmeter.
If the Main S-meter deflects while adjusting, reduce the RF Signal Generator output so that the Main S-meter does not deflect.
- ❑ Set the Main Band (VFO-A) frequency to 50.000 MHz in the FM mode, and set the IPO to "AMP2" by pressing the [IPO] button.
- ❑ Set the Roofing filter bandwidth to "15 kHz" by pressing the [R.FLT] button, and set the IPO to "AMP2" by pressing the [IPO] button.
- ❑ Set the RF Signal Generator output to 0 dB μ at the 50.000 MHz.
- ❑ Adjust T1031 and T1036 on the MAIN Unit in succession several times for maximum deflection on the SINAD meter.
If the Main S-meter deflects while adjusting, reduce the RF Signal Generator output so that the Main S-meter does not deflect.

IF Trap Adjustment

- ❑ Set the following controls as indicated:
[ANT 1/2] button: ANT 1
[IPO] button: AMP1
[ATT] button: OFF
[R.FLT] button: AUTO
[AGC] button: AUTO
[RF GAIN] knob: Fully clockwise
[VRF] button: THRU
- ❑ Set the Main Band (VFO-A) frequency to 50.000 MHz in the CW mode.
- ❑ Connect the AC millivoltmeter and 4 Ohm dummy load to the EXT SP jack.
- ❑ Connect the RF Signal Generator to the "ANT 1" jack, then set the output level to 60 dB μ at the 69.450 MHz.
- ❑ Adjust T1011 on the MAIN Unit for minimum deflection on the AC millivoltmeter.
If the Main S-meter deflects while adjusting, reduce the RF Signal Generator output so that the Main S-meter does not deflect.

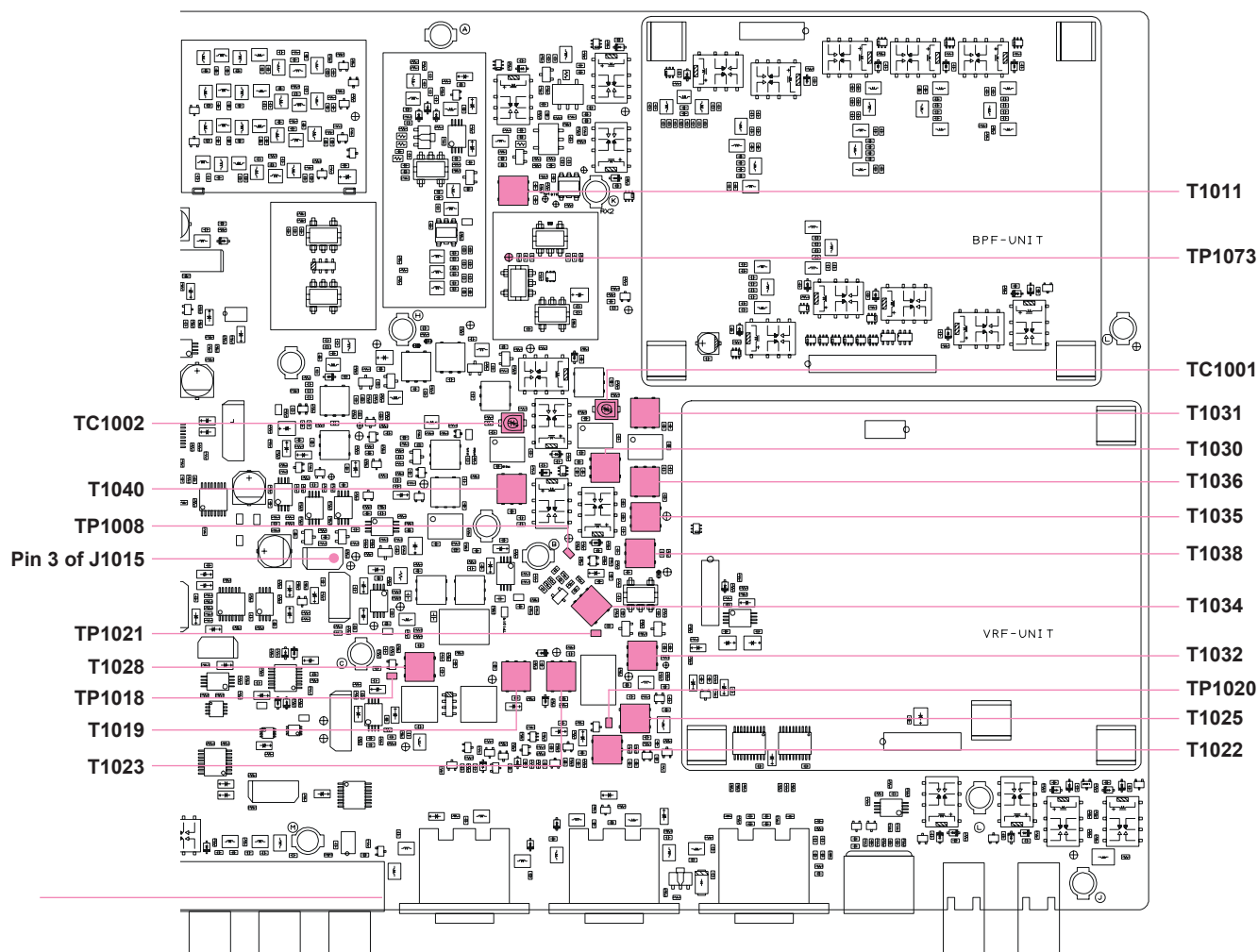

MAIN UNIT (RECEIVER SECTION) ALIGNMENT POINTS

Alignment

Noise Blanker Circuit Adjustment

- ❑ Set the following controls as indicated:
 - [ANT 1/2] button: ANT 1
 - [IPO] button: AMP1
 - [ATT] button: OFF
 - [R.FLT] button: AUTO
 - [AGC] button: AUTO
 - [NB] button: ON (for short-duration pulse noise)
 - [NB] knob: Fully clockwise
 - [RF GAIN] knob: Fully clockwise
 - [VRF] button: THRU
- ❑ Set the Main Band (VFO-A) frequency to 14.200 MHz in the CW mode.
- ❑ Connect the DC voltmeter to TP1020 on the MAIN Unit.
- ❑ Connect the RF Signal Generator to the “ANT 1” jack, then set the output level to 30 dB μ at the 14.200 MHz.
- ❑ Adjust T1025 and T1022 on the MAIN Unit for minimum deflection on the DC voltmeter.
- ❑ Turn the NB to “OFF” by pressing the [NB] button.

Scope Circuit Adjustment

- ❑ Set the following controls as indicated:
 - [ANT 1/2] button: ANT 1
 - [IPO] button: AMP1
 - [ATT] button: OFF
 - [R.FLT] button: AUTO
 - [AGC] button: AUTO
 - [RF GAIN] knob: Fully clockwise
 - [VRF] button: THRU
- ❑ Set the Main Band (VFO-A) frequency to 14.200 MHz in the CW mode.
- ❑ Disconnect the coaxial cable from J1041 on the MAIN Unit, then connect the RF millivoltmeter to J1041.
- ❑ Connect the RF Signal Generator to the “ANT 1” jack, then set the output level to 90 dB μ at the 14.200 MHz.
- ❑ Adjust T1039 on the MAIN Unit for maximum deflection on the RF millivoltmeter.
- ❑ Disconnect the RF millivoltmeter from J1041, then re-connect the coaxial cable to J1041.

RF AGC Adjustment

- ❑ Set the following controls as indicated:
 - [ANT 1/2] button: ANT 1
 - [IPO] button: AMP1
 - [ATT] button: OFF
 - [R.FLT] button: 6 kHz
 - [AGC] button: AUTO
 - [PITCH] knob: 800 Hz
 - [RF GAIN] knob: Fully clockwise
 - [VRF] button: THRU
 - [MODE] button: CW
- ❑ Connect the RF Signal Generator to the “ANT 1” jack, and connect the Digital DC voltmeter (high-Z) to TP1008 on the MAIN Unit.
- ❑ Press and hold in the [1(1.8)], [2(3.5)], and [3(7)] keys, while turning the radio on, to enter the alignment mode.
- ❑ Select the appropriate “Alignment Parameter” using the Main Tuning Dial knob per the chart below, then set the RF Signal Generator output to each frequency & level, and adjust the [SUB(VFO-B)] knob for the corresponding DC voltmeter reading at each frequency.

ALIGNMENT PARAMETER	RF SIGNAL GENERATOR	VFO-A FREQUENCY	DC VOLTMETER
B01 rGc	1.900 MHz, 96 dB μ	1.900 MHz	1.5 V (-0V/+0.05V)
B02 rGc	3.750 MHz, 96 dB μ	3.750 MHz	1.5 V (-0V/+0.05V)
B03 rGc	7.150 MHz, 96 dB μ	7.150 MHz	1.5 V (-0V/+0.05V)
B04 rGc	10.125 MHz, 96 dB μ	10.125 MHz	1.5 V (-0V/+0.05V)
B05 rGc	14.175 MHz, 96 dB μ	14.175 MHz	1.5 V (-0V/+0.05V)
B06 rGc	18.117 MHz, 96 dB μ	18.117 MHz	1.5 V (-0V/+0.05V)
B07 rGc	21.255 MHz, 96 dB μ	21.255 MHz	1.5 V (-0V/+0.05V)
B08 rGc	24.940 MHz, 96 dB μ	24.940 MHz	1.5 V (-0V/+0.05V)
B09 rGc	28.850 MHz, 96 dB μ	28.850 MHz	1.5 V (-0V/+0.05V)
B10 rGc	52.000 MHz, 96 dB μ	52.000 MHz	1.5 V (-0V/+0.05V)

- ❑ Press and hold in the [MENU] button for 2 seconds to save the new setting and exit from the alignment mode.

IF Gain Adjustment

- ❑ Set the following controls as indicated:
 - [ANT 1/2] button: ANT 1
 - [IPO] button: AMP1
 - [ATT] button: OFF
 - [R.FLT] button: 6 kHz
 - [AGC] button: AUTO
 - [PITCH] knob: 700 Hz
 - [RF GAIN] knob: Fully clockwise
 - [VRF] button: THRU
 - [MODE] button: CW
- ❑ Connect the AC millivoltmeter and 4 Ohm dummy load to the EXT SP jack.
- ❑ Connect the RF Signal Generator to the “ANT 1” jack, then set the output level to 36 dB μ at the 1.900 MHz.
- ❑ Set the Main Band (VFO-A) frequency to 1.900 MHz in the CW mode.
- ❑ Press and hold in the [1(1.8)], [2(3.5)], and [3(7)] keys, while turning the radio on, to enter the alignment mode.
- ❑ Adjust the Main [AF GAIN] knob so that the AC millivoltmeter reading is “0 dB.”
- ❑ Select the appropriate “Alignment Parameter” using the Main Tuning Dial knob per the chart below, then set the RF Signal Generator output to each frequency & level, and adjust the [SUB(VFO-B)] knob for the corresponding AC millivoltmeter reading at each frequency.

ALIGNMENT PARAMETER	RF SIGNAL GENERATOR	VFO-A FREQUENCY	AC MILLIVOLTMETER
b11 iGn	1.900 MHz, 96 dB μ	1.900 MHz	-1.5 dB (± 0.5 dB)
b12 iGn	3.750 MHz, 96 dB μ	3.750 MHz	-1.5 dB (± 0.5 dB)
b13 iGn	7.150 MHz, 96 dB μ	7.150 MHz	-1.5 dB (± 0.5 dB)
b14 iGn	10.125 MHz, 96 dB μ	10.125 MHz	-1.5 dB (± 0.5 dB)
b15 iGn	14.175 MHz, 96 dB μ	14.175 MHz	-1.5 dB (± 0.5 dB)
b16 iGn	18.117 MHz, 96 dB μ	18.117 MHz	-1.5 dB (± 0.5 dB)
b17 iGn	21.255 MHz, 96 dB μ	21.255 MHz	-1.5 dB (± 0.5 dB)
b18 iGn	24.940 MHz, 96 dB μ	24.940 MHz	-1.5 dB (± 0.5 dB)
b19 iGn	28.850 MHz, 96 dB μ	28.850 MHz	-1.5 dB (± 0.5 dB)
b20 iGn	52.000 MHz, 96 dB μ	52.000 MHz	-1.5 dB (± 0.5 dB)

- ❑ Press and hold in the [MENU] button for 2 seconds to save the new setting and exit from the alignment mode.

S-meter Adjustment

- ❑ Set the following controls as indicated:
 - [ANT 1/2] button: ANT 1
 - [IPO] button: AMP1
 - [ATT] button: OFF
 - [R.FLT] button: 6 kHz
 - [AGC] button: AUTO
 - [RF GAIN] knob: Fully clockwise
 - [VRF] button: THRU
- ❑ Connect the RF Signal Generator to the “ANT 1” jack, then set the frequency to 14.200 MHz.
- ❑ Set the Main Band (VFO-A) frequency to 14.200 MHz in the CW mode.
- ❑ Press and hold in the [1(1.8)], [2(3.5)], and [3(7)] keys, while turning the radio on, to enter the alignment mode.
- ❑ Select the appropriate “Alignment Parameter” using the Main Tuning Dial knob per the chart below, then set the RF Signal Generator output to each level, and adjust the [SUB(VFO-B)] knob for the corresponding Main S-meter deflection, then press the [ENT] key to save the new setting at each frequency.

ALIGNMENT PARAMETER	RF SIGNAL GENERATOR	MAIN S-METER
B21 S-1	12 dB μ	S-1
B22 S-5	24 dB μ	S-5
B23 S-7	30 dB μ	S-7
B24 S-9	36 dB μ	S-9
B25 S10	46 dB μ	S-9+10dB
B26 S20	56 dB μ	S-9+20dB
B27 S30	66 dB μ	S-9+30dB
B28 S40	76 dB μ	S-9+40dB
B29 S50	86 dB μ	S-9+50dB
B30 S60	96 dB μ	S-9+60dB

- ❑ Press and hold in the [MENU] button for 2 seconds to save the new setting and exit from the alignment mode.

Alignment

FM Gain Adjustment

- ❑ Set the following controls as indicated:
 - [ANT 1/2] button: ANT 1
 - [IPO] button: AMP1
 - [ATT] button: OFF
 - [R.FLT] button: 15 kHz
 - [AGC] button: AUTO
 - [RF GAIN] knob: Fully clockwise
 - [VRF] button: THRU
- ❑ Set the RF Signal Generator to 12 dB μ at the 28.8500 MHz with ± 3.5 kHz deviation FM modulation of a 1 kHz audio signal.
- ❑ Set the Main Band (VFO-A) frequency to 28.850 MHz in the FM-W mode.
- ❑ Press and hold in the [1(1.8)], [2(3.5)], and [3(7)] keys, while turning the radio on, to enter the alignment mode.
- ❑ Rotate the Main Tuning Dial knob to select the alignment parameter "b32 FnG."
- ❑ Rotate the [SUB(VFO-B)] knob so that the Main S-meter reading is "S-3."
- ❑ Press and hold in the [MENU] button for 2 seconds to save the new setting and exit from the alignment mode.
- ❑ Set the RF Signal Generator to 12 dB μ at the 52.000 MHz with ± 3.5 kHz deviation FM modulation of a 1 kHz audio signal.
- ❑ Set the Main Band (VFO-A) frequency to 52.000 MHz in the FM-W mode.
- ❑ Press and hold in the [1(1.8)], [2(3.5)], and [3(7)] keys, while turning the radio on, to enter the alignment mode again.
- ❑ Rotate the Main Tuning Dial knob to select the alignment parameter "b33 FnG."
- ❑ Rotate the [SUB(VFO-B)] knob so that the Main S-meter reading is "S-3."
- ❑ Press and hold in the [MENU] button for 2 seconds to save the new setting and exit from the alignment mode.

DVS Unit Adjustment

- ❑ Connect the Ohmmeter lead between TP2905 and ground on the DVS Unit.
- ❑ Adjust VR2901 on the DVS Unit for 40 k-Ohms (± 200 Ohms) on the Ohmmeter.

Sub Receiver Adjustment

2nd/3rd Local Level Adjustment

- ❑ Set the following controls as indicated:
 - [ANT 1/2] button: ANT 1
 - [IPO] button: AMP1
 - [ATT] button: OFF
 - [AGC] button: AUTO
 - [RF GAIN] knob: Fully clockwise
 - [SUB RX] button: ON
- ❑ Connect the RF millivoltmeter to TP4501 on the RX-2 Unit.
- ❑ Adjust T4521 and T4501 on the RX-2 Unit for maximum deflection on the RF millivoltmeter (more than + 8 dBm).
- ❑ Connect the RF millivoltmeter to TP4502 on the RX-2 Unit.
- ❑ Adjust T4504 on the RX-2 Unit for maximum deflection on the RF millivoltmeter (more than + 6 dBm).

IF Transformer Adjustment

- ❑ Set the following controls as indicated:
 - [ANT 1/2] button: ANT 1
 - [IPO] button: AMP1
 - [ATT] button: OFF
 - [AGC] button: AUTO
 - [RF GAIN] knob: Fully clockwise
 - [SUB RX] button: ON
- ❑ Set the Sub Band (VFO-B) frequency to 14.200 MHz in the CW mode.
- ❑ Connect the AC millivoltmeter and 4 Ohm dummy load to the EXT SP jack.
- ❑ Connect the RF Signal Generator to the "ANT 1" jack, then set the output level to 0 dB μ at the 14.200 MHz.

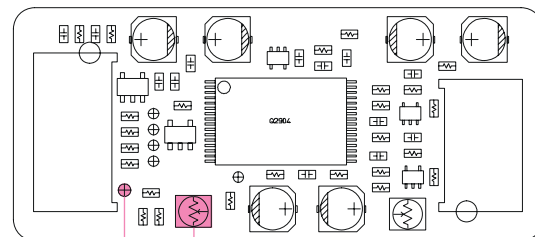

VR2901
TP2905

DVS UNIT ALIGNMENT POINTS

- ❑ Adjust T4507, T4509, T4511, T4515, T4517, T4518, T4519, T4516, T4513 and T4510 on the RX-2 Unit in succession several times for maximum deflection on the AF millivoltmeter.

If the Sub S-meter deflects while adjusting, reduce the RF Signal Generator output so that the Sub S-meter does not deflect.

MCF Adjustment

- ❑ Set the following controls as indicated:
[ANT 1/2] button: ANT 1
[IPO] button: AMP2
[ATT] button: OFF
[AGC] button: AUTO
[RF GAIN] knob: Fully clockwise
[SUB RX] button: ON
- ❑ Set the Sub Band (VFO-B) frequency to 52.000 MHz in the FM-W mode.
- ❑ Connect the SINAD meter and 4 Ohm dummy load to the EXT SP jack.
- ❑ Connect the RF Signal Generator to the "ANT 1" jack, then set the output level to 0 dB μ at the 52.000 MHz with ± 3.5 kHz deviation FM modulation of a 1 kHz audio signal.
- ❑ Adjust T4507 and T4509 on the RX-2 Unit in succession several times for maximum deflection on the SINAD meter.

If the Sub S-meter deflects while adjusting, reduce the RF Signal Generator output so that the Sub S-meter does not deflect.

IF Trap Adjustment

- ❑ Set the following controls as indicated:
[ANT 1/2] button: ANT 1
[IPO] button: AMP1
[ATT] button: OFF
[AGC] button: AUTO
[RF GAIN] knob: Fully clockwise
[SUB RX] button: ON
 - ❑ Set the Sub Band (VFO-B) frequency to 50.000 MHz in the CW mode.
 - ❑ Connect the AC millivoltmeter and 4 Ohm dummy load to the EXT SP jack.
 - ❑ Connect the RF Signal Generator to the "ANT 1" jack, then set the output level to 60 dB μ at the 40.455 MHz.
 - ❑ Adjust T4520 on the RX-2 Unit for minimum deflection on the AC millivoltmeter.
- If the Sub S-meter deflects while adjusting, reduce the RF Signal Generator output so that the Sub S-meter does not deflect.

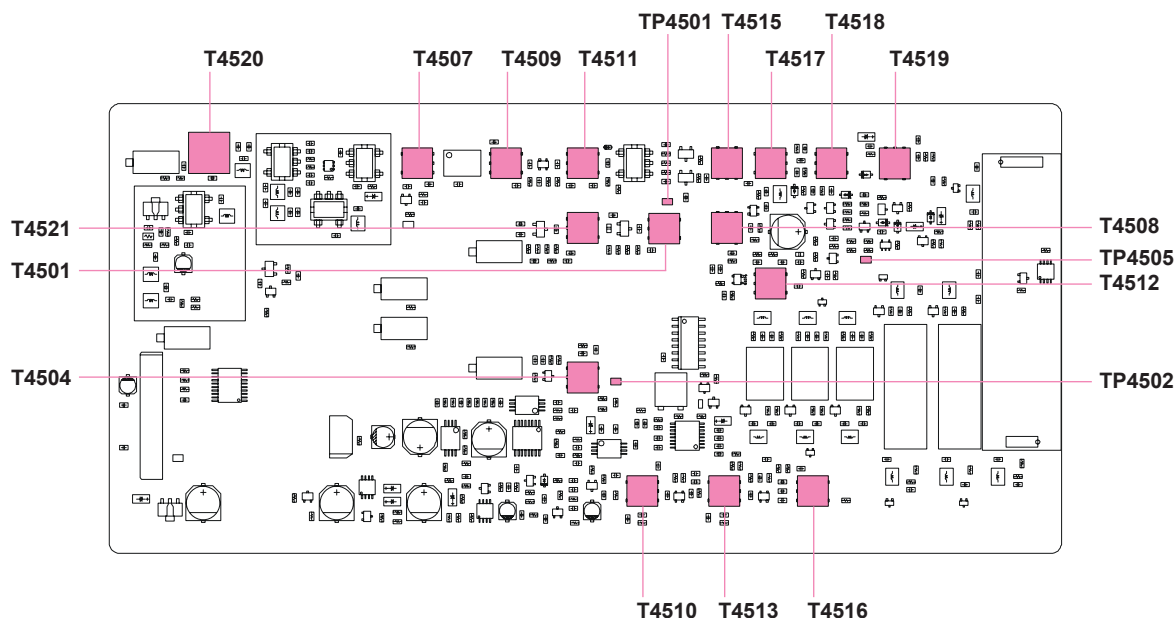

RX-2 UNIT ALIGNMENT POINTS

Alignment

Noise Blanker Circuit Adjustment

- ❑ Set the following controls as indicated:
 - [ANT 1/2] button: ANT 1
 - [IPO] button: AMP1
 - [ATT] button: OFF
 - [AGC] button: "Sub band (VFO-B)" AUTO
 - [NB] button: "Sub band (VFO-B)" ON
 - (for short-duration pulse noise)
 - [NB] knob: Fully clockwise
 - [RF GAIN] knob: Fully clockwise
 - [SUB RX] button: ON
- ❑ Set the Sub Band (VFO-B) frequency to 14.200 MHz in the CW mode.
- ❑ Connect the DC voltmeter to TP4505 on the RX-2 Unit.
- ❑ Connect the RF Signal Generator to the "ANT 1" jack, then set the output level to 30 dB μ at the 14.200 MHz.
- ❑ Adjust T4508 and T4512 on the RX-2 Unit for minimum deflection on the DC voltmeter.
- ❑ Turn the Sub band's (VFO-B) NB to "OFF" by pressing the [B] button followed by the [NB] button.

IF Gain Adjustment

- ❑ Set the following controls as indicated:
 - [ANT 1/2] button: ANT 1
 - [IPO] button: AMP1
 - [ATT] button: OFF
 - [AGC] button: "Sub band (VFO-B)" AUTO
 - [PITCH] knob: 700 Hz
 - [RF GAIN] knob: Fully clockwise
 - [SUB RX] button: ON
- ❑ Connect the AC millivoltmeter and 4 Ohm dummy load to the EXT SP jack.
- ❑ Connect the RF Signal Generator to the "ANT 1" jack, then set the output level to 36 dB μ at the 1.900 MHz.
- ❑ Set the Sub Band (VFO-B) frequency to 1.900 MHz in the CW mode.
- ❑ Press and hold in the [1(1.8)], [2(3.5)], and [3(7)] keys, while turning the radio on, to enter the alignment mode.
- ❑ Adjust the Sub [AF GAIN] knob so that the AC millivoltmeter reading is "0 dB."

- ❑ Select the appropriate "Alignment Parameter" using the Main Tuning Dial knob per the chart below, then set the RF Signal Generator output to each listed level, and adjust the [SUB(VFO-B)] knob for the corresponding AC millivoltmeter reading at each frequency.

ALIGNMENT PARAMETER	RF SIGNAL GENERATOR	VFO-B FREQUENCY	AC MILLIVOLTMETER
C01 iGn	1.900 MHz, 9 dB μ	1.900 MHz	-1.5 dB (± 0.5 dB)
C02 iGn	3.750 MHz, 9 dB μ	3.750 MHz	-1.5 dB (± 0.5 dB)
C03 iGn	7.150 MHz, 9 dB μ	7.150 MHz	-1.5 dB (± 0.5 dB)
C04 iGn	10.125 MHz, 9 dB μ	10.125 MHz	-1.5 dB (± 0.5 dB)
C05 iGn	14.175 MHz, 9 dB μ	14.175 MHz	-1.5 dB (± 0.5 dB)
C06 iGn	18.117 MHz, 9 dB μ	18.117 MHz	-1.5 dB (± 0.5 dB)
C07 iGn	21.255 MHz, 9 dB μ	21.255 MHz	-1.5 dB (± 0.5 dB)
C08 iGn	24.940 MHz, 9 dB μ	24.940 MHz	-1.5 dB (± 0.5 dB)
C09 iGn	28.850 MHz, 9 dB μ	28.850 MHz	-1.5 dB (± 0.5 dB)
C10 iGn	52.000 MHz, 9 dB μ	52.000 MHz	-1.5 dB (± 0.5 dB)

- ❑ Press and hold in the [MENU] button for 2 seconds to save the new setting and exit from the alignment mode.

S-meter Adjustment

- ❑ Set the following controls as indicated:
 - [ANT 1/2] button: ANT 1
 - [IPO] button: AMP1
 - [ATT] button: OFF
 - [AGC] button: "Sub band (VFO-B)" AUTO
 - [RF GAIN] knob: Fully clockwise
 - [SUB RX] button: ON
- ❑ Connect the RF Signal Generator to the "ANT 1" jack, then set the frequency to 14.200 MHz.
- ❑ Set the Sub Band (VFO-B) frequency to 14.200 MHz in the CW mode.
- ❑ Press and hold in the [1(1.8)], [2(3.5)], and [3(7)] keys, while turning the radio on, to enter the alignment mode.
- ❑ Select the appropriate "Alignment Parameter" using the Main Tuning Dial knob per the chart below, then set the RF Signal Generator output to each listed level, and adjust the [SUB(VFO-B)] knob until the corresponding Sub S-meter indicator just lights (i.e. Adjust to the lowest value of each "S" unit range), then press the [ENT] key to save the new setting at each frequency.

ALIGNMENT PARAMETER	RF SIGNAL GENERATOR	SUB S-METER
C11 S-0	9 dB μ	One dot
C12 S-1	12 dB μ	S-1
C13 S-5	24 dB μ	S-5
C14 S-7	30 dB μ	S-7
C15 S-9	36 dB μ	S-9
C16 S10	46 dB μ	S-9+10dB
C17 S20	56 dB μ	S-9+20dB
C18 S30	66 dB μ	S-9+30dB
C19 S40	76 dB μ	S-9+40dB
C20 S50	86 dB μ	S-9+50dB
C21 S60	96 dB μ	S-9+60dB

- ❑ Press and hold in the [MENU] button for 2 seconds to save the new setting and exit from the alignment mode.

RX Carrier Point Adjustment

- ❑ Set the following controls as indicated:
 - [ANT 1/2] button: ANT 1
 - [IPO] button: AMP1
 - [ATT] button: OFF
 - [AGC] button: "Sub band (VFO-B)" AUTO
 - [RF GAIN] knob: Fully clockwise
 - [SUB RX] button: ON
- ❑ Connect the RF Signal Generator to the "ANT 1" jack, then set the frequency to 14.200 MHz.
- ❑ Connect the AC millivoltmeter, Frequency Counter, and 4 Ohm dummy load to the EXT SP jack.
- ❑ Set the Sub Band (VFO-B) frequency to 14.200 MHz in the CW mode.
- ❑ Press and hold in the [1(1.8)], [2(3.5)], and [3(7)] keys, while turning the radio on, to enter the alignment mode.
- ❑ Rotate the Main Tuning Dial knob to select the alignment parameter "C22 L-C."
- ❑ Set the RF Generator frequency so that the Frequency counter reading is "1 kHz," then adjust the Sub [AF GAIN] knob so that the AC millivoltmeter reading is "0 dB."
- ❑ Set the RF Generator frequency so that the Frequency counter reading is "300 Hz."
- ❑ Rotate the [SUB(VFO-B)] knob so that the AC millivoltmeter reading is "-6 dB (± 0.2 dB)."
- ❑ Set the RF Generator frequency so that the Frequency counter reading is "2.6 kHz."
- ❑ Confirm that the AC millivoltmeter reading is better than "-6 dB."

- ❑ Rotate the Main Tuning Dial knob to select the alignment parameter "C23 U-C."
- ❑ Set the RF Generator frequency so that the Frequency counter reading is "1 kHz," then adjust the Sub [AF GAIN] knob so that the AC millivoltmeter reading is "0 dB."
- ❑ Set the RF Generator frequency so that the Frequency counter reading is "300 Hz."
- ❑ Rotate the [SUB(VFO-B)] knob so that the AC millivoltmeter reading is "-6 dB (± 0.2 dB)."
- ❑ Set the RF Generator frequency so that the Frequency counter reading is "2.6 kHz."
- ❑ Confirm that the AC millivoltmeter reading is better than "-6 dB."
- ❑ Rotate the Main Tuning Dial knob to select the alignment parameter "C24 LnC."
- ❑ Set the RF Generator frequency so that the Frequency counter reading is "1 kHz," then adjust the Sub [AF GAIN] knob so that the AC millivoltmeter reading is "0 dB."
- ❑ Set the RF Generator frequency so that the Frequency counter reading is "600 Hz."
- ❑ Rotate the [SUB(VFO-B)] knob so that the AC millivoltmeter reading is "-6 dB (± 0.2 dB)."
- ❑ Rotate the Main Tuning Dial knob to select the alignment parameter "C25 UnC."
- ❑ Set the RF Generator frequency so that the Frequency counter reading is "1 kHz," then adjust the Sub [AF GAIN] knob so that the AC millivoltmeter reading is "0 dB."
- ❑ Set the RF Generator frequency so that the Frequency counter reading is "600 Hz."
- ❑ Rotate the [SUB(VFO-B)] knob so that the AC millivoltmeter reading is "-6 dB (± 0.2 dB)."
- ❑ Press and hold in the [MENU] button for 2 seconds to save the new setting and exit from the alignment mode.

Alignment

Transmitter Adjustment

TX IFT Adjustment

- Disconnect the coaxial cable from J1004 on the MAIN Unit, then connect the RF millivoltmeter to J1004.
- Set the Main Band (VFO-A) frequency to 14.200 MHz in the FM mode, then rotate the [RF PWR] knob to the fully clockwise position.
- Press the PTT button, adjust T1033, T1029, T1020, T1014, T1010, and T1007 for maximum deflection on the RF millivoltmeter.
- Release the PTT button.
- Disconnect the RF millivoltmeter from J1004, then re-connect the coaxial cable to J1004.

TX MCF Adjustment

- Disconnect the coaxial cables from J1004, J1038, and J1039 on the MAIN Unit.
- Set the Main Band (VFO-A) frequency to 28.850 MHz in the USB mode, then rotate the [RF PWR] knob to the fully clockwise position.
- Connect the Tracking Generator to J1039 and connect the Spectrum Analyzer to J1020.
- Set up the Spectrum Analyzer as shown below:
Center Frequency: 69.450 MHz
Span: 50 kHz
- Press the PTT button. Adjust T1020 on the MAIN Unit to obtain maximum amplitude with minimum ripple.
- Disconnect the Tracking Generator from J1039 and the Spectrum Analyzer from J1020.
- Connect the coaxial cables back to J1004, J1038, and J1039.

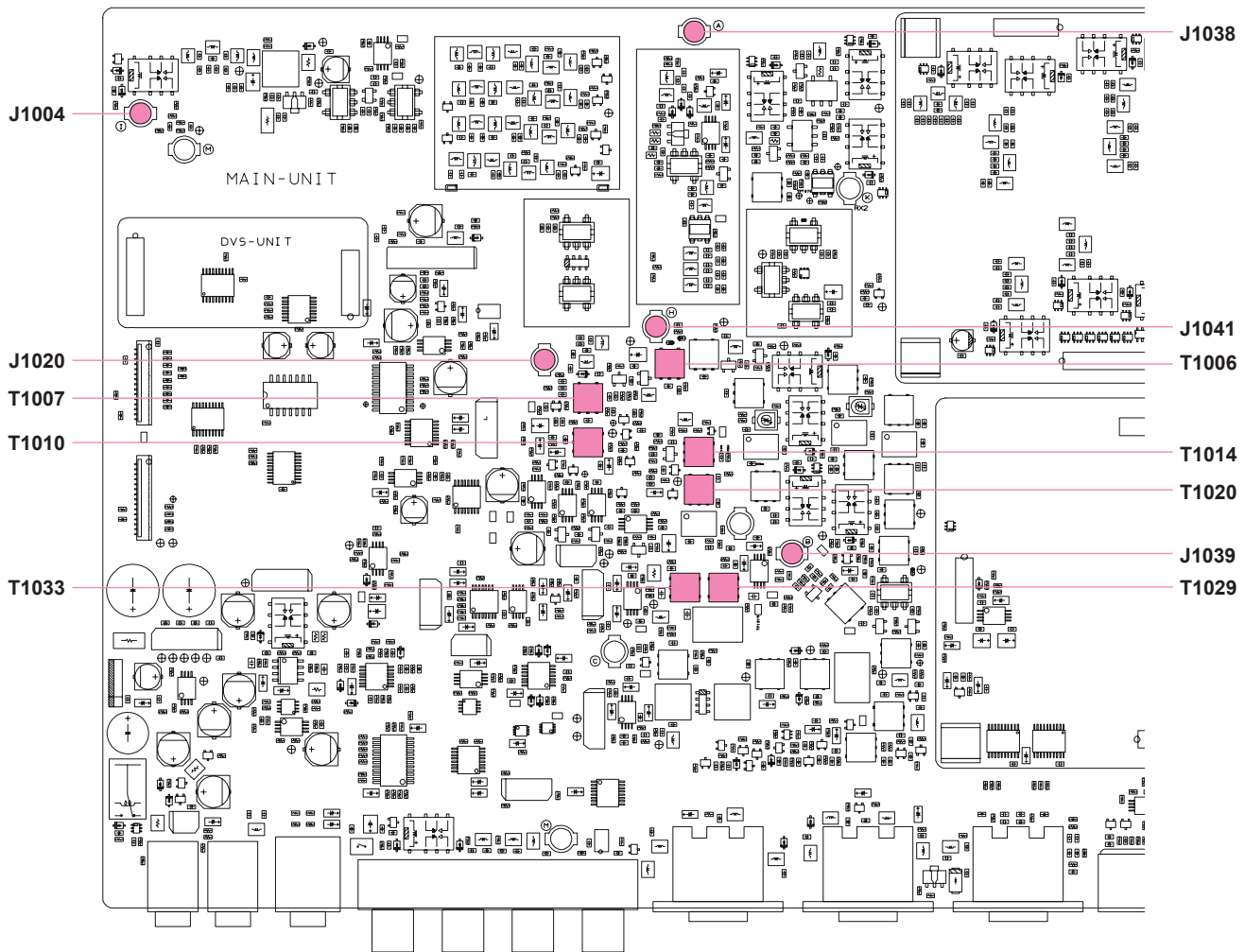

MAIN UNIT (TRANSMITTER SECTION) ALIGNMENT POINTS

TX Scope Circuit Adjustment

- ❑ Disconnect the coaxial cable from J1041 on the MAIN Unit, then connect the RF millivoltmeter to J1041.
- ❑ Disconnect the coaxial cable from J1004 on the MAIN Unit.
- ❑ Set the Main Band (VFO-A) frequency to 14.200 MHz in the CW mode, then rotate the [RF PWR] knob to the fully clockwise position.
- ❑ Press the PTT button, then adjust T1006 for maximum deflection on the RF millivoltmeter.
- ❑ Release the PTT button.
- ❑ Disconnect the RF millivoltmeter from J1041, then re-connect the coaxial cable to J1041.
- ❑ Re-connect the coaxial cable to J1004.

PA-A Unit Adjustment

Preparation

- ❑ Disconnect the coaxial cables from J5001 and J5006 on the PA-A Unit, then terminate J5001 and J5006 into a 50-Ohm resistors.
- ❑ Disconnect the jumper plugs from J5003 and J5004 on the PA-A Unit, and remove the jumper wire that is connected between TP5031 and T5032 on the PA-A Unit.

Pre-Drive Stage Idling Current Adjustment

- ❑ Connect the DC ammeter to J5003 on the PA-A Unit.
- ❑ Press and hold in the [1(1.8)], [2(3.5)], and [3(7)] keys, while turning the radio on, to enter the alignment mode.

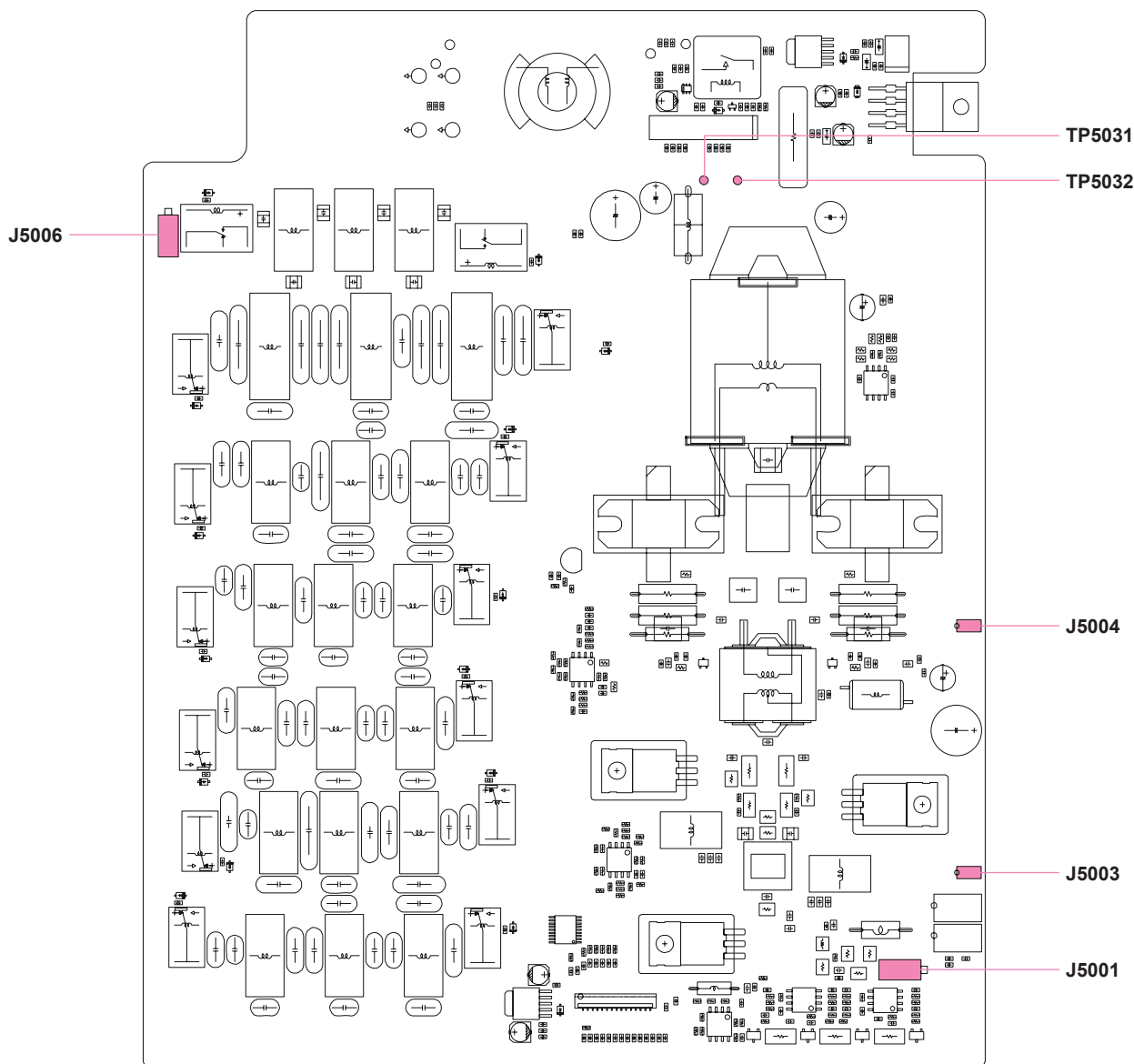

PA-A UNIT ALIGNMENT POINTS

Alignment

- ❑ Rotate the Main Tuning Dial knob to select the alignment parameter “d01 Pdb.”
- ❑ Press the PTT button, then adjust the [SUB(VFO-B)] knob so that the DC ammeter reading is “100 mA (± 5 mA).”
- ❑ Release the PTT button.

Drive Stage Idling Current Adjustment

- ❑ Release the PTT button.
- ❑ Connect the DC ammeter to J5004 on the PA-A Unit.
- ❑ Rotate the Main Tuning Dial knob to select the alignment parameter “d02 db1.”
- ❑ Press the PTT button, then adjust the [SUB(VFO-B)] knob so that the DC ammeter reading is “500 mA (± 50 mA).”
- ❑ Release the PTT button.
- ❑ Rotate the Main Tuning Dial knob to select the alignment parameter “d03 db2.”
- ❑ Press the PTT button, then adjust the [SUB(VFO-B)] knob so that the DC ammeter reading is “500 mA (± 50 mA).”
- ❑ Release the PTT button.

Final Stage Idling Current Adjustment

- ❑ Connect the DC ammeter between TP5031 and TP5032 on the PA-A Unit.
- ❑ Rotate the Main Tuning Dial knob to select the alignment parameter “d04 Fb1.”
- ❑ Press the PTT button, then adjust the [SUB(VFO-B)] knob so that the DC ammeter reading is “1 A (± 50 mA).”
- ❑ Release the PTT button.
- ❑ Rotate the Main Tuning Dial knob to select the alignment parameter “d05 Fb2.”
- ❑ Press the PTT button, then adjust the [SUB(VFO-B)] knob so that the DC ammeter reading is “1 A (± 50 mA).”
- ❑ Release the PTT button.

Termination

- ❑ Press and hold in the [MENU] button for 2 seconds to save the new setting and exit from the alignment mode.
- ❑ Disconnect the 50-Ohm resistors from J5001 and J5006, then connect the coaxial cables to J5001 and J5006.
- ❑ Re-connect the jumper plugs to J5003 and J5004, and re-connect the jumper wire between TP5031 and TP5032.

Antenna Tuner Adjustment

CM Coupler Balance Adjustment

- ❑ Disconnect the coaxial cable from J6010 on the TUNER-MAIN Unit, then connect the 50-Ohm Dummy Load to J6010.
- ❑ Connect the Digital DC voltmeter (high-Z) to pin 3 of J6009 on the TUNER-MAIN Unit.
- ❑ Turn off the [TUNE] switch, then set the Main band (VFO-A) frequency to 24.900 MHz in the FM mode.
- ❑ Press the PTT switch, then rotate the [RF PWR] knob for 50 Watts on the Wattmeter.
- ❑ Adjust TC6002 on the TUNER-MAIN Unit for minimum deflection on the DC voltmeter (less than 0.1 V).
- ❑ Release the PTT switch, then disconnect the 50-Ohm Dummy Load from J6010 and re-connect the coaxial cable to J6010.

ϕ , Z-Null Adjustment

- ❑ Connect the 50-Ohm Dummy Load and Wattmeter to the "ANT 1" jack.
- ❑ Turn off the [TUNE] switch, then set the Main Band (VFO-A) frequency to 24.900 MHz in the FM mode.
- ❑ Press the PTT switch, then rotate the [RF PWR] knob for 50 Watts on the Wattmeter.
- ❑ Release the PTT switch, then disconnect the coaxial cable from J6001 on the TUNER-MAIN Unit, and re-connect the 50-Ohm Dummy Load to J6001.
- ❑ Connect the Digital DC voltmeter (high-Z) between TP6001 and TP6002 on the TUNER-MAIN Unit, then turn on the [TUNE] switch.
- ❑ Press the PTT switch, then adjust TC6001 on the TUNER-MAIN Unit for 0 V (± 0.08 V) on the DC voltmeter.
- ❑ Release the PTT switch, then disconnect the 50-Ohm Dummy Load from J6001 and re-connect the coaxial cable to J6001.

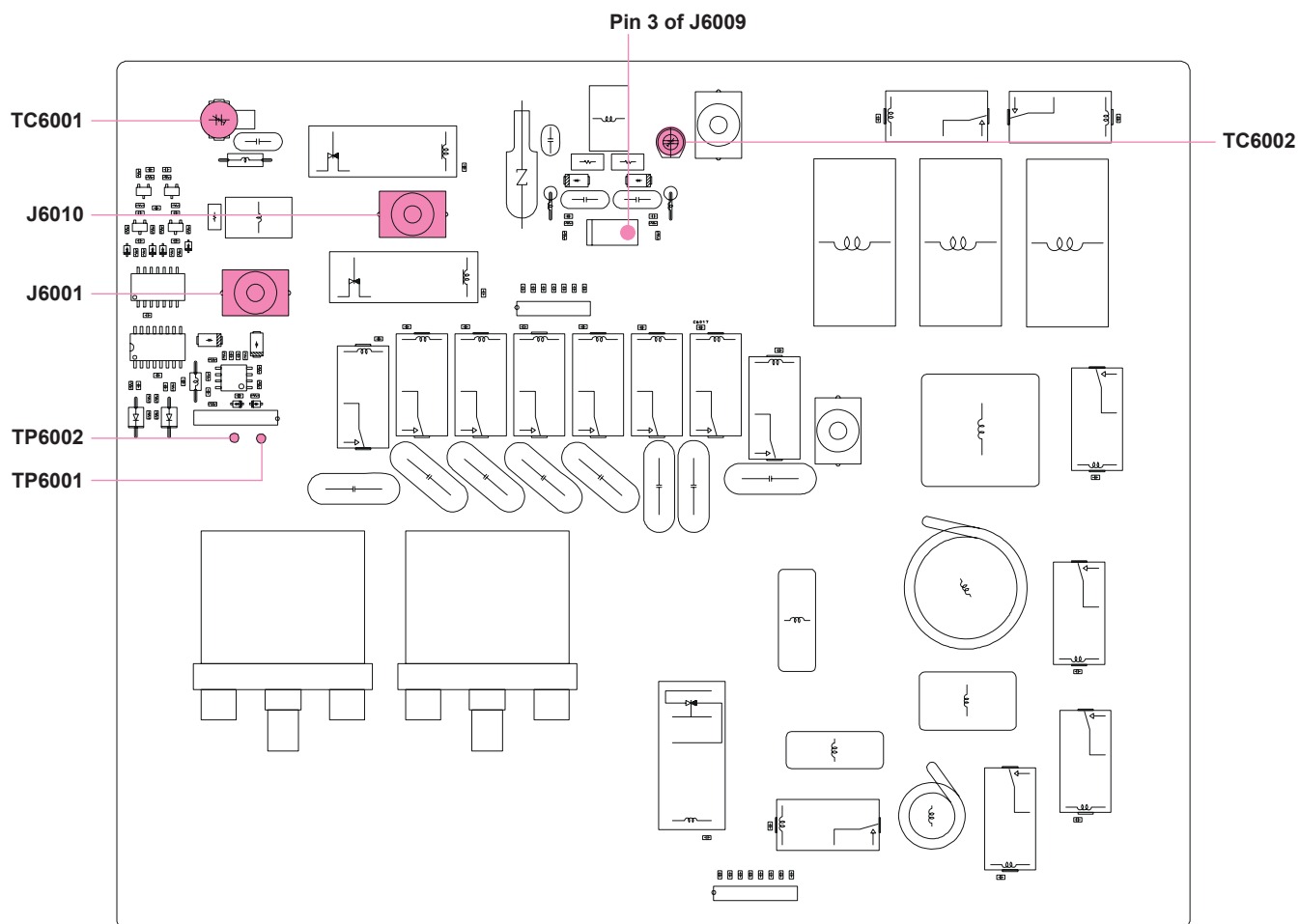

TUNER-MAIN UNIT ALIGNMENT POINTS

Alignment

Transmitter Section Alignment Mode

Preparation

- ❑ Referring to table below, tune the Main Band (VFO-A) to each frequency listed.

BAND	VFO-A FREQUENCY	MODE
1.8 MHz Band	1.820 MHz	USB
3.5 MHz Band	3.570 MHz	USB
7 MHz Band	7.050 MHz	USB
10 MHz Band	10.100 MHz	USB
14 MHz Band	14.200 MHz	USB
18 MHz Band	18.100 MHz	USB
21 MHz Band	21.200 MHz	USB
24.5 MHz Band	24.900 MHz	USB
28 MHz Band	29.690 MHz	USB
50 MHz Band	53.900 MHz*	USB

* UK: 51.900 MHz, EU: 50.390 MHz, FRA: 51.190 MHz

- ❑ Connect the 50-Ohm Dummy Load and Wattmeter to the “ANT 1” jack.
- ❑ Connect the Audio Generator to pin 8 of the MIC jack (pin 7: GND), then set the output level to 0.5 mV @1 kHz.

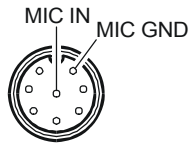

ALC Adjustment

- ❑ Press and hold in the [1(1.8)], [2(3.5)], and [3(7)] keys, while turning the radio on, to enter the alignment mode.
- ❑ Rotate the Main Tuning Dial knob to select the alignment parameter “d08 iAL” for the 1.8 MHz amateur band’s ALC Adjustment, then rotate the [SUB(VFO-B)] knob so that the VFO-B frequency display shows “0020.”
- ❑ Rotate the [MIC] knob to the fully counter-clockwise position.
- ❑ Press the PTT switch, then gently rotate the [MIC] knob to the fully clockwise position.
- ❑ Rotate the [SUB(VFO-B)] knob for 115 W (+5W/–0W) on the Wattmeter.
- ❑ Release the PTT switch.
- ❑ Rotate the Main Tuning Dial knob to select the alignment parameter “d09 iAL” for the 3.5 MHz amateur band’s ALC Adjustment, then rotate the [SUB(VFO-B)] knob so that the VFO-B frequency display shows “0020.”
- ❑ Rotate the [MIC] knob to the fully counter-clockwise position.
- ❑ Press the PTT switch, then gently rotate the [MIC] knob to the fully clockwise position.
- ❑ Rotate the [SUB(VFO-B)] knob for 115 W (+5W/–0W) on the Wattmeter.
- ❑ Release the PTT switch.
- ❑ Rotate the Main Tuning Dial knob to select the alignment parameter “d10 iAL” for the 7 MHz amateur band’s ALC Adjustment, then rotate the

[SUB(VFO-B)] knob so that the VFO-B frequency display shows “0020.”

- ❑ Rotate the [MIC] knob to the fully counter-clockwise position.
- ❑ Press the PTT switch, then gently rotate the [MIC] knob to the fully clockwise position.
- ❑ Rotate the [SUB(VFO-B)] knob for 115 W (+5W/–0W) on the Wattmeter.
- ❑ Release the PTT switch.
- ❑ Rotate the Main Tuning Dial knob to select the alignment parameter “d11 iAL” for the 10 MHz amateur band’s ALC Adjustment, then rotate the [SUB(VFO-B)] knob so that the VFO-B frequency display shows “0020.”
- ❑ Rotate the [MIC] knob to the fully counter-clockwise position.
- ❑ Press the PTT switch, then gently rotate the [MIC] knob to the fully clockwise position.
- ❑ Rotate the [SUB(VFO-B)] knob for 115 W (+5W/–0W) on the Wattmeter.
- ❑ Release the PTT switch.
- ❑ Rotate the Main Tuning Dial knob to select the alignment parameter “d12 iAL” for the 14 MHz amateur band’s ALC Adjustment, then rotate the [SUB(VFO-B)] knob so that the VFO-B frequency display shows “0020.”
- ❑ Rotate the [MIC] knob to the fully counter-clockwise position.
- ❑ Press the PTT switch, then gently rotate the [MIC] knob to the fully clockwise position.
- ❑ Rotate the [SUB(VFO-B)] knob for 115 W (+5W/–0W) on the Wattmeter.
- ❑ Release the PTT switch.
- ❑ Rotate the Main Tuning Dial knob to select the alignment parameter “d13 iAL” for the 18 MHz amateur band’s ALC Adjustment, then rotate the [SUB(VFO-B)] knob so that the VFO-B frequency display shows “0020.”
- ❑ Rotate the [MIC] knob to the fully counter-clockwise position.
- ❑ Press the PTT switch, then gently rotate the [MIC] knob to the fully clockwise position.
- ❑ Rotate the [SUB(VFO-B)] knob for 115 W (+5W/–0W) on the Wattmeter.
- ❑ Release the PTT switch.
- ❑ Rotate the Main Tuning Dial knob to select the alignment parameter “d14 iAL” for the 21 MHz amateur band’s ALC Adjustment, then rotate the [SUB(VFO-B)] knob so that the VFO-B frequency display shows “0020.”

Alignment

- ❑ Rotate the [MIC] knob to the fully counter-clockwise position.
- ❑ Press the PTT switch, then gently rotate the [MIC] knob to the fully clockwise position.
- ❑ Rotate the [SUB(VFO-B)] knob for 115 W (+5W/-0W) on the Wattmeter.
- ❑ Release the PTT switch.
- ❑ Rotate the Main Tuning Dial knob to select the alignment parameter “d15 iAL” for the 24 MHz amateur band’s ALC Adjustment, then rotate the [SUB(VFO-B)] knob so that the VFO-B frequency display shows “0020.”
- ❑ Rotate the [MIC] knob to the fully counter-clockwise position.
- ❑ Press the PTT switch, then gently rotate the [MIC] knob to the fully clockwise position.
- ❑ Rotate the [SUB(VFO-B)] knob for 100 W (+5W/-0W) on the Wattmeter, then rotate the [SUB(VFO-B)] knob so that the VFO-B frequency indication “10” increase.
- ❑ Release the PTT switch.
- ❑ Rotate the Main Tuning Dial knob to select the alignment parameter “d16 iAL” for the 28 MHz amateur band’s ALC Adjustment, then rotate the [SUB(VFO-B)] knob so that the VFO-B frequency display shows “0020.”
- ❑ Rotate the [MIC] knob to the fully counter-clockwise position.
- ❑ Press the PTT switch, then gently rotate the [MIC] knob to the fully clockwise position.
- ❑ Rotate the [SUB(VFO-B)] knob for 100 W (+5W/-0W) on the Wattmeter, then rotate the [SUB(VFO-B)] knob so that the VFO-B frequency indication “10” increase.
- ❑ Release the PTT switch.
- ❑ Rotate the Main Tuning Dial knob to select the alignment parameter “d17 iAL” for the 50 MHz amateur band’s ALC Adjustment, then rotate the [SUB(VFO-B)] knob so that the VFO-B frequency display shows “0020.”
- ❑ Rotate the [MIC] knob to the fully counter-clockwise position.
- ❑ Press the PTT switch, then gently rotate the [MIC] knob to the fully clockwise position.
- ❑ Rotate the [SUB(VFO-B)] knob for 100 W (+5W/-0W) on the Wattmeter, then rotate the [SUB(VFO-B)] knob so that the VFO-B frequency indication “10” increase.
- ❑ Release the PTT switch.

- ❑ Press and hold in the [MENU] button for 2 seconds to save the new setting and exit from the alignment mode.

Power Adjustment

- ❑ Connect the 50-Ohm Dummy Load and Wattmeter to the “ANT 1” jack.
- ❑ Rotate the [RF PWR] knob to fully clockwise.
- ❑ Set the Main Band (VFO-A) frequency to 14.200 MHz in the CW mode.
- ❑ Press and hold in the [1(1.8)], [2(3.5)], and [3(7)] keys, while turning the radio on, to enter the alignment mode.
- ❑ Rotate the Main Tuning Dial knob to select the alignment parameter “d22AP2h.”
- ❑ Rotate the [SUB(VFO-B)] knob so that the VFO-B frequency display shows “0.”
- ❑ Press the PTT switch, then rotate the [SUB(VFO-B)] knob for 100 W (+5 W/-0 W) on the Wattmeter, and confirm the the Sub S-meter is deflect.
- ❑ Release the PTT switch.
- ❑ Press and hold in the [MENU] button for 2 seconds to save the new setting and exit from the alignment mode.

ALC Meter Adjustment

- ❑ Connect the 50-Ohm Dummy Load and Wattmeter to the “ANT 1” jack.
- ❑ Connect the Audio Generator to pin 8 of the MIC jack (pin 7: GND), then set the output level to +0 mV @1 kHz.
- ❑ Set the Main Band (VFO-A) frequency to 14.200 MHz in the USB mode.
- ❑ Rotate the [MIC] knob to the 12 o’clock position, and rotate the [RF PWR] knob to the fully clockwise position.
- ❑ Press and hold in the [1(1.8)], [2(3.5)], and [3(7)] keys, while turning the radio on, to enter the alignment mode.
- ❑ Rotate the Main Tuning Dial knob to select the alignment parameter “d50 ALC.”
- ❑ Press the PTT switch, then adjust the Audio Generator output level to the position where the ALC meter just starts to deflect.
- ❑ Release the PTT switch, then increase the Audio Generator output level for “9 dB.”
- ❑ Press the [ENT] key, *while pressing and holding in the PTT switch*, then rotate the [SUB(VFO-B)] knob for maximum deflection on the ALC meter zone (S9+10dB).



Alignment

- Release the PTT switch, then press and hold in the [MENU] button for 2 seconds to save the new setting and exit from the alignment mode.

TX Output Power/PO Meter/TXG Adjustment

- Referring to table below, tune the transceiver to each frequency listed.

BAND	VFO-A FREQUENCY	MODE
1.8 MHz Band	1.820 MHz	CW
3.5 MHz Band	3.570 MHz	CW
7 MHz Band	7.050 MHz	CW
10 MHz Band	10.100 MHz	CW
14 MHz Band	14.200 MHz	CW
18 MHz Band	18.100 MHz	CW
21 MHz Band	21.200 MHz	CW
24.5 MHz Band	24.900 MHz	CW
28 MHz Band	28.700 MHz	CW
50 MHz Band	52.000 MHz*	CW

* UK: 51.000 MHz, EU: 50.250 MHz, FRA: 50.700 MHz

- Connect the 50-Ohm Dummy Load and Wattmeter to the "ANT 1" jack.
- Set the Main Band (VFO-A) frequency to 1.820 MHz in the CW mode.
- Press and hold in the [1(1.8)], [2(3.5)], and [3(7)] keys, while turning the radio on, to enter the alignment mode.
- Rotate the Main Dial knob to select the alignment parameter "d18AP2h."
- Rotate the [SUB(VFO-B)] knob so that the VFO-B frequency display shows "0."
- Rotate the [VRF] knob for 100 W on the PO meter.
- Press the PTT switch, then rotate the [SUB(VFO-B)] knob for 100 W on the Wattmeter.
- Rotate the [CLAR] knob so that the Sub S-meter deflects to "S-9."
- Release the PTT switch.
- Perform the same procedures for the Alignment Menus "d18bP1h" through "d27EP10," per the chart at the right.

AM-TXG Adjustment

- Connect the 50-Ohm Dummy Load and Wattmeter to the "ANT 1" jack.
- Rotate the [RF PWR] knob to fully clockwise.
- Set the Main Band (VFO-A) frequency to 14.200 MHz in the AM mode.
- Press and hold in the [1(1.8)], [2(3.5)], and [3(7)] keys, while turning the radio on, to enter the alignment mode.
- Rotate the Main Tuning Dial knob to select the alignment parameter "d29 tCA."
- Rotate the [SUB(VFO-B)] knob so that the VFO-B frequency display shows "0."

- Press the PTT switch without microphone input, then rotate the [SUB(VFO-B)] knob for 35 W (± 5 W) on the Wattmeter.
- Release the PTT switch.
- Press and hold in the [MENU] button for 2 seconds to save the new setting and exit from the alignment mode.

ALIGNMENT MENU	VFO-B FREQ. DISPLAY	PO METER	WATTMETER	SUB S-METER	
1.9 MHz	d18bP1h	0	100 W	100 W	S-9
	d18bP1h	0	50 W	50 W	S-9
	d18cP50	0	20 W	20 W	S-9
	d18dP20	0	10 W	10 W	S-9
	d18EP10	0	5 W	5 W	S-9
3.5 MHz	d19AP2h	0	100 W	100 W	S-9
	d19bP1h	0	50 W	50 W	S-9
	d19cP50	0	20 W	20 W	S-9
	d19dP20	0	10 W	10 W	S-9
	d20EP10	0	5 W	5 W	S-9
7 MHz	d20AP2h	0	100 W	100 W	S-9
	d20bP1h	0	50 W	50 W	S-9
	d20cP50	0	20 W	20 W	S-9
	d20dP20	0	10 W	10 W	S-9
	d20EP10	0	5 W	5 W	S-9
10 MHz	d21AP2h	0	100 W	100 W	S-9
	d21bP1h	0	50 W	50 W	S-9
	d21cP50	0	20 W	20 W	S-9
	d21dP20	0	10 W	10 W	S-9
	d21EP10	0	5 W	5 W	S-9
14 MHz	d22AP2h	0	100 W	100 W	S-9
	d22bP1h	0	50 W	50 W	S-9
	d22cP50	0	20 W	20 W	S-9
	d22dP20	0	10 W	10 W	S-9
	d22EP10	0	5 W	5 W	S-9
18 MHz	d23AP2h	0	100 W	100 W	S-9
	d23bP1h	0	50 W	50 W	S-9
	d23cP50	0	20 W	20 W	S-9
	d23dP20	0	10 W	10 W	S-9
	d23EP10	0	5 W	5 W	S-9
21 MHz	d24AP2h	0	100 W	100 W	S-9
	d24bP1h	0	50 W	50 W	S-9
	d24cP50	0	20 W	20 W	S-9
	d24dP20	0	10 W	10 W	S-9
	d24EP10	0	5 W	5 W	S-9
24 MHz	d25AP2h	0	100 W	100 W	S-9
	d25bP1h	0	50 W	50 W	S-9
	d25cP50	0	20 W	20 W	S-9
	d25dP20	0	10 W	10 W	S-9
	d25EP10	0	5 W	5 W	S-9
28 MHz	d26AP2h	0	100 W	100 W	S-9
	d26bP1h	0	50 W	50 W	S-9
	d26cP50	0	20 W	20 W	S-9
	d26dP20	0	10 W	10 W	S-9
	d26EP10	0	5 W	5 W	S-9
50 MHz	d27AP2h	0	100 W	100 W	S-9
	d27bP1h	0	50 W	50 W	S-9
	d27cP50	0	20 W	20 W	S-9
	d27dP20	0	10 W	10 W	S-9
	d27EP10	0	5 W	5 W	S-9

REV-ALC Adjustment

- ❑ Press and hold in the [1(1.8)], [2(3.5)], and [3(7)] keys, while turning the radio on, to enter the alignment mode.
- ❑ Rotate the Main Tuning Dial knob to select the alignment parameter “d40 rAC.”
- ❑ Rotate the [SUB(VFO-B)] knob so that the VFO-B frequency display shows “060.”
- ❑ Perform the same procedures for the Alignment Menus “d40 rAC” through “d49 rAC.”
- ❑ Press and hold in the [MENU] button for 2 seconds to save the new setting and exit from the alignment mode.

FM MAX Deviation Adjustment

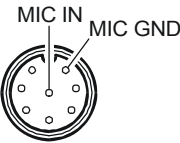
- ❑ Connect the Dummy Load, Wattmeter, and Deviation Meter to the “ANT 1” Jack.
 - ❑ Set the Main Band (VFO-A) frequency to 28.700 MHz in the FM mode.
 - ❑ Connect the Audio Generator to pin 8 of the MIC jack (pin 7: GND), then set the output level to 10 mV @1 kHz.
- 
- ❑ Press and hold in the [1(1.8)], [2(3.5)], and [3(7)] keys, while turning the radio on, to enter the alignment mode.
 - ❑ Rotate the Main Tuning Dial knob to select the alignment parameter “d51 F45.”
 - ❑ Press the PTT switch, then rotate the [SUB(VFO-B)] knob for 4.5 kHz (± 0.2 kHz) on the Deviation Meter.
 - ❑ Release the PTT switch.
 - ❑ Set the Main Band (VFO-A) operating mode to the FM-N mode.
 - ❑ Rotate the Main Tuning Dial knob to select the alignment parameter “d52 F23.”
 - ❑ Press the PTT switch, then rotate the [SUB(VFO-B)] knob for 2.25 kHz (± 0.15 kHz) on the Deviation Meter.
 - ❑ Release the PTT switch.
 - ❑ Press and hold in the [MENU] button for 2 seconds to save the new setting and exit from the alignment mode.

COMP Meter Adjustment

- ❑ Press and hold in the [1(1.8)], [2(3.5)], and [3(7)] keys, while turning the radio on, to enter the alignment mode.
- ❑ Rotate the Main Tuning Dial knob to select the alignment parameter “d57 C10,” then rotate the [SUB(VFO-B)] knob for “10 dB” on the COMP meter.
- ❑ Rotate the Main Tuning Dial knob to select the alignment parameter “d58 C20,” then rotate the [SUB(VFO-B)] knob for “20 dB” on the COMP meter.
- ❑ Rotate the Main Tuning Dial knob to select the alignment parameter “d59 C30,” then rotate the [SUB(VFO-B)] knob so that the COMP meter deflects to full scale.
- ❑ Press and hold in the [MNU] key for 2 seconds to exit from the alignment mode.

SWR Meter Adjustment

- ❑ Switch the external display to “SWR Monitor” page.
- ❑ Connect the 50-Ohm Dummy Load and Wattmeter to the “ANT 1” Jack, then set the [METER] switch to the “SWR” position.
- ❑ Disconnect the 3-pin plug from J1015 on the MAIN Unit, then apply a 4.2 V DC voltage to pin 2 of J1015, and 2.1 V DC to pin 3 of J1015.
- ❑ Press and hold in the [1(1.8)], [2(3.5)], and [3(7)] keys, while turning the radio on, to enter the alignment mode.
- ❑ Rotate the Main Tuning Dial knob to select the alignment parameter “d53cS30.”
- ❑ Press the PTT switch, then rotate the [VRF] knob so that the SWR meter (on the external display) reading is “3.0.” The SWR meter reading (3.0) is broad (few points). Therefore, set the [VRF] knob to the center of this broad range.
- ❑ Rotate the [SUB(VFO-B)] knob so that the SWR meter (on the front panel) reading is “3.0.”
- ❑ Release the PTT switch.
- ❑ Perform the same procedures for the Alignment Menus “d54cS30” and “d55cS30.”
- ❑ Apply a 4.2 V DC voltage to pin 2 of J1015, and 1.4 V DC to pin 3 of J1015.
- ❑ Rotate the Main Tuning Dial knob to select the alignment parameter “d53bS20.”
- ❑ Press the PTT switch, then rotate the [SUB(VFO-B)] knob so that the SWR meter (on the front panel) reading is “2.0.”
- ❑ Release the PTT switch.

Alignment

- ❑ Perform the same procedures for the Alignment Menus “d54bS20” and “d55bS20.”
- ❑ Apply a 4.2 V DC voltage to pin 2 of J1015, and 0.84 V DC to pin 3 of J1015.
- ❑ Rotate the Main Tuning Dial knob to select the alignment parameter “d53AS15.”
- ❑ Press the PTT switch, then rotate the [SUB(VFO-B)] knob so that the SWR meter (on the front panel) reading is “1.5.”
- ❑ Release the PTT switch.
- ❑ Perform the same procedures for the Alignment Menus “d54AS15” and “d55AS15.”
- ❑ Press and hold in the [MENU] button for 2 seconds to save the new setting and exit from the alignment mode.

ID Meter Adjustment

- ❑ Connect the 50-Ohm Dummy Load and Wattmeter to the “ANT 1” Jack, then set the METER switch to the “ID” position.
- ❑ Remove the jumper wire from TP5031 and TP5032 on the PA-A Unit, then connect the DC ammeter (20-A range) between TP5031 (+) and TP5032 (-).
- ❑ Set the Main Band (VFO-A) frequency to 14.200 MHz in the CW mode, then set the [RF PWR] knob fully clockwise position.
- ❑ Press and hold in the [1(1.8)], [2(3.5)], and [3(7)] keys, while turning the radio on, to enter the alignment mode.
- ❑ Rotate the Main Tuning Dial knob to select the alignment parameter “d56 Idd.”
- ❑ Press the PTT switch, then rotate the [SUB(VFO-B)] knob so that the ID meter reading is same as that on the DC ammeter.
- ❑ Press the [ENT] key, then release the PTT switch.
- ❑ Press and hold in the [MENU] button for 2 seconds to save the new setting and exit from the alignment mode.
- ❑ Disconnect the DC ammeter, then re-connect the jumper wire between TP5031 and TP5032.

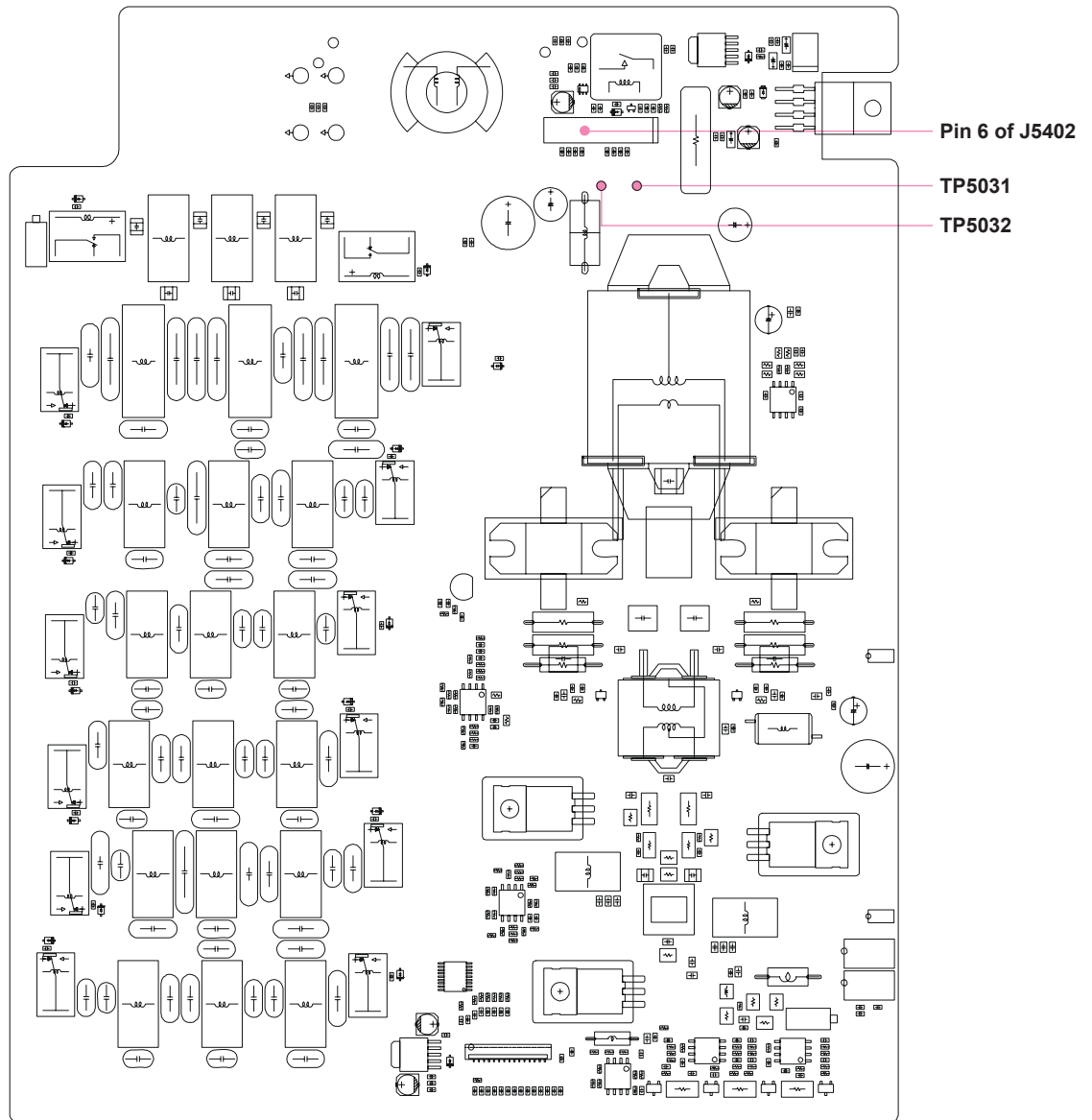

PA-A UNIT ALIGNMENT POINTS

Provided by
YAESU museum

Downloaded by
RadioAmateur.EU

Alignment

Note

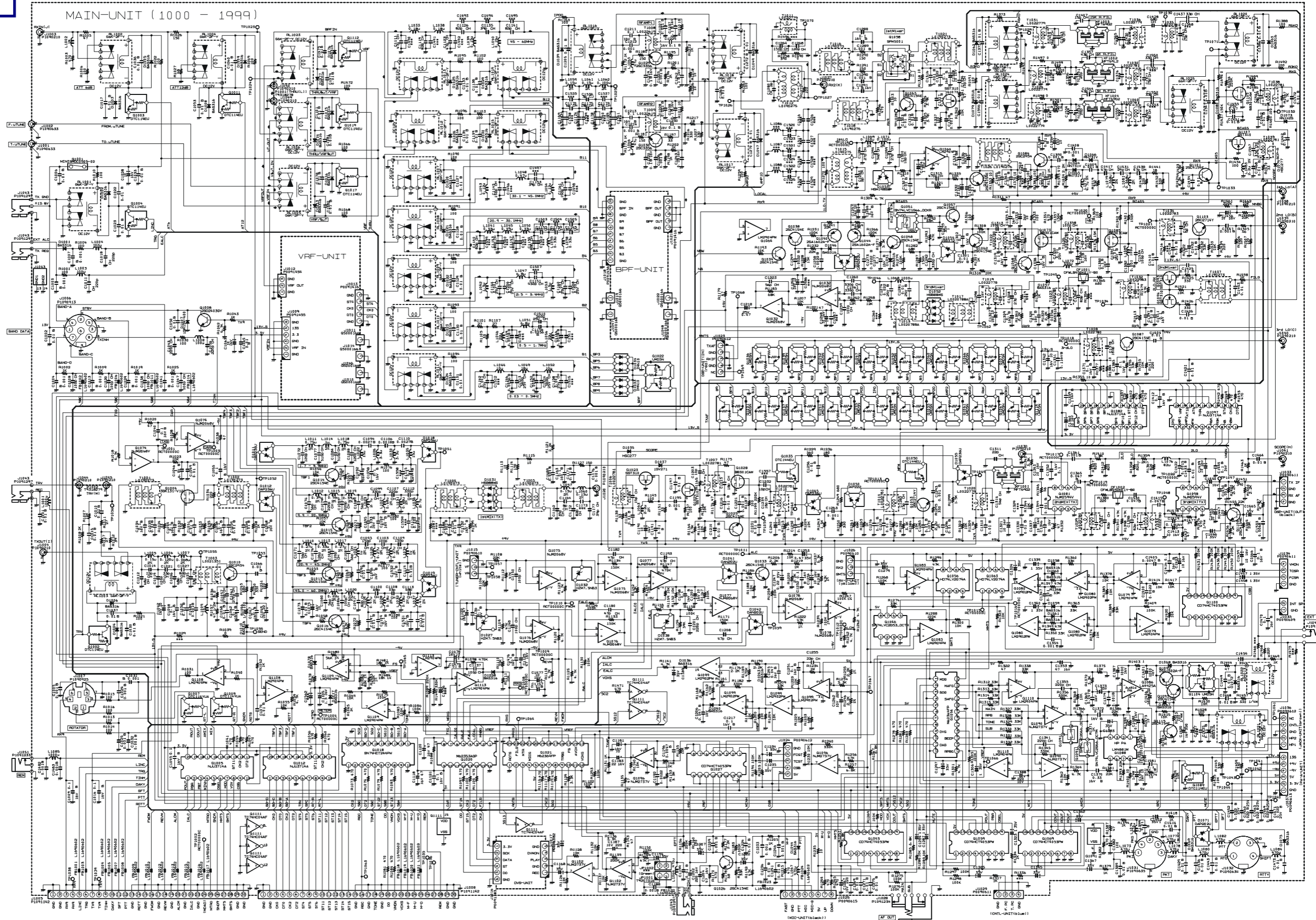

MAIN Unit (Lot. 1)

Note

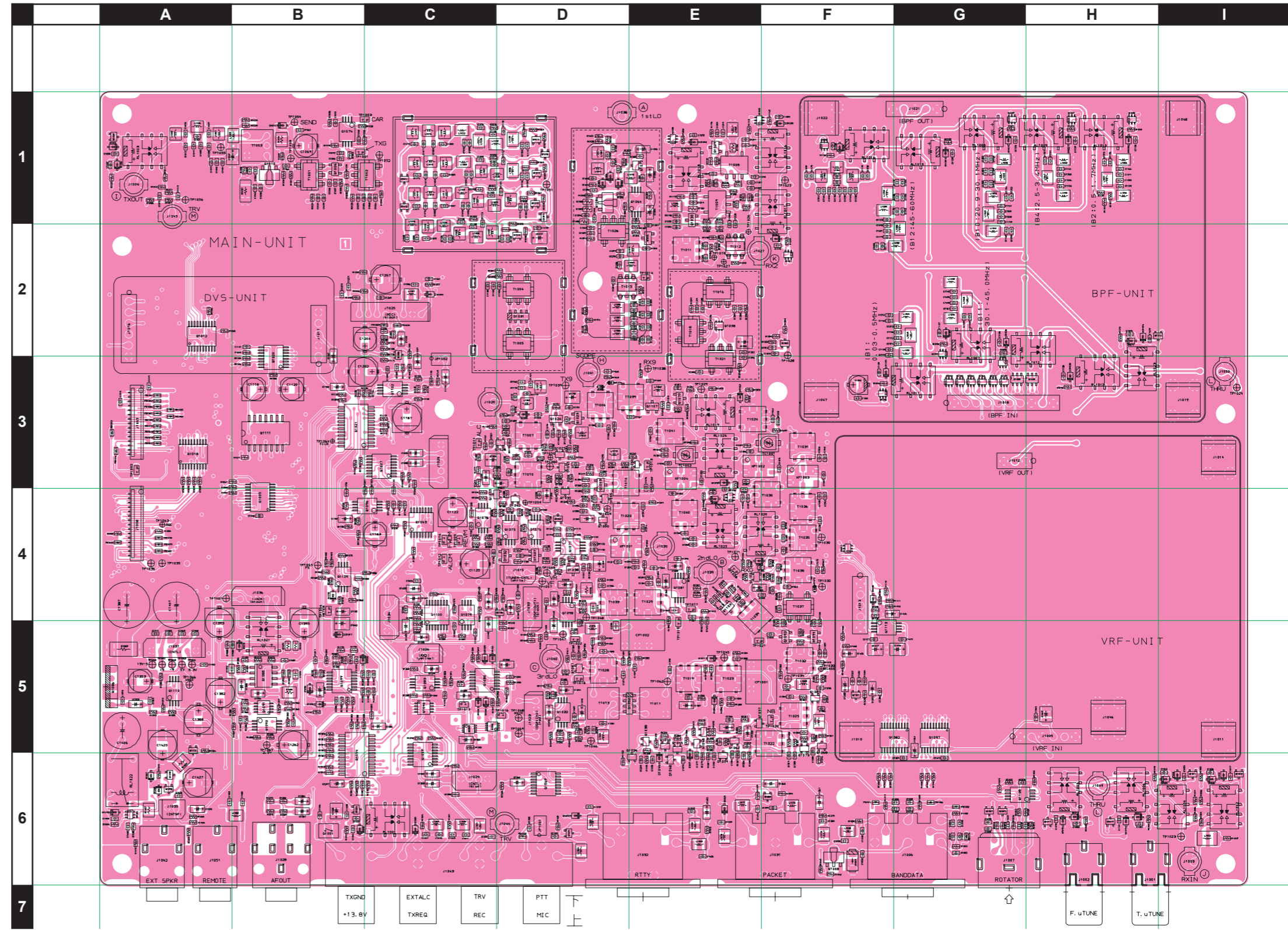
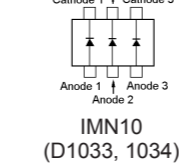
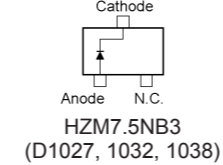
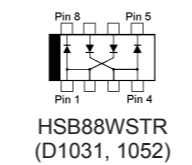
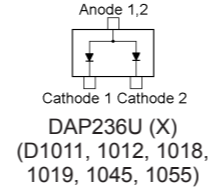
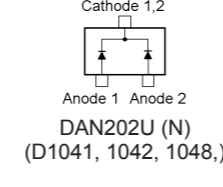
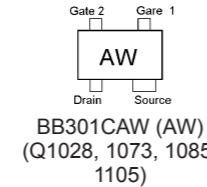
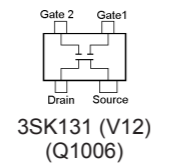
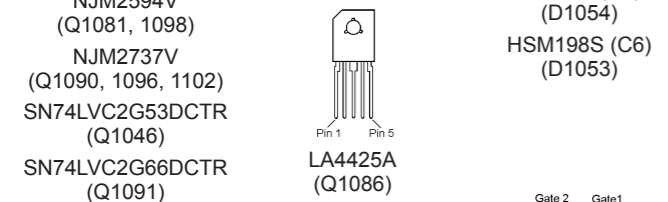
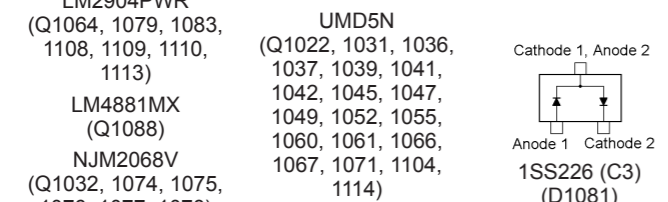
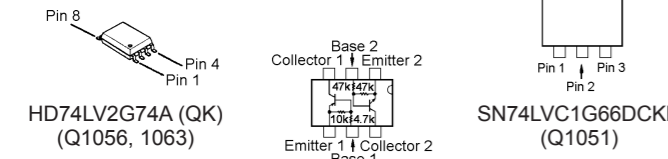
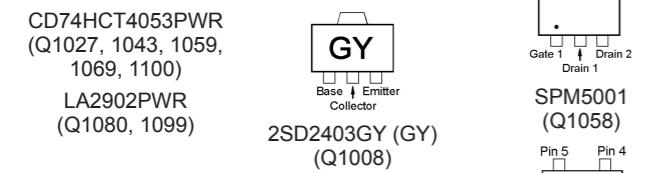
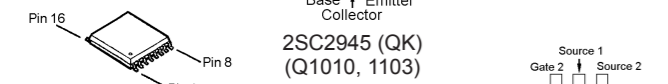
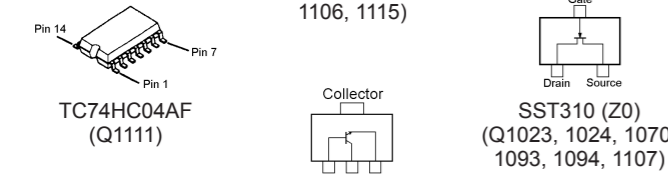
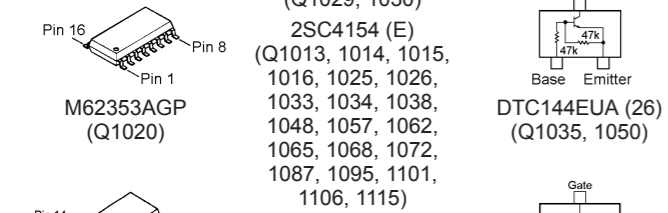
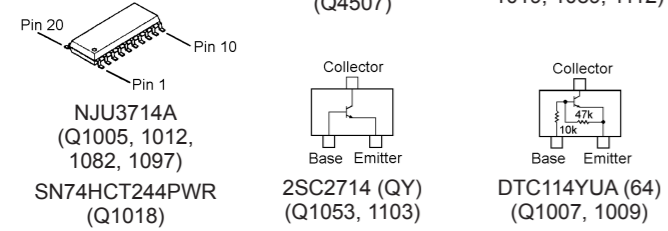
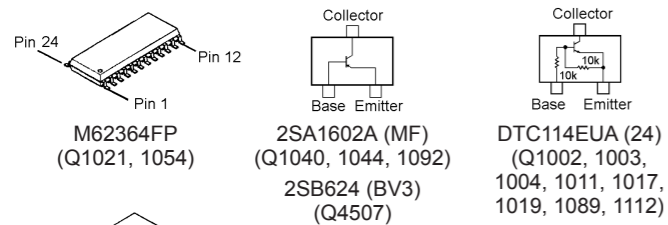

MAIN Unit (Lot. 1)

Parts Layout (Side A)

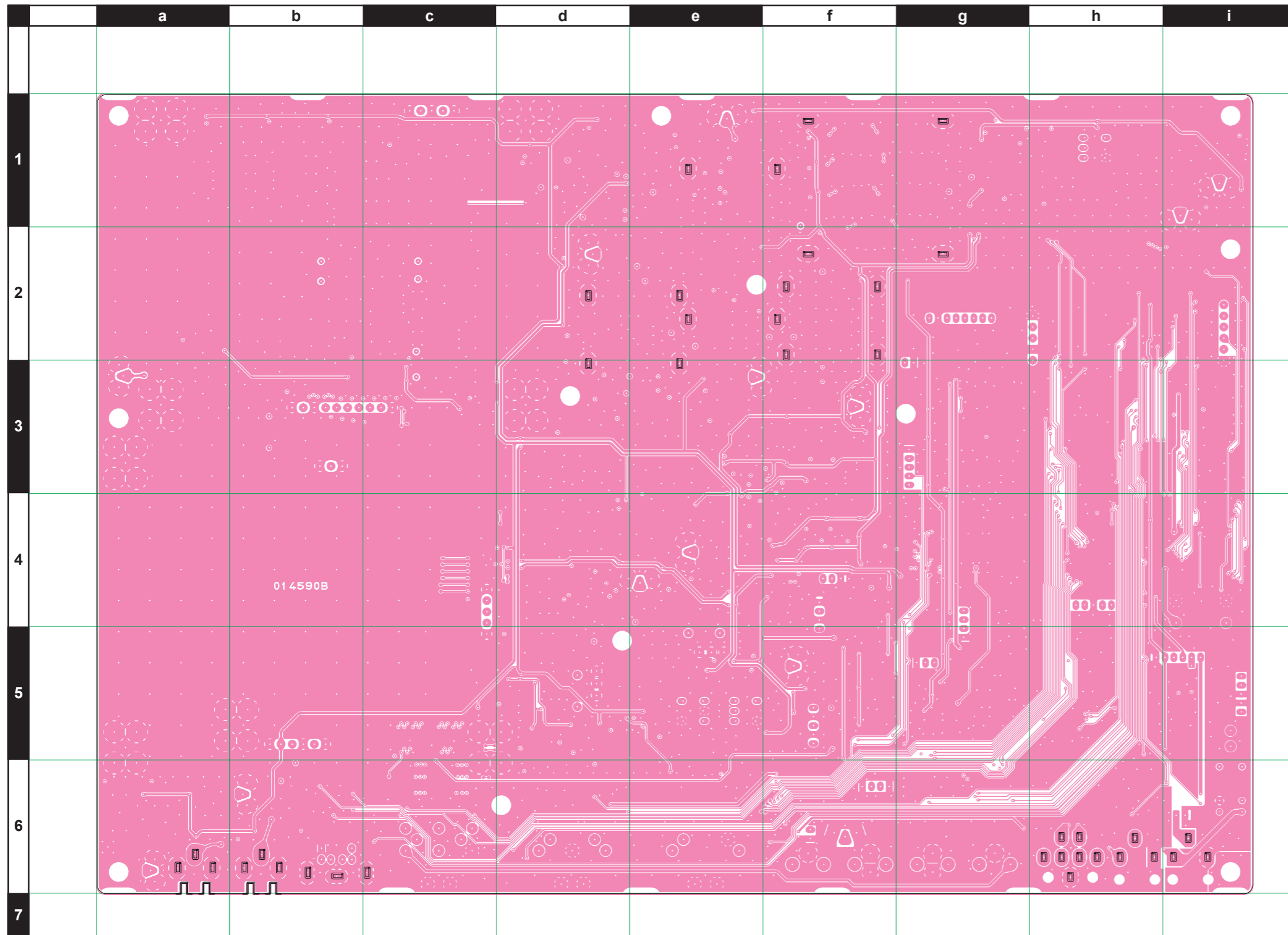

Provided by
YAESU museum

Downloaded by
RadioAmateur.EU

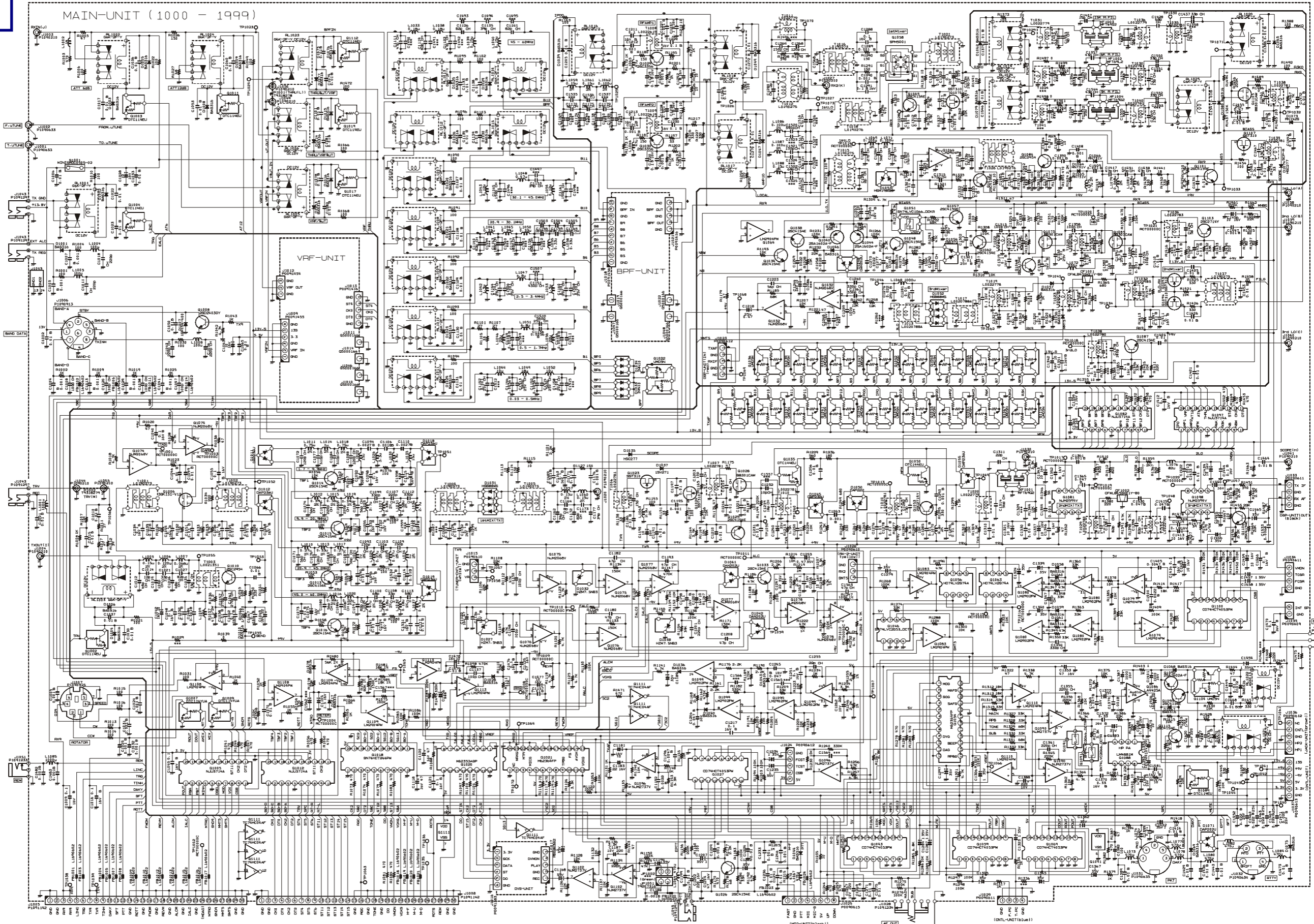

MAIN Unit (Lot. 2~5)

Note

MAIN Unit (Lot. 2~5)

Parts Layout (Side A)

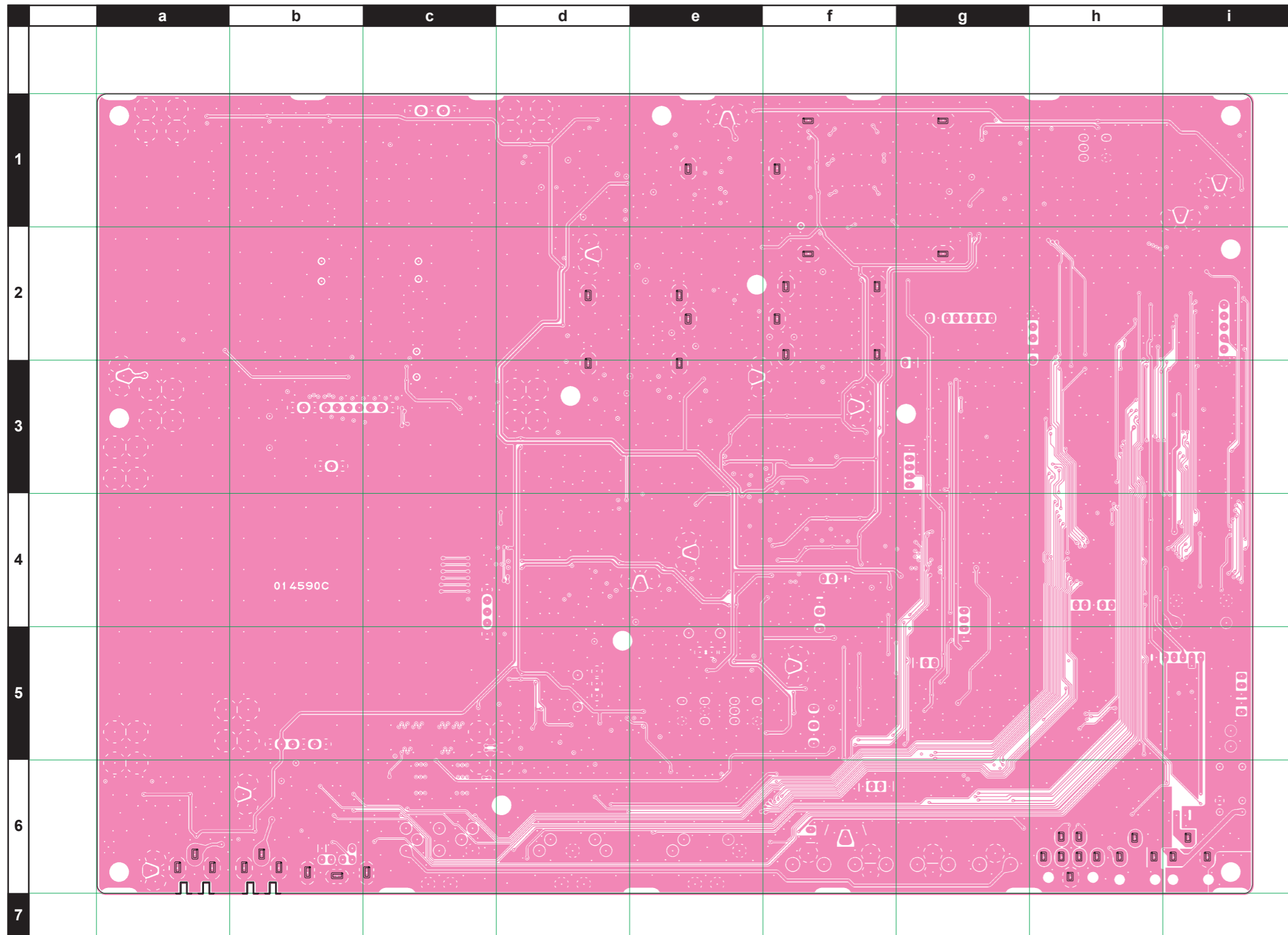

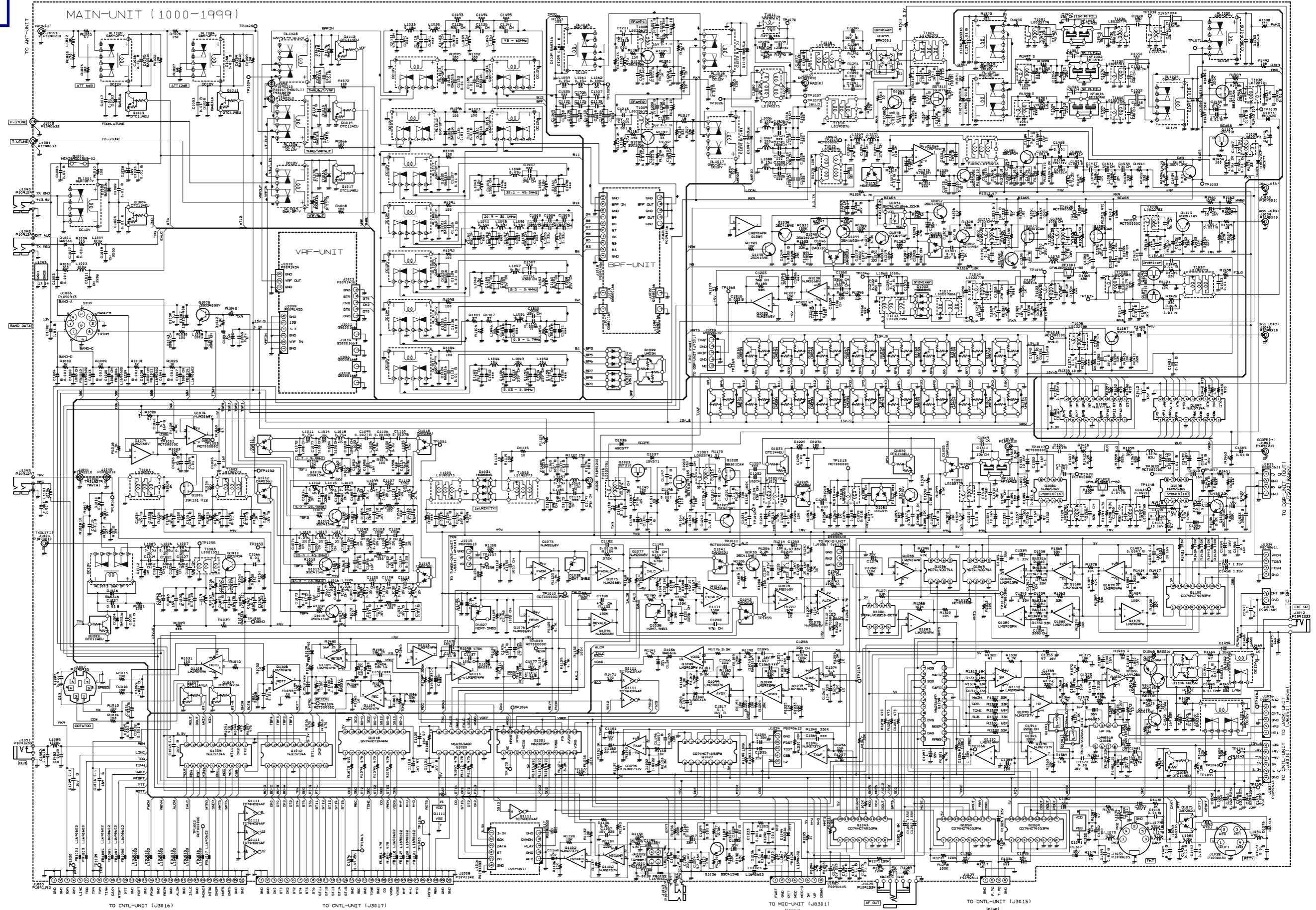

MAIN Unit (Lot. 6~)

Note

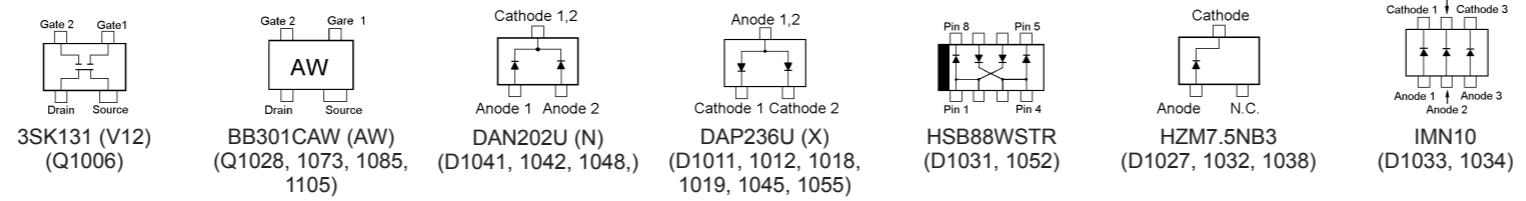
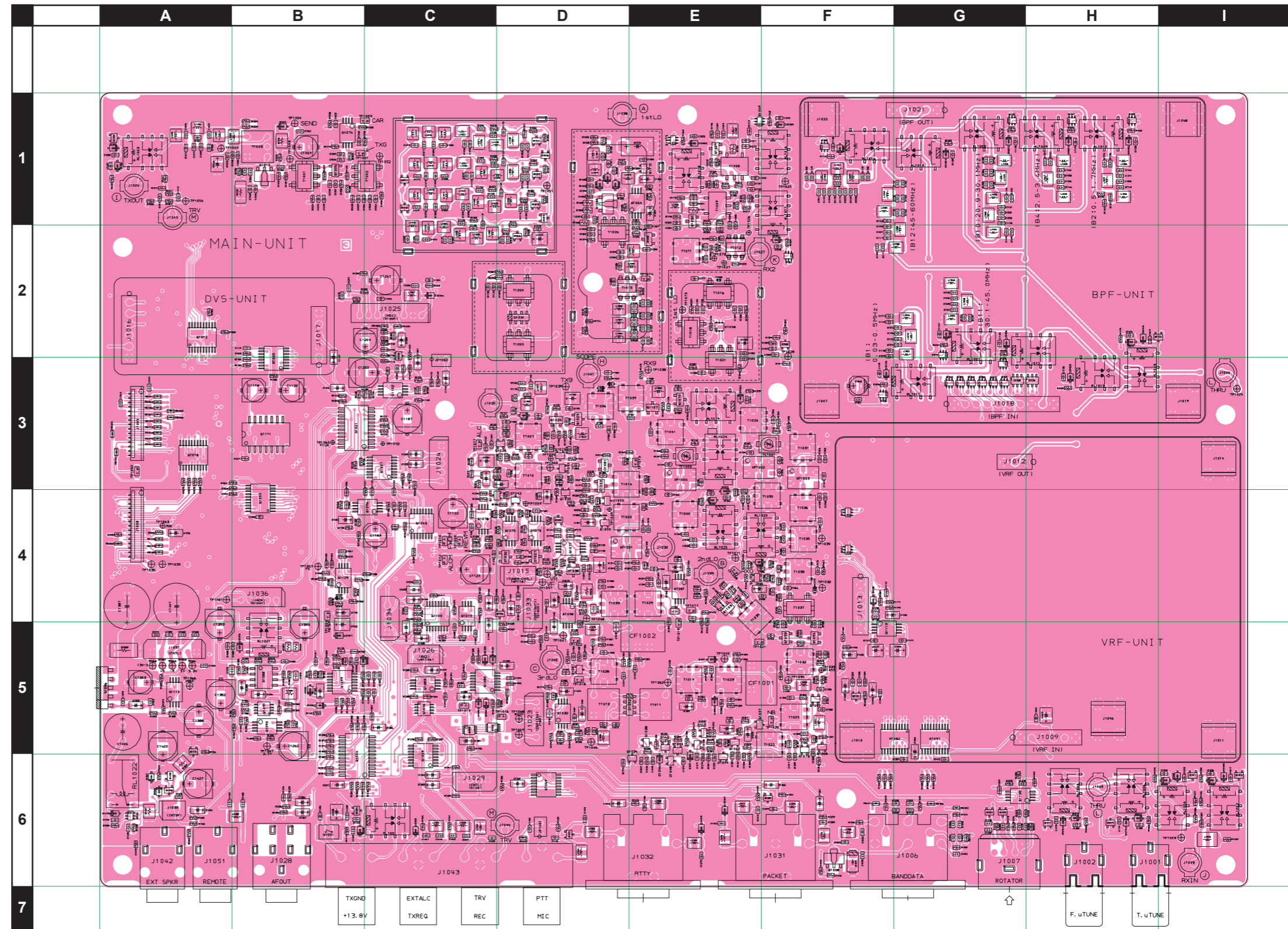
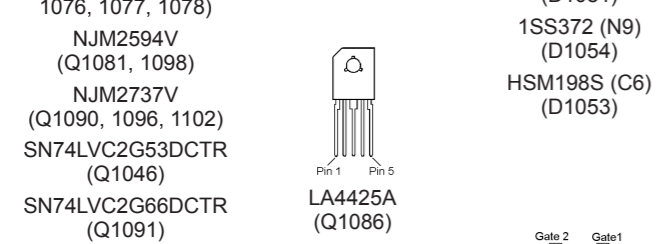
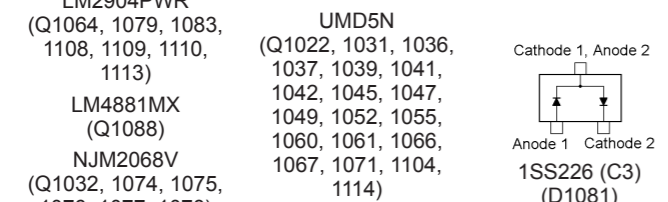
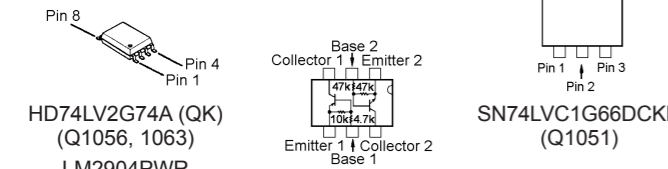
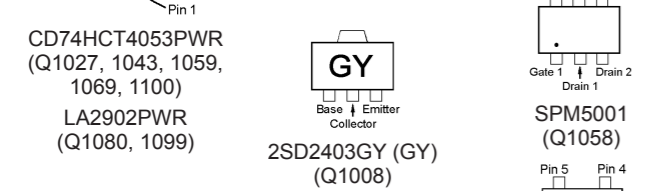
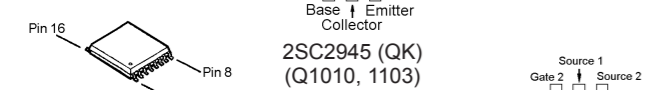
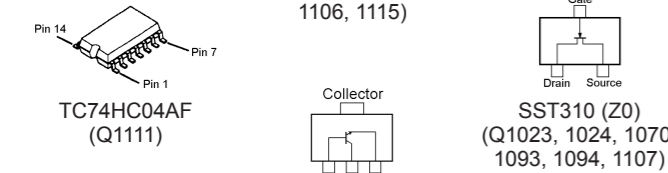
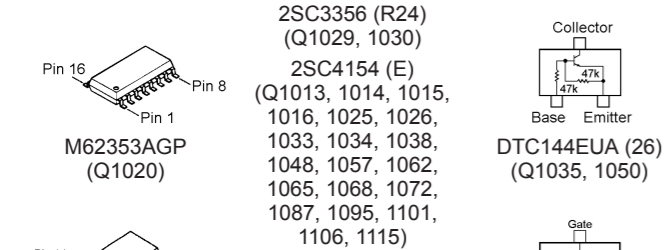
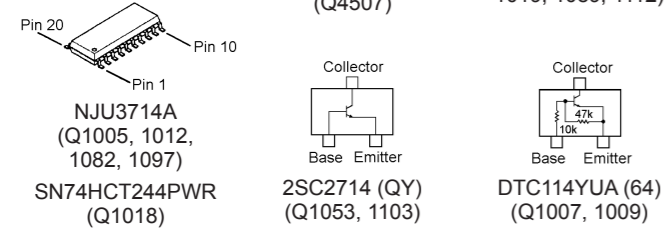
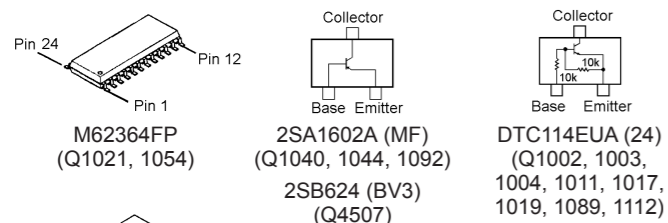

MAIN Unit (Lot. 6~)

Parts Layout (Side A)

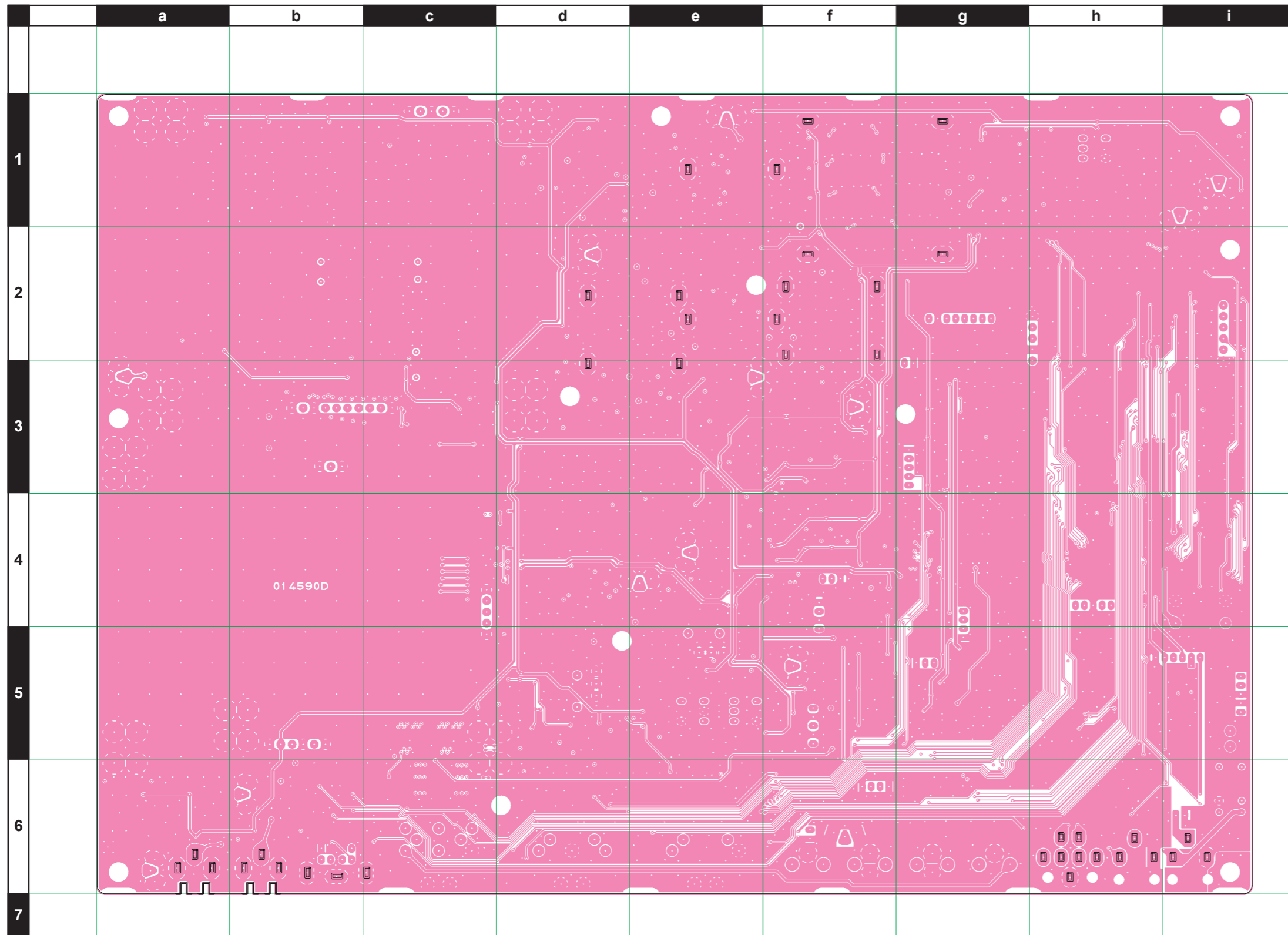

MAIN Unit

Parts List

REF	DESCRIPTION	VALUE	V/W	TOL.	MFR'S DESIG	VXSTD P/N	VERS.	LOT	SIDE	LAY ADR
PCB with Components						CB3483001				
Printed Circuit Board						FR014590B		1		
						FR014590C		2-		
						FR014590D		6-		
C 1001	CHIP CAP.	0.01uF	50V	B	GRM188B11H103KA01D	K22174823		1-	A	C6
C 1002	CHIP CAP.	0.01uF	50V	B	GRM188B11H103KA01D	K22174823		1-	A	G6
C 1003	CHIP CAP.	0.001uF	50V	B	GRM188B11H102KA01D	K22174821		1-	A	C6
C 1004	CHIP CAP.	0.001uF	50V	B	GRM188B11H102KA01D	K22174821		1-	A	G6
C 1005	CHIP CAP.	0.001uF	50V	B	GRM188B11H102KA01D	K22174821		1-	A	G6
C 1006	CHIP CAP.	0.01uF	50V	B	GRM188B11H103KA01D	K22174823		1-	A	B6
C 1007	CHIP CAP.	0.001uF	50V	B	GRM188B11H102KA01D	K22174821		1-	A	C6
C 1008	CHIP CAP.	100pF	50V	CH	GRM1882C1H101JA01D	K22174235		1-	A	G6
C 1009	CHIP CAP.	0.1uF	16V	B	GRM188B11C104KA01D	K22124805		1-	A	A3
C 1010	CHIP CAP.	0.01uF	50V	B	GRM188B11H103KA01D	K22174823		1-	A	A1
C 1011	CHIP CAP.	220pF	50V	CH	GRM1882C1H221JA01D	K22174243		1-	A	C6
C 1012	CHIP CAP.	68pF	50V	CH	GRM1882C1H680JA01D	K22174231		1-	A	A1
C 1013	CHIP CAP.	0.001uF	50V	B	GRM188B11H102KA01D	K22174821		1-	A	G6
C 1014	CHIP CAP.	12pF	50V	CH	GRM1882C1H120JA01D	K22174213		1-	A	A1
C 1015	CHIP CAP.	0.01uF	50V	B	GRM188B11H103KA01D	K22174823		1-	A	A1
C 1016	CHIP CAP.	0.1uF	16V	B	GRM188B11C104KA01D	K22124805		1-	A	A3
C 1017	CHIP CAP.	0.01uF	50V	B	GRM188B11H103KA01D	K22174823		1-	A	I6
C 1018	CHIP CAP.	220pF	50V	CH	GRM1882C1H221JA01D	K22174243		1-	A	C6
C 1019	CHIP CAP.	100pF	50V	CH	GRM1882C1H101JA01D	K22174235		1-	A	A1
C 1020	CHIP CAP.	100pF	50V	CH	GRM1882C1H101JA01D	K22174235		1-	A	G6
C 1021	CHIP CAP.	33pF	50V	CH	GRM1882C1H330JA01D	K22174223		1-	A	A1
C 1022	CHIP CAP.	0.01uF	50V	B	GRM188B11H103KA01D	K22174823		1-	A	B6
C 1023	CHIP CAP.	0.01uF	50V	B	GRM188B11H103KA01D	K22174823		1-	A	B6
C 1024	CHIP CAP.	0.001uF	50V	B	GRM188B11H102KA01D	K22174821		1-	A	G6
C 1025	CHIP CAP.	0.001uF	50V	B	GRM188B11H102KA01D	K22174821		1-	A	G6
C 1026	CHIP CAP.	68pF	50V	CH	GRM1882C1H680JA01D	K22174231		1-	A	A1
C 1027	CHIP CAP.	82pF	50V	CH	GRM1882C1H820JA01D	K22174233		1-	A	A1
C 1028	CHIP TA.CAP.	10uF	16V		TEMSVB21C106M-8R	K78120025		1-	A	B6
C 1029	CHIP CAP.	0.001uF	50V	B	GRM188B11H102KA01D	K22174821		1-	A	G6
C 1030	CHIP CAP.	0.01uF	50V	B	GRM188B11H103KA01D	K22174823		1-	A	A1
C 1031	CHIP CAP.	0.001uF	50V	B	GRM188B11H102KA01D	K22174821		1-	A	G6
C 1032	CHIP CAP.	0.001uF	50V	B	GRM188B11H102KA01D	K22174821		1-	A	G6
C 1033	CHIP CAP.	0.01uF	50V	B	GRM188B11H103KA01D	K22174823		1-	A	B6
C 1034	CHIP CAP.	0.1uF	16V	B	GRM188B11C104KA01D	K22124805		1-	A	B1
C 1035	CHIP CAP.	33pF	50V	CH	GRM1882C1H330JA01D	K22174223		1-	A	A1
C 1036	CHIP CAP.	0.01uF	50V	B	GRM188B11H103KA01D	K22174823		1-	A	I6
C 1037	CHIP CAP.	0.01uF	50V	B	GRM188B11H103KA01D	K22174823		1-	A	A1
C 1038	CHIP CAP.	100pF	50V	CH	GRM1882C1H101JA01D	K22174235		1-	A	G6
C 1039	CHIP CAP.	0.01uF	50V	B	GRM188B11H103KA01D	K22174823		1-	A	B1
C 1040	CHIP CAP.	0.1uF	16V	B	GRM188B11C104KA01D	K22124805		1-	A	B1
C 1041	CHIP CAP.	0.001uF	50V	B	GRM188B11H102KA01D	K22174821		1-	A	G6
C 1042	CHIP TA.CAP.	10uF	16V		TEMSVB21C106M-8R	K78120025		1-	A	B1
C 1043	CHIP CAP.	220pF	50V	CH	GRM1882C1H221JA01D	K22174243		1-	A	F6
C 1044	CHIP CAP.	0.1uF	16V	B	GRM188B11C104KA01D	K22124805		1-	A	B1
C 1045	CHIP CAP.	0.1uF	16V	B	GRM188B11C104KA01D	K22124805		1-	A	B4
C 1046	CHIP CAP.	1uF	6.3V	B	GRM188B10J105KA01D	K22084801		1-	A	B1
C 1047	CHIP CAP.	100pF	50V	CH	GRM1882C1H101JA01D	K22174235		1-	A	G6
C 1048	CHIP CAP.	0.1uF	16V	B	GRM188B11C104KA01D	K22124805		1-	A	A1
C 1049	CHIP CAP.	0.01uF	50V	B	GRM188B11H103KA01D	K22174823		1-	A	B1
C 1050	CHIP CAP.	0.01uF	50V	B	GRM188B11H103KA01D	K22174823		1-	A	F6
C 1051	CHIP CAP.	0.01uF	50V	B	GRM188B11H103KA01D	K22174823		1-	A	B1
C 1052	CHIP CAP.	0.01uF	50V	B	GRM188B11H103KA01D	K22174823		1-	A	A1
C 1053	CHIP CAP.	0.01uF	50V	B	GRM188B11H103KA01D	K22174823		1-	A	I6
C 1054	CHIP CAP.	220pF	50V	CH	GRM1882C1H221JA01D	K22174243		1-	A	F6
C 1055	CHIP CAP.	0.1uF	16V	B	GRM188B11C104KA01D	K22124805		1-	A	B1
C 1056	CHIP CAP.	0.1uF	16V	B	GRM188B11C104KA01D	K22124805		1-	A	B1
C 1057	CHIP CAP.	270pF	50V	CH	GRM1882C1H271JA01D	K22174251		1-	A	B1
C 1058	CHIP CAP.	0.01uF	50V	B	GRM188B11H103KA01D	K22174823		1-	A	B1
C 1059	CHIP CAP.	0.01uF	50V	B	GRM188B11H103KA01D	K22174823		1-	A	B1
C 1060	CHIP CAP.	0.01uF	50V	B	GRM188B11H103KA01D	K22174823		1-	A	I6
C 1061	CHIP CAP.	270pF	50V	CH	GRM1882C1H271JA01D	K22174251		1-	A	B1
C 1062	CHIP CAP.	0.1uF	16V	B	GRM188B11C104KA01D	K22124805		1-	A	B1
C 1063	CHIP TA.CAP.	10uF	16V		TEMSVB21C106M-8R	K78120025		1-	A	H5
C 1064	CHIP CAP.	0.01uF	50V	B	GRM188B11H103KA01D	K22174823		1-	A	C1
C 1065	CHIP CAP.	0.01uF	50V	B	GRM188B11H103KA01D	K22174823		1-	A	H5
C 1066	CHIP CAP.	0.01uF	50V	B	GRM188B11H103KA01D	K22174823		1-	A	B1
C 1067	CHIP CAP.	0.1uF	16V	B	GRM188B11C104KA01D	K22124805		1-	A	B1
C 1068	CHIP CAP.	0.1uF	16V	B	GRM188B11C104KA01D	K22124805		1-	A	C1
C 1069	AL.ELECTRO.CAP.	22uF	16V		EEE1CA220SR	K48120024		1-	A	B1

MAIN Unit

Parts List

REF	DESCRIPTION	VALUE	V/W	TOL.	MFR'S DESIG	VXSTD P/N	VERS.	LOT	SIDE	LAY ADR
C 1070	CHIP CAP.	0.01uF	50V	B	GRM188B11H103KA01D	K22174823		1-	A	G6
C 1071	CHIP CAP.	56pF	50V	CH	GRM1882C1H560JA01D	K22174229		1-	A	C1
C 1072	CHIP CAP.	120pF	50V	CH	GRM1882C1H121JA01D	K22174237		1-	A	C1
C 1073	CHIP CAP.	0.01uF	50V	B	GRM188B11H103KA01D	K22174823		1-	A	D2
C 1074	CHIP CAP.	56pF	50V	CH	GRM1882C1H560JA01D	K22174229		1-	A	C1
C 1075	CHIP TA.CAP.	10uF	16V		TEMSVB21C106M-8R	K78120025		1-	A	D2
C 1076	CHIP CAP.	120pF	50V	CH	GRM1882C1H121JA01D	K22174237		1-	A	C1
C 1077	CHIP CAP.	510pF	50V	CH	GRM1882C1H511JA01D	K22174257		1-	A	C1
C 1078	CHIP CAP.	0.01uF	50V	B	GRM188B11H103KA01D	K22174823		1-	A	H6
C 1079	CHIP CAP.	220pF	50V	CH	GRM1882C1H221JA01D	K22174243		1-	A	C1
C 1080	CHIP CAP.	56pF	50V	CH	GRM1882C1H560JA01D	K22174229		1-	A	C2
C 1081	CHIP CAP.	0.01uF	50V	B	GRM188B11H103KA01D	K22174823		1-	A	H6
C 1082	CHIP CAP.	0.01uF	50V	B	GRM188B11H103KA01D	K22174823		1-	A	H6
C 1083	CHIP CAP.	120pF	50V	CH	GRM1882C1H121JA01D	K22174237		1-	A	C1
C 1084	CHIP CAP.	510pF	50V	CH	GRM1882C1H511JA01D	K22174257		1-	A	C1
C 1085	CHIP CAP.	220pF	50V	CH	GRM1882C1H221JA01D	K22174243		1-	A	C1
C 1086	CHIP CAP.	100pF	50V	CH	GRM1882C1H101JA01D	K22174235		1-	A	C2
C 1087	CHIP CAP.	56pF	50V	CH	GRM1882C1H560JA01D	K22174229		1-	A	C1
C 1088	CHIP CAP.	120pF	50V	CH	GRM1882C1H121JA01D	K22174237		1-	A	C1
C 1089	CHIP CAP.	56pF	50V	CH	GRM1882C1H560JA01D	K22174229		1-	A	C1
C 1090	CHIP CAP.	0.01uF	50V	B	GRM188B11H103KA01D	K22174823		1-	A	C1
C 1091	CHIP CAP.	82pF	50V	CH	GRM1882C1H820JA01D	K22174233		1-	A	C2
C 1092	CHIP CAP.	0.1uF	16V	B	GRM188B11C104KA01D	K22124805		1-	A	C1
C 1093	CHIP CAP.	150pF	50V	CH	GRM1882C1H151JA01D	K22174239		1-	A	C1
C 1094	CHIP CAP.	0.0027uF	50V	B	GRM188B11H272KA01D	K22174829		1-	A	C1
C 1095	CHIP CAP.	0.033uF	16V	R	GRM188R11C333KA01D	K22124801		1-	A	C1
C 1096	CHIP CAP.	0.1uF	16V	B	GRM188B11C104KA01D	K22124805		1-	A	C1
C 1097	CHIP CAP.	0.01uF	50V	B	GRM188B11H103KA01D	K22174823		1-	A	C2
C 1098	CHIP CAP.	0.1uF	16V	B	GRM188B11C104KA01D	K22124805		1-	A	C1
C 1099	CHIP CAP.	330pF	50V	CH	GRM1882C1H331JA01D	K22174253		1-	A	C1
C 1100	CHIP CAP.	68pF	50V	CH	GRM1882C1H680JA01D	K22174231		1-	A	C1
C 1101	CHIP CAP.	0.01uF	50V	B	GRM188B11H103KA01D	K22174823		1-	A	H6
C 1102	CHIP CAP.	0.1uF	16V	B	GRM188B11C104KA01D	K22124805		1-	A	C1
C 1103	CHIP CAP.	100pF	50V	CH	GRM1882C1H101JA01D	K22174235		1-	A	C1
C 1104	CHIP CAP.	0.1uF	16V	B	GRM188B11C104KA01D	K22124805		1-	A	C2
C 1105	CHIP TA.CAP.	1.5uF	16V		TESVA1C155M1-8R	K78120020		1-	A	B4
C 1106	CHIP CAP.	0.0018uF	50V	B	GRM188B11H182KA01D	K22174828		1-	A	C1
C 1107	CHIP CAP.	220pF	50V	CH	GRM1882C1H221JA01D	K22174243		1-	A	C1
C 1108	CHIP CAP.	33pF	50V	CH	GRM1882C1H330JA01D	K22174223		1-	A	C2
C 1109	CHIP CAP.	150pF	50V	CH	GRM1882C1H151JA01D	K22174239		1-	A	D1
C 1110	CHIP CAP.	0.0027uF	50V	B	GRM188B11H272KA01D	K22174829		1-	A	D1
C 1111	CHIP CAP.	47pF	50V	CH	GRM1882C1H470JA01D	K22174227		1-	A	F2
C 1112	CHIP CAP.	330pF	50V	CH	GRM1882C1H331JA01D	K22174253		1-	A	D1
C 1113	CHIP CAP.	68pF	50V	CH	GRM1882C1H680JA01D	K22174231		1-	A	C1
C 1114	CHIP CAP.	0.01uF	50V	B	GRM188B11H103KA01D	K22174823		1-	A	D1
C 1115	CHIP CAP.	0.1uF	16V	B	GRM188B11C104KA01D	K22124805		1-	A	D1
C 1116	CHIP CAP.	0.033uF	16V	R	GRM188R11C333KA01D	K22124801		1-	A	D1
C 1117	CHIP CAP.	0.01uF	50V	B	GRM188B11H103KA01D	K22174823		1-	A	D2
C 1118	AL.ELECTRO.CAP.	47uF	16V		EEE1CA470WR	K48120025		1-	A	B3
C 1119	CHIP CAP.	82pF	50V	CH	GRM1882C1H820JA01D	K22174233		1-	A	F2
C 1120	AL.ELECTRO.CAP.	47uF	16V		EEE1CA470WR	K48120025		1-	A	B3
C 1121	CHIP CAP.	0.1uF	16V	B	GRM188B11C104KA01D	K22124805		1-	A	B2
C 1122	AL.ELECTRO.CAP.	47uF	16V		EEE1CA470SP	K48120005		1-	A	C4
C 1123	CHIP CAP.	47pF	50V	CH	GRM1882C1H470JA01D	K22174227		1-	A	F1
C 1124	CHIP CAP.	0.01uF	50V	B	GRM188B11H103KA01D	K22174823		1-	A	C2
C 1125	AL.ELECTRO.CAP.	47uF	16V		EEE1CA470SP	K48120005		1-	A	C4
C 1126	CHIP CAP.	82pF	50V	CH	GRM1882C1H820JA01D	K22174233		1-	A	G1
C 1127	CHIP CAP.	0.01uF	50V	B	GRM188B11H103KA01D	K22174823		1-	A	G2
C 1128	CHIP CAP.	0.01uF	50V	B	GRM188B11H103KA01D	K22174823		1-	A	G1
C 1129	CHIP CAP.	0.01uF	50V	B	GRM188B11H103KA01D	K22174823		1-	A	H1
C 1130	CHIP CAP.	0.01uF	50V	B	GRM188B11H103KA01D	K22174823		1-	A	H1
C 1131	CHIP CAP.	0.01uF	50V	B	GRM188B11H103KA01D	K22174823		1-	A	F3
C 1132	CHIP CAP.	0.1uF	16V	B	GRM188B11C104KA01D	K22124805		1-	A	C2
C 1133	CHIP CAP.	0.01uF	50V	B	GRM188B11H103KA01D	K22174823		1-	A	H3
C 1134	CHIP CAP.	0.01uF	50V	B	GRM188B11H103KA01D	K22174823		1-	A	G2
C 1135	CHIP CAP.	39pF	50V	CH	GRM1882C1H390JA01D	K22174225		1-	A	G1
C 1136	CHIP CAP.	0.1uF	16V	B	GRM188B11C104KA01D	K22124805		1-	A	C4
C 1137	CHIP CAP.	100pF	50V	CH	GRM1882C1H101JA01D	K22174235		1-	A	F4
C 1138	CHIP CAP.	0.01uF	50V	B	GRM188B11H103KA01D	K22174823		1-	A	F1
C 1139	CHIP CAP.	0.01uF	50V	B	GRM188B11H103KA01D	K22174823		1-	A	G1
C 1140	CHIP CAP.	82pF	50V	CH	GRM1882C1H820JA01D	K22174233		1-	A	G2
C 1141	CHIP CAP.	82pF	50V	CH	GRM1882C1H820JA01D	K22174233		1-	A	G1
C 1142	CHIP CAP.	0.001uF	25V	CH	GRM1882C1E102JA01D	K22144204		1-	A	F2

MAIN Unit

Parts List

REF	DESCRIPTION	VALUE	V/W	TOL.	MFR'S DESIG	VXSTD P/N	VERS.	LOT	SIDE	LAY ADR
C 1143	CHIP CAP.	180pF	50V	CH	GRM1882C1H181JA01D	K22174241		1-	A	G1
C 1144	CHIP CAP.	0.001uF	25V	CH	GRM1882C1E102JA01D	K22144204		1-	A	H1
C 1145	CHIP CAP.	150pF	50V	CH	GRM1882C1H151JA01D	K22174239		1-	A	G2
C 1146	CHIP CAP.	0.0056uF	50V	B	GRM188B11H562KA01D	K22174818		1-	A	G2
C 1147	CHIP CAP.	180pF	50V	CH	GRM1882C1H181JA01D	K22174241		1-	A	G1
C 1148	CHIP CAP.	100pF	50V	CH	GRM1882C1H101JA01D	K22174235		1-	A	D4
C 1149	CHIP CAP.	0.0018uF	50V	B	GRM188B11H182KA01D	K22174812		1-	A	H1
C 1150	CHIP CAP.	100pF	50V	CH	GRM1882C1H101JA01D	K22174235		1-	A	D4
C 1151	CHIP CAP.	430pF	50V	CH	GRM1882C1H431JA01D	K22174256		1-	A	H1
C 1152	CHIP CAP.	0.0056uF	50V	B	GRM188B11H562KA01D	K22174818		1-	A	G2
C 1153	CHIP CAP.	39pF	50V	CH	GRM1882C1H390JA01D	K22174225		1-	A	G2
C 1154	CHIP CAP.	82pF	50V	CH	GRM1882C1H820JA01D	K22174233		1-	A	G1
C 1155	CHIP CAP.	180pF	50V	CH	GRM1882C1H181JA01D	K22174241		1-	A	G1
C 1156	CHIP CAP.	0.0056uF	50V	B	GRM188B11H562KA01D	K22174818		1-	A	H1
C 1157	CHIP CAP.	0.01uF	50V	B	GRM188B11H103KA01D	K22174823		1-	A	F5
C 1158	CHIP CAP.	0.001uF	25V	CH	GRM1882C1E102JA01D	K22144204		1-	A	F2
C 1159	CHIP CAP.	82pF	50V	CH	GRM1882C1H820JA01D	K22174233		1-	A	G1
C 1160	CHIP CAP.	0.001uF	25V	CH	GRM1882C1E102JA01D	K22144204		1-	A	H1
C 1161	CHIP CAP.	150pF	50V	CH	GRM1882C1H151JA01D	K22174239		1-	A	G2
C 1162	CHIP CAP.	39pF	50V	CH	GRM1882C1H390JA01D	K22174225		1-	A	D3
C 1163	CHIP CAP.	0.1uF	16V	B	GRM188B11C104KA01D	K22124805		1-	A	D3
C 1164	CHIP CAP.	8pF	50V	CH	GRM1882C1H8R0DZ01D	K22174209		1-	A	D3
C 1165	CHIP CAP.	180pF	50V	CH	GRM1882C1H181JA01D	K22174241		1-	A	G1
C 1166	CHIP CAP.	0.0018uF	50V	B	GRM188B11H182KA01D	K22174812		1-	A	H1
C 1167	CHIP TA.CAP.	1uF	35V		TEMSVA1V105M-8R	K78160032		1-	A	B3
C 1168	CHIP TA.CAP.	1uF	35V		TEMSVA1V105M-8R	K78160032		1-	A	B3
C 1169	CHIP CAP.	47pF	50V	CH	GRM1882C1H470JA01D	K22174227		1-	A	F1
C 1170	CHIP CAP.	6pF	50V	CH	GRM1882C1H6R0DZ01D	K22174207		1-	A	F1
C 1171	CHIP CAP.	0.01uF	50V	B	GRM188B11H103KA01D	K22174823		1-	A	D3
C 1172	CHIP CAP.	82pF	50V	CH	GRM1882C1H820JA01D	K22174233		1-	A	D3
C 1174	CHIP CAP.	82pF	50V	CH	GRM1882C1H820JA01D	K22174233		1-	A	F1
C 1175	CHIP CAP.	18pF	50V	CH	GRM1882C1H180JA01D	K22174217		1-	A	F1
C 1176	CHIP CAP.	0.001uF	50V	B	GRM188B11H102KA01D	K22174821		1-	A	D3
C 1177	CHIP CAP.	39pF	50V	CH	GRM1882C1H390JA01D	K22174225		1-	A	D3
C 1178	CHIP CAP.	68pF	50V	CH	GRM1882C1H680JA01D	K22174231		1-	A	F1
C 1179	CHIP CAP.	27pF	50V	CH	GRM1882C1H270JA01D	K22174221		1-	A	F1
C 1180	CHIP CAP.	47pF	50V	CH	GRM1882C1H470JA01D	K22174227		1-	A	D4
C 1181	CHIP TA.CAP.	10uF	16V		TEESVA1C106M8R	K78120077		1-	A	B4
C 1182	CHIP CAP.	47pF	50V	CH	GRM1882C1H470JA01D	K22174227		1-	A	D4
C 1183	AL.ELECTRO.CAP.	22uF	16V		EEE1CA220SR	K48120024		1-	A	C4
C 1184	CHIP CAP.	27pF	50V	CH	GRM1882C1H270JA01D	K22174221		1-	A	F1
C 1185	CHIP CAP.	15pF	50V	CH	GRM1882C1H150JA01D	K22174215		1-	A	D3
C 1186	CHIP CAP.	0.01uF	50V	B	GRM188B11H103KA01D	K22174823		1-	A	D3
C 1187	AL.ELECTRO.CAP.	220uF	10V		RV3-10V221MF80-R	K48100002		1-	A	C3
C 1188	CHIP CAP.	0.001uF	50V	B	GRM188B11H102KA01D	K22174821		1-	A	D6
C 1189	CHIP TA.CAP.	1uF	35V		TEMSVA1V105M-8R	K78160032		1-	A	B5
C 1190	CHIP TA.CAP.	10uF	16V		TEMSVB21C106M-8R	K78120025		1-	A	D3
C 1191	CHIP CAP.	0.01uF	50V	B	GRM188B11H103KA01D	K22174823		1-	A	D3
C 1192	CHIP CAP.	0.0022uF	50V	B	GRM188B11H222KA01D	K22174822		1-	A	C4
C 1193	CHIP CAP.	47pF	50V	CH	GRM1882C1H470JA01D	K22174227		1-	A	D4
C 1194	CHIP TA.CAP.	1uF	35V		TEMSVA1V105M-8R	K78160032		1-	A	C3
C 1195	CHIP CAP.	0.001uF	50V	B	GRM188B11H102KA01D	K22174821		1-	A	D3
C 1196	CHIP CAP.	0.0047uF	50V	B	GRM188B11H472KA01D	K22174833		1-	A	C4
C 1197	CHIP CAP.	0.01uF	50V	B	GRM188B11H103KA01D	K22174823		1-	A	D3
C 1198	CHIP CAP.	0.1uF	16V	B	GRM188B11C104KA01D	K22124805		1-	A	D4
C 1199	CHIP CAP.	0.01uF	50V	B	GRM188B11H103KA01D	K22174823		1-	A	D6
C 1200	CHIP TA.CAP.	10uF	16V		TEMSVB21C106M-8R	K78120025		1-	A	D4
C 1201	CHIP CAP.	220pF	50V	CH	GRM1882C1H221JA01D	K22174243		1-	A	D4
C 1202	AL.ELECTRO.CAP.	220uF	16V		MVA16VC220MF80	K48120021		1-	A	B3
C 1203	CHIP CAP.	10pF	50V	CH	GRM1882C1H100JA01D	K22174211		1-	A	D3
C 1204	AL.ELECTRO.CAP.	47uF	16V		EEE1CA470WR	K48120025		1-	A	C2
C 1205	CHIP CAP.	0.01uF	50V	B	GRM188B11H103JA01D	K22174824		1-	A	F1
C 1206	CHIP CAP.	0.047uF	16V	B	GRM39B473K16PT	K22124804		1-	A	B5
C 1207	CHIP TA.CAP.	1uF	35V		TEMSVA1V105M-8R	K78160032		1-	A	C3
C 1208	CHIP CAP.	47pF	50V	CH	GRM1882C1H470JA01D	K22174227		1-	A	D4
C 1209	CHIP CAP.	0.001uF	50V	B	GRM188B11H102KA01D	K22174821		1-	A	C3
C 1210	CHIP CAP.	0.01uF	50V	B	GRM188B11H103KA01D	K22174823		1-	A	D3
C 1211	CHIP CAP.	0.1uF	16V	B	GRM188B11C104KA01D	K22124805		1-	A	E1
C 1212	CHIP CAP.	0.001uF	50V	B	GRM188B11H102KA01D	K22174821		1-	A	E1
C 1213	CHIP CAP.	0.1uF	16V	B	GRM188B11C104KA01D	K22124805		1-	A	E1
C 1214	CHIP CAP.	0.001uF	50V	B	GRM188B11H102KA01D	K22174821		1-	A	E1
C 1215	CHIP CAP.	18pF	50V	CH	GRM1882C1H180JA01D	K22174217		1-	A	D3
C 1216	CHIP CAP.	0.01uF	50V	B	GRM188B11H103KA01D	K22174823		1-	A	D3

MAIN Unit

Parts List

REF	DESCRIPTION	VALUE	V/W	TOL.	MFR'S DESIG	VXSTD P/N	VERS.	LOT	SIDE	LAY ADR
C 1217	CHIP CAP.	0.1uF	16V	B	GRM188B11C104KA01D	K22124805		1-	A	B5
C 1218	CHIP CAP.	0.022uF	50V	B	GRM40B223M50PT	K22170821		1-	A	D5
C 1219	CHIP CAP.	0.1uF	16V	B	GRM188B11C104KA01D	K22124805		1-	A	E1
C 1220	CHIP CAP.	0.1uF	16V	B	GRM188B11C104KA01D	K22124805		1-	A	E1
C 1221	CHIP CAP.	0.001uF	50V	B	GRM188B11H102KA01D	K22174821		1-	A	C3
C 1222	CHIP TA.CAP.	1uF	35V		TEMSVA1V105M-8R	K78160032		1-	A	C2
C 1223	CHIP CAP.	56pF	50V	CH	GRM1882C1H560JA01D	K22174229		1-	A	D5
C 1224	CHIP CAP.	0.01uF	50V	B	GRM188B11H103KA01D	K22174823		1-	A	C3
C 1225	CHIP CAP.	0.001uF	50V	B	GRM188B11H102KA01D	K22174821		1-	A	E1
C 1226	CHIP CAP.	0.001uF	50V	B	GRM188B11H102KA01D	K22174821		1-	A	E2
C 1227	CHIP CAP.	0.001uF	50V	B	GRM188B11H102KA01D	K22174821		1-	A	E1
C 1228	CHIP CAP.	0.001uF	50V	B	GRM188B11H102KA01D	K22174821		1-	A	E2
C 1229	CHIP CAP.	0.1uF	16V	B	GRM188B11C104KA01D	K22124805		1-	A	E1
C 1230	CHIP CAP.	0.1uF	16V	B	GRM188B11C104KA01D	K22124805		1-	A	E1
C 1231	CHIP CAP.	0.01uF	50V	B	GRM188B11H103KA01D	K22174823		1-	A	D3
C 1232	CHIP CAP.	10pF	50V	CH	GRM1882C1H100JA01D	K22174211		1-	A	D3
C 1233	CHIP CAP.	0.001uF	50V	B	GRM188B11H102KA01D	K22174821		1-	A	C2
C 1234	CHIP TA.CAP.	1uF	35V		TEMSVA1V105M-8R	K78160032		1-	A	C3
C 1235	CHIP TA.CAP.	1uF	35V		TEMSVA1V105M-8R	K78160032		1-	A	C3
C 1236	CHIP CAP.	0.01uF	50V	B	GRM188B11H103KA01D	K22174823		1-	A	C2
C 1237	CHIP CAP.	0.1uF	16V	B	GRM188B11C104KA01D	K22124805		1-	A	E1
C 1238	CHIP CAP.	0.1uF	16V	B	GRM188B11C104KA01D	K22124805		1-	A	E2
C 1239	CHIP CAP.	15pF	50V	CH	GRM1882C1H150JA01D	K22174215		1-	A	D3
C 1240	CHIP TA.CAP.	1uF	35V		TEMSVA1V105M-8R	K78160032		1-	A	D4
C 1241	CHIP CAP.	0.01uF	50V	B	GRM188B11H103KA01D	K22174823		1-	A	C2
C 1242	CHIP CAP.	0.1uF	16V	B	GRM188B11C104KA01D	K22124805		1-	A	E1
C 1243	CHIP CAP.	0.1uF	16V	B	GRM188B11C104KA01D	K22124805		1-	A	E2
C 1244	CHIP TA.CAP.	10uF	16V		TEESVA1C106M8R	K78120077		1-	A	D5
C 1245	CHIP CAP.	0.047uF	16V	B	GRM39B473K16PT	K22124804		1-	A	B5
C 1246	CHIP CAP.	0.001uF	50V	B	GRM188B11H102KA01D	K22174821		1-	A	C2
C 1247	CHIP TA.CAP.	0.22uF	35V		TESVA1V224M1-8R	K78160027		1-	A	D3
C 1248	CHIP TA.CAP.	10uF	16V		TEESVA1C106M8R	K78120077		1-	A	D5
C 1249	CHIP CAP.	0.0022uF	50V	B	GRM188B11H222KA01D	K22174822		1-	A	E6
C 1250	CHIP CAP.	0.01uF	50V	B	GRM188B11H103KA01D	K22174823		1-	A	D4
C 1251	CHIP CAP.	0.1uF	16V	B	GRM188B11C104KA01D	K22124805		1-	A	C5
C 1252	CHIP CAP.	0.1uF	16V	B	GRM188B11C104KA01D	K22124805		1-	A	C3
C 1253	CHIP TA.CAP.	0.47uF	35V		TEMSVA1V474M-8R	K78160029		1-	A	C3
C 1254	CHIP TA.CAP.	10uF	16V		TEMSVB21C106M-8R	K78120025		1-	A	C3
C 1255	CHIP CAP.	22pF	50V	CH	GRM1882C1H220JA01D	K22174219		1-	A	C5
C 1256	CHIP CAP.	0.01uF	50V	B	GRM188B11H103KA01D	K22174823		1-	A	D3
C 1257	CHIP TA.CAP.	10uF	16V		TEESVA1C106M8R	K78120077		1-	A	E5
C 1258	CHIP CAP.	0.0022uF	50V	B	GRM188B11H222KA01D	K22174822		1-	A	E6
C 1259	CHIP CAP.	100pF	50V	CH	GRM1882C1H101JA01D	K22174235		1-	A	D5
C 1260	CHIP CAP.	330pF	50V	CH	GRM1882C1H331JA01D	K22174253		1-	A	D5
C 1261	CHIP CAP.	330pF	50V	CH	GRM1882C1H331JA01D	K22174253		1-	A	D5
C 1262	AL.ELECTRO.CAP.	220uF	10V		RV3-10V221MF80-R	K48100002		1-	A	B5
C 1263	CHIP CAP.	0.001uF	50V	B	GRM188B11H102KA01D	K22174821		1-	A	D3
C 1264	CHIP CAP.	150pF	50V	CH	GRM1882C1H151JA01D	K22174239		1-	A	E2
C 1265	CHIP CAP.	0.01uF	50V	B	GRM188B11H103KA01D	K22174823		1-	A	E1
C 1266	CHIP CAP.	0.1uF	16V	B	GRM188B11C104KA01D	K22124805		1-	A	E5
C 1267	AL.ELECTRO.CAP.	220uF	10V		RV3-10V221MF80-R	K48100002		1-	A	C2
C 1268	CHIP CAP.	120pF	50V	CH	GRM1882C1H121JA01D	K22174237		1-	A	E2
C 1269	CHIP CAP.	0.01uF	50V	B	GRM188B11H103KA01D	K22174823		1-	A	C2
C 1270	CHIP CAP.	0.01uF	50V	B	GRM188B11H103JA01D	K22174824		1-	A	F2
C 1271	CHIP CAP.	0.01uF	50V	B	GRM188B11H103KA01D	K22174823		1-	A	B2
C 1272	CHIP CAP.	0.01uF	50V	B	GRM188B11H103JA01D	K22174824		1-	A	E1
C 1273	CHIP CAP.	0.0022uF	50V	B	GRM188B11H222KA01D	K22174822		1-	A	E6
C 1274	CHIP CAP.	0.022uF	25V	B	GRM39B223K25PT	K22144807		1-	A	D5
C 1275	CHIP CAP.	0.01uF	50V	B	GRM188B11H103KA01D	K22174823		1-	A	B2
C 1276	CHIP CAP.	0.01uF	50V	B	GRM188B11H103KA01D	K22174823		1-	A	E3
C 1277	CHIP CAP.	0.1uF	16V	B	GRM188B11C104KA01D	K22124805		1-	A	E6
C 1278	CHIP CAP.	0.01uF	50V	B	GRM188B11H103KA01D	K22174823		1-	A	D3
C 1279	CHIP TA.CAP.	1uF	35V		TEMSVA1V105M-8R	K78160032		1-	A	C5
C 1280	CHIP CAP.	2pF	50V	CK	GRM1884C1H2R0CZ01D	K22174203		1-	A	E2
C 1281	CHIP CAP.	0.01uF	25V	B	GRM39B103K25PT	K22144803		1-	A	D5
C 1282	CHIP CAP.	15pF	50V	CH	GRM1882C1H150JA01D	K22174215		1-	A	D3
C 1283	CHIP CAP.	2pF	50V	CK	GRM1884C1H2R0CZ01D	K22174203		1-	A	D2
C 1284	CHIP TA.CAP.	1uF	35V		TEMSVA1V105M-8R	K78160032		1-	A	B6
C 1286	CHIP CAP.	27pF	50V	CH	GRM1882C1H270JA01D	K22174221		1-	A	D2
C 1287	CHIP TA.CAP.	1uF	35V		TEMSVA1V105M-8R	K78160032		1-	A	B6
C 1288	CHIP CAP.	0.1uF	16V	B	GRM188B11C104KA01D	K22124805		1-	A	E2
C 1289	CHIP CAP.	0.001uF	50V	B	GRM188B11H102KA01D	K22174821		1-	A	E2
C 1290	CHIP CAP.	0.001uF	50V	B	GRM188B11H102KA01D	K22174821		1-	A	E2

MAIN Unit

Parts List

REF	DESCRIPTION	VALUE	V/W	TOL.	MFR'S DESIG	VXSTD P/N	VERS.	LOT	SIDE	LAY ADR
C 1291	CHIP CAP.	0.1uF	16V	B	GRM188B11C104KA01D	K22124805		1-	A	E2
C 1292	CHIP CAP.	330pF	50V	CH	GRM1882C1H331JA01D	K22174253		1-	A	E6
C 1294	CHIP CAP.	56pF	50V	CH	GRM1882C1H560JA01D	K22174229		1-	A	D2
C 1295	CHIP TA.CAP.	1uF	35V		TEMSVA1V105M-8R	K78160032		1-	A	E5
C 1296	CHIP CAP.	0.01uF	50V	B	GRM188B11H103KA01D	K22174823		1-	A	D4
C 1297	CHIP TA.CAP.	1uF	35V		TEMSVA1V105M-8R	K78160032		1-	A	B6
C 1298	CHIP CAP.	0.1uF	16V	B	GRM188B11C104KA01D	K22124805		1-	A	E5
C 1299	CHIP CAP.	27pF	50V	CH	GRM1882C1H270JA01D	K22174221		1-	A	D2
C 1300	CHIP CAP.	10pF	50V	CH	GRM1882C1H100JA01D	K22174211		1-	A	E2
C 1301	CHIP CAP.	0.01uF	25V	B	GRM39B103K25PT	K22144803		1-	A	E6
C 1302	CHIP CAP.	0.1uF	16V	B	GRM188B11C104KA01D	K22124805		1-	A	E5
C 1303	CHIP CAP.	0.01uF	50V	B	GRM188B11H103JA01D	K22174824		1-	A	F2
C 1304	CHIP TA.CAP.	1uF	35V		TEMSVA1V105M-8R	K78160032		1-	A	E1
C 1305	CHIP TA.CAP.	1uF	35V		TEMSVA1V105M-8R	K78160032		1-	A	C6
C 1306	CHIP TA.CAP.	1uF	35V		TEMSVA1V105M-8R	K78160032		1-	A	C5
C 1307	CHIP CAP.	0.01uF	50V	B	GRM188B11H103KA01D	K22174823		1-	A	E2
C 1308	CHIP CAP.	27pF	50V	CH	GRM1882C1H270JA01D	K22174221		1-	A	E5
C 1309	CHIP CAP.	0.1uF	16V	B	GRM188B11C104KA01D	K22124805		1-	A	E5
C 1310	CHIP CAP.	0.01uF	50V	B	GRM188B11H103KA01D	K22174823		1-	A	E4
C 1311	CHIP CAP.	12pF	50V	CH	GRM1882C1H120JA01D	K22174213		1-	A	D4
C 1312	CHIP CAP.	0.01uF	50V	B	GRM188B11H103JA01D	K22174824		1-5	A	F2
C 1313	CHIP CAP.	100pF	50V	CH	GRM1882C1H101JA01D	K22174235		1-	A	E5
C 1314	CHIP CAP.	56pF	50V	CH	GRM1882C1H560JA01D	K22174229		1-	A	E4
C 1315	CHIP CAP.	470pF	50V	CH	GRM1882C1H471JA01D	K22174249		1-	A	E1
C 1316	CHIP CAP.	0.001uF	50V	B	GRM188B11H102KA01D	K22174821		1-	A	E3
C 1317	CHIP CAP.	0.01uF	50V	B	GRM188B11H103JA01D	K22174824		1-	A	E3
C 1318	CHIP CAP.	0.001uF	50V	B	GRM188B11H102KA01D	K22174821		1-	A	E3
C 1319	CHIP CAP.	0.1uF	16V	B	GRM188B11C104KA01D	K22124805		1-	A	F6
C 1320	CHIP CAP.	0.1uF	16V	B	GRM188B11C104KA01D	K22124805		1-	A	E5
C 1321	CHIP TA.CAP.	10uF	16V		TEESVA1C106M8R	K78120077		1-	A	D4
C 1322	CHIP CAP.	0.1uF	16V	B	GRM188B11C104KA01D	K22124805		1-	A	E2
C 1323	CHIP TA.CAP.	1uF	35V		TEMSVA1V105M-8R	K78160032		1-	A	C6
C 1324	CHIP TA.CAP.	1uF	35V		TEMSVA1V105M-8R	K78160032		1-	A	C5
C 1325	CHIP CAP.	0.1uF	16V	B	GRM188B11C104KA01D	K22124805		1-	A	F5
C 1326	CHIP CAP.	82pF	50V	CH	GRM1882C1H820JA01D	K22174233		1-	A	E6
C 1327	CHIP TA.CAP.	10uF	16V		TEESVA1C106M8R	K78120077		1-	A	E5
C 1328	CHIP TA.CAP.	10uF	10V		TEMSVB21A106M-8R	K78100017		1-	A	E2
C 1329	CHIP CAP.	6pF	50V	CH	GRM1882C1H6R0DZ01D	K22174207		1-	A	E4
C 1330	CHIP CAP.	0.01uF	50V	B	GRM188B11H103KA01D	K22174823		1-	A	D4
C 1331	CHIP CAP.	0.01uF	50V	B	GRM188B11H103KA01D	K22174823		1-	A	E1
C 1332	CHIP TA.CAP.	10uF	16V		TEESVA1C106M8R	K78120077		1-5	A	E1
C 1333	CHIP TA.CAP.	10uF	16V		TEESVA1C106M8R	K78120077		1-	A	F5
C 1334	CHIP CAP.	10pF	50V	CH	GRM1882C1H100JA01D	K22174211		1-	A	E3
C 1335	CHIP CAP.	0.01uF	50V	B	GRM188B11H103KA01D	K22174823		1-	A	E1
C 1336	CHIP TA.CAP.	10uF	16V		TEESVA1C106M8R	K78120077		1-	A	E1
C 1337	CHIP TA.CAP.	10uF	16V		TEESVA1C106M8R	K78120077		1-	A	E4
C 1338	CHIP CAP.	0.1uF	16V	B	GRM188B11C104KA01D	K22124805		1-	A	F5
C 1339	CHIP TA.CAP.	1uF	35V		TEMSVA1V105M-8R	K78160032		1-	A	C5
C 1340	CHIP TA.CAP.	1uF	35V		TEMSVA1V105M-8R	K78160032		1-	A	D5
C 1341	CHIP CAP.	220pF	50V	CH	GRM1882C1H221JA01D	K22174243		1-	A	B5
C 1342	AL.ELECTRO.CAP.	10uF	16V		RV4-16V100MD46-RR2	K48120018		1-	A	F3
C 1343	CHIP TA.CAP.	10uF	16V		TEESVA1C106M8R	K78120077		1-	A	E4
C 1344	CHIP CAP.	0.001uF	50V	B	GRM188B11H102KA01D	K22174821		1-	A	E4
C 1345	CHIP TA.CAP.	1uF	35V		TEMSVA1V105M-8R	K78160032		1-	A	D6
C 1346	CHIP CAP.	0.1uF	16V	B	GRM188B11C104KA01D	K22124805		1-	A	E4
C 1347	CHIP CAP.	330pF	50V	CH	GRM1882C1H331JA01D	K22174253		1-	A	C5
C 1348	CHIP CAP.	82pF	50V	CH	GRM1882C1H820JA01D	K22174233		1-	A	E5
C 1350	CHIP CAP.	0.01uF	25V	B	GRM39B103K25PT	K22144803		1-	A	F6
C 1351	CHIP CAP.	0.1uF	16V	B	GRM188B11C104KA01D	K22124805		1-	A	F3
C 1352	CHIP CAP.	0.1uF	16V	B	GRM188B11C104KA01D	K22124805		1-	A	E4
C 1353	AL.ELECTRO.CAP.	47uF	16V		EEE1CA470WR	K48120025		1-	A	A5
C 1354	CHIP CAP.	330pF	50V	CH	GRM1882C1H331JA01D	K22174253		1-	A	D5
C 1355	CHIP CAP.	220pF	50V	CH	GRM1882C1H221JA01D	K22174243		1-	A	B5
C 1357	CHIP CAP.	43pF	50V	CH	GRM1882C1H430JZ01D	K22174226		1-	A	E3
C 1358	CHIP CAP.	100pF	50V	CH	GRM1882C1H101JA01D	K22174235		1-	A	F5
C 1359	CHIP CAP.	0.1uF	16V	B	GRM188B11C104KA01D	K22124805		1-	A	G6
C 1360	CHIP TA.CAP.	10uF	16V		TEESVA1C106M8R	K78120077		1-	A	G5
C 1361	CHIP CAP.	0.001uF	50V	B	GRM188B11H102KA01D	K22174821		1-	A	E4
C 1362	CHIP TA.CAP.	1uF	35V		TEMSVA1V105M-8R	K78160032		1-	A	F6
C 1363	CHIP CAP.	0.01uF	50V	B	GRM188B11H103JA01D	K22174824		1-	A	D2
C 1365	CHIP CAP.	0.047uF	50V	B	GRM40B473M50PT	K22170823		1-	A	E4
C 1366	CHIP CAP.	0.1uF	16V	B	GRM188B11C104KA01D	K22124805		1-	A	F5
C 1367	CHIP TA.CAP.	1uF	35V		TEMSVA1V105M-8R	K78160032		1-	A	F6

MAIN Unit

Parts List

REF	DESCRIPTION	VALUE	V/W	TOL.	MFR'S DESIG	VXSTD P/N	VERS.	LOT	SIDE	LAY ADR
C 1368	CHIP CAP.	82pF	50V	CH	GRM1882C1H820JA01D	K22174233		1-	A	F5
C 1369	CHIP CAP.	0.047uF	16V	B	GRM39B473K16PT	K22124804		1-	A	A5
C 1370	CHIP CAP.	0.33uF	16V	B	GRM40B334K16PT	K22120807		1-	A	B5
C 1371	CHIP CAP.	0.1uF	16V	B	GRM188B11C104KA01D	K22124805		1-	A	D5
C 1372	CHIP CAP.	0.33uF	16V	B	GRM40B334K16PT	K22120807		1-	A	A5
C 1373	CHIP TA.CAP.	1uF	35V		TEMSVA1V105M-8R	K78160032		1-	A	A5
C 1374	CHIP CAP.	330pF	50V	CH	GRM1882C1H331JA01D	K22174253		1-	A	D1
C 1375	CHIP CAP.	0.01uF	50V	B	GRM188B11H103KA01D	K22174823		1-	A	E3
C 1377	CHIP CAP.	12pF	50V	CH	GRM1882C1H120JA01D	K22174213		1-	A	E4
C 1378	CHIP CAP.	180pF	50V	CH	GRM1882C1H181JA01D	K22174241		1-	A	D5
C 1379	CHIP CAP.	0.001uF	50V	B	GRM188B11H102KA01D	K22174821		1-	A	A5
C 1380	CHIP CAP.	0.1uF	16V	B	GRM188B11C104KA01D	K22124805		1-	A	F5
C 1381	CHIP CAP.	82pF	50V	CH	GRM1882C1H820JA01D	K22174233		1-	A	E4
C 1382	AL.ELECTRO.CAP.	100uF	10V		RVZ-10V101MF55U-R2	K48100008		1-	A	A5
C 1383	CHIP TA.CAP.	1uF	35V		TEMSVA1V105M-8R	K78160032		1-	A	B5
C 1384	CHIP CAP.	0.01uF	50V	B	GRM188B11H103KA01D	K22174823		1-	A	F5
C 1385	CHIP CAP.	0.1uF	16V	B	GRM188B11C104KA01D	K22124805		1-	A	D5
C 1386	CHIP CAP.	0.01uF	50V	B	GRM188B11H103KA01D	K22174823		1-	A	E4
C 1387	AL.ELECTRO.CAP.	1000uF	16V		RE3-16V102MH3#	K40129096		1-	A	A4
C 1388	AL.ELECTRO.CAP.	220uF	10V		RV3-10V221MF80-R	K48100002		1-	A	A5
C 1389	CHIP CAP.	0.01uF	50V	B	GRM188B11H103KA01D	K22174823		1-	A	F6
C 1390	CHIP CAP.	0.001uF	50V	B	GRM188B11H102KA01D	K22174821		1-	A	D1
C 1391	CHIP CAP.	0.01uF	25V	B	GRM39B103K25PT	K22144803		1-	A	F5
C 1392	CHIP CAP.	0.001uF	50V	B	GRM188B11H102KA01D	K22174809		1-	A	F5
C 1393	AL.ELECTRO.CAP.	220uF	10V		RV3-10V221MF80-R	K48100002		1-	A	A5
C 1394	CHIP TA.CAP.	10uF	16V		TEESVA1C106M8R	K78120077		1-	A	F5
C 1395	AL.ELECTRO.CAP.	220uF	10V		RV3-10V221MF80-R	K48100002		1-	A	B5
C 1396	CHIP TA.CAP.	10uF	16V		TEESVA1C106M8R	K78120077		1-	A	B5
C 1397	CHIP CAP.	0.01uF	50V	B	GRM188B11H103KA01D	K22174823		1-	A	F5
C 1398	CHIP CAP.	82pF	50V	CH	GRM1882C1H820JA01D	K22174233		1-	A	D4
C 1399	CHIP CAP.	0.01uF	50V	B	GRM188B11H103KA01D	K22174823		1-	A	F6
C 1400	CHIP CAP.	0.0022uF	50V	B	GRM188B11H222KA01D	K22174822		1-	A	C5
C 1401	AL.ELECTRO.CAP.	1000uF	16V		RE3-16V102MH3#	K40129096		1-	A	A4
C 1402	CHIP TA.CAP.	1uF	35V		TEMSVA1V105M-8R	K78160032		1-	A	D6
C 1403	CHIP CAP.	56pF	50V	CH	GRM1882C1H560JA01D	K22174229		1-	A	F3
C 1404	CHIP CAP.	0.01uF	50V	B	GRM188B11H103KA01D	K22174823		1-	A	D5
C 1405	CHIP CAP.	0.0047uF	50V	B	GRM188B11H472KA01D	K22174817		1-	A	C5
C 1406	AL.ELECTRO.CAP.	470uF	16V		RE3-16V471MG3#	K40129066		1-	A	A5
C 1407	CHIP CAP.	15pF	50V	CH	GRM1882C1H150JA01D	K22174215		1-	A	F3
C 1408	CHIP CAP.	0.001uF	50V	B	GRM188B11H102KA01D	K22174821		1-	A	D1
C 1409	CHIP CAP.	0.001uF	50V	B	GRM188B11H102KA01D	K22174821		1-	A	D1
C 1410	CHIP CAP.	0.01uF	50V	B	GRM188B11H103KA01D	K22174823		1-	A	F5
C 1411	CHIP CAP.	0.1uF	16V	B	GRM188B11C104KA01D	K22124805		1-	A	F5
C 1412	CHIP CAP.	0.1uF	16V	B	GRM188B11C104KA01D	K22124805		1-	A	G6
C 1413	CHIP TA.CAP.	10uF	16V		TEESVA1C106M8R	K78120077		1-	A	D4
C 1414	CHIP CAP.	0.01uF	50V	B	GRM188B11H103KA01D	K22174823		1-	A	E6
C 1415	CHIP CAP.	0.047uF	50V	B	GRM40B473M50PT	K22170823		1-	A	D4
C 1416	CHIP CAP.	0.1uF	16V	B	GRM188B11C104KA01D	K22124805		1-	A	C4
C 1417	CHIP CAP.	47pF	50V	CH	GRM1882C1H470JA01D	K22174227		1-	A	D1
C 1418	CHIP CAP.	0.01uF	50V	B	GRM188B11H103KA01D	K22174823		1-	A	E4
C 1419	CHIP CAP.	0.1uF	16V	B	GRM188B11C104KA01D	K22124805		1-	A	D4
C 1420	AL.ELECTRO.CAP.	220uF	16V		MVA16VC220MF80	K48120021		1-	A	A5
C 1421	CHIP CAP.	0.01uF	50V	B	GRM188B11H103KA01D	K22174823		1-	A	E5
C 1422	CHIP CAP.	0.0015uF	50V	B	GRM188B11H152KA01D	K22174827		1-	A	D5
C 1423	CHIP TA.CAP.	10uF	16V		TEESVA1C106M8R	K78120077		1-	A	C4
C 1424	CHIP CAP.	5pF	50V	CH	GRM1882C1H5R0CZ01D	K22174206		1-	A	E4
C 1425	CHIP CAP.	0.01uF	50V	B	GRM188B11H103KA01D	K22174823		1-	A	F5
C 1426	CHIP CAP.	0.01uF	50V	B	GRM188B11H103KA01D	K22174823		1-	A	F5
C 1428	CHIP CAP.	68pF	50V	CH	GRM1882C1H680JA01D	K22174231		1-	A	F4
C 1429	CHIP CAP.	0.01uF	50V	B	GRM188B11H103KA01D	K22174823		1-	A	E6
C 1430	CHIP CAP.	56pF	50V	CH	GRM1882C1H560JA01D	K22174229		1-	A	F4
C 1431	CHIP CAP.	24pF	50V	CH	GRM1882C1H240JZ01D	K22174220		1-	A	D1
C 1432	CHIP CAP.	0.01uF	50V	B	GRM188B11H103KA01D	K22174823		1-	A	E4
C 1433	CHIP CAP.	0.01uF	50V	B	GRM188B11H103KA01D	K22174823		1-	A	D5
C 1434	CHIP CAP.	0.01uF	50V	B	GRM188B11H103KA01D	K22174823		1-	A	F5
C 1435	CHIP CAP.	0.01uF	50V	B	GRM188B11H103KA01D	K22174823		1-	A	B5
C 1436	CHIP CAP.	0.01uF	50V	B	GRM188B11H103KA01D	K22174823		1-	A	E6
C 1438	CHIP CAP.	47pF	50V	CH	GRM1882C1H470JA01D	K22174227		1-	A	D1
C 1439	CHIP TA.CAP.	10uF	16V		TEESVA1C106M8R	K78120077		1-	A	D4
C 1440	CHIP TA.CAP.	1uF	16V		TEMSVA21C105M-8R	K78120024		1-	A	D5
C 1441	CHIP CAP.	12pF	50V	CH	GRM1882C1H120JA01D	K22174213		1-	A	F4
C 1442	CHIP CAP.	0.01uF	50V	B	GRM188B11H103KA01D	K22174823		1-	A	F4
C 1443	CHIP CAP.	0.01uF	50V	B	GRM188B11H103KA01D	K22174823		1-	A	D6

MAIN Unit

Parts List

REF	DESCRIPTION	VALUE	V/W	TOL.	MFR'S DESIG	VXSTD P/N	VERS.	LOT	SIDE	LAY ADR
C 1444	CHIP CAP.	0.1uF	16V	B	GRM188B11C104KA01D	K22124805		1-	A	D4
C 1445	CHIP TA.CAP.	10uF	16V		TEESVA1C106M8R	K78120077		1-	A	C5
C 1446	CHIP TA.CAP.	1uF	35V		TEMSVA1V105M-8R	K78160032		1-	A	C4
C 1447	CHIP CAP.	0.001uF	50V	B	GRM188B11H102KA01D	K22174821		1-	A	E4
C 1448	CHIP CAP.	0.01uF	50V	B	GRM188B11H103KA01D	K22174823		1-	A	A6
C 1449	CHIP CAP.	0.01uF	50V	B	GRM188B11H103KA01D	K22174823		1-	A	A6
C 1450	CHIP CAP.	0.001uF	50V	B	GRM188B11H102KA01D	K22174821		1-	A	D5
C 1451	CHIP CAP.	0.01uF	50V	B	GRM188B11H103JA01D	K22174824		1-	A	F4
C 1452	CHIP CAP.	0.022uF	25V	B	GRM39B223K25PT	K22144807		1-	A	A5
C 1453	CHIP CAP.	0.01uF	50V	B	GRM188B11H103KA01D	K22174823		1-	A	F4
C 1454	CHIP TA.CAP.	1uF	35V		TEMSVA1V105M-8R	K78160032		1-	A	A6
C 1455	CHIP TA.CAP.	0.47uF	25V		TESVA1E474M1-8R	K78140009		1-	A	E4
C 1456	CHIP TA.CAP.	10uF	16V		TEESVA1C106M8R	K78120077		1-	A	F5
C 1457	CHIP TA.CAP.	1uF	35V		TEMSVA1V105M-8R	K78160032		1-	A	C4
C 1458	CHIP TA.CAP.	1uF	35V		TEMSVA1V105M-8R	K78160032		1-	A	C5
C 1459	CHIP TA.CAP.	10uF	16V		TEESVA1C106M8R	K78120077		1-	A	C5
C 1460	CHIP CAP.	0.022uF	25V	B	GRM39B223K25PT	K22144807		1-	A	A5
C 1461	CHIP CAP.	18pF	50V	CH	GRM1882C1H180JA01D	K22174217		1-	A	F4
C 1462	CHIP CAP.	0.01uF	50V	B	GRM188B11H103JA01D	K22174824		1-	A	F4
C 1463	CHIP CAP.	0.022uF	25V	B	GRM39B223K25PT	K22144807		1-	A	A5
C 1464	CHIP CAP.	0.01uF	50V	B	GRM188B11H103KA01D	K22174823		1-	A	D3
C 1465	CHIP TA.CAP.	1uF	35V		TEMSVA1V105M-8R	K78160032		1-	A	D4
C 1466	CHIP CAP.	0.1uF	16V	B	GRM188B11C104KA01D	K22124805		1-	A	C4
C 1467	CHIP CAP.	15pF	50V	CH	GRM1882C1H150JA01D	K22174215		1-	A	E3
C 1468	CHIP CAP.	0.01uF	50V	B	GRM188B11H103JA01D	K22174824		1-	A	E3
C 1469	CHIP CAP.	0.022uF	25V	B	GRM39B223K25PT	K22144807		1-	A	A5
C 1470	CHIP CAP.	0.1uF	16V	B	GRM188B11C104KA01D	K22124805		1-	A	A6
C 1471	CHIP CAP.	0.022uF	25V	B	GRM39B223K25PT	K22144807		1-	A	A5
C 1472	CHIP CAP.	0.01uF	50V	B	GRM188B11H103JA01D	K22174824		1-	A	F4
C 1473	CHIP CAP.	0.01uF	50V	B	GRM188B11H103KA01D	K22174823		1-	A	E6
C 1474	CHIP CAP.	0.01uF	50V	B	GRM188B11H103KA01D	K22174823		1-	A	H2
C 1475	CHIP CAP.	0.01uF	50V	B	GRM188B11H103KA01D	K22174823		1-	A	H2
C 1476	CHIP CAP.	0.1uF	16V	B	GRM188B11C104KA01D	K22124805		1-	A	C4
C 1477	CHIP TA.CAP.	10uF	16V		TEMSVB21C106M-8R	K78120025		1-	A	F5
C 1478	CHIP TA.CAP.	10uF	16V		TEMSVB21C106M-8R	K78120025		1-	A	G5
C 1479	CHIP CAP.	0.01uF	50V	B	GRM188B11H103KA01D	K22174823		1-	A	G5
C 1480	CHIP CAP.	0.1uF	16V	B	GRM188B11C104KA01D	K22124805		1-	A	B5
C 1481	CHIP CAP.	0.1uF	16V	B	GRM188B11C104KA01D	K22124805		1-	A	B5
C 1482	CHIP CAP.	0.001uF	50V	B	GRM188B11H102KA01D	K22174821		1-	A	B6
C 1483	CHIP CAP.	0.001uF	50V	B	GRM188B11H102KA01D	K22174821		1-	A	A6
C 1484	CHIP CAP.	0.001uF	50V	B	GRM188B11H102KA01D	K22174809		1-	A	A1
C 1485	CHIP CAP.	0.001uF	50V	B	GRM188B11H102KA01D	K22174809		1-	A	D2
C 1488	CHIP CAP.	0.001uF	50V	B	GRM188B11H102KA01D	K22174809		1-	A	D2
C 1489	CHIP CAP.	0.001uF	50V	B	GRM188B11H102KA01D	K22174809		1-	A	D3
C 1506	CHIP CAP.	0.001uF	25V	CH	GRM1882C1E102JA01D	K22144204		1-	A	H1
C 1508	CHIP CAP.	0.001uF	25V	CH	GRM1882C1E102JA01D	K22144204		1-	A	H1
C 1510	CHIP CAP.	560pF	25V	CH	GRM39CH561J25PT	K22144201		1-	A	H1
C 1513	CHIP CAP.	560pF	25V	CH	GRM39CH561J25PT	K22144201		1-	A	G2
C 1514	CHIP CAP.	560pF	25V	CH	GRM39CH561J25PT	K22144201		1-	A	G2
C 1516	CHIP CAP.	47pF	50V	CH	GRM1882C1H470JA01D	K22174227		1-	A	E2
C 1517	CHIP CAP.	27pF	50V	CH	GRM1882C1H270JA01D	K22174221		1-	A	E2
C 1518	CHIP CAP.	33pF	50V	CH	GRM1882C1H330JA01D	K22174223		1-	A	E2
C 1519	CHIP CAP.	100pF	50V	CH	GRM1882C1H101JA01D	K22174235		1-	A	E2
C 1520	CHIP CAP.	390pF	50V	CH	GRM1882C1H391JA01D	K22174255		1-	A	E2
C 1521	CHIP CAP.	150pF	50V	CH	GRM1882C1H151JA01D	K22174239		1-	A	E2
C 1522	CHIP CAP.	68pF	50V	CH	GRM1882C1H680JA01D	K22174231		1-	A	E2
C 1530	CHIP CAP.	0.047uF	50V	B	GRM40B473M50PT	K22170823		1-	A	D5
C 1531	CHIP CAP.	0.1uF	16V	B	GRM188B11C104KA01D	K22124805		1-	A	D2
C 1532	CHIP CAP.	0.1uF	16V	B	GRM188B11C104KA01D	K22124805		1-	A	D1
C 1533	CHIP CAP.	0.0068uF	50V	B	GRM188B11H682KA01D	K22174819		1-	A	D4
C 1534	CHIP CAP.	100pF	50V	CH	GRM1882C1H101JA01D	K22174235		1-	A	F5
C 1536	CHIP CAP.	3pF	50V	CJ	GRM1883C1H3R0CZ01D	K22174204		1-	A	F1
C 1543	CHIP CAP.	4pF	50V	CH	GRM1882C1H4R0CZ01D	K22174205		1-	A	F3
C 1544	CHIP CAP.	43pF	50V	CH	GRM1882C1H430JZ01D	K22174226		1-	A	E4
C 1545	CHIP CAP.	2pF	50V	CK	GRM1884C1H2R0CZ01D	K22174203		1-	A	F4
C 1546	CHIP CAP.	0.01uF	50V	B	GRM188B11H103KA01D	K22174823		1-	A	E4
C 1547	CHIP CAP.	0.01uF	50V	B	GRM188B11H103KA01D	K22174823		1-	A	E4
C 1548	CHIP CAP.	33pF	50V	CH	GRM1882C1H330JA01D	K22174223		1-	A	F4
C 1549	CHIP CAP.	12pF	50V	CH	GRM1882C1H120JA01D	K22174213		1-	A	E4
C 1551	CHIP CAP.	33pF	50V	CH	GRM1882C1H330JA01D	K22174223		1-	A	E4
C 1553	CHIP CAP.	33pF	50V	CH	GRM1882C1H330JA01D	K22174223		1-	A	E4
C 1563	CHIP CAP.	47pF	50V	CH	GRM1882C1H470JA01D	K22174227		1-	A	C4
C 1568	CHIP CAP.	82pF	50V	CH	GRM1882C1H820JA01D	K22174233		1	A	E2

MAIN Unit

Parts List

REF	DESCRIPTION	VALUE	V/W	TOL.	MFR'S DESIG	VXSTD P/N	VERS.	LOT	SIDE	LAY ADR
C 1568	CHIP CAP.	82pF	50V	CH	GRM1552C1H820JD01D	K22178234		2-5	A	E2
C 1569	CHIP CAP.	2pF	50V	CK	GRM1884C1H2R0CZ01D	K22174203		1-		
C 1570	CHIP CAP.	3pF	50V	CJ	GRM1883C1H3R0CZ01D	K22174204		1-		
C 1571	CHIP CAP.	0.01uF	50V	B	GRM188B11H103KA01D	K22174823		1-		
C 1572	CERAMIC CAP.	0.001uF	50V	B	UP050B102K-A-B	K28179001		1-		
C 1572	CHIP CAP.	0.001uF	50V	B	GRM188B11H102KA01D	K22174821		6-		
C 1573	AL.ELECTRO.CAP.	100uF	16V		RC2-16V101MF1#-T58	K46120007		1-		
C 1573	CHIP TA.CAP.	100uF	10V		TEMSVD1A107M12R	K78100031		6-		
C 1574	CHIP CAP.	0.1uF	16V	B	GRM188B11C104KA01D	K22124805		6-		
C 1576	CHIP TA.CAP.	0.47uF	25V		TESVA1E474M1-8R	K78140009		6-		
C 1577	CHIP CAP.	82pF	50V	CH	GRM1882C1H820JA01D	K22174233		6-		
C 1578	CHIP CAP.	22pF	50V	CH	GRM1882C1H220JA01D	K22174219		3-		
C 1579	CHIP CAP.	22pF	50V	CH	GRM1882C1H220JA01D	K22174219		3-		
CF1001	CERAMIC FILTER				CFWLB450KE1Y-B0	H3900568		1-	A	F5
CF1002	CERAMIC FILTER				CFWLB450KE1Y-B0	H3900568		1-	A	E5
D 1001	DIODE				BAS316	G2070716		1-	A	C6
D 1002	DIODE				BAS316	G2070716		1-	A	B6
D 1003	DIODE				BAS316	G2070716		1-	A	I6
D 1004	DIODE				BAS316	G2070716		1-	A	A1
D 1005	DIODE				BAS316	G2070716		1-	A	I6
D 1006	DIODE				BAS316	G2070716		1-	A	A1
D 1007	DIODE				1SR154-400 TE25	G2070684		1-	A	F6
D 1008	DIODE				BAS316	G2070716		1-	A	I6
D 1009	DIODE				BAS316	G2070716		1-	A	I6
D 1010	DIODE				BAS316	G2070716		1-	A	B1
D 1011	DIODE				DAP236U T106	G2070592		1-	A	C1
D 1012	DIODE				DAP236U T106	G2070592		1-	A	C1
D 1013	DIODE				BAS316	G2070716		1-	A	H6
D 1014	DIODE				BAS316	G2070716		1-	A	H6
D 1015	DIODE				BAS316	G2070716		1-	A	H6
D 1016	DIODE				BAS316	G2070716		1-	A	H6
D 1017	DIODE				BAS316	G2070716		1-	A	B5
D 1018	DIODE				DAP236U T106	G2070592		1-	A	D1
D 1019	DIODE				DAP236U T106	G2070592		1-	A	D1
D 1020	DIODE				BAS316	G2070716		1-	A	G2
D 1021	DIODE				BAS316	G2070716		1-	A	G1
D 1022	DIODE				BAS316	G2070716		1-	A	H1
D 1023	DIODE				BAS316	G2070716		1-	A	H1
D 1024	DIODE				BAS316	G2070716		1-	A	F3
D 1025	DIODE				BAS316	G2070716		1-	A	H3
D 1026	DIODE				BAS316	G2070716		1-	A	G2
D 1027	DIODE				HZM7.5NB3-TL-E	G2070786		1-	A	D4
D 1028	DIODE				BAS316	G2070716		1-	A	F4
D 1029	DIODE				BAS316	G2070716		1-	A	F1
D 1030	DIODE				BAS316	G2070716		1-	A	G1
D 1031	DIODE				HSB88WSTR	G2070290		1-	A	D2
D 1032	DIODE				HZM7.5NB3-TL-E	G2070786		1-	A	D4
D 1033	DIODE				IMN10 T108	G2070078		1-	A	G3
D 1034	DIODE				IMN10 T108	G2070078		1-	A	H3
D 1035	DIODE				HSC277TRF-E	G2070584		1-	A	D3
D 1036	DIODE				BAS316	G2070716		1-	A	B5
D 1037	DIODE				1SV271(TPH3.F)	G2070476		1-	A	D3
D 1038	DIODE				HZM7.5NB3-TL-E	G2070786		1-	A	D4
D 1039	DIODE				BAS316	G2070716		1-	A	F1
D 1040	DIODE				BAS316	G2070716		1-	A	B5
D 1041	DIODE				DAN202U T106	G2070162		1-	A	D4
D 1042	DIODE				DAN202U T106	G2070162		1-	A	D4
D 1043	DIODE				BAS316	G2070716		1-	A	B5
D 1044	DIODE				BAS316	G2070716		1-	A	C2
D 1045	DIODE				DAP236U T106	G2070592		1-	A	D3
D 1046	DIODE				BAS316	G2070716		1-	A	E6
D 1047	DIODE				BAS316	G2070716		1-	A	F2
D 1048	DIODE				DAN202U T106	G2070162		1-	A	E6
D 1049	DIODE				BAS316	G2070716		1-	A	E1
D 1051	DIODE				BAS316	G2070716		1-	A	E6
D 1052	DIODE				HSB88WSTR	G2070290		1-	A	D5
D 1053	DIODE				HSM198S-TR	G2070570		1-	A	E2
D 1054	DIODE				1SS372(TE85R.F)	G2070632		1-	A	E6
D 1055	DIODE				DAP236U T106	G2070592		1-	A	D4
D 1056	DIODE				BAS316	G2070716		1-	A	E5
D 1057	DIODE				BAS316	G2070716		1-	A	E5
D 1058	DIODE				BAS316	G2070716		1-	A	C5
D 1059	DIODE				BAS316	G2070716		1-	A	C5

MAIN Unit

Parts List

REF	DESCRIPTION	VALUE	V/W	TOL.	MFR'S DESIG	VXSTD P/N	VERS.	LOT	SIDE	LAY ADR
D 1060	DIODE				BAS316	G2070716		1-	A	C5
D 1061	DIODE				BAS316	G2070716		1-	A	C5
D 1062	DIODE				BAS316	G2070716		1-	A	E3
D 1063	DIODE				BAS316	G2070716		1-	A	E4
D 1064	DIODE				RN731V TE-17	G2070898		1-	A	D1
D 1065	DIODE				RN731V TE-17	G2070898		1-	A	D1
D 1066	DIODE				RN731V TE-17	G2070898		1-	A	D1
D 1067	DIODE				BAS316	G2070716		1-	A	A6
D 1068	DIODE				BAS316	G2070716		1-	A	A6
D 1069	DIODE				BAS316	G2070716		1-	A	E6
D 1070	DIODE				BAS316	G2070716		1-	A	B5
D 1071	DIODE				DAP202U T106	G2070160		1-	A	D6
D 1072	DIODE				BAS316	G2070716		1-	A	A6
D 1073	DIODE				RN142S TE61	G2070994		1-	A	F4
D 1074	DIODE				HSC277TRF-E	G2070584		1-	A	D3
D 1075	DIODE				BAS316	G2070716		1-	A	E6
D 1076	DIODE				BAS316	G2070716		1-	A	H2
D 1077	DIODE				BAS316	G2070716		1-	A	H2
D 1078	DIODE				RB751S-40TE61	G2070850		1-	A	B4
D 1079	DIODE				BAS316	G2070716		1-	A	E3
D 1080	DIODE				BAS316	G2070716		1-	A	E4
D 1081	DIODE				1SS226(TE85R.F)	G2070003		1-		
D 1082	SURGE ABSORBER				TVSF0603	Q9000847		3-		
FB1001	CHIP COI				BLM18BD182SN1D	L1690602		1-	A	A3
FB1002	CHIP COI				BLM18BD182SN1D	L1690602		1-	A	G6
FB1003	CHIP COI				BLM18BD182SN1D	L1690602		1-	A	A3
FB1004	CHIP COI				BLM18BD182SN1D	L1690602		1-	A	A3
FB1005	CHIP COI				BLM18BD182SN1D	L1690602		1-	A	A3
FB1006	CHIP COI				BLM18BD182SN1D	L1690602		1-	A	G6
FB1007	CHIP COI				BLM18BD182SN1D	L1690602		1-	A	A3
FB1008	CHIP COI				BLM18BD182SN1D	L1690602		1-	A	A3
FB1009	CHIP COI				BLM18BD182SN1D	L1690602		1-	A	A3
FB1010	CHIP COI				BLM18BD182SN1D	L1690602		1-	A	A3
FB1011	CHIP COI				BLM18BD182SN1D	L1690602		1-	A	F6
FB1012	CHIP COI				BLM18BD182SN1D	L1690602		1-	A	A3
FB1013	CHIP COI				BLM18BD182SN1D	L1690602		1-	A	A3
FB1014	CHIP COI				BLM18BD182SN1D	L1690602		1-	A	G6
FB1015	CHIP COI				BLM18BD182SN1D	L1690602		1-	A	A3
FB1016	CHIP COI				BLM18BD182SN1D	L1690602		1-	A	A3
FB1017	CHIP COI				BLM18BD182SN1D	L1690602		1-	A	A3
FB1018	CHIP COI				BLM18BD182SN1D	L1690602		1-	A	A4
FB1019	CHIP COI				BLM18BD182SN1D	L1690602		1-	A	A4
FB1020	CHIP COI				BLM18BD182SN1D	L1690602		1-	A	A4
FB1021	CHIP COI				BLM18BD182SN1D	L1690602		1-	A	A4
FB1022	CHIP COI				BLM18BD182SN1D	L1690602		1-	A	D6
FB1023	CHIP COI				BLM18BD182SN1D	L1690602		1-	A	C2
FB1024	CHIP COI				BLM18BD182SN1D	L1690602		1-	A	C2
J 1001	CONNECTOR				JPJ2545-01-510	P1090633		1-	A	H7
J 1002	CONNECTOR				JPJ2545-01-510	P1090633		1-	A	H7
J 1003	CONNECTOR				TMP-J01X-V6	P1090210		1-	A	I6
J 1004	CONNECTOR				TMP-J01X-V6	P1090210		1-	A	A1
J 1005	CONNECTOR				30FLT-SM1-TB	P1091142		1-	A	A3
J 1006	CONNECTOR				TCS5073-1941577	P1090913		1-	A	G7
J 1007	CONNECTOR				M500630434S-F R41-0599K	P1090925		1-	A	G7
J 1008	CONNECTOR				30FLT-SM1-TB	P1091142		1-	A	A4
J 1009	CONNECTOR				IMSA6065B-06-Z075-PT1	P0091455		1-	A	G5
J 1010	TERMINAL				P07	Q5000166		1-	A	F6
J 1011	TERMINAL				P07	Q5000166		1-	A	I6
J 1012	CONNECTOR				IMSA6065B-03-Z075-PT1	P0091454		1-	A	G3
J 1013	CONNECTOR				IMSA6065B-05-Z075-PT1	P0091416		1-	A	F4
J 1014	TERMINAL				P07	Q5000166		1-	A	I3
J 1015	CONNECTOR				SB20-03WS	P0090610		1-	A	D4
J 1016	CONNECTOR				IMSA-6065B-06-Z049-PT1	P0091383		1-	A	A2
J 1017	CONNECTOR				IMSA-6065B-05-Z049-PT1	P0091382		1-	A	B3
J 1018	CONNECTOR				IMSA6065B-10-Z075-PT1	P0091456		1-	A	G3
J 1019	TERMINAL				P07	Q5000166		1-	A	I3
J 1020	CONNECTOR				TMP-J01X-V6	P1090210		1-	A	C3
J 1021	CONNECTOR				IMSA6065B-05-Z075-PT1	P0091416		1-	A	G1
J 1022	TERMINAL				P07	Q5000166		1-	A	F1
J 1023	CONNECTOR				SB20-05WS	P0090612		1-	A	D5
J 1024	CONNECTOR				SB20-05WS	P0090612		1-	A	C3
J 1025	CONNECTOR				SB20-08WS	P0090615		1-	A	C2
J 1026	CONNECTOR				SB20-03WS	P0090610		1-	A	C5

MAIN Unit

Parts List

REF	DESCRIPTION	VALUE	V/W	TOL.	MFR'S DESIG	VXSTD P/N	VERS.	LOT	SIDE	LAY ADR
J 1027	CONNECTOR				TMP-J01X-V6	P1090210		1-	A	E2
J 1028	CONNECTOR				YKB21-5144	P1091234		1-	A	B7
J 1029	CONNECTOR				SB20-04WS	P0090611		1-	A	C6
J 1030	CONNECTOR				TMP-J01X-V6	P1090210		1-	A	E4
J 1031	CONNECTOR				TCS4650-0141577	P1090635		1-	A	F7
J 1032	CONNECTOR				TCS4640-01-4151	P1090634		1-	A	E7
J 1033	CONNECTOR				SB20-04WS	P0090611		1-	A	D5
J 1034	CONNECTOR				SB20-04WS	P0090611		1-	A	C5
J 1035	CONNECTOR				SB20-02WS	P0090609		1-	A	A6
J 1036	CONNECTOR				SB20-05WS	P0090612		1-	A	B4
J 1037	CONNECTOR				SB20-06WS	P0090613		1-	A	A5
J 1038	CONNECTOR				TMP-J01X-V6	P1090210		1-	A	D1
J 1039	CONNECTOR				TMP-J01X-V6	P1090210		1-	A	E4
J 1040	CONNECTOR				TMP-J01X-V6	P1090210		1-	A	D5
J 1041	CONNECTOR				TMP-J01X-V6	P1090210		1-	A	D3
J 1042	CONNECTOR				YKB21-5296N	P1091233		1-	A	A7
J 1043	CONNECTOR				LPR6520-3502F	P1091297		1-	A	C7
J 1044	CONNECTOR				TMP-J01X-V6	P1090210		1-	A	D6
J 1045	CONNECTOR				TMP-J01X-V6	P1090210		1-	A	A1
J 1046	TERMINAL				P07	Q5000166		1-	A	H5
J 1047	TERMINAL				P07	Q5000166		1-	A	F3
J 1048	TERMINAL				P07	Q5000166		1-	A	I1
J 1049	CONNECTOR				TMP-J01X-V6	P1090210		1-	A	H6
J 1050	CONNECTOR				TMP-J01X-V6	P1090210		1-	A	I3
J 1051	CONNECTOR				YKB21-5296N	P1091233		1-	A	A7
JP1001	WIRE ASSY				AH025H 160MM	T9207316		1-	A	D6
JP1003	WIRE ASSY				GRN 20 2/2	T50502000		1		
JP1004	WIRE ASSY				GRN 20 2/2	T50502000		1		
JP1005	WIRE ASSY				GRN 20 2/2	T50502000		1		
JP1006	WIRE ASSY				GRN 230 2/2	T50523000		1		
JP1007	WIRE ASSY				GRN 20 2/2	T50502000		1		
JP1008	WIRE ASSY				GRN 30 2/2	T50503000		1		
JP1009	WIRE ASSY				GRN 30 2/2	T50503000		1		
JP1010	WIRE ASSY				GRN 120 2/2	T50512000		2-5		
L 1001	M.RFC	1000uH			LLM3225-102J	L1691157		1-	A	C6
L 1002	CHIP COIL	1mH			LQH43MN102K03L	L1690108		1-	A	I6
L 1003	M.RFC	100uH			LLM3225-101J	L1691145		1-	A	C6
L 1004	M.RFC	100uH			LLM3225-101J	L1691145		1-	A	C6
L 1005	CHIP COIL	0.15uH		2%	C2520C-R15G	L1691296		1-	A	A1
L 1006	CHIP COIL	0.12uH		2%	C2520C-R12G	L1691295		1-	A	A1
L 1007	CHIP COIL	0.068uH		2%	C2520C-68NG	L1691292		1-	A	A1
L 1008	M.RFC	100uH			LLM3225-101J	L1691145		1-	A	F6
L 1009	M.RFC	10uH			LLM3225-100J	L1691133		1-	A	B1
L 1010	CHIP COIL	0.27uH		2%	C2520C-R27G	L1691299		1-	A	C1
L 1011	CHIP COIL	0.75uH		2%	C2520C-R75G	L1691306		1-	A	C1
L 1012	CHIP COIL	0.39uH		2%	C2520C-R39G	L1691301		1-	A	C1
L 1013	CHIP COIL	0.33uH		2%	C2520C-R33G	L1691300		1-	A	C1
L 1014	CHIP COIL	1uH		2%	C2520C-1R0G	L1691309		1-	A	C1
L 1015	CHIP COIL	0.56uH		2%	C2520C-R56G	L1691303		1-	A	C1
L 1016	CHIP COIL	0.22uH		2%	C2520C-R22G	L1691298		1-	A	C2
L 1017	CHIP COIL	0.27uH		2%	C2520C-R27G	L1691299		1-	A	C1
L 1018	CHIP COIL	0.75uH		2%	C2520C-R75G	L1691306		1-	A	C1
L 1019	CHIP COIL	0.39uH		2%	C2520C-R39G	L1691301		1-	A	C1
L 1020	CHIP COIL	0.22uH		2%	C2520C-R22G	L1691298		1-	A	C2
L 1021	CHIP COIL	1uH		2%	C2520C-1R0G	L1691309		1-	A	C1
L 1022	M.RFC	15uH			LLM3225-150J	L1691135		1-	A	C1
L 1023	M.RFC	2.7uH			LLM3225-2R7J	L1691126		1-	A	C1
L 1024	CHIP COIL	0.47uH		2%	C2520C-R47G	L1691302		1-	A	C2
L 1025	CHIP COIL	0.27uH		2%	C2520C-R27G	L1691299		1-	A	C1
L 1026	M.RFC	3.3uH			LLM3225-3R3J	L1691127		1-	A	C1
L 1027	CHIP COIL	0.68uH		2%	C2520C-R68G	L1691305		1-	A	C1
L 1028	CHIP COIL	0.18uH		2%	C2520C-R18G	L1691297		1-	A	C2
L 1029	CHIP COIL	0.27uH		2%	C2520C-R27G	L1691299		1-	A	C1
L 1030	M.RFC	3.3uH			LLM3225-3R3J	L1691127		1-	A	C1
L 1031	CHIP COIL	0.68uH		2%	C2520C-R68G	L1691305		1-	A	C1
L 1032	CHIP COIL	0.18uH		2%	C2520C-R18G	L1691297		1-	A	C2
L 1033	M.RFC	0.18uH			LLM3225-R18J	L1691112		1-	A	G2
L 1034	CHIP COIL	1uH		2%	C2520C-1R0G	L1691309		1-	A	D1
L 1035	M.RFC	15uH			LLM3225-150J	L1691135		1-	A	D1
L 1036	M.RFC	2.7uH			LLM3225-2R7J	L1691126		1-	A	D1
L 1037	CHIP COIL	0.47uH		2%	C2520C-R47G	L1691302		1-	A	C2
L 1038	M.RFC	0.18uH			LLM3225-R18J	L1691112		1-	A	G2
L 1039	M.RFC	0.15uH			LLM3225-R15J	L1691111		1-	A	F1

MAIN Unit

Parts List

REF	DESCRIPTION	VALUE	V/W	TOL.	MFR'S DESIG	VXSTD P/N	VERS.	LOT	SIDE	LAY ADR
L 1040	M.RFC	0.15uH			LLM3225-R15J	L1691111		1-	A	F1
L 1041	M.RFC	0.33uH			LLM3225-R33J	L1691115		1-	A	G2
L 1042	M.RFC	1.5uH			LLM3225-1R5J	L1691123		1-	A	H1
L 1043	M.RFC	0.12uH			LLM3225-R12J	L1691110		1-	A	G2
L 1044	M.RFC	10uH			LLM3225-100J	L1691133		1-	A	G2
L 1045	M.RFC	0.39uH			LLM3225-R39J	L1691116		1-	A	G1
L 1046	M.RFC	22uH			LLM3225-220J	L1691137		1-	A	H1
L 1047	M.RFC	6.8uH			LLM3225-6R8J	L1691131		1-	A	H1
L 1048	M.RFC	0.47uH			LLM3225-R47J	L1691117		1-	A	G2
L 1049	M.RFC	18uH			LLM3225-180J	L1691136		1-	A	G2
L 1050	M.RFC	0.33uH			LLM3225-R33J	L1691115		1-	A	G1
L 1051	M.RFC	6.8uH			LLM3225-6R8J	L1691131		1-	A	H1
L 1052	M.RFC	10uH			LLM3225-100J	L1691133		1-	A	G2
L 1053	M.RFC	1.5uH			LLM3225-1R5J	L1691123		1-	A	H1
L 1054	M.RFC	0.12uH			LLM3225-R12J	L1691110		1-	A	G2
L 1055	M.RFC	0.33uH			LLM3225-R33J	L1691115		1-	A	G1
L 1056	M.RFC	22uH			LLM3225-220J	L1691137		1-	A	H1
L 1057	CHIP COIL	0.15uH		2%	C2520C-R15G	L1691296		1-	A	D3
L 1058	M.RFC	0.33uH			LLM3225-R33J	L1691115		1-	A	G1
L 1059	CHIP COIL	0.15uH		2%	C2520C-R15G	L1691296		1-	A	F1
L 1060	CHIP COIL	0.15uH		2%	C2520C-R15G	L1691296		1-	A	D3
L 1061	CHIP COIL	0.15uH		2%	C2520C-R15G	L1691296		1-	A	F1
L 1062	CHIP COIL	0.1uH		2%	C2520C-R10G	L1691294		1-	A	F1
L 1063	CHIP COIL	2.2uH		2%	C2520C-2R2G	L1691313		1-	A	D3
L 1064	M.RFC	470uH			LLM3225-471J	L1691153		1-	A	D6
L 1065	M.RFC	47uH			LLM3225-470J	L1691141		1-	A	E1
L 1066	M.RFC	47uH			LLM3225-470J	L1691141		1-	A	E1
L 1067	M.RFC	470uH			LLM3225-471J	L1691153		1-	A	C2
L 1068	M.RFC	1000uH			LLM3225-102J	L1691157		1-	A	D5
L 1069	CHIP COIL	0.1uH		2%	C2520C-R10G	L1691294		1-	A	E2
L 1071	CHIP COIL	0.1uH		2%	C2520C-R10G	L1691294		1-	A	E2
L 1072	M.RFC	330uH			LLM3225-331J	L1691151		1-	A	F5
L 1073	M.RFC	470uH			LLM3225-471J	L1691153		1-	A	F6
L 1074	M.RFC	470uH			LLM3225-471J	L1691153		1-	A	F6
L 1075	CHIP COIL	4.7uH		2%	C2520C-4R7G	L1691317		1-	A	E1
L 1076	M.RFC	82uH			LLM3225-820J	L1691144		1-	A	D5
L 1077	M.RFC	470uH			LLM3225-471J	L1691153		1-	A	E6
L 1078	M.RFC	470uH			LLM3225-471J	L1691153		1-	A	E6
L 1079	CHIP COIL	0.068uH		2%	C2520C-68NG	L1691292		1-	A	D1
L 1080	M.RFC	470uH			LLM3225-471J	L1691153		1-	A	E6
L 1081	CHIP COIL	0.068uH		2%	C2520C-68NG	L1691292		1-	A	D1
L 1082	M.RFC	470uH			LLM3225-471J	L1691153		1-	A	D6
L 1083	CHIP COIL	2.2uH		2%	C2520C-2R2G	L1691313		1-	A	E3
L 1084	M.RFC	470uH			LLM3225-471J	L1691153		1-	A	E6
L 1085	M.RFC	1000uH			LLM3225-102J	L1691157		1-	A	B6
L 1086	CHIP COIL	0.1uH		2%	C2520C-R10G	L1691294		1-	A	D2
L 1087	CHIP COIL	0.1uH		2%	C2520C-R10G	L1691294		1-	A	D2
L 1088	CHIP COIL	0.15uH		2%	C2520C-R15G	L1691296		1-	A	D2
L 1089	M.RFC	100uH			LLM3225-101J	L1691145		1-	A	F5
L 1090	M.RFC	0.68uH			LK1608 R68K-T	L1690416		1-		
L 1091	M.RFC	0.18uH			LK1608 R18K-T	L1690392		3-		
L 1092	M.RFC	0.18uH			LK1608 R18K-T	L1690392		6-		
L 1093	M.RFC	0.18uH			LK1608 R18K-T	L1690392		6-		
P 1001	WIRE ASSY				GRA(L) 170 TMP/TMP	T9318278		1-		
P 1001	WIRE ASSY				GRA(L) 170 TMP/TMP	T9318278A		3-		
P 1002	WIRE ASSY				GRA(M) 270 TMP/TMP	T9318279		1-		
P 1002	WIRE ASSY				GRA(M) 270 TMP/TMP	T9318279A		3-		
Q 1001	POLY SWITCH				MINISMDC0505-02	G9090143		1-	A	B6
Q 1002	TRANSISTOR				DTC114EUA T106	G3070084		1-	A	A1
Q 1003	TRANSISTOR				DTC114EUA T106	G3070084		1-	A	I6
Q 1004	TRANSISTOR				DTC114EUA T106	G3070084		1-	A	B6
Q 1005	IC				NJU3714A(TAPE)	G1094291		1-	A	B4
Q 1006	FET				3SK131-T2B V12	G4801317B		1-	A	B1
Q 1007	TRANSISTOR				DTC114YUA T106	G3070298		1-	A	G6
Q 1008	TRANSISTOR				2SD2403GY-T1	G3424038Y		1-	A	F6
Q 1009	TRANSISTOR				DTC114YUA T106	G3070298		1-	A	G6
Q 1010	TRANSISTOR				2SC2954-T2	G3329547		1-	A	B1
Q 1011	TRANSISTOR				DTC114EUA T106	G3070084		1-	A	I6
Q 1012	IC				NJU3714A(TAPE)	G1094291		1-	A	A2
Q 1013	TRANSISTOR				2SC4154-T11-1E	G3341548E		1-	A	D1
Q 1014	TRANSISTOR				2SC4154-T11-1E	G3341548E		1-	A	D1
Q 1015	TRANSISTOR				2SC4154-T11-1E	G3341548E		1-	A	D1
Q 1016	TRANSISTOR				2SC4154-T11-1E	G3341548E		1-	A	D2

MAIN Unit

Parts List

REF	DESCRIPTION	VALUE	V/W	TOL.	MFR'S DESIG	VXSTD P/N	VERS.	LOT	SIDE	LAY ADR
Q 1017	TRANSISTOR				DTC114EUA T106	G3070084		1-	A	H6
Q 1018	IC				SN74HCT244PWR	G1094091		1-	A	A3
Q 1019	TRANSISTOR				DTC114EUA T106	G3070084		1-	A	H6
Q 1020	IC				M62353AGP	G1094272		1-	A	B3
Q 1021	IC				M62364FP 600D	G1093033		1-	A	B3
Q 1022	TRANSISTOR				UMD5N TR	G3070343		1-	A	G3
Q 1023	FET				SST310-T1	G4070009		1-	A	D3
Q 1024	FET				SST310-T1	G4070009		1-	A	D3
Q 1025	TRANSISTOR				2SC4154-T11-1E	G3341548E		1-	A	D3
Q 1026	TRANSISTOR				2SC4154-T11-1E	G3341548E		1-	A	C2
Q 1027	IC				CD74HCT4053PWR	G1094273		1-	A	C3
Q 1028	IC				BB301CAW-TL	G1093186		1-	A	D3
Q 1029	TRANSISTOR				2SC3356-T2B R24	G3333567D		1-	A	E1
Q 1030	TRANSISTOR				2SC3356-T2B R24	G3333567D		1-	A	E1
Q 1031	TRANSISTOR				UMD5N TR	G3070343		1-	A	G3
Q 1032	IC				NJM2068V-TE1	G1094112		1-	A	D5
Q 1033	TRANSISTOR				2SC4154-T11-1E	G3341548E		1-	A	C4
Q 1034	TRANSISTOR				2SC4154-T11-1E	G3341548E		1-	A	E6
Q 1035	TRANSISTOR				DTC144EUA T106	G3070041		1-	A	D4
Q 1036	TRANSISTOR				UMD5N TR	G3070343		1-	A	F3
Q 1037	TRANSISTOR				UMD5N TR	G3070343		1-	A	G1
Q 1038	TRANSISTOR				2SC4154-T11-1E	G3341548E		1-	A	E5
Q 1039	TRANSISTOR				UMD5N TR	G3070343		1-	A	H1
Q 1040	TRANSISTOR				2SA1602A-T11-1F	G3116028F		1-	A	E5
Q 1041	TRANSISTOR				UMD5N TR	G3070343		1-	A	G2
Q 1042	TRANSISTOR				UMD5N TR	G3070343		1-	A	G3
Q 1043	IC				CD74HCT4053PWR	G1094273		1-	A	C4
Q 1044	TRANSISTOR				2SA1602A-T11-1F	G3116028F		1-	A	E5
Q 1045	TRANSISTOR				UMD5N TR	G3070343		1-	A	F1
Q 1046	IC				SN74LVC2G53DCTR	G1094048		1-	A	C5
Q 1047	TRANSISTOR				UMD5N TR	G3070343		1-	A	H1
Q 1048	TRANSISTOR				2SC4154-T11-1E	G3341548E		1-	A	E5
Q 1049	TRANSISTOR				UMD5N TR	G3070343		1-	A	E1
Q 1050	TRANSISTOR				DTC144EUA T106	G3070041		1-	A	D4
Q 1051	IC				SN74LVC1G66DCKR	G1094046		1-	A	E5
Q 1052	TRANSISTOR				UMD5N TR	G3070343		1-	A	G3
Q 1053	TRANSISTOR				2SC2714Y(TE85R.F)	G3327147Y		1-	A	D3
Q 1054	IC				M62364FP 600D	G1093033		1-	A	B6
Q 1055	TRANSISTOR				UMD5N TR	G3070343		1-	A	E1
Q 1056	IC				HD74LV2G74A(TAPE)	G1093788		1-	A	C5
Q 1057	TRANSISTOR				2SC4154-T11-1E	G3341548E		1-	A	E5
Q 1058	IC				SPM5001-TL-E	G1093686		1-	A	E2
Q 1059	IC				CD74HCT4053PWR	G1094273		1-	A	C6
Q 1060	TRANSISTOR				UMD5N TR	G3070343		1-	A	G3
Q 1061	TRANSISTOR				UMD5N TR	G3070343		1-	A	F2
Q 1062	TRANSISTOR				2SC4154-T11-1E	G3341548E		1-	A	E5
Q 1063	IC				HD74LV2G74A(TAPE)	G1093788		1-	A	C5
Q 1064	IC				LM2904PWR	G1094010		1-	A	E1
Q 1065	TRANSISTOR				2SC4154-T11-1E	G3341548E		1	A	F2
Q 1066	TRANSISTOR				UMD5N TR	G3070343		1-	A	G3
Q 1067	TRANSISTOR				UMD5N TR	G3070343		1-	A	F4
Q 1068	TRANSISTOR				2SC4154-T11-1E	G3341548E		1-	A	F5
Q 1069	IC				CD74HCT4053PWR	G1094273		1-	A	D6
Q 1070	FET				SST310-T1	G4070009		1-	A	E3
Q 1071	TRANSISTOR				UMD5N TR	G3070343		1-	A	G3
Q 1072	TRANSISTOR				2SC4154-T11-1E	G3341548E		1-	A	E1
Q 1073	IC				BB301CAW-TL	G1093186		1-	A	F5
Q 1074	IC				NJM2068V-TE1	G1094112		1-	A	B1
Q 1075	IC				NJM2068V-TE1	G1094112		1-	A	D4
Q 1076	IC				NJM2068V-TE1	G1094112		1-	A	D4
Q 1077	IC				NJM2068V-TE1	G1094112		1-	A	D4
Q 1078	IC				NJM2068V-TE1	G1094112		1-	A	C4
Q 1079	IC				LM2904PWR	G1094010		1-	A	C4
Q 1080	IC				LM2902PWR	G1094009		1-	A	C5
Q 1081	IC				NJM2594V-TE1	G1093750		1-	A	E4
Q 1082	IC				NJU3714A(TAPE)	G1094291		1-	A	G5
Q 1083	IC				LM2904PWR	G1094010		1-	A	C5
Q 1084	TRANSISTOR				2SC2954-T2	G3329547		1-	A	D1
Q 1085	IC				BB301CAW-TL	G1093186		1-	A	F5
Q 1086	IC				LA4425A	G1092241		1-	A	A5
Q 1087	TRANSISTOR				2SC4154-T11-1E	G3341548E		1-	A	D5
Q 1088	IC				LM4881MX	G1093712		1-	A	B5
Q 1089	TRANSISTOR				DTC114EUA T106	G3070084		1-	A	F6

MAIN Unit

Parts List

REF	DESCRIPTION	VALUE	V/W	TOL.	MFR'S DESIG	VXSTD P/N	VERS.	LOT	SIDE	LAY ADR
Q 1090	IC				NJM2737V(TAPE)	G1094292		1-	A	B5
Q 1091	IC				SN74LVC2G66DCTR	G1094049		1-	A	B5
Q 1092	TRANSISTOR				2SA1602A-T11-1F	G3116028F		1-	A	A6
Q 1093	FET				SST310-T1	G4070009		1-	A	F5
Q 1094	FET				SST310-T1	G4070009		1-	A	F5
Q 1095	TRANSISTOR				2SC4154-T11-1E	G3341548E		1-	A	A6
Q 1096	IC				NJM2737V(TAPE)	G1094292		1-	A	C4
Q 1097	IC				NJU3714A(TAPE)	G1094291		1-	A	G5
Q 1098	IC				NJM2594V-TE1	G1093750		1-	A	D4
Q 1099	IC				LM2902PWR	G1094009		1-	A	B5
Q 1100	IC				CD74HCT4053PWR	G1094273		1-	A	C4
Q 1101	TRANSISTOR				2SC4154-T11-1E	G3341548E		1-	A	F5
Q 1102	IC				NJM2737V(TAPE)	G1094292		1-	A	C3
Q 1103	TRANSISTOR				2SC2714Y(TE85R.F)	G3327147Y		1-	A	E4
Q 1104	TRANSISTOR				UMD5N TR	G3070343		1-	A	A6
Q 1105	IC				BB301CAW-TL	G1093186		1-	A	E4
Q 1106	TRANSISTOR				2SC4154-T11-1E	G3341548E		1-	A	D4
Q 1107	FET				SST310-T1	G4070009		1-	A	E3
Q 1108	IC				LM2904PWR	G1094010		1-	A	G6
Q 1109	IC				LM2904PWR	G1094010		1-	A	B4
Q 1110	IC				LM2904PWR	G1094010		1-	A	A5
Q 1111	IC				TC74HC04AF(EL.F)	G1093499		1-	A	B3
Q 1112	TRANSISTOR				DTC114EUA T106	G3070084		1-	A	H2
Q 1113	IC				LM2904PWR	G1094010		1-	A	F5
Q 1114	TRANSISTOR				UMD5N TR	G3070343		1-	A	E4
Q 1115	TRANSISTOR				2SC4154-T11-1E	G3341548E		1-	A	A5
R 1001	CHIP RES.	100	1/16W	5%	RMC1/16 101JATP	J24185101		1-	A	C6
R 1002	CHIP RES.	1k	1/16W	5%	RMC1/16 102JATP	J24185102		1-	A	G6
R 1003	CHIP RES.	470	1/16W	5%	RMC1/16 471JATP	J24185471		1-	A	I6
R 1004	CHIP RES.	100	1/16W	5%	RMC1/16 101JATP	J24185101		1-	A	C6
R 1005	CHIP RES.	47	1/16W	5%	RMC1/16 470JATP	J24185470		1-	A	I6
R 1006	CHIP RES.	100	1/16W	5%	RMC1/16 101JATP	J24185101		1-	A	I6
R 1007	CHIP RES.	10k	1/16W	5%	RMC1/16 103JATP	J24185103		1-	A	A1
R 1008	CHIP RES.	1k	1/16W	5%	RMC1/16 102JATP	J24185102		1-	A	A1
R 1009	CHIP RES.	1k	1/16W	5%	RMC1/16 102JATP	J24185102		1-	A	G6
R 1010	CHIP RES.	100	1/16W	5%	RMC1/16 101JATP	J24185101		1-	A	B6
R 1011	CHIP RES.	27	1/16W	5%	RMC1/16 270JATP	J24185270		1-	A	A1
R 1012	CHIP RES.	39	1/16W	5%	RMC1/16 390JATP	J24185390		1-	A	A1
R 1013	CHIP RES.	100	1/16W	5%	RMC1/16 101JATP	J24185101		2-	A	G6
R 1014	CHIP RES.	100	1/16W	5%	RMC1/16 101JATP	J24185101		2-	A	G6
R 1015	CHIP RES.	100	1/16W	5%	RMC1/16 101JATP	J24185101		1-	A	H6
R 1016	CHIP RES.	100	1/16W	5%	RMC1/16 101JATP	J24185101		2-	A	G6
R 1017	CHIP RES.	27	1/16W	5%	RMC1/16 270JATP	J24185270		1-	A	A1
R 1018	CHIP RES.	4.7k	1/16W	5%	RMC1/16 472JATP	J24185472		1-	A	B1
R 1019	CHIP RES.	1k	1/16W	5%	RMC1/16 102JATP	J24185102		1-	A	F6
R 1020	CHIP RES.	47	1/16W	5%	RMC1/16 470JATP	J24185470		1-	A	B1
R 1021	CHIP RES.	100	1/16W	5%	RMC1/16 101JATP	J24185101		1-	A	A1
R 1022	CHIP RES.	100	1/16W	5%	RMC1/16 101JATP	J24185101		1-	A	I6
R 1023	CHIP RES.	10k	1/16W	5%	RMC1/16 103JATP	J24185103		1-	A	B1
R 1024	CHIP RES.	33	1/16W	5%	RMC1/16 330JATP	J24185330		1-	A	B1
R 1025	CHIP RES.	1k	1/16W	5%	RMC1/16 102JATP	J24185102		1-	A	G6
R 1026	CHIP RES.	150	1/16W	5%	RMC1/16 151JATP	J24185151		1-	A	I6
R 1027	CHIP RES.	68	1/16W	5%	RMC1/16 680JATP	J24185680		1-	A	I6
R 1028	CHIP RES.	4.7k	1/16W	5%	RMC1/16 472JATP	J24185472		1-	A	B1
R 1030	CHIP RES.	100	1/16W	5%	RMC1/16 101JATP	J24185101		1-	A	F6
R 1031	CHIP RES.	100	1/16W	5%	RMC1/16 101JATP	J24185101		1-	A	G6
R 1032	CHIP RES.	150	1/16W	5%	RMC1/16 151JATP	J24185151		1-	A	B1
R 1033	CHIP RES.	10k	1/16W	5%	RMC1/16 103JATP	J24185103		1-	A	B1
R 1034	CHIP RES.	220	1/16W	5%	RMC1/16 221JATP	J24185221		1-	A	B1
R 1035	CHIP RES.	47k	1/16W	5%	RMC1/16 473JATP	J24185473		1-	A	B1
R 1036	CHIP RES.	8.2	1/16W	5%	RMC1/16 8R2JATP	J24185829		1-	A	B1
R 1037	CHIP RES.	47	1/2W	5%	RMC1/2 470JCTP	J24275470		1-	A	B1
R 1038	CHIP RES.	47	1/16W	5%	RMC1/16 470JATP	J24185470		1-	A	B1
R 1039	CHIP RES.	0	1/16W	5%	RMC1/16 000JATP	J24185000		1-	A	B1
R 1040	CARBON FILM RES.	1k	1/6W	5%	RD16PJ102 1K	J01225102		1	A	H6
R 1040	CHIP RES.	1k	1/16W	5%	RMC1/16 102JATP	J24185102		2-	A	H6
R 1041	CHIP RES.	470	1/16W	5%	RMC1/16 471JATP	J24185471		1-	A	B4
R 1042	CHIP RES.	4.7k	1/16W	5%	RMC1/16 472JATP	J24185472		1-	A	F6
R 1043	CHIP RES.	1k	1/16W	5%	RMC1/16 102JATP	J24185102		1-	A	F6
R 1044	CHIP RES.	470	1/16W	5%	RMC1/16 471JATP	J24185471		1-	A	B3
R 1045	CHIP RES.	680	1/16W	5%	RMC1/16 681JATP	J24185681		1-	A	B1
R 1046	CHIP RES.	100	1/4W	5%	RMC1/4 101JATP	J24245101		1-	A	B1
R 1047	CHIP RES.	470	1/16W	5%	RMC1/16 471JATP	J24185471		1-	A	B3

MAIN Unit

Parts List

REF	DESCRIPTION	VALUE	V/W	TOL.	MFR'S DESIG	VXSTD P/N	VERS.	LOT	SIDE	LAY ADR
R 1048	CHIP RES.	1k	1/16W	5%	RMC1/16 102JATP	J24185102		1-	A	C1
R 1049	CHIP RES.	100	1/16W	5%	RMC1/16 101JATP	J24185101		1-	A	H6
R 1050	CHIP RES.	330	1/16W	5%	RMC1/16 331JATP	J24185331		1-	A	B1
R 1051	CHIP RES.	100	1/16W	5%	RMC1/16 101JATP	J24185101		1-	A	B1
R 1052	CHIP RES.	1k	1/16W	5%	RMC1/16 102JATP	J24185102		1-	A	G6
R 1053	CHIP RES.	10k	1/16W	5%	RMC1/16 103JATP	J24185103		1-	A	D1
R 1054	CHIP RES.	10k	1/16W	5%	RMC1/16 103JATP	J24185103		1-	A	D1
R 1055	CHIP RES.	1k	1/16W	5%	RMC1/16 102JATP	J24185102		1-	A	G6
R 1056	CHIP RES.	470	1/16W	5%	RMC1/16 471JATP	J24185471		1-	A	A2
R 1057	CHIP RES.	10k	1/16W	5%	RMC1/16 103JATP	J24185103		1-	A	D1
R 1058	CHIP RES.	10k	1/16W	5%	RMC1/16 103JATP	J24185103		1-	A	D2
R 1059	CHIP RES.	470	1/16W	5%	RMC1/16 471JATP	J24185471		1-	A	G6
R 1060	CHIP RES.	470	1/16W	5%	RMC1/16 471JATP	J24185471		1-	A	A2
R 1061	CHIP RES.	47k	1/16W	5%	RMC1/16 473JATP	J24185473		1-	A	D1
R 1062	CHIP RES.	47k	1/16W	5%	RMC1/16 473JATP	J24185473		1-	A	D1
R 1063	CHIP RES.	100	1/16W	5%	RMC1/16 101JATP	J24185101		1-	A	D1
R 1064	CHIP RES.	10k	1/16W	5%	RMC1/16 103JATP	J24185103		1-	A	B4
R 1065	CHIP RES.	1k	1/16W	5%	RMC1/16 102JATP	J24185102		1-	A	B4
R 1066	CHIP RES.	100	1/16W	5%	RMC1/16 101JATP	J24185101		1-	A	H6
R 1067	CHIP RES.	100	1/16W	5%	RMC1/16 101JATP	J24185101		1-	A	D1
R 1068	CHIP RES.	100	1/16W	5%	RMC1/16 101JATP	J24185101		1-	A	H6
R 1069	CHIP RES.	47k	1/16W	5%	RMC1/16 473JATP	J24185473		1-	A	D1
R 1070	CHIP RES.	47k	1/16W	5%	RMC1/16 473JATP	J24185473		1-	A	D2
R 1071	CHIP RES.	100	1/16W	5%	RMC1/16 101JATP	J24185101		1-	A	D1
R 1072	CHIP RES.	100	1/16W	5%	RMC1/16 101JATP	J24185101		1-	A	D2
R 1073	CHIP RES.	470	1/16W	5%	RMC1/16 471JATP	J24185471		1-	A	A3
R 1074	CHIP RES.	470	1/16W	5%	RMC1/16 471JATP	J24185471		1-	A	A3
R 1075	CHIP RES.	47k	1/16W	5%	RMC1/16 473JATP	J24185473		1-	A	B4
R 1076	CHIP RES.	100	1/16W	5%	RMC1/16 101JATP	J24185101		1-	A	C1
R 1077	CHIP RES.	100	1/16W	5%	RMC1/16 101JATP	J24185101		1-	A	C1
R 1078	CHIP RES.	10k	1/16W	5%	RMC1/16 103JATP	J24185103		1-	A	B4
R 1079	CHIP RES.	470	1/16W	5%	RMC1/16 471JATP	J24185471		1-	A	A3
R 1080	CHIP RES.	100	1/16W	5%	RMC1/16 101JATP	J24185101		1-	A	C1
R 1081	CHIP RES.	470	1/16W	5%	RMC1/16 471JATP	J24185471		1-	A	A4
R 1082	CHIP RES.	100	1/16W	5%	RMC1/16 101JATP	J24185101		1-	A	C1
R 1083	CHIP RES.	470	1/16W	5%	RMC1/16 471JATP	J24185471		1-	A	A3
R 1084	CHIP RES.	470	1/16W	5%	RMC1/16 471JATP	J24185471		1-	A	A4
R 1085	CHIP RES.	12k	1/16W	5%	RMC1/16 123JATP	J24185123		1-	A	B4
R 1086	CHIP RES.	33k	1/16W	5%	RMC1/16 333JATP	J24185333		1-	A	C4
R 1088	CHIP RES.	10	1/16W	5%	RMC1/16 100JATP	J24185100		1-	A	B3
R 1089	CHIP RES.	220k	1/16W	5%	RMC1/16 224JATP	J24185224		1-	A	F4
R 1090	CHIP RES.	100	1/16W	5%	RMC1/16 101JATP	J24185101		1-	A	G2
R 1091	CHIP RES.	100	1/16W	5%	RMC1/16 101JATP	J24185101		1-	A	G1
R 1092	CHIP RES.	100	1/16W	5%	RMC1/16 101JATP	J24185101		1-	A	H1
R 1093	CHIP RES.	100	1/16W	5%	RMC1/16 101JATP	J24185101		1-	A	H1
R 1094	CHIP RES.	100	1/16W	5%	RMC1/16 101JATP	J24185101		1-	A	F3
R 1095	CHIP RES.	100	1/16W	5%	RMC1/16 101JATP	J24185101		1-	A	H3
R 1096	CHIP RES.	100	1/16W	5%	RMC1/16 101JATP	J24185101		1-	A	G2
R 1097	CHIP RES.	470	1/16W	5%	RMC1/16 471JATP	J24185471		1-	A	B2
R 1098	CHIP RES.	470k	1/16W	5%	RMC1/16 474JATP	J24185474		1-	A	F4
R 1099	CHIP RES.	1k	1/16W	5%	RMC1/16 102JATP	J24185102		1-	A	D2
R 1100	CHIP RES.	470	1/16W	5%	RMC1/16 471JATP	J24185471		1-	A	B3
R 1101	CHIP RES.	27	1/16W	5%	RMC1/16 270JATP	J24185270		1-	A	H1
R 1102	CHIP RES.	100	1/16W	5%	RMC1/16 101JATP	J24185101		1-	A	F1
R 1103	CHIP RES.	100	1/16W	5%	RMC1/16 101JATP	J24185101		1-	A	G1
R 1104	CHIP RES.	470	1/16W	5%	RMC1/16 471JATP	J24185471		1-	A	B3
R 1105	CHIP RES.	33	1/16W	5%	RMC1/16 330JATP	J24185330		1-	A	H1
R 1106	CHIP RES.	22k	1/16W	5%	RMC1/16 223JATP	J24185223		1-	A	D4
R 1107	CHIP RES.	27	1/16W	5%	RMC1/16 270JATP	J24185270		1-	A	H1
R 1108	CHIP RES.	22k	1/16W	5%	RMC1/16 223JATP	J24185223		1-	A	D4
R 1109	CHIP RES.	47k	1/16W	5%	RMC1/16 473JATP	J24185473		1-	A	D4
R 1110	CHIP RES.	22k	1/16W	5%	RMC1/16 223JATP	J24185223		1-	A	F4
R 1111	CHIP RES.	10k	1/16W	5%	RMC1/16 103JATP	J24185103		1-	A	F4
R 1112	CHIP RES.	47k	1/16W	5%	RMC1/16 473JATP	J24185473		1-	A	D4
R 1113	CHIP RES.	10	1/16W	5%	RMC1/16 100JATP	J24185100		1-	A	D2
R 1114	CHIP RES.	150	1/16W	5%	RMC1/16 151JATP	J24185151		1-	A	D2
R 1115	CHIP RES.	10	1/16W	5%	RMC1/16 100JATP	J24185100		1-	A	D2
R 1116	CHIP RES.	470	1/16W	5%	RMC1/16 471JATP	J24185471		1-	A	C3
R 1117	CHIP RES.	470	1/16W	5%	RMC1/16 471JATP	J24185471		1-	A	C3
R 1118	CHIP RES.	4.7k	1/16W	5%	RMC1/16 472JATP	J24185472		1-	A	D4
R 1119	CHIP RES.	470	1/16W	5%	RMC1/16 471JATP	J24185471		1-	A	C3
R 1120	CHIP RES.	4.7k	1/16W	5%	RMC1/16 472JATP	J24185472		1-	A	D4
R 1121	CHIP RES.	2.2k	1/16W	5%	RMC1/16 222JATP	J24185222		1-	A	C3

MAIN Unit

Parts List

REF	DESCRIPTION	VALUE	V/W	TOL.	MFR'S DESIG	VXSTD P/N	VERS.	LOT	SIDE	LAY ADR
R 1122	CHIP RES.	100k	1/16W	5%	RMC1/16 104JATP	J24185104		1-	A	B3
R 1123	CHIP RES.	4.7k	1/16W	5%	RMC1/16 472JATP	J24185472		1-	A	D4
R 1124	CHIP RES.	3.3k	1/16W	5%	RMC1/16 332JATP	J24185332		1-	A	B3
R 1125	CHIP RES.	4.7k	1/16W	5%	RMC1/16 472JATP	J24185472		1-	A	D4
R 1126	CHIP RES.	10k	1/16W	5%	RMC1/16 103JATP	J24185103		1-	A	C3
R 1127	CHIP RES.	150	1/16W	5%	RMC1/16 151JATP	J24185151		1-	A	D3
R 1128	CHIP RES.	10k	1/16W	5%	RMC1/16 103JATP	J24185103		1-	A	B3
R 1129	CHIP RES.	22k	1/16W	5%	RMC1/16 223JATP	J24185223		1-	A	D4
R 1130	CHIP RES.	100k	1/16W	5%	RMC1/16 104JATP	J24185104		1-	A	D4
R 1131	CHIP RES.	1k	1/16W	5%	RMC1/16 102JATP	J24185102		1-	A	B4
R 1132	CHIP RES.	10k	1/16W	5%	RMC1/16 103JATP	J24185103		1-	A	B3
R 1133	CHIP RES.	150k	1/16W	5%	RMC1/16 154JATP	J24185154		1-	A	D4
R 1134	CHIP RES.	270k	1/16W	5%	RMC1/16 274JATP	J24185274		1-	A	D4
R 1135	CHIP RES.	47	1/16W	5%	RMC1/16 470JATP	J24185470		1-	A	B4
R 1136	CHIP RES.	3.3k	1/16W	5%	RMC1/16 332JATP	J24185332		1-	A	B3
R 1137	CHIP RES.	10k	1/16W	5%	RMC1/16 103JATP	J24185103		1-	A	C3
R 1138	CHIP RES.	33	1/16W	5%	RMC1/16 330JATP	J24185330		1-	A	D3
R 1139	CHIP RES.	220k	1/16W	5%	RMC1/16 224JATP	J24185224		1-	A	C3
R 1140	CHIP RES.	10k	1/16W	5%	RMC1/16 103JATP	J24185103		1-	A	C4
R 1141	CHIP RES.	4.7k	1/16W	5%	RMC1/16 472JATP	J24185472		1-	A	B5
R 1142	CHIP RES.	47k	1/16W	5%	RMC1/16 473JATP	J24185473		1-	A	D4
R 1143	CHIP RES.	47	1/16W	5%	RMC1/16 470JATP	J24185470		1-	A	C3
R 1144	CHIP RES.	10k	1/16W	5%	RMC1/16 103JATP	J24185103		1-	A	D4
R 1145	CHIP RES.	100	1/16W	5%	RMC1/16 101JATP	J24185101		1-	A	D3
R 1146	CHIP RES.	4.7k	1/16W	5%	RMC1/16 472JATP	J24185472		1-	A	D4
R 1147	CHIP RES.	470k	1/16W	5%	RMC1/16 474JATP	J24185474		1-	A	D4
R 1148	CHIP RES.	10k	1/16W	5%	RMC1/16 103JATP	J24185103		1-	A	C4
R 1149	CHIP RES.	47k	1/16W	5%	RMC1/16 473JATP	J24185473		1-	A	C3
R 1150	CHIP RES.	100k	1/16W	5%	RMC1/16 104JATP	J24185104		1-	A	C3
R 1151	CHIP RES.	33	1/16W	5%	RMC1/16 330JATP	J24185330		1-	A	D3
R 1152	CHIP RES.	10k	1/16W	5%	RMC1/16 103JATP	J24185103		1-	A	D4
R 1153	CHIP RES.	3.3M	1/16W	5%	RMC1/16 335JATP	J24185335		1-	A	C4
R 1154	CHIP RES.	39k	1/16W	5%	RMC1/16 393JATP	J24185393		1-	A	D4
R 1155	CHIP RES.	10k	1/16W	5%	RMC1/16 103JATP	J24185103		1-	A	C4
R 1156	CHIP RES.	220k	1/16W	5%	RMC1/16 224JATP	J24185224		1-	A	C3
R 1157	CHIP RES.	100	1/16W	5%	RMC1/16 101JATP	J24185101		1-	A	D3
R 1158	CHIP RES.	100k	1/16W	5%	RMC1/16 104JATP	J24185104		1-	A	D4
R 1159	CHIP RES.	47k	1/16W	5%	RMC1/16 473JATP	J24185473		1-	A	D4
R 1160	CHIP RES.	100	1/16W	5%	RMC1/16 101JATP	J24185101		1-	A	C3
R 1161	CHIP RES.	2.2k	1/16W	5%	RMC1/16 222JATP	J24185222		1-	A	B5
R 1162	CHIP RES.	470k	1/16W	5%	RMC1/16 474JATP	J24185474		1-	A	B5
R 1163	CHIP RES.	100	1/16W	5%	RMC1/16 101JATP	J24185101		1-	A	F1
R 1164	CHIP RES.	3.9k	1/16W	5%	RMC1/16 392JATP	J24185392		1-	A	D3
R 1165	CHIP RES.	47	1/16W	5%	RMC1/16 470JATP	J24185470		1-	A	D3
R 1166	CHIP RES.	10k	1/16W	5%	RMC1/16 103JATP	J24185103		1-	A	D3
R 1167	CHIP RES.	100k	1/16W	5%	RMC1/16 104JATP	J24185104		1-	A	D4
R 1168	CHIP RES.	2.2k	1/16W	5%	RMC1/16 222JATP	J24185222		1-	A	B5
R 1169	CHIP RES.	10k	1/16W	5%	RMC1/16 103JATP	J24185103		1-	A	D3
R 1170	CHIP RES.	470	1/16W	5%	RMC1/16 471JATP	J24185471		1-	A	C3
R 1171	CHIP RES.	150k	1/16W	5%	RMC1/16 154JATP	J24185154		1-	A	D4
R 1172	CHIP RES.	1k	1/16W	5%	RMC1/16 102JATP	J24185102		1-	A	E1
R 1173	CHIP RES.	1k	1/16W	5%	RMC1/16 102JATP	J24185102		1-	A	E1
R 1174	CHIP RES.	47	1/16W	5%	RMC1/16 470JATP	J24185470		1-	A	D3
R 1175	CHIP RES.	47	1/16W	5%	RMC1/16 470JATP	J24185470		1-	A	D3
R 1176	CHIP RES.	2.2k	1/16W	5%	RMC1/16 222JATP	J24185222		1-	A	B5
R 1177	CHIP RES.	2.2k	1/16W	5%	RMC1/16 222JATP	J24185222		1-	A	C3
R 1178	CHIP RES.	68	1/16W	5%	RMC1/16 680JATP	J24185680		1-	A	C2
R 1179	CHIP RES.	47	1/16W	5%	RMC1/16 470JATP	J24185470		1-	A	D5
R 1180	CHIP RES.	150	1/10W	5%	RMC1/10T 151J	J24205151		1-	A	E1
R 1181	CHIP RES.	150	1/10W	5%	RMC1/10T 151J	J24205151		1-	A	E1
R 1182	CHIP RES.	330k	1/16W	5%	RMC1/16 334JATP	J24185334		1-	A	B5
R 1183	CHIP RES.	100k	1/16W	5%	RMC1/16 104JATP	J24185104		1-	A	C2
R 1184	CHIP RES.	33k	1/16W	5%	RMC1/16 333JATP	J24185333		1-	A	C2
R 1185	CHIP RES.	68k	1/16W	5%	RMC1/16 683JATP	J24185683		1-	A	D5
R 1186	CHIP RES.	47k	1/16W	5%	RMC1/16 473JATP	J24185473		1-	A	D4
R 1187	CHIP RES.	100	1/16W	5%	RMC1/16 101JATP	J24185101		1-	A	C3
R 1188	CHIP RES.	10k	1/16W	5%	RMC1/16 103JATP	J24185103		1-	A	D4
R 1189	CHIP RES.	470k	1/16W	5%	RMC1/16 474JATP	J24185474		1-	A	B5
R 1190	CHIP RES.	2.2k	1/16W	5%	RMC1/16 222JATP	J24185222		1-	A	B5
R 1191	CHIP RES.	10k	1/16W	5%	RMC1/16 103JATP	J24185103		1-	A	B5
R 1192	CHIP RES.	47k	1/16W	5%	RMC1/16 473JATP	J24185473		1-	A	C2
R 1193	CHIP RES.	10k	1/16W	5%	RMC1/16 103JATP	J24185103		1-	A	D6
R 1194	CHIP RES.	100k	1/16W	5%	RMC1/16 104JATP	J24185104		1-	A	C3

MAIN Unit

Parts List

REF	DESCRIPTION	VALUE	V/W	TOL.	MFR'S DESIG	VXSTD P/N	VERS.	LOT	SIDE	LAY ADR
R 1195	CHIP RES.	33	1/16W	5%	RMC1/16 330JATP	J24185330		1-	A	E1
R 1196	CHIP RES.	1k	1/16W	5%	RMC1/16 102JATP	J24185102		1-	A	E1
R 1197	CHIP RES.	33	1/16W	5%	RMC1/16 330JATP	J24185330		1-	A	E1
R 1198	CHIP RES.	1k	1/16W	5%	RMC1/16 102JATP	J24185102		1-	A	E1
R 1199	CHIP RES.	100k	1/16W	5%	RMC1/16 104JATP	J24185104		1-	A	D3
R 1200	CHIP RES.	10k	1/16W	5%	RMC1/16 103JATP	J24185103		1-	A	B5
R 1201	CHIP RES.	1k	1/16W	5%	RMC1/16 102JATP	J24185102		1-	A	E1
R 1202	CHIP RES.	1k	1/16W	5%	RMC1/16 102JATP	J24185102		1-	A	E2
R 1203	CHIP RES.	100k	1/16W	5%	RMC1/16 104JATP	J24185104		1-	A	C3
R 1204	CHIP RES.	10k	1/16W	5%	RMC1/16 103JATP	J24185103		1-	A	B5
R 1205	CHIP RES.	1k	1/16W	5%	RMC1/16 102JATP	J24185102		1-	A	C2
R 1206	CHIP RES.	2.2k	1/16W	5%	RMC1/16 222JATP	J24185222		1-	A	C4
R 1207	CHIP RES.	10k	1/16W	5%	RMC1/16 103JATP	J24185103		1-	A	D5
R 1208	CHIP RES.	100k	1/16W	5%	RMC1/16 104JATP	J24185104		1-	A	C4
R 1209	CHIP RES.	33k	1/16W	5%	RMC1/16 333JATP	J24185333		1-	A	B5
R 1210	CHIP RES.	10	1/16W	5%	RMC1/16 100JATP	J24185100		1-	A	E1
R 1211	CHIP RES.	10	1/16W	5%	RMC1/16 100JATP	J24185100		1-	A	E1
R 1212	CHIP RES.	1k	1/16W	5%	RMC1/16 102JATP	J24185102		1-	A	E1
R 1213	CHIP RES.	1.5k	1/16W	5%	RMC1/16 152JATP	J24185152		1-	A	D3
R 1214	CHIP RES.	10k	1/16W	5%	RMC1/16 103JATP	J24185103		1-	A	C3
R 1215	CHIP RES.	470	1/16W	5%	RMC1/16 471JATP	J24185471		1-	A	C2
R 1216	CHIP RES.	330	1/16W	5%	RMC1/16 331JATP	J24185331		1-	A	E1
R 1217	CHIP RES.	18	1/16W	5%	RMC1/16 180JATP	J24185180		1-	A	E1
R 1218	CHIP RES.	10	1/16W	5%	RMC1/16 100JATP	J24185100		1-	A	E1
R 1219	CHIP RES.	1M	1/16W	5%	RMC1/16 105JATP	J24185105		1-	A	C3
R 1220	CHIP RES.	2.2k	1/16W	5%	RMC1/16 222JATP	J24185222		1-	A	C3
R 1221	CHIP RES.	47	1/16W	5%	RMC1/16 470JATP	J24185470		1-	A	D5
R 1222	CHIP RES.	47k	1/16W	1%	RMC1/16 473FTP	J24183473		1-	A	C4
R 1223	CHIP RES.	10k	1/16W	5%	RMC1/16 103JATP	J24185103		1-	A	C5
R 1224	CHIP RES.	10k	1/16W	5%	RMC1/16 103JATP	J24185103		1-	A	D4
R 1225	CHIP RES.	10k	1/16W	5%	RMC1/16 103JATP	J24185103		1-	A	B5
R 1226	CHIP RES.	10	1/16W	5%	RMC1/16 100JATP	J24185100		1-	A	E1
R 1227	CHIP RES.	330	1/16W	5%	RMC1/16 331JATP	J24185331		1-	A	E1
R 1228	CHIP RES.	15k	1/16W	5%	RMC1/16 153JATP	J24185153		1-	A	E6
R 1229	CHIP RES.	560	1/16W	5%	RMC1/16 561JATP	J24185561		1-	A	D4
R 1230	CHIP RES.	10k	1/16W	5%	RMC1/16 103JATP	J24185103		1-	A	B4
R 1231	CHIP RES.	100k	1/16W	5%	RMC1/16 104JATP	J24185104		1-	A	E5
R 1232	CHIP RES.	22k	1/16W	5%	RMC1/16 223JATP	J24185223		1-	A	E5
R 1233	CHIP RES.	68k	1/16W	5%	RMC1/16 683JATP	J24185683		1-	A	B5
R 1234	CHIP RES.	100k	1/16W	5%	RMC1/16 104JATP	J24185104		1-	A	B5
R 1235	CHIP RES.	10	1/16W	5%	RMC1/16 100JATP	J24185100		1-	A	B2
R 1236	CHIP RES.	180	1/16W	5%	RMC1/16 181JATP	J24185181		1-	A	D3
R 1237	CHIP RES.	3.3k	1/16W	5%	RMC1/16 332JATP	J24185332		1-	A	C3
R 1238	CHIP RES.	47k	1/16W	1%	RMC1/16 473FTP	J24183473		1-	A	C4
R 1239	CHIP RES.	100k	1/16W	1%	RMC1/16 104FTP	J24183104		1-	A	C4
R 1240	CHIP RES.	330k	1/16W	5%	RMC1/16 334JATP	J24185334		1-	A	B4
R 1241	CHIP RES.	22k	1/16W	5%	RMC1/16 223JATP	J24185223		1-	A	E5
R 1242	CHIP RES.	12k	1/16W	5%	RMC1/16 123JATP	J24185123		1-	A	D5
R 1243	CHIP RES.	1.5k	1/16W	5%	RMC1/16 152JATP	J24185152		1-	A	D3
R 1244	CHIP RES.	470	1/16W	5%	RMC1/16 471JATP	J24185471		1-	A	B2
R 1245	CHIP RES.	470	1/16W	5%	RMC1/16 471JATP	J24185471		1-	A	B2
R 1246	CHIP RES.	2.2k	1/16W	1%	RMC1/16 222FTP	J24183222		1-	A	B5
R 1247	CHIP RES.	100k	1/16W	1%	RMC1/16 104FTP	J24183104		1-	A	C4
R 1248	CHIP RES.	12k	1/16W	5%	RMC1/16 123JATP	J24185123		1-	A	D5
R 1249	CHIP RES.	560	1/16W	5%	RMC1/16 561JATP	J24185561		1-	A	D3
R 1250	CHIP RES.	1k	1/16W	5%	RMC1/16 102JATP	J24185102		1-	A	D3
R 1251	CHIP RES.	6.8k	1/16W	5%	RMC1/16 682JATP	J24185682		1-	A	C4
R 1252	CHIP RES.	4.7k	1/16W	5%	RMC1/16 472JATP	J24185472		1-	A	C4
R 1253	CHIP RES.	100k	1/16W	5%	RMC1/16 104JATP	J24185104		1-	A	B3
R 1254	CHIP CAP.	0.1uF	16V	B	GRM188B11C104KA01D	K22124805		1-5	A	C5
R 1255	CHIP RES.	2.2k	1/16W	1%	RMC1/16 222FTP	J24183222		1-	A	B5
R 1256	CHIP RES.	15k	1/16W	5%	RMC1/16 153JATP	J24185153		1-	A	B4
R 1257	CHIP RES.	6.8k	1/16W	5%	RMC1/16 682JATP	J24185682		1-	A	C4
R 1258	CHIP RES.	390	1/16W	5%	RMC1/16 391JATP	J24185391		1-	A	E2
R 1259	CHIP RES.	100	1/16W	5%	RMC1/16 101JATP	J24185101		1-	A	F2
R 1262	CHIP RES.	4.7k	1/16W	5%	RMC1/16 472JATP	J24185472		1-	A	C4
R 1263	CHIP RES.	100	1/16W	5%	RMC1/16 101JATP	J24185101		1-	A	E1
R 1264	CHIP RES.	22k	1/16W	5%	RMC1/16 223JATP	J24185223		1-	A	E5
R 1265	CHIP RES.	1k	1/16W	5%	RMC1/16 102JATP	J24185102		1-	A	E3
R 1266	CHIP RES.	100k	1/16W	5%	RMC1/16 104JATP	J24185104		1-	A	E5
R 1267	CHIP RES.	22k	1/16W	5%	RMC1/16 223JATP	J24185223		1-	A	C4
R 1268	CHIP RES.	100k	1/16W	5%	RMC1/16 104JATP	J24185104		1-	A	C5
R 1269	CHIP RES.	100k	1/16W	5%	RMC1/16 104JATP	J24185104		1-	A	C3

MAIN Unit

Parts List

REF	DESCRIPTION	VALUE	V/W	TOL.	MFR'S DESIG	VXSTD P/N	VERS.	LOT	SIDE	LAY ADR
R 1270	CHIP RES.	100	1/16W	5%	RMC1/16 101JATP	J24185101		1-	A	E2
R 1271	CHIP RES.	3.3k	1/16W	5%	RMC1/16 332JATP	J24185332		1-	A	E5
R 1272	CHIP RES.	100	1/16W	5%	RMC1/16 101JATP	J24185101		1-	A	E2
R 1273	CHIP RES.	47k	1/16W	5%	RMC1/16 473JATP	J24185473		1-	A	E5
R 1274	CHIP RES.	33k	1/16W	5%	RMC1/16 333JATP	J24185333		1-	A	C5
R 1275	CHIP RES.	100k	1/16W	5%	RMC1/16 104JATP	J24185104		1-	A	B6
R 1275	CHIP RES.	120k	1/16W	5%	RMC1/16 124JATP	J24185124		6-	A	B6
R 1276	CHIP RES.	100k	1/16W	5%	RMC1/16 104JATP	J24185104		1-	A	B6
R 1276	CHIP RES.	120k	1/16W	5%	RMC1/16 124JATP	J24185124		6-	A	B6
R 1277	CHIP RES.	47	1/16W	5%	RMC1/16 470JATP	J24185470		1-	A	D3
R 1278	CHIP RES.	470	1/16W	5%	RMC1/16 471JATP	J24185471		1-	A	C6
R 1279	CHIP RES.	100k	1/16W	5%	RMC1/16 104JATP	J24185104		1-	A	E6
R 1280	CHIP RES.	3.3k	1/16W	5%	RMC1/16 332JATP	J24185332		1-	A	D4
R 1281	CHIP RES.	470	1/16W	5%	RMC1/16 471JATP	J24185471		1-	A	B6
R 1282	CHIP RES.	68k	1/16W	5%	RMC1/16 683JATP	J24185683		1-	A	E5
R 1283	CHIP RES.	470	1/16W	5%	RMC1/16 471JATP	J24185471		1-	A	B6
R 1284	CHIP RES.	10k	1/16W	5%	RMC1/16 103JATP	J24185103		1-	A	D3
R 1285	CHIP RES.	6.8k	1/16W	5%	RMC1/16 682JATP	J24185682		1-	A	C4
R 1286	CHIP RES.	10k	1/16W	5%	RMC1/16 103JATP	J24185103		1-	A	B6
R 1287	CHIP RES.	150k	1/16W	5%	RMC1/16 154JATP	J24185154		1-	A	E6
R 1288	CHIP RES.	100k	1/16W	5%	RMC1/16 104JATP	J24185104		1-	A	C5
R 1289	CHIP RES.	10k	1/16W	5%	RMC1/16 103JATP	J24185103		1-	A	B6
R 1290	CHIP RES.	150	1/16W	5%	RMC1/16 151JATP	J24185151		1	A	E2
R 1290	CHIP RES.	33	1/16W	5%	RMC1/16 330JATP	J24185330		2-	A	E2
R 1291	CHIP RES.	150	1/16W	5%	RMC1/16 151JATP	J24185151		1	A	E2
R 1291	CHIP RES.	33	1/16W	5%	RMC1/16 330JATP	J24185330		2-	A	E2
R 1292	CHIP RES.	68k	1/16W	5%	RMC1/16 683JATP	J24185683		1-	A	E5
R 1293	CHIP RES.	47k	1/16W	5%	RMC1/16 473JATP	J24185473		1-	A	E5
R 1294	CHIP RES.	47k	1/16W	5%	RMC1/16 473JATP	J24185473		1-	A	C5
R 1295	CHIP RES.	100	1/16W	5%	RMC1/16 101JATP	J24185101		1-	A	D3
R 1296	CHIP RES.	470	1/16W	5%	RMC1/16 471JATP	J24185471		1-	A	E2
R 1297	CHIP RES.	100k	1/16W	5%	RMC1/16 104JATP	J24185104		1-	A	C5
R 1298	CHIP RES.	100k	1/16W	5%	RMC1/16 104JATP	J24185104		1-	A	C5
R 1299	CHIP RES.	1.5k	1/16W	5%	RMC1/16 152JATP	J24185152		1-	A	D4
R 1300	CHIP RES.	10k	1/16W	5%	RMC1/16 103JATP	J24185103		1-	A	C5
R 1301	CHIP RES.	4.7k	1/16W	5%	RMC1/16 472JATP	J24185472		1-	A	B6
R 1302	CHIP RES.	10k	1/16W	5%	RMC1/16 103JATP	J24185103		1-	A	D4
R 1303	CHIP RES.	10	1/16W	5%	RMC1/16 100JATP	J24185100		1-	A	F2
R 1304	CHIP RES.	4.7k	1/16W	5%	RMC1/16 472JATP	J24185472		1-	A	E1
R 1305	CHIP RES.	100k	1/16W	5%	RMC1/16 104JATP	J24185104		1-	A	C5
R 1306	CHIP RES.	100	1/16W	5%	RMC1/16 101JATP	J24185101		1-	A	E5
R 1307	CHIP RES.	1k	1/16W	5%	RMC1/16 102JATP	J24185102		1-	A	E6
R 1308	CHIP RES.	100k	1/16W	5%	RMC1/16 104JATP	J24185104		1-	A	E5
R 1309	CHIP RES.	1.5k	1/16W	5%	RMC1/16 152JATP	J24185152		1-	A	E4
R 1310	CHIP RES.	1k	1/16W	5%	RMC1/16 102JATP	J24185102		1-	A	E2
R 1311	CHIP RES.	47	1/16W	5%	RMC1/16 470JATP	J24185470		1-	A	E5
R 1312	CHIP RES.	18k	1/16W	5%	RMC1/16 183JATP	J24185183		1-	A	B6
R 1313	CHIP RES.	18k	1/16W	5%	RMC1/16 183JATP	J24185183		1-	A	B6
R 1314	CHIP RES.	33k	1/16W	5%	RMC1/16 333JATP	J24185333		1-	A	B5
R 1315	CHIP RES.	33k	1/16W	5%	RMC1/16 333JATP	J24185333		1-	A	B5
R 1316	CHIP RES.	10k	1/16W	5%	RMC1/16 103JATP	J24185103		1-	A	F6
R 1317	CHIP RES.	1k	1/16W	5%	RMC1/16 102JATP	J24185102		1-	A	C6
R 1318	CHIP RES.	10	1/16W	5%	RMC1/16 100JATP	J24185100		1	A	E3
R 1318	CHIP RES.	4.7	1/16W	5%	RMC1/16 4R7JATP	J24185479		2-	A	E3
R 1320	CHIP RES.	2.2k	1/16W	5%	RMC1/16 222JATP	J24185222		1-	A	E5
R 1322	CHIP RES.	47	1/16W	5%	RMC1/16 470JATP	J24185470		1-	A	A5
R 1323	CHIP RES.	10k	1/16W	5%	RMC1/16 103JATP	J24185103		1-	A	C5
R 1324	CHIP RES.	3.9k	1/16W	5%	RMC1/16 392JATP	J24185392		1-5	A	F2
R 1325	CHIP RES.	3.9k	1/16W	5%	RMC1/16 392JATP	J24185392		1-5	A	F2
R 1326	CHIP RES.	1k	1/16W	5%	RMC1/16 102JATP	J24185102		1-	A	E5
R 1327	CHIP RES.	33k	1/16W	5%	RMC1/16 333JATP	J24185333		1-	A	B6
R 1328	CHIP RES.	33k	1/16W	5%	RMC1/16 333JATP	J24185333		1-	A	B5
R 1329	CHIP RES.	68k	1/16W	5%	RMC1/16 683JATP	J24185683		1-	A	B5
R 1330	CHIP RES.	33k	1/16W	5%	RMC1/16 333JATP	J24185333		1-	A	B5
R 1331	CHIP RES.	68k	1/16W	5%	RMC1/16 683JATP	J24185683		1-	A	B5
R 1332	CHIP RES.	33k	1/16W	5%	RMC1/16 333JATP	J24185333		1-	A	B5
R 1333	CHIP RES.	100	1/16W	5%	RMC1/16 101JATP	J24185101		1-	A	F5
R 1334	CHIP RES.	1k	1/16W	5%	RMC1/16 102JATP	J24185102		1-	A	C6
R 1335	CHIP RES.	10k	1/16W	5%	RMC1/16 103JATP	J24185103		1-	A	D1
R 1337	CHIP RES.	100	1/16W	5%	RMC1/16 101JATP	J24185101		1-	A	E3
R 1338	CHIP RES.	4.7k	1/16W	5%	RMC1/16 472JATP	J24185472		1-	A	A5
R 1339	CHIP RES.	15k	1/16W	5%	RMC1/16 153JATP	J24185153		1-	A	E6
R 1340	CHIP RES.	2.2k	1/16W	5%	RMC1/16 222JATP	J24185222		1-	A	E5

MAIN Unit

Parts List

REF	DESCRIPTION	VALUE	V/W	TOL.	MFR'S DESIG	VXSTD P/N	VERS.	LOT	SIDE	LAY ADR
R 1341	CHIP RES.	47	1/16W	5%	RMC1/16 470JATP	J24185470		1-	A	E3
R 1342	CHIP RES.	10k	1/16W	5%	RMC1/16 103JATP	J24185103		1-	A	E3
R 1343	CHIP RES.	3.3k	1/16W	5%	RMC1/16 332JATP	J24185332		1-	A	E4
R 1345	CHIP RES.	220k	1/16W	5%	RMC1/16 224JATP	J24185224		1-	A	B5
R 1347	CHIP RES.	47k	1/16W	5%	RMC1/16 473JATP	J24185473		1-	A	C5
R 1348	CHIP RES.	33k	1/16W	5%	RMC1/16 333JATP	J24185333		1-	A	D5
R 1349	CHIP RES.	47k	1/16W	5%	RMC1/16 473JATP	J24185473		1-	A	C5
R 1350	CHIP RES.	33k	1/16W	5%	RMC1/16 333JATP	J24185333		1-	A	C5
R 1351	CHIP RES.	470	1/16W	5%	RMC1/16 471JATP	J24185471		1-	A	F5
R 1352	CHIP RES.	47	1/16W	5%	RMC1/16 470JATP	J24185470		1-	A	E4
R 1353	CHIP RES.	10	1/16W	5%	RMC1/16 100JATP	J24185100		1-	A	D1
R 1355	CHIP RES.	10	1/16W	5%	RMC1/16 100JATP	J24185100		1-	A	E5
R 1356	CHIP RES.	220k	1/16W	5%	RMC1/16 224JATP	J24185224		1-	A	B5
R 1357	CHIP RES.	150k	1/16W	5%	RMC1/16 154JATP	J24185154		1-	A	F5
R 1358	CHIP RES.	820	1/16W	5%	RMC1/16 821JATP	J24185821		1-	A	D5
R 1359	CHIP RES.	1.2k	1/16W	5%	RMC1/16 122JATP	J24185122		1-	A	D5
R 1360	CHIP RES.	33k	1/16W	5%	RMC1/16 333JATP	J24185333		1-	A	D5
R 1362	CHIP RES.	10k	1/16W	5%	RMC1/16 103JATP	J24185103		1-	A	B5
R 1363	CHIP RES.	33k	1/16W	5%	RMC1/16 333JATP	J24185333		1-	A	C5
R 1364	CHIP RES.	4.7k	1/16W	5%	RMC1/16 472JATP	J24185472		1-	A	B5
R 1365	CHIP RES.	680	1/16W	5%	RMC1/16 681JATP	J24185681		1-	A	F5
R 1366	CHIP RES.	4.7k	1/16W	5%	RMC1/16 472JATP	J24185472		1-	A	B5
R 1367	CHIP RES.	820	1/16W	5%	RMC1/16 821JATP	J24185821		1-	A	D5
R 1368	CHIP RES.	10k	1/16W	5%	RMC1/16 103JATP	J24185103		1-	A	B5
R 1369	CHIP RES.	100	1/16W	5%	RMC1/16 101JATP	J24185101		1-	A	F5
R 1370	CHIP RES.	10	1/16W	5%	RMC1/16 100JATP	J24185100		1-	A	D2
R 1371	CHIP RES.	3.3k	1/16W	5%	RMC1/16 332JATP	J24185332		1-	A	B5
R 1372	CHIP RES.	3.3k	1/16W	5%	RMC1/16 332JATP	J24185332		1-	A	A5
R 1373	CHIP RES.	100	1/16W	5%	RMC1/16 101JATP	J24185101		1-	A	E3
R 1374	CHIP RES.	10k	1/16W	5%	RMC1/16 103JATP	J24185103		1-	A	C5
R 1375	CHIP RES.	10k	1/16W	5%	RMC1/16 103JATP	J24185103		1-	A	A5
R 1376	CHIP RES.	15k	1/16W	5%	RMC1/16 153JATP	J24185153		1-	A	F5
R 1378	CHIP RES.	10k	1/16W	5%	RMC1/16 103JATP	J24185103		1-	A	D5
R 1379	CHIP RES.	1k	1/16W	5%	RMC1/16 102JATP	J24185102		1-	A	F6
R 1380	CHIP RES.	220	1/16W	5%	RMC1/16 221JATP	J24185221		1-	A	E4
R 1381	CHIP RES.	22k	1/16W	5%	RMC1/16 223JATP	J24185223		1-	A	B5
R 1382	CHIP RES.	470	1/16W	5%	RMC1/16 471JATP	J24185471		1-	A	B5
R 1383	CHIP RES.	100	1/10W	5%	RMC1/10T 101J	J24205101		1-	A	D1
R 1384	CHIP RES.	10	1/16W	5%	RMC1/16 100JATP	J24185100		1-	A	D5
R 1385	CHIP RES.	10k	1/16W	5%	RMC1/16 103JATP	J24185103		1-	A	C5
R 1386	CHIP RES.	22k	1/16W	5%	RMC1/16 223JATP	J24185223		1-	A	B5
R 1387	CHIP RES.	47	1/16W	5%	RMC1/16 470JATP	J24185470		1-	A	B5
R 1388	CHIP RES.	100	1/16W	5%	RMC1/16 101JATP	J24185101		1-	A	F4
R 1389	CHIP RES.	33k	1/16W	5%	RMC1/16 333JATP	J24185333		1-	A	C5
R 1390	CHIP RES.	1k	1/16W	5%	RMC1/16 102JATP	J24185102		1-	A	D1
R 1391	CHIP RES.	47k	1/16W	5%	RMC1/16 473JATP	J24185473		1-	A	E4
R 1392	CHIP RES.	470	1/16W	5%	RMC1/16 471JATP	J24185471		1-	A	F5
R 1393	CHIP RES.	22k	1/16W	5%	RMC1/16 223JATP	J24185223		1-	A	B5
R 1394	CHIP RES.	1k	1/16W	5%	RMC1/16 102JATP	J24185102		1-	A	F6
R 1395	CHIP RES.	470	1/16W	5%	RMC1/16 471JATP	J24185471		1-	A	D1
R 1396	CHIP RES.	33k	1/16W	5%	RMC1/16 333JATP	J24185333		1-	A	D5
R 1397	CHIP RES.	470	1/16W	5%	RMC1/16 471JATP	J24185471		1-	A	F6
R 1398	CHIP RES.	47k	1/16W	5%	RMC1/16 473JATP	J24185473		1-	A	D4
R 1399	CHIP RES.	22k	1/16W	5%	RMC1/16 223JATP	J24185223		1-	A	B5
R 1400	CHIP RES.	10	1/4W	5%	RMC1/4 100JATP	J24245100		1-	A	B5
R 1401	CHIP RES.	150k	1/16W	5%	RMC1/16 154JATP	J24185154		1-	A	F5
R 1402	CHIP RES.	470	1/16W	5%	RMC1/16 471JATP	J24185471		1-	A	F6
R 1403	CHIP RES.	1	1W	5%	RMC1 1R0JTE	J24305010		1-	A	A5
R 1404	CHIP RES.	2.2k	1/16W	5%	RMC1/16 222JATP	J24185222		1-	A	D1
R 1405	CHIP RES.	10k	1/16W	5%	RMC1/16 103JATP	J24185103		1-	A	D5
R 1407	CHIP RES.	8.2k	1/16W	5%	RMC1/16 822JATP	J24185822		1-	A	E5
R 1408	CHIP RES.	470	1/16W	5%	RMC1/16 471JATP	J24185471		1-	A	F6
R 1409	CHIP RES.	100k	1/16W	5%	RMC1/16 104JATP	J24185104		1-	A	C4
R 1410	CHIP RES.	470	1/16W	5%	RMC1/16 471JATP	J24185471		1-	A	E4
R 1411	CHIP RES.	220	1/16W	5%	RMC1/16 221JATP	J24185221		1-	A	D5
R 1412	CHIP RES.	8.2k	1/16W	5%	RMC1/16 822JATP	J24185822		1-	A	E5
R 1413	CHIP RES.	33	1/16W	5%	RMC1/16 330JATP	J24185330		1-	A	F5
R 1414	CHIP RES.	18k	1/16W	5%	RMC1/16 183JATP	J24185183		1-	A	C4
R 1415	CHIP RES.	10k	1/16W	5%	RMC1/16 103JATP	J24185103		1-	A	A6
R 1417	CHIP RES.	18k	1/16W	5%	RMC1/16 183JATP	J24185183		1-	A	C4
R 1418	CHIP RES.	1k	1/16W	5%	RMC1/16 102JATP	J24185102		1-	A	E6
R 1419	CHIP RES.	33k	1/16W	5%	RMC1/16 333JATP	J24185333		1-	A	D1
R 1420	CHIP RES.	10k	1/16W	5%	RMC1/16 103JATP	J24185103		1-	A	C4

MAIN Unit

Parts List

REF	DESCRIPTION	VALUE	V/W	TOL.	MFR'S DESIG	VXSTD P/N	VERS.	LOT	SIDE	LAY ADR
R 1421	CHIP RES.	10k	1/16W	5%	RMC1/16 103JATP	J24185103		1-	A	F5
R 1422	CHIP RES.	10	1/16W	5%	RMC1/16 100JATP	J24185100		1-	A	E4
R 1423	CHIP RES.	3.9k	1/16W	5%	RMC1/16 392JATP	J24185392		1-	A	F5
R 1424	CHIP RES.	8.2k	1/16W	5%	RMC1/16 822JATP	J24185822		1-	A	F5
R 1425	CHIP RES.	330	1/16W	5%	RMC1/16 331JATP	J24185331		1-	A	F5
R 1426	CHIP RES.	330	1/16W	5%	RMC1/16 331JATP	J24185331		1-	A	F5
R 1427	CHIP RES.	47	1/16W	5%	RMC1/16 470JATP	J24185470		1-	A	D4
R 1428	CHIP RES.	100	1/16W	5%	RMC1/16 101JATP	J24185101		1-	A	A5
R 1429	CHIP RES.	10k	1/16W	5%	RMC1/16 103JATP	J24185103		1-	A	E6
R 1430	CHIP RES.	10k	1/16W	5%	RMC1/16 103JATP	J24185103		1-	A	A6
R 1431	CHIP RES.	100k	1/16W	5%	RMC1/16 104JATP	J24185104		1-	A	C4
R 1432	CHIP RES.	33k	1/16W	5%	RMC1/16 333JATP	J24185333		1-	A	E4
R 1433	CHIP RES.	10k	1/16W	5%	RMC1/16 103JATP	J24185103		1-	A	E4
R 1434	CHIP RES.	100k	1/16W	5%	RMC1/16 104JATP	J24185104		1-	A	C4
R 1435	CHIP RES.	10k	1/16W	5%	RMC1/16 103JATP	J24185103		1-	A	D6
R 1436	CHIP RES.	100k	1/16W	5%	RMC1/16 104JATP	J24185104		1-	A	C5
R 1437	CHIP RES.	150k	1/16W	5%	RMC1/16 154JATP	J24185154		1-	A	E4
R 1438	CHIP RES.	330	1/16W	5%	RMC1/16 331JATP	J24185331		1-	A	D1
R 1439	CHIP RES.	220	1/16W	5%	RMC1/16 221JATP	J24185221		1-	A	E4
R 1439	CHIP RES.	330	1/16W	5%	RMC1/16 331JATP	J24185331		3-	A	E4
R 1439	CHIP RES.	220	1/16W	5%	RMC1/16 221JATP	J24185221		5-	A	E4
R 1441	CHIP RES.	18	1/16W	5%	RMC1/16 180JATP	J24185180		1-	A	D1
R 1442	CHIP RES.	470	1/16W	5%	RMC1/16 471JATP	J24185471		1-	A	G6
R 1443	CHIP RES.	100k	1/16W	5%	RMC1/16 104JATP	J24185104		1-	A	C5
R 1444	CHIP RES.	47	1/16W	5%	RMC1/16 470JATP	J24185470		1-	A	A6
R 1445	CHIP RES.	330	1/10W	5%	RMC1/10T 331J	J24205331		1-	A	B5
R 1446	CHIP RES.	220k	1/16W	5%	RMC1/16 224JATP	J24185224		1-	A	E4
R 1447	CHIP RES.	100	1/16W	5%	RMC1/16 101JATP	J24185101		1-	A	D5
R 1448	CHIP RES.	22k	1/16W	5%	RMC1/16 223JATP	J24185223		1-	A	F5
R 1449	CHIP RES.	470	1/16W	5%	RMC1/16 471JATP	J24185471		1-	A	G6
R 1450	CHIP RES.	100k	1/16W	5%	RMC1/16 104JATP	J24185104		1-	A	C4
R 1451	CHIP RES.	0	1/16W	5%	RMC1/16 000JATP	J24185000		1-	A	D5
R 1452	CHIP RES.	330	1/16W	5%	RMC1/16 331JATP	J24185331		1-	A	D1
R 1453	CHIP RES.	470	1/16W	5%	RMC1/16 471JATP	J24185471		1-	A	G6
R 1454	CHIP RES.	100	1/16W	5%	RMC1/16 101JATP	J24185101		1-	A	E3
R 1455	CHIP RES.	22k	1/16W	5%	RMC1/16 223JATP	J24185223		1-	A	D5
R 1456	CHIP RES.	2.2k	1/16W	5%	RMC1/16 222JATP	J24185222		1-	A	C4
R 1457	CHIP RES.	330	1/4W	5%	RMC1/4 331JATP	J24245331		1-	A	A6
R 1458	CHIP RES.	1k	1/16W	5%	RMC1/16 102JATP	J24185102		1-	A	F4
R 1459	CHIP RES.	330	1/10W	5%	RMC1/10T 331J	J24205331		1-	A	B5
R 1461	CHIP RES.	220k	1/16W	5%	RMC1/16 224JATP	J24185224		1-	A	F5
R 1462	CHIP RES.	10k	1/16W	5%	RMC1/16 103JATP	J24185103		1-	A	F5
R 1463	CHIP RES.	1k	1/16W	5%	RMC1/16 102JATP	J24185102		1-	A	D3
R 1464	CHIP RES.	22k	1/16W	5%	RMC1/16 223JATP	J24185223		1-	A	D4
R 1465	CHIP RES.	100	1/16W	5%	RMC1/16 101JATP	J24185101		1-	A	F4
R 1467	CHIP RES.	4.7k	1/16W	5%	RMC1/16 472JATP	J24185472		1-	A	F4
R 1468	CHIP RES.	220	1/16W	5%	RMC1/16 221JATP	J24185221		1-	A	A6
R 1469	CHIP RES.	1k	1/16W	5%	RMC1/16 102JATP	J24185102		1-	A	A6
R 1470	CHIP RES.	33	1/16W	5%	RMC1/16 330JATP	J24185330		1-	A	E3
R 1471	CHIP RES.	470	1/16W	5%	RMC1/16 471JATP	J24185471		1-	A	B3
R 1472	CHIP RES.	100	1/16W	5%	RMC1/16 101JATP	J24185101		1-	A	H2
R 1473	CHIP RES.	10	1/16W	5%	RMC1/16 100JATP	J24185100		1-	A	B5
R 1474	CHIP RES.	10	1/16W	5%	RMC1/16 100JATP	J24185100		1-	A	B5
R 1476	CHIP RES.	470	1/4W	5%	RMC1/4 471JATP	J24245471		1-	A	D4
R 1477	CHIP RES.	39	1/16W	5%	RMC1/16 390JATP	J24185390		1-	A	D4
R 1479	CHIP RES.	39k	1/16W	5%	RMC1/16 393JATP	J24185393		1-	A	F5
R 1480	CHIP RES.	56k	1/16W	1%	RMC1/16 563FTP	J24183563		1-	A	B4
R 1481	CHIP RES.	18k	1/16W	1%	RMC1/16 183FTP	J24183183		1-	A	B4
R 1482	CHIP RES.	56k	1/16W	1%	RMC1/16 563FTP	J24183563		1-	A	B4
R 1484	CHIP RES.	18k	1/16W	1%	RMC1/16 183FTP	J24183183		1-	A	B4
R 1485	CHIP RES.	100	1/10W	5%	RMC1/10T 101J	J24205101		1-	A	D1
R 1486	CHIP RES.	0	1/16W	5%	RMC1/16 000JATP	J24185000		1-	A	F4
R 1487	CHIP RES.	4.7k	1/16W	5%	RMC1/16 472JATP	J24185472		1-	A	D4
R 1490	CHIP RES.	0	1/16W	5%	RMC1/16 000JATP	J24185000		1-	A	E2
R 1491	CHIP RES.	100	1/16W	5%	RMC1/16 101JATP	J24185101		1-	A	E3
R 1492	CHIP RES.	100	1/16W	5%	RMC1/16 101JATP	J24185101		1-	A	E4
R 1493	CHIP RES.	0	1/16W	5%	RMC1/16 000JATP	J24185000		1-2	A	E3
R 1494	CHIP RES.	0	1/16W	5%	RMC1/16 000JATP	J24185000		1-	A	E4
R 1495	CHIP RES.	330k	1/16W	5%	RMC1/16 334JATP	J24185334		1-	A	F4
R 1497	CHIP RES.	0	1/16W	5%	RMC1/16 000JATP	J24185000		1-5	A	E3
R 1498	CHIP RES.	0	1/16W	5%	RMC1/16 000JATP	J24185000		1-5	A	E3
R 1503	CHIP RES.	100	1/4W	5%	RMC1/4 101JATP	J24245101		1-	A	A6
R 1504	CHIP RES.	3.3k	1/16W	5%	RMC1/16 332JATP	J24185332		1-	A	A5

MAIN Unit

Parts List

REF	DESCRIPTION	VALUE	V/W	TOL.	MFR'S DESIG	VXSTD P/N	VERS.	LOT	SIDE	LAY ADR
R 1505	CHIP RES.	18	1/16W	5%	RMC1/16 180JATP	J24185180		1-	A	E4
R 1505	CHIP RES.	47	1/16W	5%	RMC1/16 470JATP	J24185470		3-	A	E4
R 1505	CHIP RES.	68	1/16W	5%	RMC1/16 680JATP	J24185680		5-	A	E4
R 1506	CHIP RES.	270	1/16W	5%	RMC1/16 271JATP	J24185271		1-	A	E4
R 1506	CHIP RES.	120	1/16W	5%	RMC1/16 121JATP	J24185121		3-	A	E4
R 1506	CHIP RES.	100	1/16W	5%	RMC1/16 101JATP	J24185101		5-	A	E4
R 1507	CHIP RES.	270	1/16W	5%	RMC1/16 271JATP	J24185271		1-	A	E4
R 1507	CHIP RES.	120	1/16W	5%	RMC1/16 121JATP	J24185121		3-	A	E4
R 1507	CHIP RES.	100	1/16W	5%	RMC1/16 101JATP	J24185101		5-	A	E4
R 1508	CHIP RES.	100k	1/16W	5%	RMC1/16 104JATP	J24185104		1-	A	G6
R 1509	CARBON FILM RES.	1k	1/6W	5%	RD16TPJ102 1K	J07225102		1-		
R 1509	CHIP RES.	1k	1/16W	5%	RMC1/16 102JATP	J24185102		6-		
R 1510	CHIP RES.	1.2k	1/10W	5%	RMC1/10T 122J	J24205122		1-		
R 1510	CHIP RES.	1.2k	1/16W	5%	RMC1/16 122JATP	J24185122		6-		
R 1511	CHIP RES.	0	1/16W	5%	RMC1/16 000JATP	J24185000		6-		
R 1514	CHIP RES.	0	1/16W	5%	RMC1/16 000JATP	J24185000		6-		
RL1001	RELAY		DC12V		G6K-2F-Y-TR DC12V	M1190183		1-	A	C6
RL1002	RELAY		DC12V		G6K-2F-Y-TR DC12V	M1190183		1-	A	I6
RL1003	RELAY		DC12V		G6K-2F-Y-TR DC12V	M1190183		1-	A	A1
RL1004	RELAY		DC12V		G6K-2F-Y-TR DC12V	M1190183		1-	A	I6
RL1005	RELAY		DC12V		G6K-2F-Y-TR DC12V	M1190183		1-	A	H6
RL1006	RELAY		DC12V		G6K-2F-Y-TR DC12V	M1190183		1-	A	H6
RL1007	RELAY		DC12V		G6K-2F-Y-TR DC12V	M1190183		1-	A	G2
RL1008	RELAY		DC12V		G6K-2F-Y-TR DC12V	M1190183		1-	A	G1
RL1009	RELAY		DC12V		G6K-2F-Y-TR DC12V	M1190183		1-	A	H1
RL1010	RELAY		DC12V		G6K-2F-Y-TR DC12V	M1190183		1-	A	H1
RL1011	RELAY		DC12V		G6K-2F-Y-TR DC12V	M1190183		1-	A	G3
RL1012	RELAY		DC12V		G6K-2F-Y-TR DC12V	M1190183		1-	A	H2
RL1013	RELAY		DC12V		G6K-2F-Y-TR DC12V	M1190183		1-	A	H3
RL1014	RELAY		DC12V		G6K-2F-Y-TR DC12V	M1190183		1-	A	F1
RL1015	RELAY		DC12V		G6K-2F-Y-TR DC12V	M1190183		1-	A	G1
RL1016	RELAY		DC12V		G6K-2F-Y-TR DC12V	M1190183		1-	A	F1
RL1017	RELAY		DC12V		G6K-2F-Y-TR DC12V	M1190183		1-	A	F1
RL1018	RELAY		DC12V		G6K-2F-Y-TR DC12V	M1190183		1-	A	E1
RL1019	RELAY		DC12V		G6K-2F-Y-TR DC12V	M1190183		1-	A	E3
RL1020	RELAY		DC12V		G6K-2F-Y-TR DC12V	M1190183		1-	A	E4
RL1021	RELAY		DC12V		G6K-2F-Y-TR DC12V	M1190183		1-	A	B5
RL1022	RELAY		DC12V		AG4013 DC12V	M1190090		1-	A	A6
RL1023	RELAY		DC12V		G6K-2F-Y-TR DC12V	M1190183		1-	A	H3
RL1024	RELAY		DC12V		G6K-2F-Y-TR DC12V	M1190183		1-	A	E3
RL1024	RELAY		DC12V		G6K-2F-RF-TR03 DC12V	M1190196		6-	A	E3
RL1025	RELAY		DC12V		G6K-2F-Y-TR DC12V	M1190183		1-	A	E4
T 1001	BALUN TRANSFORMERS				#458PT-1565	L0190273		1-	A	B1
T 1002	BALUN TRANSFORMERS				#458PT-1565	L0190273		1-	A	C1
T 1003	COIL 07WIDE				4-1 2001F FR6	L0021351		1-	A	B1
T 1004	BALUN TRANSFORMERS				#458PT-1565	L0190273		1-	A	D2
T 1005	BALUN TRANSFORMERS				#458PT-1565	L0190273		1-	A	D2
T 1006	COIL 05RF				74.62M 010812302	L0022781		1-	A	D3
T 1007	COIL 05RF				74.62M 010812302	L0022781		1-	A	D3
T 1008	COIL WIDE-TRANS.				3-318707	L0022619		1-	A	E1
T 1009	COIL WIDE-TRANS.				3-318707	L0022619		1-	A	E1
T 1010	COIL 05RF				74.62M 010812302	L0022781		1-	A	D3
T 1011	COIL 05RF				100M 010812300A	L0022779		1-	A	E2
T 1012	BALUN TRANSFORMERS				#617DS-1710	L0190275		1-	A	E2
T 1013	COIL 07WIDE				4-1 2D3 TR6X3	L0020788A		1-	A	D5
T 1014	COIL 05RF				74.62M 010812302	L0022781		1-	A	D3
T 1015	BALUN TRANSFORMERS				#617DS-1710	L0190275		1-	A	D2
T 1016	BALUN TRANSFORMERS				#458PT-1565	L0190273		1-	A	E2
T 1017	COIL 07WIDE				4-1 2D3 TR6X3	L0020788A		1-	A	E5
T 1018	BALUN TRANSFORMERS				#458PT-1586	L0190276		1-	A	E2
T 1019	COIL 05RF	455kHz			455K 030812470	L0022778		1-	A	E5
T 1020	COIL 05RF				100M 010812300A	L0022779		1-	A	D4
T 1021	BALUN TRANSFORMERS				#458PT-1565	L0190273		1-	A	E3
T 1022	COIL 05RF	455kHz			455K 030812471	L0022780		1-	A	F5
T 1023	COIL 05RF	455kHz			455K 030812471	L0022780		1-	A	E5
T 1025	COIL 05RF	455kHz			455K 030812471	L0022780		1-	A	F5
T 1026	BALUN TRANSFORMERS				#458PT-1586	L0190276		1-	A	D2
T 1028	COIL 05RF	455kHz			455K 030812471	L0022780		1-	A	D5
T 1029	COIL 05RF	455kHz			455K 030812471	L0022780		1-	A	E4
T 1030	COIL 05RF				74.62M 010812302	L0022781		1-	A	F4
T 1031	COIL 05RF				100M 010812300A	L0022779		1-	A	F3
T 1032	COIL 05RF	455kHz			455K 060812596	L0022983		1-	A	F5
T 1033	COIL 05RF	455kHz			455K 030812471	L0022780		1-	A	D4

MAIN Unit

Parts List

REF	DESCRIPTION	VALUE	V/W	TOL.	MFR'S DESIG	VXSTD P/N	VERS.	LOT	SIDE	LAY ADR
T 1034	COIL 05RF				50M 010812304	L0022783		1-	A	E4
T 1035	COIL 05RF				74.62M 010812302	L0022781		1-	A	F4
T 1036	COIL 05RF				100M 010812300A	L0022779		1-	A	F4
T 1037	BALUN TRANSFORMERS				#458PT-1565	L0190273		1-	A	F4
T 1038	COIL 05RF				74.62M 010812302	L0022781		1-	A	F4
T 1039	COIL 05RF				74.62M 010812302	L0022781		1-	A	E3
T 1040	COIL 05RF				74.62M 010812302	L0022781		1-	A	E4
TC1001	TRIMMER CAP.	20pF			TZB4R200AA10R00	K91000217		1-	A	F3
TC1002	TRIMMER CAP.	20pF			TZB4R200AA10R00	K91000217		1-	A	E3
TP1001	CHECK TERMINAL				RCT00000C	Q5000103		1-	A	B1
TP1002	CHECK TERMINAL				RCT00000C	Q5000103		1-	A	A3
TP1003	CHECK TERMINAL				RCT00000C	Q5000103		1-	A	B1
TP1004	CHECK TERMINAL				RCT00000C	Q5000103		1-	A	B4
TP1008	CHECK TERMINAL				RCT00000C	Q5000103		1-	A	E4
TP1009	CHECK TERMINAL				RCT00000C	Q5000103		1-	A	C4
TP1010	CHECK TERMINAL				RCT00000C	Q5000103		1-	A	C4
TP1011	CHECK TERMINAL				RCT00000C	Q5000103		1-	A	C3
TP1012	CHECK TERMINAL				RCT00000C	Q5000103		1-	A	C4
TP1013	CHECK TERMINAL				RCT00000C	Q5000103		1-	A	E3
TP1014	CHECK TERMINAL				RCT00000C	Q5000103		1-	A	E2
TP1015	CHECK TERMINAL				RCT00000C	Q5000103		1-	A	C5
TP1016	CHECK TERMINAL				RCT00000C	Q5000103		1-	A	D5
TP1017	CHECK TERMINAL				RCT00000C	Q5000103		1-	A	E4
TP1018	CHECK TERMINAL				RCT00000C	Q5000103		1-	A	D5
TP1019	CHECK TERMINAL				RCT00000C	Q5000103		1-	A	E5
TP1020	CHECK TERMINAL				RCT00000C	Q5000103		1-	A	F5
TP1021	CHECK TERMINAL				RCT00000C	Q5000103		1-	A	E5
TP1022	CHECK TERMINAL				RCT00000C	Q5000103		1-	A	D5
XF1001	XTAL FILTER				MFT69Q2 69.450MHZ	H1102404		1-	A	D4
XF1002	XTAL FILTER				MFT69L2 69.450MHZ	H1102402		1-	A	E3
XF1003	XTAL FILTER				MFT69Q2 69.450MHZ	H1102404		1-	A	F3
XF1004	XTAL FILTER				MFT69G2 69.450MHZ	H1102407		1-	A	E3
	SHIELD CASE				(21X25)	RA0830300		1-		
	SHIELD CASE COVER				(21X25)	RA0830400		1-		
	SHIELD CASE				(20X51)	RA0830700		1-		
	SHIELD CASE COVER				(20X51)	RA0830800		1-		
	SHIELD CASE					RA0659300		1-		
	SHIELD CASE					RA0766800		2-5		

Provided by
 YAESU museum

 Downloaded by
 RadioAmateur.EU

MAIN Unit

VRF-UNIT BR014800A (2000-2399)

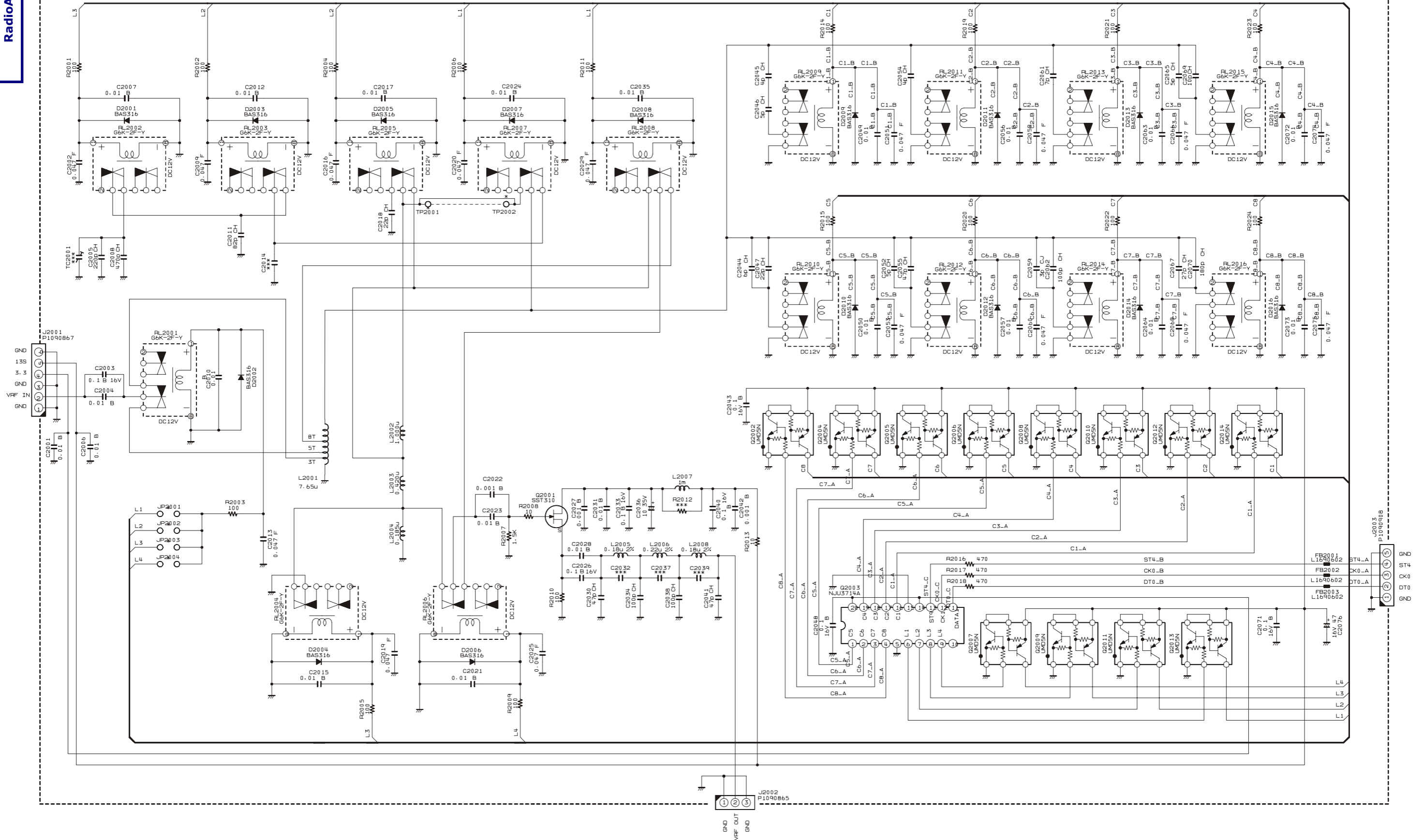

VRF Unit

Parts Layout

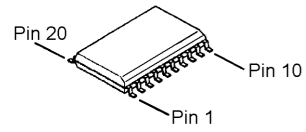

NJU3714A
(Q2003)

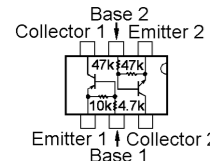

UMD5N
(Q2002, 2004, 2005,
2006, 2007, 2008,
2009, 2010, 2011,
2012, 2013, 2014)

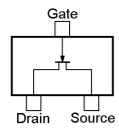

SST310 (Z0)
(Q2001)

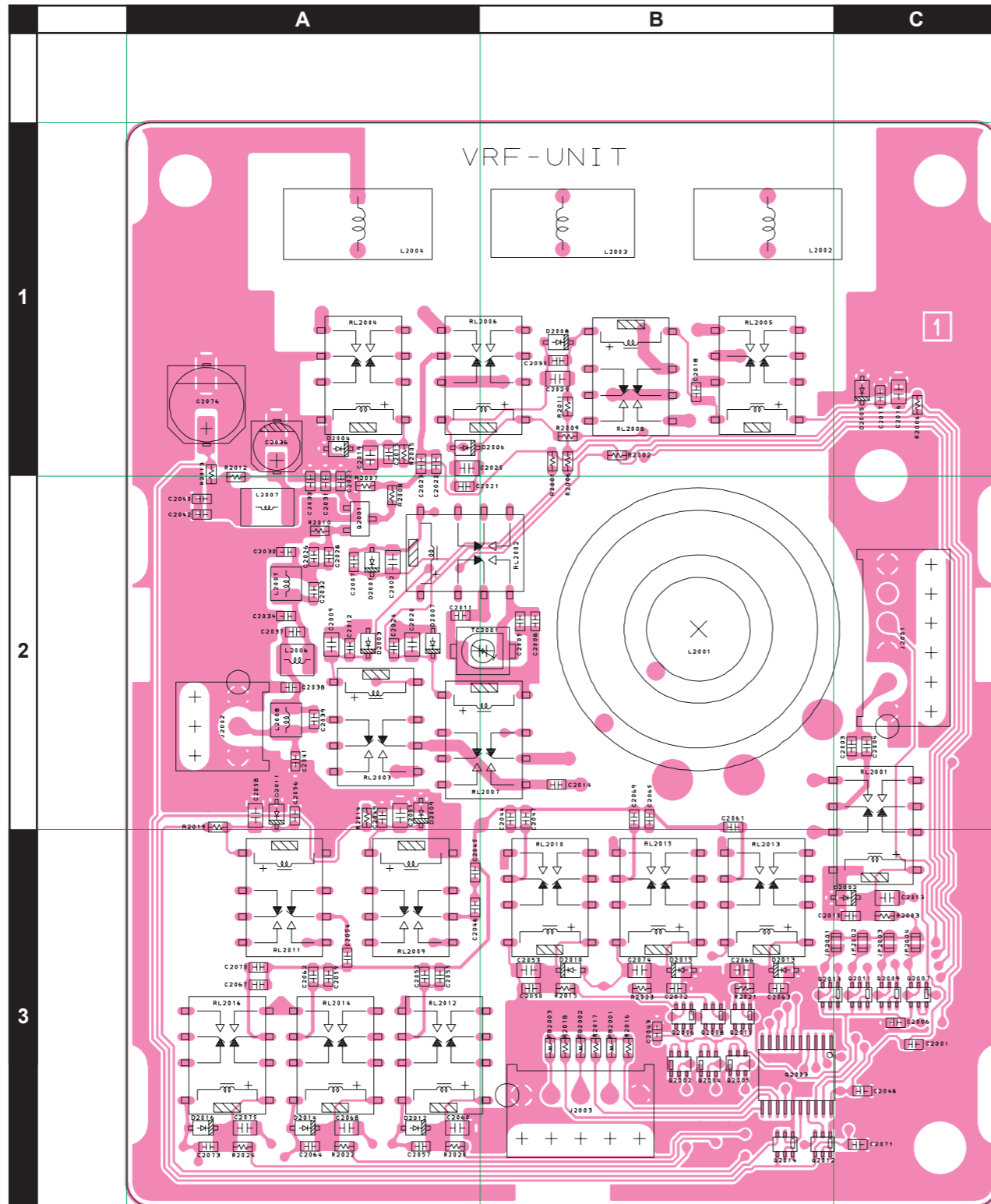

Side A

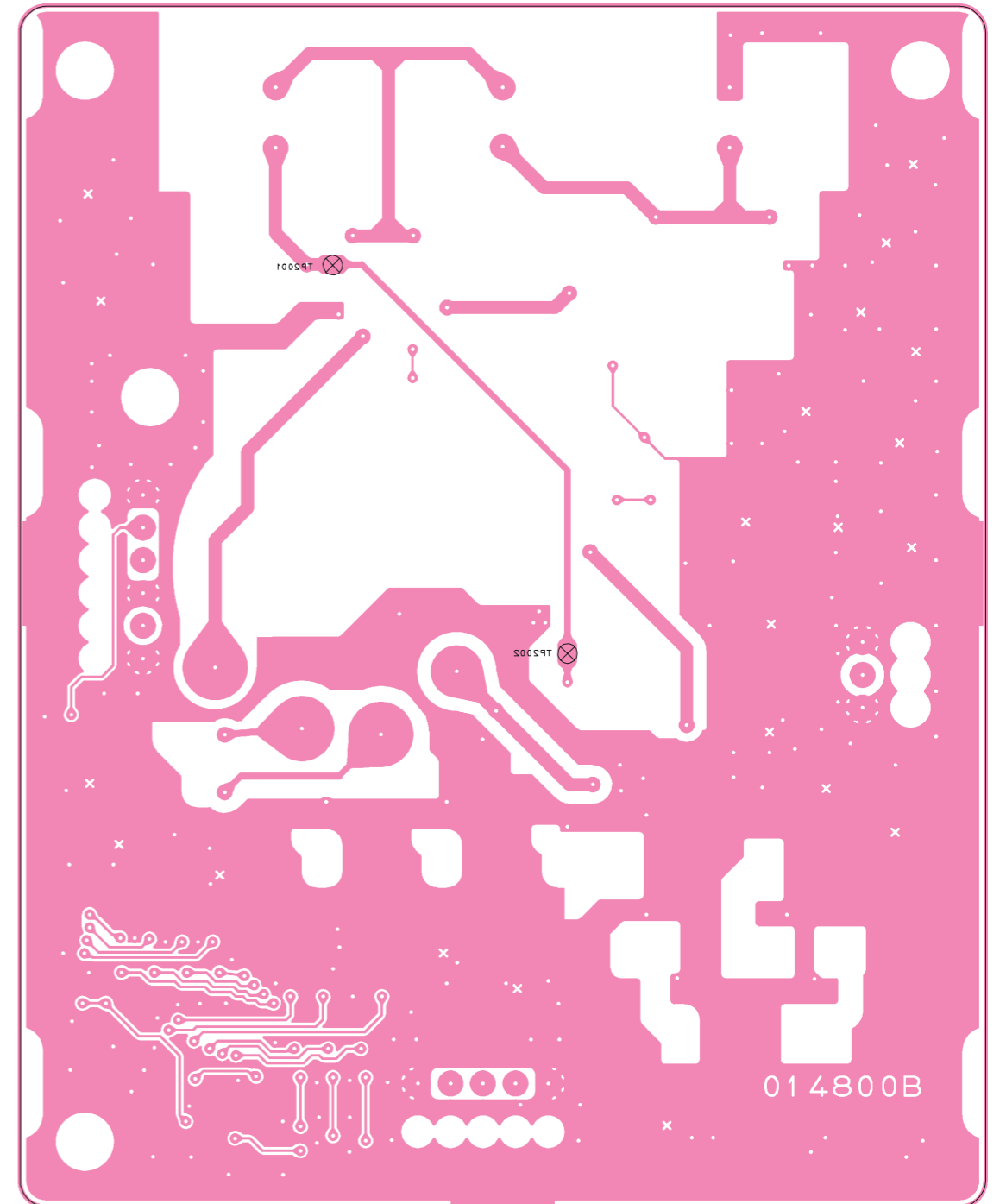

Side B

REF	DESCRIPTION	VALUE	V/W	TOL.	MFR'S DESIG	VXSTD P/N	VERS.	LOT	SIDE	LAY ADR	
PCB with Components						CB3549001					
Printed Circuit Board						AH025H000	FR0148000		1-		
C 2001	CHIP CAP.	0.01uF	50V	B	GRM188B11H103KA01D	K22174823		1-	A	C3	
C 2002	CHIP CAP.	0.047uF	50V	F	GRM40F473Z50PT	K22171008		1-	A	A2	
C 2003	CHIP CAP.	0.1uF	16V	B	GRM188B11C104KA01D	K22124805		1-	A	C2	
C 2004	CHIP CAP.	0.01uF	50V	B	GRM188B11H103KA01D	K22174823		1-	A	C2	
C 2005	CHIP CAP.	220pF	50V	CH	GRM1882C1H221JA01D	K22174243		1-	A	B2	
C 2005	CHIP CAP.	180pF	50V	CH	GRM1882C1H181JA01D	K22174241		6-	A	B2	
C 2006	CHIP CAP.	0.01uF	50V	B	GRM188B11H103KA01D	K22174823		1-	A	C3	
C 2007	CHIP CAP.	0.01uF	50V	B	GRM188B11H103KA01D	K22174823		1-	A	A2	
C 2008	CHIP CAP.	470pF	50V	CH	GRM1882C1H471JA01D	K22174249		1-	A	B2	
C 2009	CHIP CAP.	0.047uF	50V	F	GRM40F473Z50PT	K22171008		1-	A	A2	
C 2010	CHIP CAP.	0.01uF	50V	B	GRM188B11H103KA01D	K22174823		1-	A	C3	
C 2011	CHIP CAP.	82pF	50V	CH	GRM1882C1H820JA01D	K22174233		1-	A	A2	
C 2011	CHIP CAP.	100pF	50V	CH	GRM1882C1H101JA01D	K22174235		4-	A	A2	
C 2011	CHIP CAP.	82pF	50V	CH	GRM1882C1H820JA01D	K22174233		6-	A	A2	
C 2012	CHIP CAP.	0.01uF	50V	B	GRM188B11H103KA01D	K22174823		1-	A	A2	
C 2013	CHIP CAP.	0.047uF	50V	F	GRM40F473Z50PT	K22171008		1-	A	C3	
C 2015	CHIP CAP.	0.01uF	50V	B	GRM188B11H103KA01D	K22174823		1-	A	A1	
C 2016	CHIP CAP.	0.047uF	50V	F	GRM40F473Z50PT	K22171008		1-	A	C1	
C 2017	CHIP CAP.	0.01uF	50V	B	GRM188B11H103KA01D	K22174823		1-	A	C1	
C 2018	CHIP CAP.	22pF	50V	CH	GRM1882C1H220JA01D	K22174219		1-	A	B1	
C 2018	CHIP CAP.	27pF	50V	CH	GRM1882C1H270JA01D	K22174221		4-	A	B1	
C 2018	CHIP CAP.	22pF	50V	CH	GRM1882C1H220JA01D	K22174219		6-	A	B1	
C 2019	CHIP CAP.	0.047uF	50V	F	GRM40F473Z50PT	K22171008		1-	A	A1	
C 2020	CHIP CAP.	0.047uF	50V	F	GRM40F473Z50PT	K22171008		1-	A	A2	
C 2021	CHIP CAP.	0.01uF	50V	B	GRM188B11H103KA01D	K22174823		1-	A	A2	
C 2022	CHIP CAP.	0.001uF	50V	B	GRM188B11H102KA01D	K22174821		1-	A	A1	
C 2023	CHIP CAP.	0.01uF	50V	B	GRM188B11H103KA01D	K22174823		1-	A	A1	
C 2024	CHIP CAP.	0.01uF	50V	B	GRM188B11H103KA01D	K22174823		1-	A	A2	
C 2025	CHIP CAP.	0.047uF	50V	F	GRM40F473Z50PT	K22171008		1-	A	A1	
C 2026	CHIP CAP.	0.1uF	16V	B	GRM188B11C104KA01D	K22124805		1-	A	A2	
C 2027	CHIP CAP.	0.001uF	50V	B	GRM188B11H102KA01D	K22174821		1-	A	A2	
C 2028	CHIP CAP.	0.01uF	50V	B	GRM188B11H103KA01D	K22174823		1-	A	A2	
C 2029	CHIP CAP.	0.047uF	50V	F	GRM40F473Z50PT	K22171008		1-	A	B1	
C 2030	CHIP CAP.	47pF	50V	CH	GRM1882C1H470JA01D	K22174227		1-	A	A2	
C 2031	CHIP CAP.	0.01uF	50V	B	GRM188B11H103KA01D	K22174823		1-	A	A2	
C 2033	CHIP CAP.	0.1uF	16V	B	GRM188B11C104KA01D	K22124805		1-	A	A2	
C 2034	CHIP CAP.	100pF	50V	CH	GRM1882C1H101JA01D	K22174235		1-	A	A2	
C 2035	CHIP CAP.	0.01uF	50V	B	GRM188B11H103KA01D	K22174823		1-	A	B1	
C 2036	AL.ELECTRO.CAP.	10uF	35V		EEE1VA100WR	K48160006		1-	A	A1	
C 2038	CHIP CAP.	100pF	50V	CH	GRM1882C1H101JA01D	K22174235		1-	A	A2	
C 2040	CHIP CAP.	0.1uF	16V	B	GRM188B11C104KA01D	K22124805		1-	A	A2	
C 2041	CHIP CAP.	47pF	50V	CH	GRM1882C1H470JA01D	K22174227		1-	A	A2	
C 2042	CHIP CAP.	0.001uF	50V	B	GRM188B11H102KA01D	K22174821		1-	A	A2	
C 2043	CHIP CAP.	0.1uF	16V	B	GRM188B11C104KA01D	K22124805		1-	A	B3	
C 2044	CHIP CAP.	6pF	50V	CH	GRM1882C1H6R0DZ01D	K22174207		1-	A	B2	
C 2045	CHIP CAP.	4pF	50V	CH	GRM1882C1H4R0CZ01D	K22174205		1-	A	A3	
C 2046	CHIP CAP.	5pF	50V	CH	GRM1882C1H5R0CZ01D	K22174206		1-	A	A3	
C 2047	CHIP CAP.	22pF	50V	CH	GRM1882C1H220JA01D	K22174219		1-	A	B2	
C 2048	CHIP CAP.	0.1uF	16V	B	GRM188B11C104KA01D	K22124805		1-	A	C3	
C 2049	CHIP CAP.	0.01uF	50V	B	GRM188B11H103KA01D	K22174823		1-	A	A2	
C 2050	CHIP CAP.	0.01uF	50V	B	GRM188B11H103KA01D	K22174823		1-	A	B3	
C 2051	CHIP CAP.	0.047uF	50V	F	GRM40F473Z50PT	K22171008		1-	A	A2	
C 2052	CHIP CAP.	5pF	50V	CH	GRM1882C1H5R0CZ01D	K22174206		1-	A	A3	
C 2053	CHIP CAP.	0.047uF	50V	F	GRM40F473Z50PT	K22171008		1-	A	B3	
C 2054	CHIP CAP.	4pF	50V	CH	GRM1882C1H4R0CZ01D	K22174205		1-	A	A3	
C 2055	CHIP CAP.	47pF	50V	CH	GRM1882C1H470JA01D	K22174227		1-	A	A3	
C 2056	CHIP CAP.	0.01uF	50V	B	GRM188B11H103KA01D	K22174823		1-	A	A2	
C 2057	CHIP CAP.	0.01uF	50V	B	GRM188B11H103KA01D	K22174823		1-	A	A3	
C 2058	CHIP CAP.	0.047uF	50V	F	GRM40F473Z50PT	K22171008		1-	A	A2	
C 2059	CHIP CAP.	3pF	50V	CJ	GRM1883C1H3R0CZ01D	K22174204		1-	A	A3	
C 2060	CHIP CAP.	0.047uF	50V	F	GRM40F473Z50PT	K22171008		1-	A	A3	
C 2061	CHIP CAP.	7pF	50V	CH	GRM1882C1H7R0DZ01D	K22174208		1-	A	B2	
C 2062	CHIP CAP.	100pF	50V	CH	GRM1882C1H101JA01D	K22174235		1-	A	A3	
C 2063	CHIP CAP.	0.01uF	50V	B	GRM188B11H103KA01D	K22174823		1-	A	B3	
C 2064	CHIP CAP.	0.01uF	50V	B	GRM188B11H103KA01D	K22174823		1-	A	A3	
C 2065	CHIP CAP.	5pF	50V	CH	GRM1882C1H5R0CZ01D	K22174206		1-	A	B2	
C 2066	CHIP CAP.	0.047uF	50V	F	GRM40F473Z50PT	K22171008		1-	A	B3	
C 2067	CHIP CAP.	27pF	50V	CH	GRM1882C1H270JA01D	K22174221		1-	A	A3	
C 2067	CHIP CAP.	56pF	50V	CH	GRM1882C1H560JA01D	K22174229		4-	A	A3	
C 2067	CHIP CAP.	39pF	50V	CH	GRM1882C1H390JA01D	K22174225		6-	A	A3	
C 2068	CHIP CAP.	0.047uF	50V	F	GRM40F473Z50PT	K22171008		1-	A	A3	

VRF Unit

Parts List

REF	DESCRIPTION	VALUE	V/W	TOL.	MFR'S DESIG	VXSTD P/N	VERS.	LOT	SIDE	LAY ADR
C 2069	CHIP CAP.	10pF	50V	CH	GRM1882C1H100JA01D	K22174211		1-	A	B2
C 2070	CHIP CAP.	180pF	50V	CH	GRM1882C1H181JA01D	K22174241		1-	A	A3
C 2071	CHIP CAP.	0.1uF	16V	B	GRM188B11C104KA01D	K22124805		1-	A	C3
C 2072	CHIP CAP.	0.01uF	50V	B	GRM188B11H103KA01D	K22174823		1-	A	B3
C 2073	CHIP CAP.	0.01uF	50V	B	GRM188B11H103KA01D	K22174823		1-	A	A3
C 2074	CHIP CAP.	0.047uF	50V	F	GRM40F473Z50PT	K22171008		1-	A	B3
C 2075	CHIP CAP.	0.047uF	50V	F	GRM40F473Z50PT	K22171008		1-	A	A3
C 2076	AL.ELECTRO.CAP.	47uF	16V		EEE1CA470SP	K48120005		1-	A	A1
D 2001	DIODE				BAS316	G2070716		1-	A	A2
D 2002	DIODE				BAS316	G2070716		1-	A	C3
D 2003	DIODE				BAS316	G2070716		1-	A	A2
D 2004	DIODE				BAS316	G2070716		1-	A	A1
D 2005	DIODE				BAS316	G2070716		1-	A	C1
D 2006	DIODE				BAS316	G2070716		1-	A	A1
D 2007	DIODE				BAS316	G2070716		1-	A	A2
D 2008	DIODE				BAS316	G2070716		1-	A	B1
D 2009	DIODE				BAS316	G2070716		1-	A	A2
D 2010	DIODE				BAS316	G2070716		1-	A	B3
D 2011	DIODE				BAS316	G2070716		1-	A	A2
D 2012	DIODE				BAS316	G2070716		1-	A	A3
D 2013	DIODE				BAS316	G2070716		1-	A	B3
D 2014	DIODE				BAS316	G2070716		1-	A	A3
D 2015	DIODE				BAS316	G2070716		1-	A	B3
D 2016	DIODE				BAS316	G2070716		1-	A	A3
FB2001	CHIP COI				BLM18BD182SN1D	L1690602		1-	A	B3
FB2002	CHIP COI				BLM18BD182SN1D	L1690602		1-	A	B3
FB2003	CHIP COI				BLM18BD182SN1D	L1690602		1-	A	B3
J 2001	CONNECTOR				IMSA-9133S-06D	P1090867		1-	A	C2
J 2002	CONNECTOR				IMSA-9133S-03D	P1090865		1-	A	A2
J 2003	CONNECTOR				IMSA-9133S-05D	P1090908		1-	A	B3
L 2001	TOROIDAL COIL	7.65uH			7.65U T80-2	L0022848A		1-	A	B2
L 2002	TOROIDAL COIL	1uH			1.000U T37-6 AMIDON	L0021571		1-	A	B1
L 2003	TOROIDAL COIL	0.42uH			0.420U T37-6 AMIDON	L0021575B		1-	A	B1
L 2004	TOROIDAL COIL	0.185uH			0.185U T37-10	L0022981		1-	A	A1
L 2005	CHIP COIL	0.18uH		2%	C2520C-R18G	L1691297		1-	A	A2
L 2006	CHIP COIL	0.22uH		2%	C2520C-R22G	L1691298		1-	A	A2
L 2007	CHIP COIL	1mH			LQH43MN102K03L	L1690108		1-	A	A2
L 2008	CHIP COIL	0.18uH		2%	C2520C-R18G	L1691297		1-	A	A2
Q 2001	FET				SST310-T1	G4070009		1-	A	A2
Q 2002	TRANSISTOR				UMD5N TR	G3070343		1-	A	B3
Q 2003	IC				NJU3714A(TAPE)	G1094291		1-	A	B3
Q 2004	TRANSISTOR				UMD5N TR	G3070343		1-	A	B3
Q 2005	TRANSISTOR				UMD5N TR	G3070343		1-	A	B3
Q 2006	TRANSISTOR				UMD5N TR	G3070343		1-	A	B3
Q 2007	TRANSISTOR				UMD5N TR	G3070343		1-	A	C3
Q 2008	TRANSISTOR				UMD5N TR	G3070343		1-	A	B3
Q 2009	TRANSISTOR				UMD5N TR	G3070343		1-	A	C3
Q 2010	TRANSISTOR				UMD5N TR	G3070343		1-	A	B3
Q 2011	TRANSISTOR				UMD5N TR	G3070343		1-	A	C3
Q 2012	TRANSISTOR				UMD5N TR	G3070343		1-	A	B3
Q 2013	TRANSISTOR				UMD5N TR	G3070343		1-	A	B3
Q 2014	TRANSISTOR				UMD5N TR	G3070343		1-	A	B3
R 2001	CHIP RES.	100	1/16W	5%	RMC1/16 101JATP	J24185101		1-	A	B1
R 2002	CHIP RES.	100	1/16W	5%	RMC1/16 101JATP	J24185101		1-	A	B1
R 2003	CHIP RES.	100	1/16W	5%	RMC1/16 101JATP	J24185101		1-	A	C3
R 2004	CHIP RES.	100	1/16W	5%	RMC1/16 101JATP	J24185101		1-	A	C1
R 2005	CHIP RES.	100	1/16W	5%	RMC1/16 101JATP	J24185101		1-	A	A1
R 2006	CHIP RES.	100	1/16W	5%	RMC1/16 101JATP	J24185101		1-	A	B1
R 2007	CHIP RES.	1.5k	1/16W	5%	RMC1/16 152JATP	J24185152		1-	A	A2
R 2008	CHIP RES.	10	1/16W	5%	RMC1/16 100JATP	J24185100		1-	A	A2
R 2009	CHIP RES.	100	1/16W	5%	RMC1/16 101JATP	J24185101		1-	A	B1
R 2010	CHIP RES.	100	1/16W	5%	RMC1/16 101JATP	J24185101		1-	A	A2
R 2011	CHIP RES.	100	1/16W	5%	RMC1/16 101JATP	J24185101		1-	A	B1
R 2013	CHIP RES.	10	1/16W	5%	RMC1/16 100JATP	J24185100		1-	A	A1
R 2014	CHIP RES.	100	1/16W	5%	RMC1/16 101JATP	J24185101		1-	A	A2
R 2015	CHIP RES.	100	1/16W	5%	RMC1/16 101JATP	J24185101		1-	A	B3
R 2016	CHIP RES.	470	1/16W	5%	RMC1/16 471JATP	J24185471		1-	A	B3
R 2017	CHIP RES.	470	1/16W	5%	RMC1/16 471JATP	J24185471		1-	A	B3
R 2018	CHIP RES.	470	1/16W	5%	RMC1/16 471JATP	J24185471		1-	A	B3
R 2019	CHIP RES.	100	1/16W	5%	RMC1/16 101JATP	J24185101		1-	A	A2
R 2020	CHIP RES.	100	1/16W	5%	RMC1/16 101JATP	J24185101		1-	A	A3
R 2021	CHIP RES.	100	1/16W	5%	RMC1/16 101JATP	J24185101		1-	A	B3
R 2022	CHIP RES.	100	1/16W	5%	RMC1/16 101JATP	J24185101		1-	A	A3

VRF Unit

Parts List

REF	DESCRIPTION	VALUE	V/W	TOL.	MFR'S DESIG	VXSTD P/N	VERS.	LOT	SIDE	LAY ADR
R 2023	CHIP RES.	100	1/16W	5%	RMC1/16 101JATP	J24185101		1-	A	B3
R 2024	CHIP RES.	100	1/16W	5%	RMC1/16 101JATP	J24185101		1-	A	A3
RL2001	RELAY		DC12V		G6K-2F-Y-TR DC12V	M1190183		1-	A	C2
RL2002	RELAY		DC12V		G6K-2F-Y-TR DC12V	M1190183		1-	A	A2
RL2003	RELAY		DC12V		G6K-2F-Y-TR DC12V	M1190183		1-	A	A2
RL2004	RELAY		DC12V		G6K-2F-Y-TR DC12V	M1190183		1-	A	A1
RL2005	RELAY		DC12V		G6K-2F-Y-TR DC12V	M1190183		1-	A	B1
RL2006	RELAY		DC12V		G6K-2F-Y-TR DC12V	M1190183		1-	A	B1
RL2007	RELAY		DC12V		G6K-2F-Y-TR DC12V	M1190183		1-	A	B2
RL2008	RELAY		DC12V		G6K-2F-Y-TR DC12V	M1190183		1-	A	B1
RL2009	RELAY		DC12V		G6K-2F-Y-TR DC12V	M1190183		1-	A	A3
RL2010	RELAY		DC12V		G6K-2F-Y-TR DC12V	M1190183		1-	A	B3
RL2011	RELAY		DC12V		G6K-2F-Y-TR DC12V	M1190183		1-	A	A3
RL2012	RELAY		DC12V		G6K-2F-Y-TR DC12V	M1190183		1-	A	A3
RL2013	RELAY		DC12V		G6K-2F-Y-TR DC12V	M1190183		1-	A	B3
RL2014	RELAY		DC12V		G6K-2F-Y-TR DC12V	M1190183		1-	A	A3
RL2015	RELAY		DC12V		G6K-2F-Y-TR DC12V	M1190183		1-	A	B3
RL2016	RELAY		DC12V		G6K-2F-Y-TR DC12V	M1190183		1-	A	A3
	SHIELD CASE COVER				(74X92)	RA0830900		1		
	SHIELD CASE COVER				(74X92)	RA083090A		2-		

VRF Unit

Note:

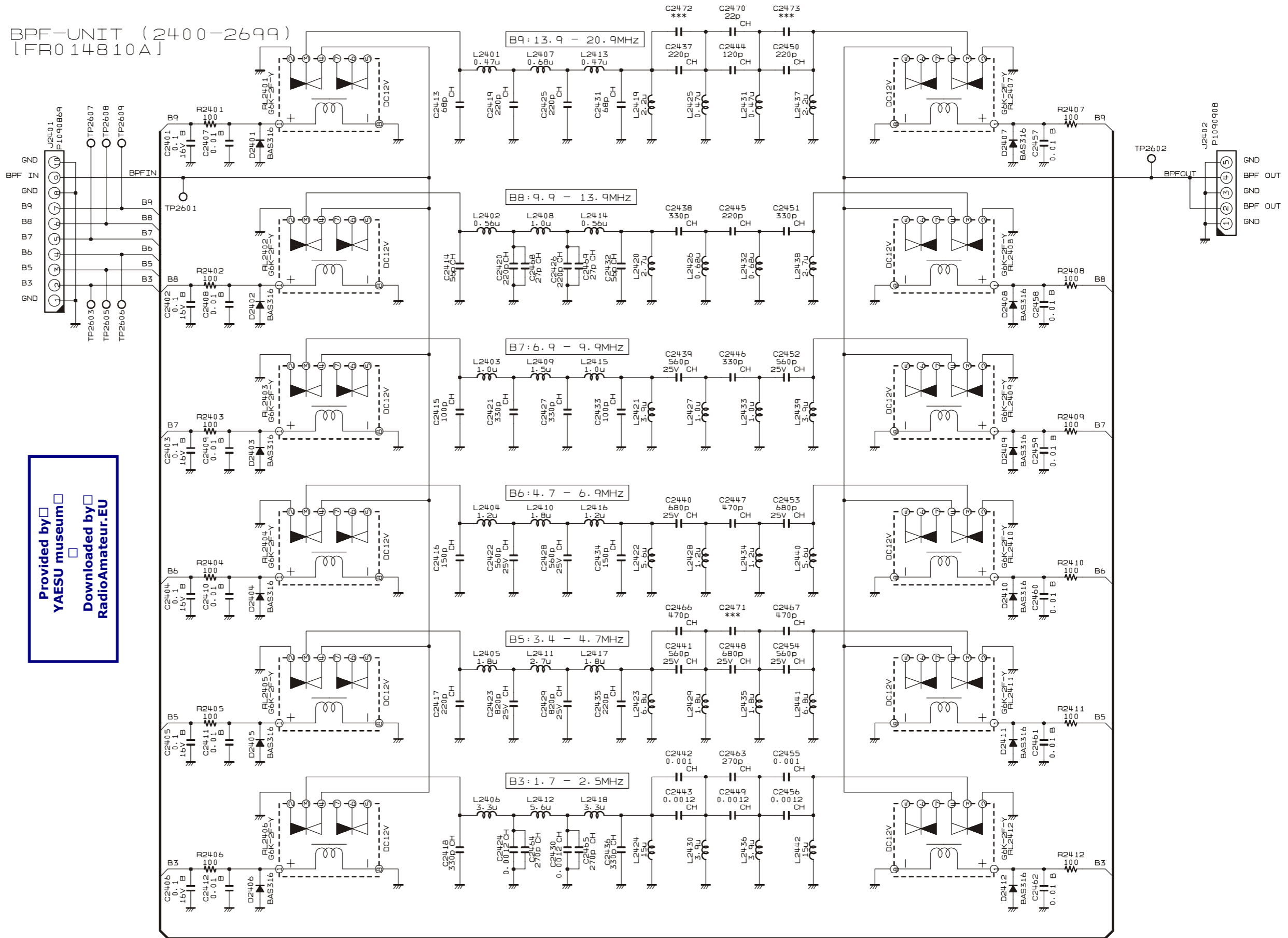

Provided by YAESU museum
Downloaded by RadioAmateur.EU

BPF Unit

Parts Layout

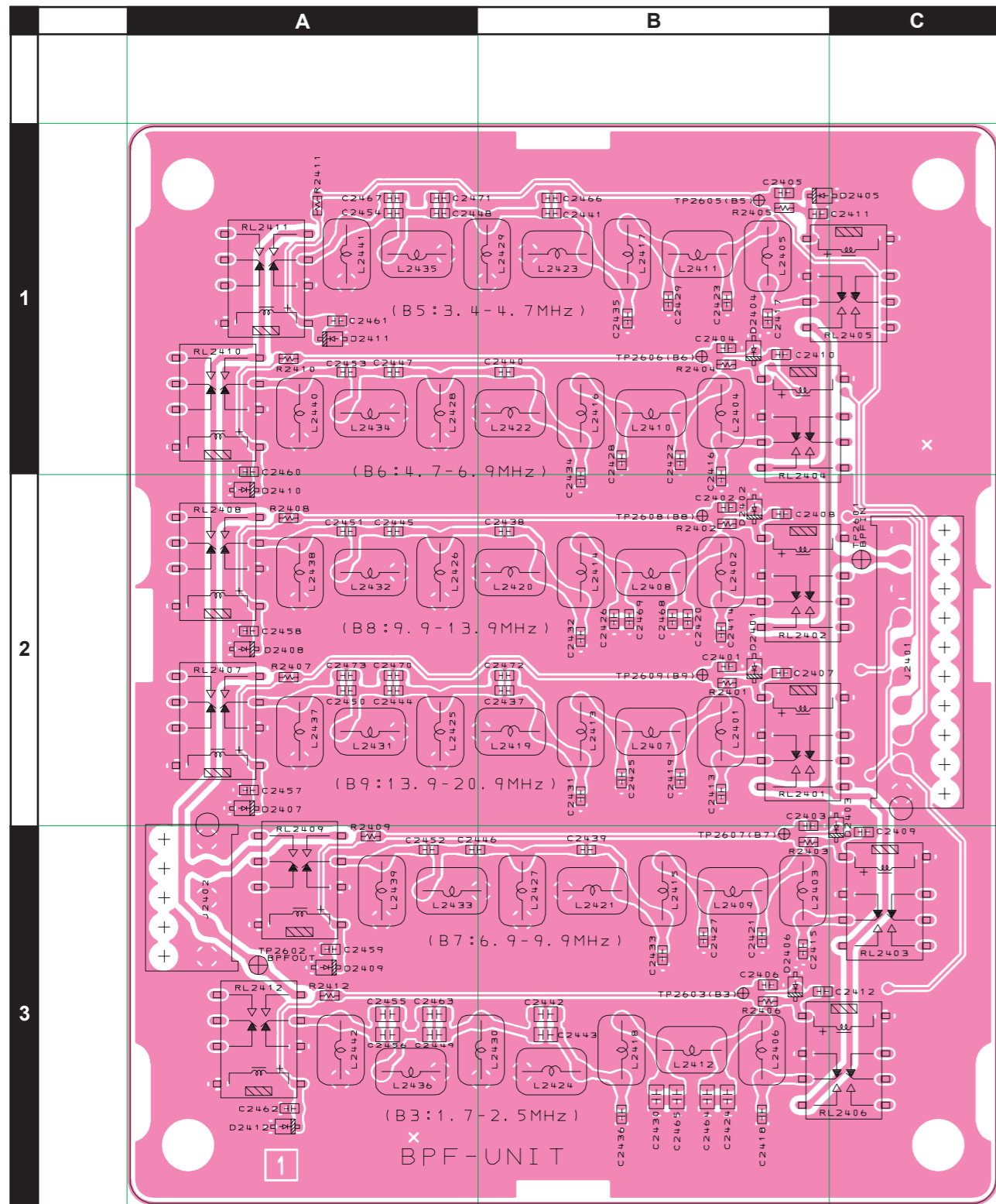

Side A

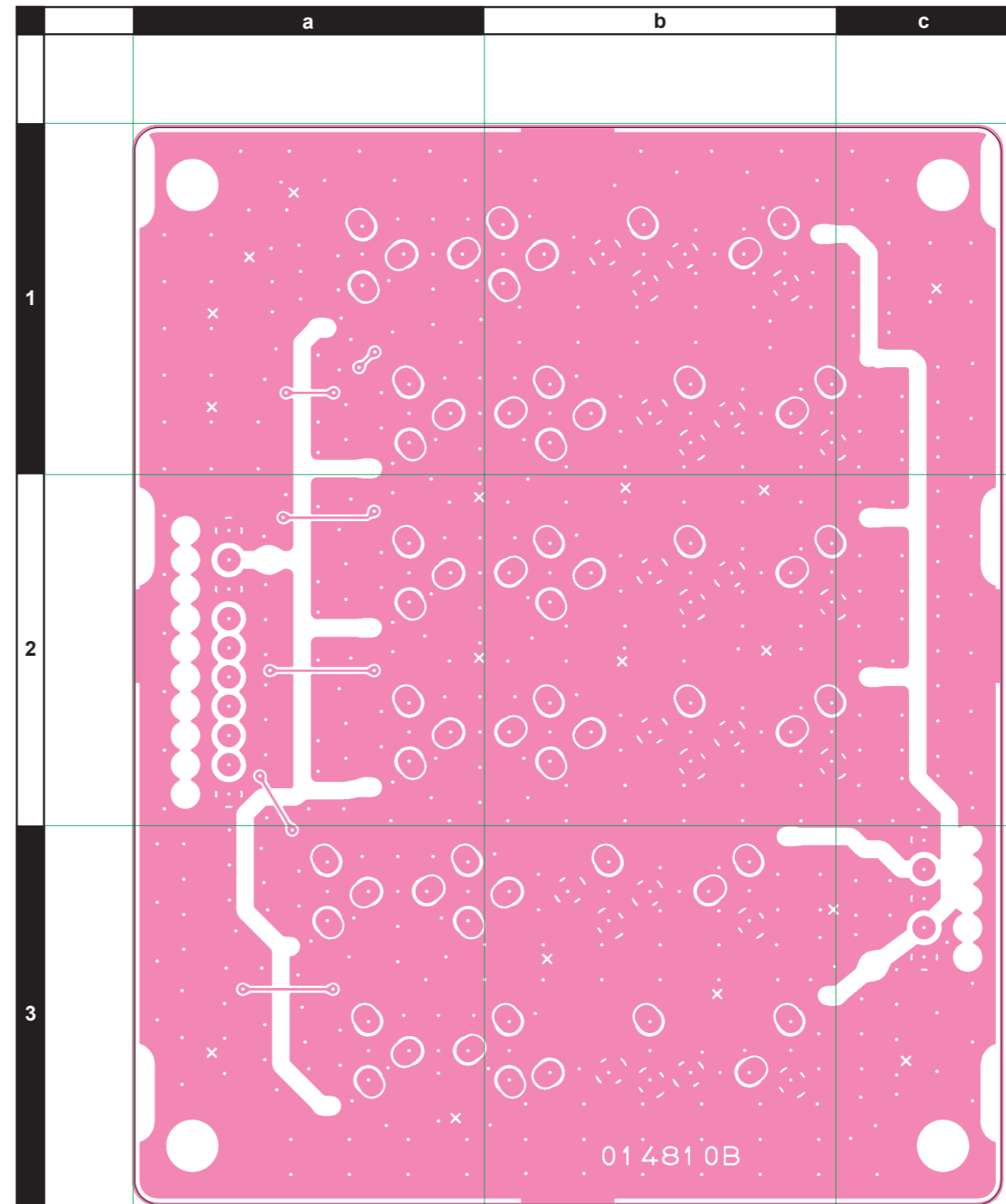

Side B

REF	DESCRIPTION	VALUE	V/W	TOL.	MFR'S DESIG	VXSTD P/N	VERS.	LOT	SIDE	LAY ADR
PCB with Components						CB3550001				
	Printed Circuit Board				AH025H000	FR0148100		1-	A	B2
C 2401	CHIP CAP.	0.1uF	16V	B	GRM188B11C104KA01D	K22124805		1-	A	B2
C 2402	CHIP CAP.	0.1uF	16V	B	GRM188B11C104KA01D	K22124805		1-	A	B2
C 2403	CHIP CAP.	0.1uF	16V	B	GRM188B11C104KA01D	K22124805		1-	A	B2
C 2404	CHIP CAP.	0.1uF	16V	B	GRM188B11C104KA01D	K22124805		1-	A	B1
C 2405	CHIP CAP.	0.1uF	16V	B	GRM188B11C104KA01D	K22124805		1-	A	B1
C 2406	CHIP CAP.	0.1uF	16V	B	GRM188B11C104KA01D	K22124805		1-	A	B3
C 2407	CHIP CAP.	0.01uF	50V	B	GRM188B11H103KA01D	K22174823		1-	A	B2
C 2408	CHIP CAP.	0.01uF	50V	B	GRM188B11H103KA01D	K22174823		1-	A	B2
C 2409	CHIP CAP.	0.01uF	50V	B	GRM188B11H103KA01D	K22174823		1-	A	C3
C 2410	CHIP CAP.	0.01uF	50V	B	GRM188B11H103KA01D	K22174823		1-	A	B1
C 2411	CHIP CAP.	0.01uF	50V	B	GRM188B11H103KA01D	K22174823		1-	A	B1
C 2412	CHIP CAP.	0.01uF	50V	B	GRM188B11H103KA01D	K22174823		1-	A	B3
C 2413	CHIP CAP.	68pF	50V	CH	GRM1882C1H680JA01D	K22174231		1-	A	B2
C 2414	CHIP CAP.	56pF	50V	CH	GRM1882C1H560JA01D	K22174229		1-	A	B2
C 2415	CHIP CAP.	100pF	50V	CH	GRM1882C1H101JA01D	K22174235		1-	A	B3
C 2416	CHIP CAP.	150pF	50V	CH	GRM1882C1H151JA01D	K22174239		1-	A	B1
C 2417	CHIP CAP.	220pF	50V	CH	GRM1882C1H221JA01D	K22174243		1-	A	B1
C 2418	CHIP CAP.	330pF	50V	CH	GRM1882C1H331JA01D	K22174253		1-	A	B3
C 2419	CHIP CAP.	220pF	50V	CH	GRM1882C1H221JA01D	K22174243		1-	A	B2
C 2420	CHIP CAP.	220pF	50V	CH	GRM1882C1H221JA01D	K22174243		1-	A	B2
C 2421	CHIP CAP.	330pF	50V	CH	GRM1882C1H331JA01D	K22174253		1-	A	B3
C 2422	CHIP CAP.	560pF	25V	CH	GRM39CH561J25PT	K22144201		1-	A	B1
C 2423	CHIP CAP.	820pF	25V	CH	GRM1882C1E821JA01D	K22144202		1-	A	B1
C 2424	CHIP CAP.	0.0012uF	50V	CH	GRM40CH122J50PT	K22170290		1-	A	B3
C 2425	CHIP CAP.	220pF	50V	CH	GRM1882C1H221JA01D	K22174243		1-	A	B2
C 2426	CHIP CAP.	220pF	50V	CH	GRM1882C1H221JA01D	K22174243		1-	A	B2
C 2427	CHIP CAP.	330pF	50V	CH	GRM1882C1H331JA01D	K22174253		1-	A	B3
C 2428	CHIP CAP.	560pF	25V	CH	GRM39CH561J25PT	K22144201		1-	A	B1
C 2429	CHIP CAP.	820pF	25V	CH	GRM1882C1E821JA01D	K22144202		1-	A	B1
C 2430	CHIP CAP.	0.0012uF	50V	CH	GRM40CH122J50PT	K22170290		1-	A	B3
C 2431	CHIP CAP.	68pF	50V	CH	GRM1882C1H680JA01D	K22174231		1-	A	B2
C 2432	CHIP CAP.	56pF	50V	CH	GRM1882C1H560JA01D	K22174229		1-	A	B2
C 2433	CHIP CAP.	100pF	50V	CH	GRM1882C1H101JA01D	K22174235		1-	A	B3
C 2434	CHIP CAP.	150pF	50V	CH	GRM1882C1H151JA01D	K22174239		1-	A	B2
C 2435	CHIP CAP.	220pF	50V	CH	GRM1882C1H221JA01D	K22174243		1-	A	B1
C 2436	CHIP CAP.	330pF	50V	CH	GRM1882C1H331JA01D	K22174253		1-	A	B3
C 2437	CHIP CAP.	220pF	50V	CH	GRM1882C1H221JA01D	K22174243		1-	A	B2
C 2438	CHIP CAP.	330pF	50V	CH	GRM1882C1H331JA01D	K22174253		1-	A	B2
C 2439	CHIP CAP.	560pF	25V	CH	GRM39CH561J25PT	K22144201		1-	A	B3
C 2440	CHIP CAP.	680pF	25V	CH	GRM39CH681J25PT	K22144203		1-	A	B1
C 2441	CHIP CAP.	560pF	25V	CH	GRM39CH561J25PT	K22144201		1-	A	B1
C 2442	CHIP CAP.	0.001uF	50V	CH	GRM40CH102J50PT	K22170288		1-	A	B3
C 2443	CHIP CAP.	0.0012uF	50V	CH	GRM40CH122J50PT	K22170290		1-	A	B3
C 2444	CHIP CAP.	120pF	50V	CH	GRM1882C1H121JA01D	K22174237		1-	A	A2
C 2445	CHIP CAP.	220pF	50V	CH	GRM1882C1H221JA01D	K22174243		1-	A	A2
C 2446	CHIP CAP.	330pF	50V	CH	GRM1882C1H331JA01D	K22174253		1-	A	A3
C 2447	CHIP CAP.	470pF	50V	CH	GRM1882C1H471JA01D	K22174249		1-	A	A1
C 2448	CHIP CAP.	680pF	25V	CH	GRM39CH681J25PT	K22144203		1-	A	A1
C 2449	CHIP CAP.	0.0012uF	50V	CH	GRM40CH122J50PT	K22170290		1-	A	A3
C 2450	CHIP CAP.	220pF	50V	CH	GRM1882C1H221JA01D	K22174243		1-	A	A2
C 2451	CHIP CAP.	330pF	50V	CH	GRM1882C1H331JA01D	K22174253		1-	A	A2
C 2452	CHIP CAP.	560pF	25V	CH	GRM39CH561J25PT	K22144201		1-	A	A3
C 2453	CHIP CAP.	680pF	25V	CH	GRM39CH681J25PT	K22144203		1-	A	A1
C 2454	CHIP CAP.	560pF	25V	CH	GRM39CH561J25PT	K22144201		1-	A	A1
C 2455	CHIP CAP.	0.001uF	50V	CH	GRM40CH102J50PT	K22170288		1-	A	A3
C 2456	CHIP CAP.	0.0012uF	50V	CH	GRM40CH122J50PT	K22170290		1-	A	A3
C 2457	CHIP CAP.	0.01uF	50V	B	GRM188B11H103KA01D	K22174823		1-	A	A2
C 2458	CHIP CAP.	0.01uF	50V	B	GRM188B11H103KA01D	K22174823		1-	A	A2
C 2459	CHIP CAP.	0.01uF	50V	B	GRM188B11H103KA01D	K22174823		1-	A	A3
C 2460	CHIP CAP.	0.01uF	50V	B	GRM188B11H103KA01D	K22174823		1-	A	A1
C 2461	CHIP CAP.	0.01uF	50V	B	GRM188B11H103KA01D	K22174823		1-	A	A1
C 2462	CHIP CAP.	0.01uF	50V	B	GRM188B11H103KA01D	K22174823		1-	A	A3
C 2463	CHIP CAP.	270pF	50V	CH	GRM2162C1H271JA01D	K22170245		1-	A	A3
C 2464	CHIP CAP.	270pF	50V	CH	GRM2162C1H271JA01D	K22170245		1-	A	B3
C 2465	CHIP CAP.	270pF	50V	CH	GRM2162C1H271JA01D	K22170245		1-	A	B3
C 2466	CHIP CAP.	470pF	50V	CH	GRM1882C1H471JA01D	K22174249		1-	A	B1
C 2467	CHIP CAP.	470pF	50V	CH	GRM1882C1H471JA01D	K22174249		1-	A	A1
C 2468	CHIP CAP.	27pF	50V	CH	GRM1882C1H270JA01D	K22174221		1-	A	B2
C 2469	CHIP CAP.	27pF	50V	CH	GRM1882C1H270JA01D	K22174221		1-	A	B2
C 2470	CHIP CAP.	22pF	50V	CH	GRM1882C1H220JA01D	K22174219		1-	A	A2
D 2401	DIODE				BAS316	G2070716		1-	A	B2

BPF Unit

Parts List

REF	DESCRIPTION	VALUE	V/W	TOL.	MFR'S DESIG	VXSTD P/N	VERS.	LOT	SIDE	LAY ADR
D 2402	DIODE				BAS316	G2070716		1-	A	B2
D 2403	DIODE				BAS316	G2070716		1-	A	C2
D 2404	DIODE				BAS316	G2070716		1-	A	B1
D 2405	DIODE				BAS316	G2070716		1-	A	B1
D 2406	DIODE				BAS316	G2070716		1-	A	B3
D 2407	DIODE				BAS316	G2070716		1-	A	A2
D 2408	DIODE				BAS316	G2070716		1-	A	A2
D 2409	DIODE				BAS316	G2070716		1-	A	A3
D 2410	DIODE				BAS316	G2070716		1-	A	A2
D 2411	DIODE				BAS316	G2070716		1-	A	A1
D 2412	DIODE				BAS316	G2070716		1-	A	A3
J 2401	CONNECTOR				IMSA-9133S-10D	P1090869		1-	A	C2
J 2402	CONNECTOR				IMSA-9133S-05D	P1090908		1-	A	A3
L 2401	M.RFC	0.47uH			LAV35VBR47M	L1790215		1-	A	B2
L 2402	M.RFC	0.56uH			LAV35VBR56M	L1790216		1-	A	B2
L 2403	M.RFC	1uH			LAV35VB1R0K	L1790219		1-	A	B3
L 2404	M.RFC	1.2uH			LAV35VB1R2K	L1790220		1-	A	B1
L 2405	M.RFC	1.8uH			LAV35VB1R8K	L1790222		1-	A	B1
L 2406	M.RFC	3.3uH			LAV35VB3R3K	L1790225		1-	A	B3
L 2407	M.RFC	0.68uH			LAV35VBR68M	L1790217		1-	A	B2
L 2408	M.RFC	1uH			LAV35VB1R0K	L1790219		1-	A	B2
L 2409	M.RFC	1.5uH			LAV35VB1R5K	L1790221		1-	A	B3
L 2410	M.RFC	1.8uH			LAV35VB1R8K	L1790222		1-	A	B1
L 2411	M.RFC	2.7uH			LAV35VB2R7K	L1790224		1-	A	B1
L 2412	M.RFC	5.6uH			LAV35VB5R6K	L1790228		1-	A	B3
L 2413	M.RFC	0.47uH			LAV35VBR47M	L1790215		1-	A	B2
L 2414	M.RFC	0.56uH			LAV35VBR56M	L1790216		1-	A	B2
L 2415	M.RFC	1uH			LAV35VB1R0K	L1790219		1-	A	B3
L 2416	M.RFC	1.2uH			LAV35VB1R2K	L1790220		1-	A	B1
L 2417	M.RFC	1.8uH			LAV35VB1R8K	L1790222		1-	A	B1
L 2418	M.RFC	3.3uH			LAV35VB3R3K	L1790225		1-	A	B3
L 2419	M.RFC	2.2uH			LAV35VB2R2K	L1790223		1-	A	B2
L 2420	M.RFC	2.7uH			LAV35VB2R7K	L1790224		1-	A	B2
L 2421	M.RFC	3.9uH			LAV35VB3R9K	L1790226		1-	A	B3
L 2422	M.RFC	5.6uH			LAV35VB5R6K	L1790228		1-	A	B1
L 2423	M.RFC	6.8uH			LAV35VB6R8K	L1790229		1-	A	B1
L 2424	M.RFC	15uH			LAV35VB150K	L1790233		1-	A	B3
L 2425	M.RFC	0.47uH			LAV35VBR47M	L1790215		1-	A	A2
L 2426	M.RFC	0.68uH			LAV35VBR68M	L1790217		1-	A	A2
L 2427	M.RFC	1uH			LAV35VB1R0K	L1790219		1-	A	B3
L 2428	M.RFC	1.2uH			LAV35VB1R2K	L1790220		1-	A	A1
L 2429	M.RFC	1.8uH			LAV35VB1R8K	L1790222		1-	A	B1
L 2430	M.RFC	3.9uH			LAV35VB3R9K	L1790226		1-	A	B3
L 2431	M.RFC	0.47uH			LAV35VBR47M	L1790215		1-	A	A2
L 2432	M.RFC	0.68uH			LAV35VBR68M	L1790217		1-	A	A2
L 2433	M.RFC	1uH			LAV35VB1R0K	L1790219		1-	A	B3
L 2434	M.RFC	1.2uH			LAV35VB1R2K	L1790220		1-	A	A1
L 2435	M.RFC	1.8uH			LAV35VB1R8K	L1790222		1-	A	A1
L 2436	M.RFC	3.9uH			LAV35VB3R9K	L1790226		1-	A	A3
L 2437	M.RFC	2.2uH			LAV35VB2R2K	L1790223		1-	A	A2
L 2438	M.RFC	2.7uH			LAV35VB2R7K	L1790224		1-	A	A2
L 2439	M.RFC	3.9uH			LAV35VB3R9K	L1790226		1-	A	A3
L 2440	M.RFC	5.6uH			LAV35VB5R6K	L1790228		1-	A	A1
L 2441	M.RFC	6.8uH			LAV35VB6R8K	L1790229		1-	A	A1
L 2442	M.RFC	15uH			LAV35VB150K	L1790233		1-	A	A3
R 2401	CHIP RES.	100	1/16W	5%	RMC1/16 101JATP	J24185101		1-	A	B2
R 2402	CHIP RES.	100	1/16W	5%	RMC1/16 101JATP	J24185101		1-	A	B2
R 2403	CHIP RES.	100	1/16W	5%	RMC1/16 101JATP	J24185101		1-	A	B3
R 2404	CHIP RES.	100	1/16W	5%	RMC1/16 101JATP	J24185101		1-	A	B1
R 2405	CHIP RES.	100	1/16W	5%	RMC1/16 101JATP	J24185101		1-	A	B1
R 2406	CHIP RES.	100	1/16W	5%	RMC1/16 101JATP	J24185101		1-	A	B3
R 2407	CHIP RES.	100	1/16W	5%	RMC1/16 101JATP	J24185101		1-	A	A2
R 2408	CHIP RES.	100	1/16W	5%	RMC1/16 101JATP	J24185101		1-	A	A2
R 2409	CHIP RES.	100	1/16W	5%	RMC1/16 101JATP	J24185101		1-	A	A3
R 2410	CHIP RES.	100	1/16W	5%	RMC1/16 101JATP	J24185101		1-	A	A1
R 2411	CHIP RES.	100	1/16W	5%	RMC1/16 101JATP	J24185101		1-	A	A1
R 2412	CHIP RES.	100	1/16W	5%	RMC1/16 101JATP	J24185101		1-	A	A3
RL2401	RELAY		DC12V		G6K-2F-Y-TR DC12V	M1190183		1-	A	B2
RL2402	RELAY		DC12V		G6K-2F-Y-TR DC12V	M1190183		1-	A	B2
RL2403	RELAY		DC12V		G6K-2F-Y-TR DC12V	M1190183		1-	A	C3
RL2404	RELAY		DC12V		G6K-2F-Y-TR DC12V	M1190183		1-	A	B1
RL2405	RELAY		DC12V		G6K-2F-Y-TR DC12V	M1190183		1-	A	C1
RL2406	RELAY		DC12V		G6K-2F-Y-TR DC12V	M1190183		1-	A	C3

BPF Unit

Parts List

REF	DESCRIPTION	VALUE	V/W	TOL.	MFR'S DESIG	VXSTD P/N	VERS.	LOT	SIDE	LAY ADR
RL2407	RELAY		DC12V		G6K-2F-Y-TR DC12V	M1190183		1-	A	A2
RL2408	RELAY		DC12V		G6K-2F-Y-TR DC12V	M1190183		1-	A	A2
RL2409	RELAY		DC12V		G6K-2F-Y-TR DC12V	M1190183		1-	A	A3
RL2410	RELAY		DC12V		G6K-2F-Y-TR DC12V	M1190183		1-	A	A1
RL2411	RELAY		DC12V		G6K-2F-Y-TR DC12V	M1190183		1-	A	A1
RL2412	RELAY		DC12V		G6K-2F-Y-TR DC12V	M1190183		1-	A	A3
Z 2401	SHIELD CASE COVER SHIELD CASE COVER				(74X92) (74X92)	RA0830900 RA083090A		1 2-		

BPF Unit

Note:

Provided by
YAESU museum
Downloaded by
RadioAmateur.EU

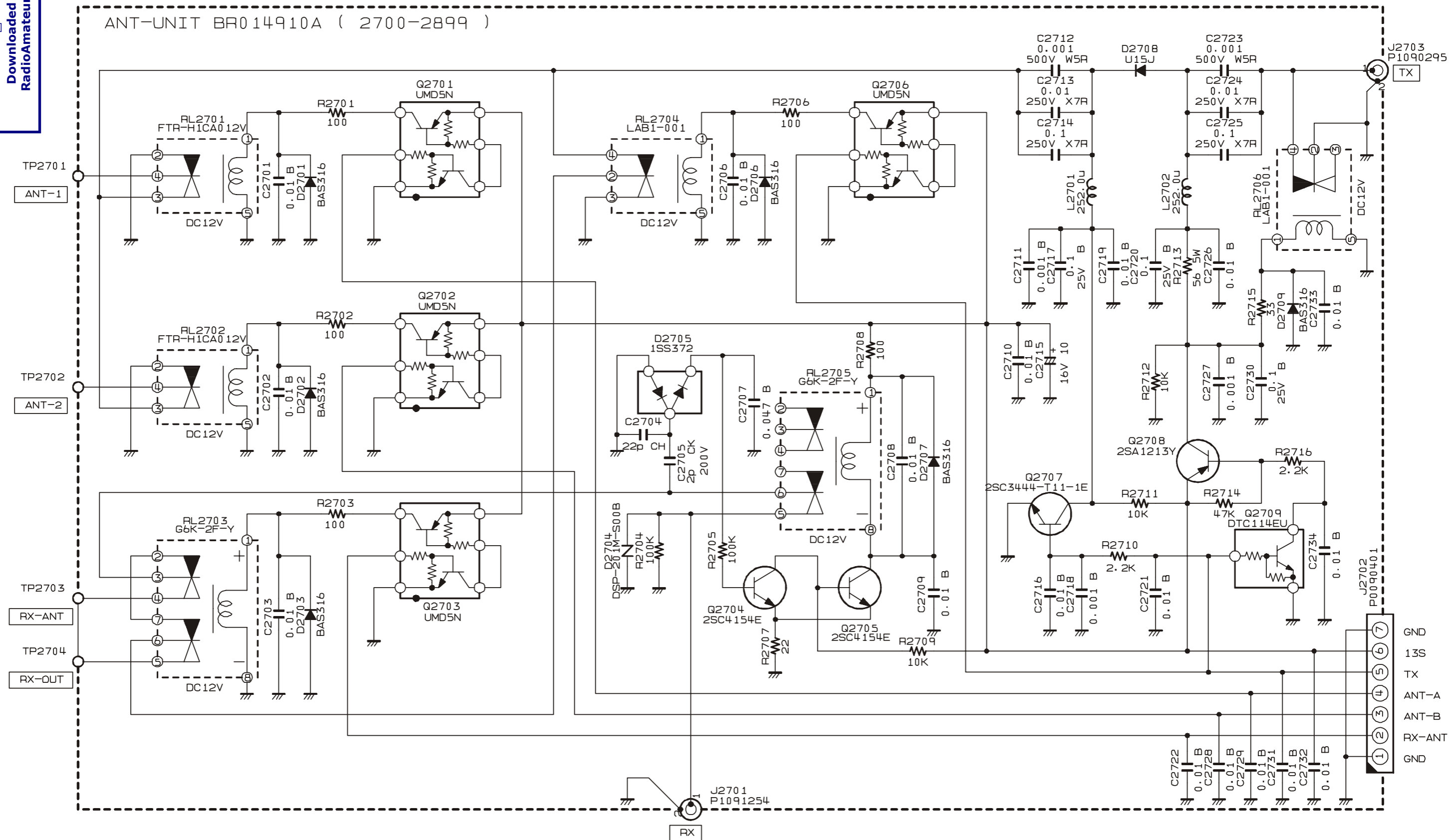

ANT Unit

Note

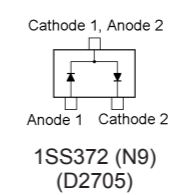
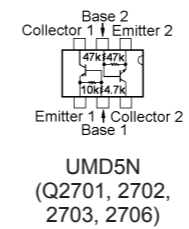
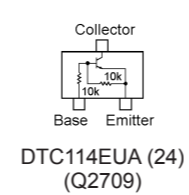
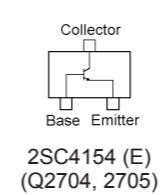
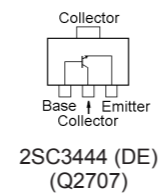
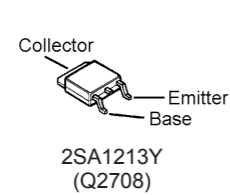
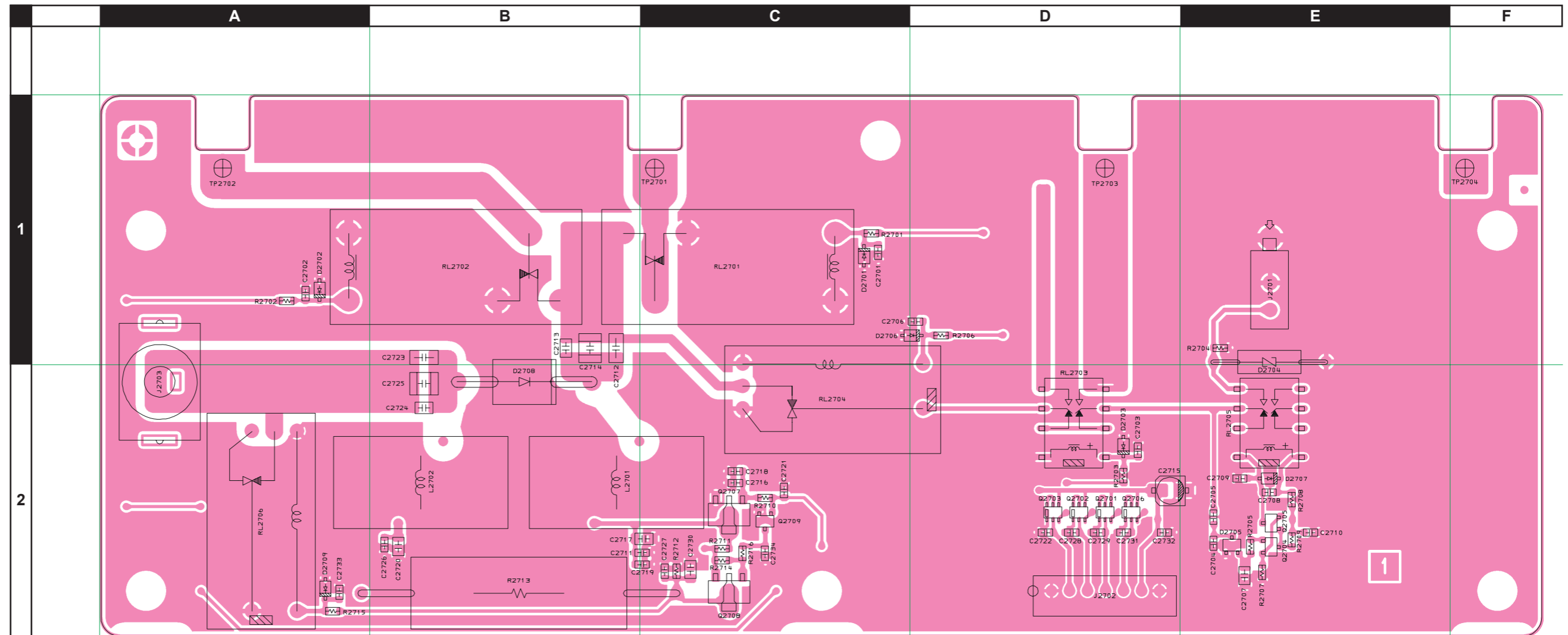

ANT Unit

Parts Layout (Side B)

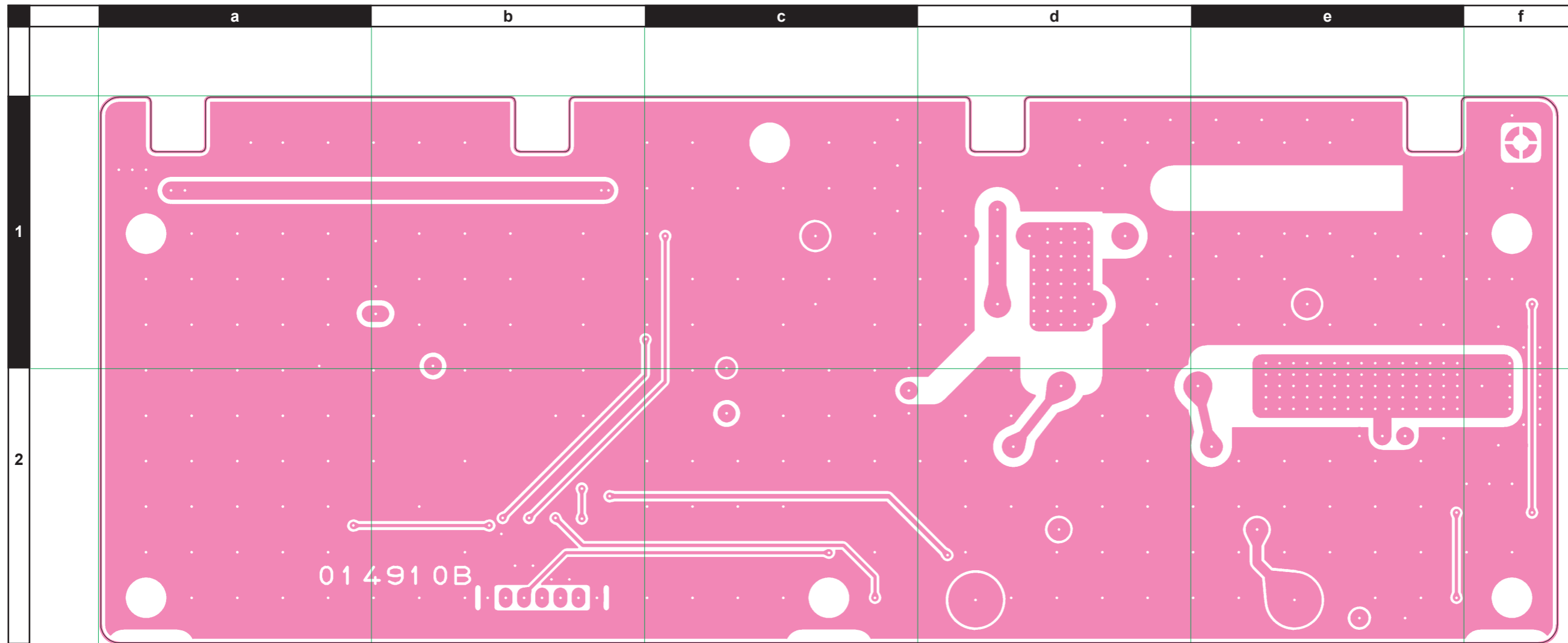

REF	DESCRIPTION	VALUE	V/W	TOL.	MFR'S DESIG	VXSTD P/N	VERS.	LOT	SIDE	LAY ADR	
PCB with Components						CB3569001					
Printed Circuit Board						AH025H000	FR014910B		1-		
C 2702	CHIP CAP.	0.01uF	50V	B	GRM188B11H103KA01D	K22174823		1-	A	A1	
C 2703	CHIP CAP.	0.01uF	50V	B	GRM188B11H103KA01D	K22174823		1-	A	D2	
C 2704	CHIP CAP.	22pF	50V	CH	GRM1882C1H220JA01D	K22174219		1-	A	E2	
C 2705	CHIP CAP.	2pF	200V	CK	GRM1884C2D2R0CV01D	K22234204		1-	A	E2	
C 2706	CHIP CAP.	0.01uF	50V	B	GRM188B11H103KA01D	K22174823		1-	A	D1	
C 2707	CHIP CAP.	0.047uF	50V	B	GRM40B473M50PT	K22170823		1-	A	E2	
C 2708	CHIP CAP.	0.01uF	50V	B	GRM188B11H103KA01D	K22174823		1-	A	E2	
C 2709	CHIP CAP.	0.01uF	50V	B	GRM188B11H103KA01D	K22174823		1-	A	E2	
C 2710	CHIP CAP.	0.01uF	50V	B	GRM188B11H103KA01D	K22174823		1-	A	E2	
C 2711	CHIP CAP.	0.001uF	50V	B	GRM188B11H102KA01D	K22174821		1-	A	C2	
C 2712	CHIP CAP.	0.001uF	500V	W5R	CF316W5R102K500AT	K22271802		1-	A	B1	
C 2713	CHIP CAP.	0.01uF	250V	X7R	GRM21BR72E103KW03L	K22240801		1-	A	B1	
C 2714	CHIP CAP.	0.1uF	250V	X7R	GRM32DR72E104KW01L	K22245801		1-	A	B1	
C 2715	AL.ELECTRO.CAP.	10uF	16V		RV2-16V100MB55U-R	K48120014		1-	A	D2	
C 2716	CHIP CAP.	0.01uF	50V	B	GRM188B11H103KA01D	K22174823		1-	A	C2	
C 2717	CHIP CAP.	0.1uF	25V	B	GRM40B104M25PT	K22140811		1-	A	C2	
C 2718	CHIP CAP.	0.001uF	50V	B	GRM188B11H102KA01D	K22174821		1-	A	C2	
C 2719	CHIP CAP.	0.01uF	50V	B	GRM188B11H103KA01D	K22174823		1-	A	C2	
C 2720	CHIP CAP.	0.1uF	25V	B	GRM40B104M25PT	K22140811		1-	A	B2	
C 2721	CHIP CAP.	0.01uF	50V	B	GRM188B11H103KA01D	K22174823		1-	A	C2	
C 2722	CHIP CAP.	0.01uF	50V	B	GRM188B11H103KA01D	K22174823		1-	A	D2	
C 2723	CHIP CAP.	0.001uF	500V	W5R	CF316W5R102K500AT	K22271802		1-	A	B1	
C 2724	CHIP CAP.	0.01uF	250V	X7R	GRM21BR72E103KW03L	K22240801		1-	A	B2	
C 2725	CHIP CAP.	0.1uF	250V	X7R	GRM32DR72E104KW01L	K22245801		1-	A	B2	
C 2726	CHIP CAP.	0.01uF	50V	B	GRM188B11H103KA01D	K22174823		1-	A	B2	
C 2727	CHIP CAP.	0.001uF	50V	B	GRM188B11H102KA01D	K22174821		1-	A	C2	
C 2728	CHIP CAP.	0.01uF	50V	B	GRM188B11H103KA01D	K22174823		1-	A	D2	
C 2729	CHIP CAP.	0.01uF	50V	B	GRM188B11H103KA01D	K22174823		1-	A	D2	
C 2730	CHIP CAP.	0.1uF	25V	B	GRM40B104M25PT	K22140811		1-	A	C2	
C 2731	CHIP CAP.	0.01uF	50V	B	GRM188B11H103KA01D	K22174823		1-	A	D2	
C 2732	CHIP CAP.	0.01uF	50V	B	GRM188B11H103KA01D	K22174823		1-	A	D2	
C 2733	CHIP CAP.	0.01uF	50V	B	GRM188B11H103KA01D	K22174823		1-	A	A2	
C 2734	CHIP CAP.	0.01uF	50V	B	GRM188B11H103KA01D	K22174823		1-	A	C2	
D 2701	DIODE				BAS316	G2070716		1-	A	C1	
D 2702	DIODE				BAS316	G2070716		1-	A	A1	
D 2703	DIODE				BAS316	G2070716		1-	A	D2	
D 2704	SURGE ABSORBER				DSP201M-S00B	Q9000375		1-	A	E1	
D 2705	DIODE				1SS372(TE85R.F)	G2070632		1-	A	E2	
D 2706	DIODE				BAS316	G2070716		1-	A	D1	
D 2707	DIODE				BAS316	G2070716		1-	A	E2	
D 2708	DIODE				U15J	G2090572		1-	A	B2	
D 2709	DIODE				BAS316	G2070716		1-	A	A2	
J 2701	CONNECTOR				TMP-S01X-C1	P1091254		1-	A	E1	
J 2702	CONNECTOR				B7B-PH-K-S	P0090401		1-	A	D2	
J 2703	CONNECTOR				S-Q3063#01	P1090295		1-	A	A2	
L 2701	TOROIDAL COIL	252uH			252.0U D12A TR16	L0022881A		1-	A	B2	
L 2702	TOROIDAL COIL	252uH			252.0U D12A TR16	L0022881A		1-	A	B2	
Q 2701	TRANSISTOR				UMD5N TR	G3070343		1-	A	D2	
Q 2702	TRANSISTOR				UMD5N TR	G3070343		1-	A	D2	
Q 2703	TRANSISTOR				UMD5N TR	G3070343		1-	A	D2	
Q 2704	TRANSISTOR				2SC4154-T11-1E	G3341548E		1-	A	E2	
Q 2705	TRANSISTOR				2SC4154-T11-1E	G3341548E		1-	A	E2	
Q 2706	TRANSISTOR				UMD5N TR	G3070343		1-	A	D2	
Q 2707	TRANSISTOR				2SC3444-T11-1E	G3334448E		1-	A	C2	
Q 2708	TRANSISTOR				2SA1213Y(TE12R.CF)	G3112137Y		1-	A	C2	
Q 2709	TRANSISTOR				DTC114EUA T106	G3070084		1-	A	C2	
R 2701	CHIP RES.	100	1/16W	5%	RMC1/16 101JATP	J24185101		1-	A	C1	
R 2702	CHIP RES.	100	1/16W	5%	RMC1/16 101JATP	J24185101		1-	A	A1	
R 2703	CHIP RES.	100	1/16W	5%	RMC1/16 101JATP	J24185101		1-	A	D2	
R 2704	CHIP RES.	100k	1/16W	5%	RMC1/16 104JATP	J24185104		1-	A	E1	
R 2705	CHIP RES.	100k	1/16W	5%	RMC1/16 104JATP	J24185104		1-	A	E2	
R 2706	CHIP RES.	100	1/16W	5%	RMC1/16 101JATP	J24185101		1-	A	D1	
R 2707	CHIP RES.	22	1/16W	5%	RMC1/16 220JATP	J24185220		1-	A	E2	
R 2708	CHIP RES.	100	1/16W	5%	RMC1/16 101JATP	J24185101		1-	A	E2	
R 2709	CHIP RES.	10k	1/16W	5%	RMC1/16 103JATP	J24185103		1-	A	E2	
R 2710	CHIP RES.	2.2k	1/16W	5%	RMC1/16 222JATP	J24185222		1-	A	C2	
R 2711	CHIP RES.	10k	1/16W	5%	RMC1/16 103JATP	J24185103		1-	A	C2	
R 2712	CHIP RES.	10k	1/16W	5%	RMC1/16 103JATP	J24185103		1-	A	C2	
R 2713	METAL FILM RES.	56	5W	5%	ERG-5SJ560	J22379015		1-	A	C2	
R 2714	CHIP RES.	47k	1/16W	5%	RMC1/16 473JATP	J24185473		1-	A	C2	
R 2715	CHIP RES.	33	1/16W	5%	RMC1/16 330JATP	J24185330		1-	A	A2	

ANT Unit

Parts List

REF	DESCRIPTION	VALUE	V/W	TOL.	MFR'S DESIG	VXSTD P/N	VERS.	LOT	SIDE	LAY ADR
R 2716	CHIP RES.	2.2k	1/16W	5%	RMC1/16 222JATP	J24185222		1-	A	C2
RL2701	RELAY		DC12V		FTR-H1CA012V DC12V	M1190148		1-	A	C1
RL2702	RELAY		DC12V		FTR-H1CA012V DC12V	M1190148		1-	A	B1
RL2703	RELAY		DC12V		G6K-2F-Y-TR DC12V	M1190183		1-	A	D2
RL2704	RELAY		DC12V		LAB1-001 DC12V	M1190194		1-	A	D1
RL2705	RELAY		DC12V		G6K-2F-Y-TR DC12V	M1190183		1-	A	E2
RL2706	RELAY		DC12V		LAB1-001 DC12V	M1190194		1-7	A	A2

DVS Unit

Circuit Diagram

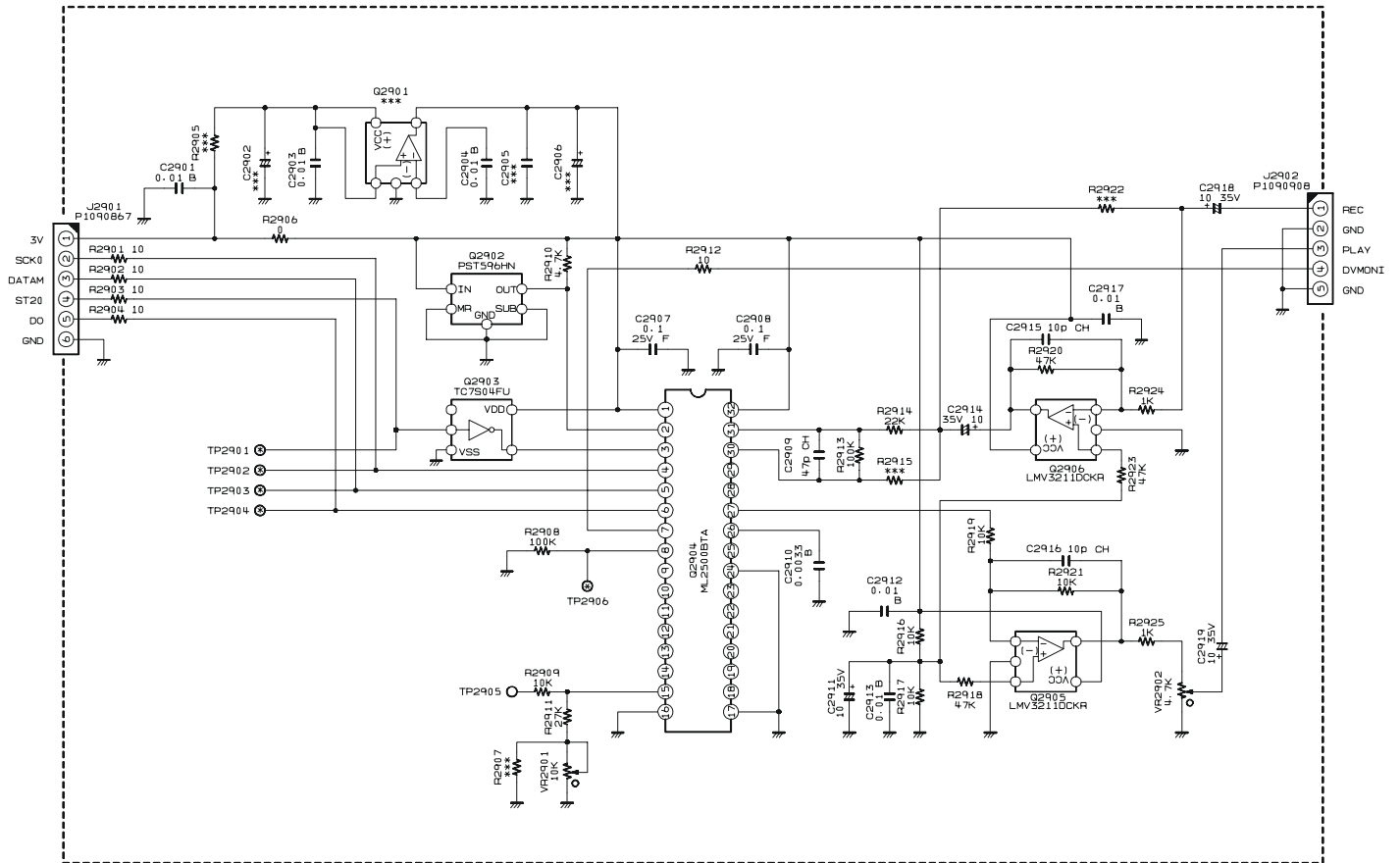

Parts Layout

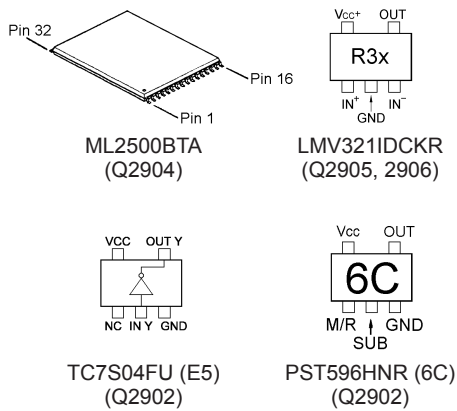

Side A

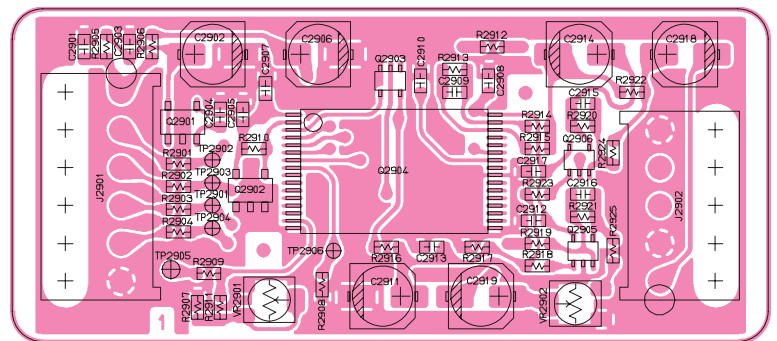

Side B

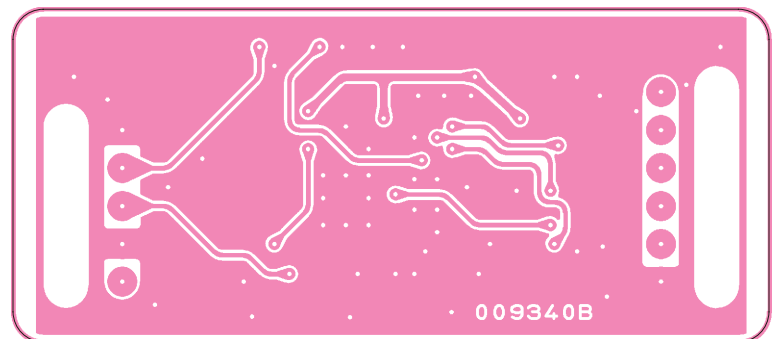

DVS Unit

Parts List

REF	DESCRIPTION	VALUE	V/W	TOL.	MFR'S DESIG	VXSTD P/N	VERS.	LOT	SIDE	LAY ADR
PCB with Components						CB3551001				
	Printed Circuit Board				AH010H000	FR0093400		1-	A	
C 2901	CHIP CAP.	0.01uF	50V	B	GRM188B11H103KA01D	K22174823		1-	A	
C 2903	CHIP CAP.	0.01uF	50V	B	GRM188B11H103KA01D	K22174823		1-	A	
C 2904	CHIP CAP.	0.01uF	50V	B	GRM188B11H103KA01D	K22174823		1-	A	
C 2907	CHIP CAP.	0.1uF	25V	F	GRM39F104Z25PT	K22145001		1-	A	
C 2908	CHIP CAP.	0.1uF	25V	F	GRM39F104Z25PT	K22145001		1-	A	
C 2909	CHIP CAP.	47pF	50V	CH	GRM1882C1H470JA01D	K22174227		1-	A	
C 2910	CHIP CAP.	0.0033uF	50V	B	GRM188B11H332KA01D	K22174831		1-	A	
C 2911	AL.ELECTRO.CAP.	10uF	35V		EEE1VA100WR	K48160006		1-	A	
C 2912	CHIP CAP.	0.01uF	50V	B	GRM188B11H103KA01D	K22174823		1-	A	
C 2913	CHIP CAP.	0.01uF	50V	B	GRM188B11H103KA01D	K22174823		1-	A	
C 2914	AL.ELECTRO.CAP.	10uF	35V		EEE1VA100WR	K48160006		1-	A	
C 2915	CHIP CAP.	10pF	50V	CH	GRM1882C1H100JA01D	K22174211		1-	A	
C 2916	CHIP CAP.	10pF	50V	CH	GRM1882C1H100JA01D	K22174211		1-	A	
C 2917	CHIP CAP.	0.01uF	50V	B	GRM188B11H103KA01D	K22174823		1-	A	
C 2918	AL.ELECTRO.CAP.	10uF	35V		EEE1VA100WR	K48160006		1-	A	
C 2919	AL.ELECTRO.CAP.	10uF	35V		EEE1VA100WR	K48160006		1-	A	
J 2901	CONNECTOR				IMSA-9133S-06D	P1090867		1-	A	
J 2902	CONNECTOR				IMSA-9133S-05D	P1090908		1-	A	
Q 2902	IC				PST596HNR	G1092574		1-	A	
Q 2903	IC				TC7S04FU(TE85R.F)	G1091530		1-	A	
Q 2904	IC				ML2500BTA	G1093715		1-	A	
Q 2905	IC				LMV321DCKR	G1093969		1-	A	
Q 2906	IC				LMV321DCKR	G1093969		1-	A	
R 2901	CHIP RES.	10	1/16W	5%	RMC1/16 100JATP	J24185100		1-	A	
R 2902	CHIP RES.	10	1/16W	5%	RMC1/16 100JATP	J24185100		1-	A	
R 2903	CHIP RES.	10	1/16W	5%	RMC1/16 100JATP	J24185100		1-	A	
R 2904	CHIP RES.	10	1/16W	5%	RMC1/16 100JATP	J24185100		1-	A	
R 2906	CHIP RES.	0	1/16W	5%	RMC1/16 000JATP	J24185000		1-	A	
R 2908	CHIP RES.	100k	1/16W	5%	RMC1/16 104JATP	J24185104		1-	A	
R 2909	CHIP RES.	10k	1/16W	5%	RMC1/16 103JATP	J24185103		1-	A	
R 2910	CHIP RES.	4.7k	1/16W	5%	RMC1/16 472JATP	J24185472		1-	A	
R 2911	CHIP RES.	27k	1/16W	5%	RMC1/16 273JATP	J24185273		1-	A	
R 2912	CHIP RES.	10	1/16W	5%	RMC1/16 100JATP	J24185100		1-	A	
R 2913	CHIP RES.	22k	1/16W	5%	RMC1/16 223JATP	J24185223		1-	A	
R 2914	CHIP RES.	22k	1/16W	5%	RMC1/16 223JATP	J24185223		1-	A	
R 2916	CHIP RES.	10k	1/16W	5%	RMC1/16 103JATP	J24185103		1-	A	
R 2917	CHIP RES.	10k	1/16W	5%	RMC1/16 103JATP	J24185103		1-	A	
R 2918	CHIP RES.	47k	1/16W	5%	RMC1/16 473JATP	J24185473		1-	A	
R 2919	CHIP RES.	10k	1/16W	5%	RMC1/16 103JATP	J24185103		1-	A	
R 2920	CHIP RES.	47k	1/16W	5%	RMC1/16 473JATP	J24185473		1-	A	
R 2921	CHIP RES.	10k	1/16W	5%	RMC1/16 103JATP	J24185103		1-	A	
R 2923	CHIP RES.	47k	1/16W	5%	RMC1/16 473JATP	J24185473		1-	A	
R 2924	CHIP RES.	10k	1/16W	5%	RMC1/16 103JATP	J24185103		1-	A	
R 2925	CHIP RES.	3.3k	1/16W	5%	RMC1/16 332JATP	J24185332		1-	A	
VR2901	POT.	10k			RH03A3A14X 10K	J51807103		1-	A	

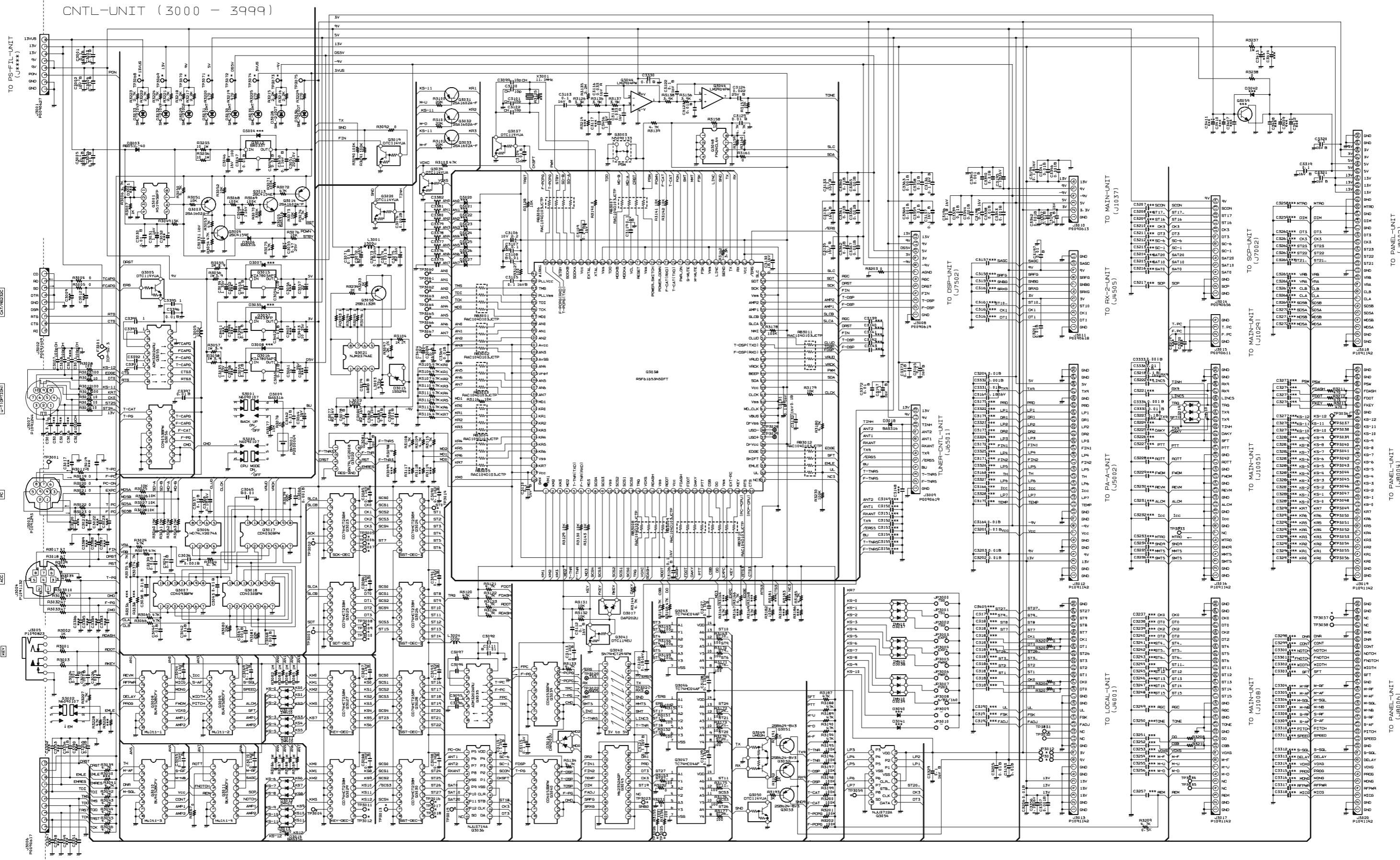

CNTL Unit (Lot. 1)

Note

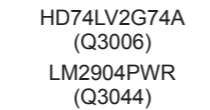
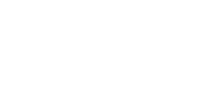
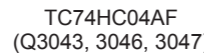
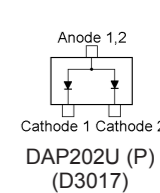
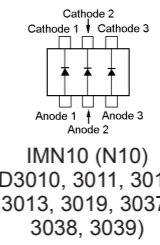
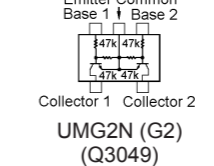
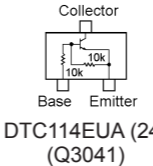
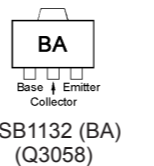
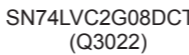
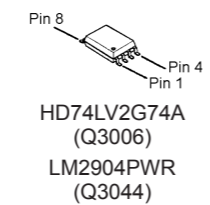
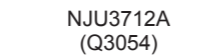
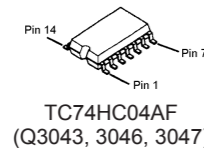
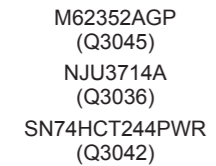
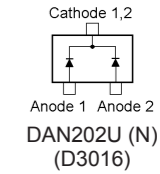
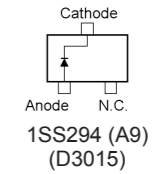
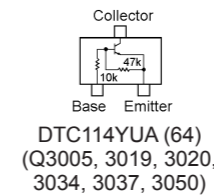
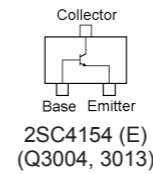
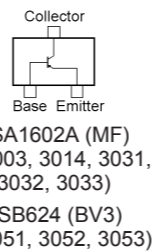
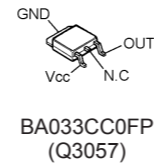
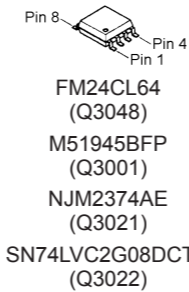
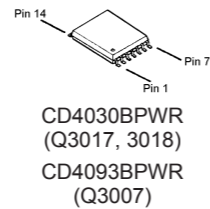
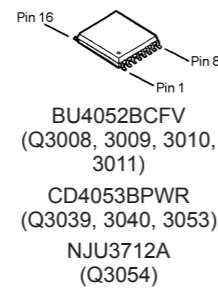
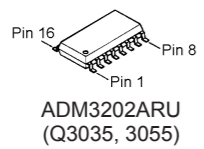
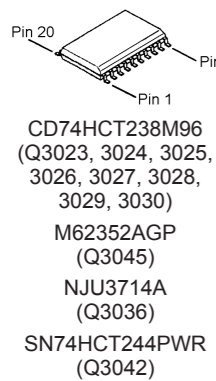
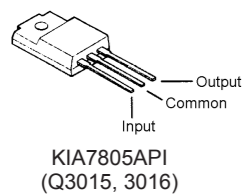
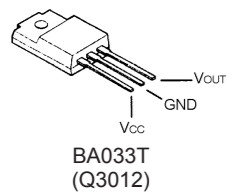
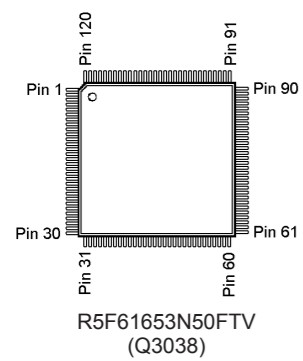
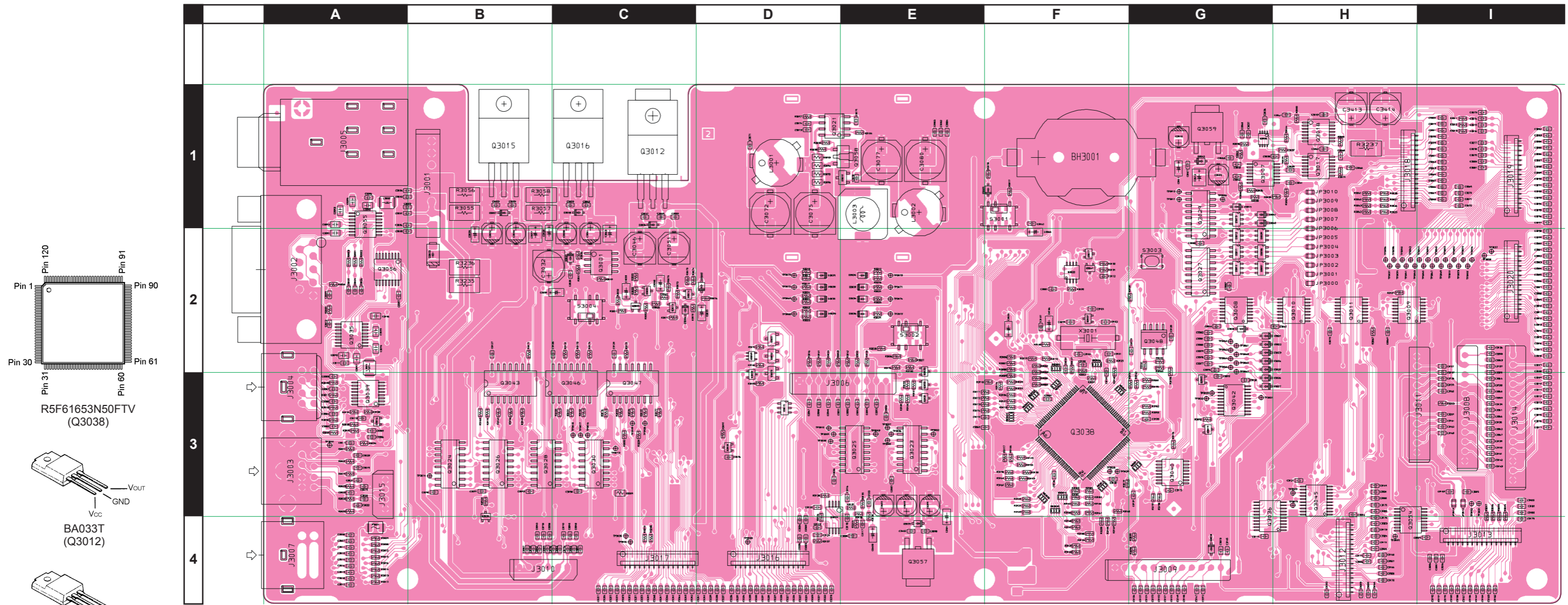

CNTL Unit (Lot. 1)

Parts Layout (Side B)

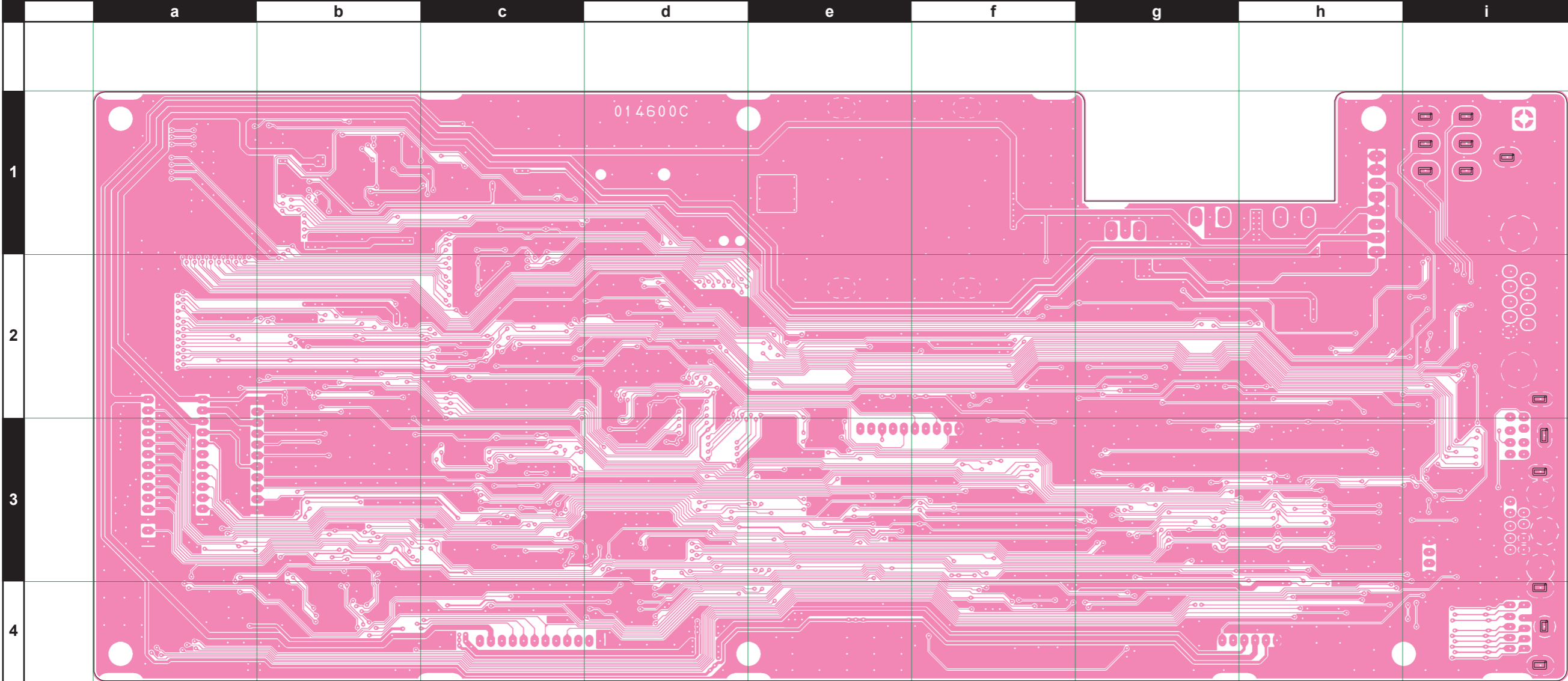

CNTL Unit (Lot. 2~)

Note

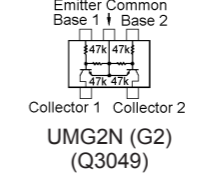
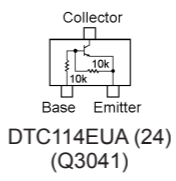
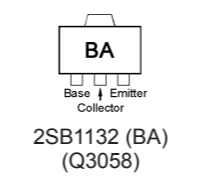
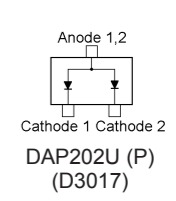
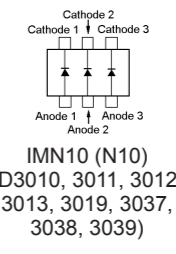
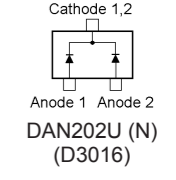
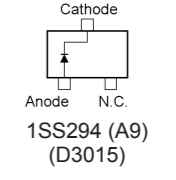
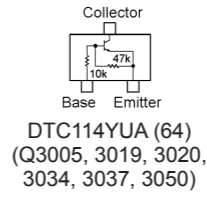
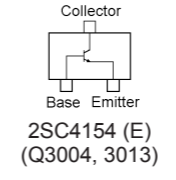
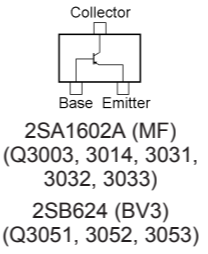
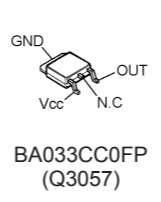
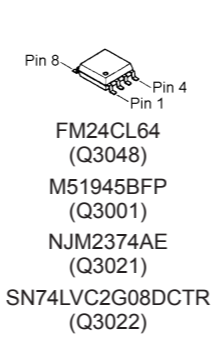
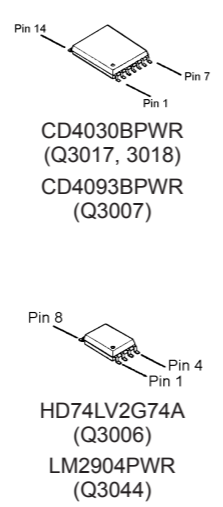
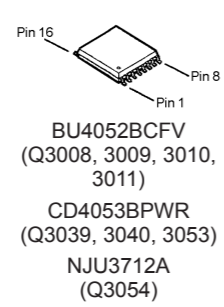
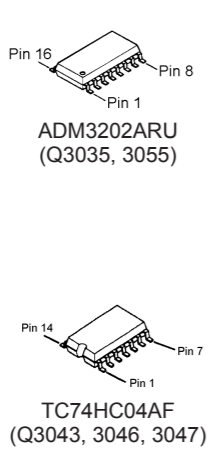
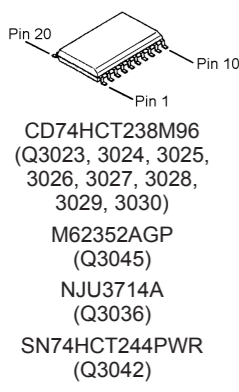
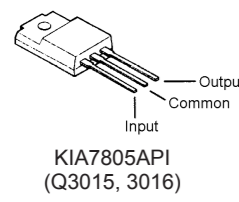
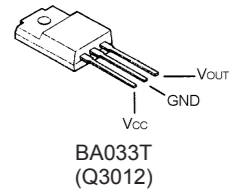
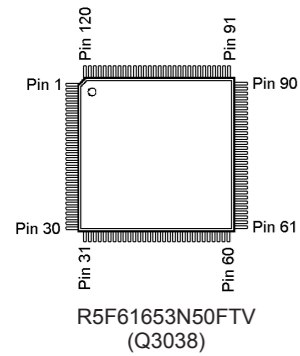
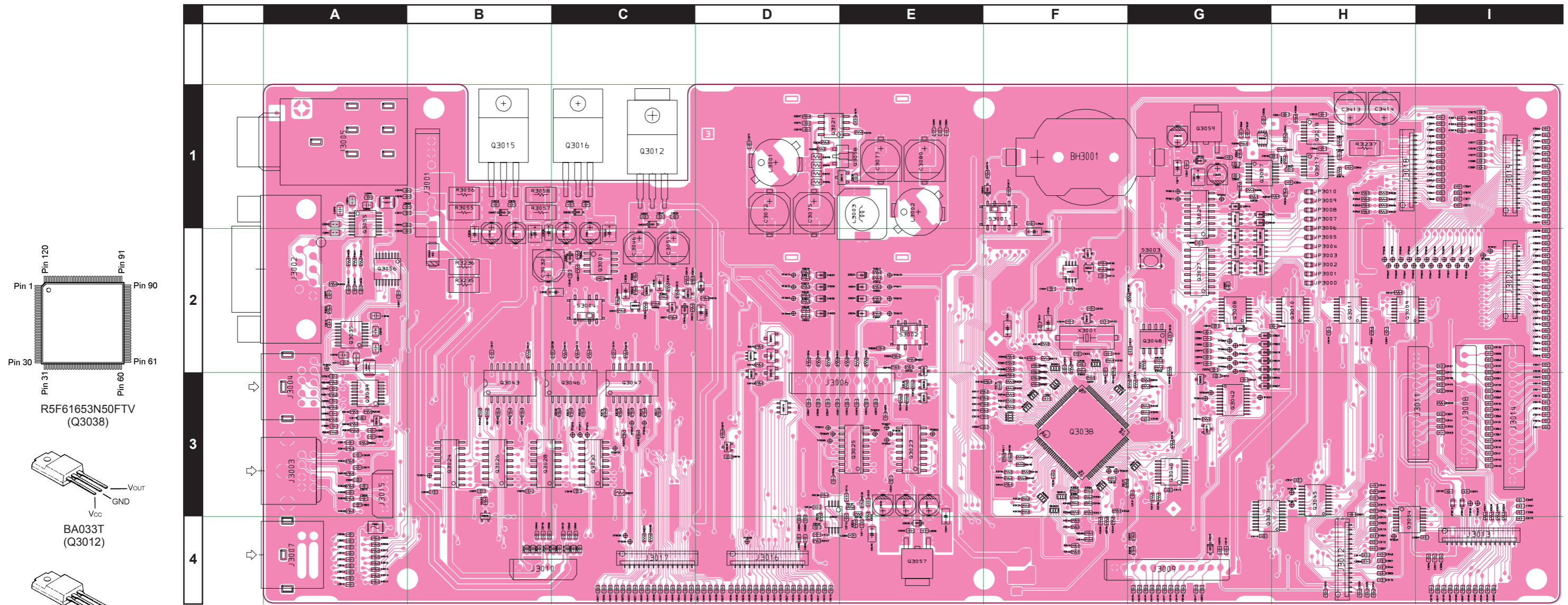

CNTL Unit (Lot. 2~)

Parts Layout (Side B)

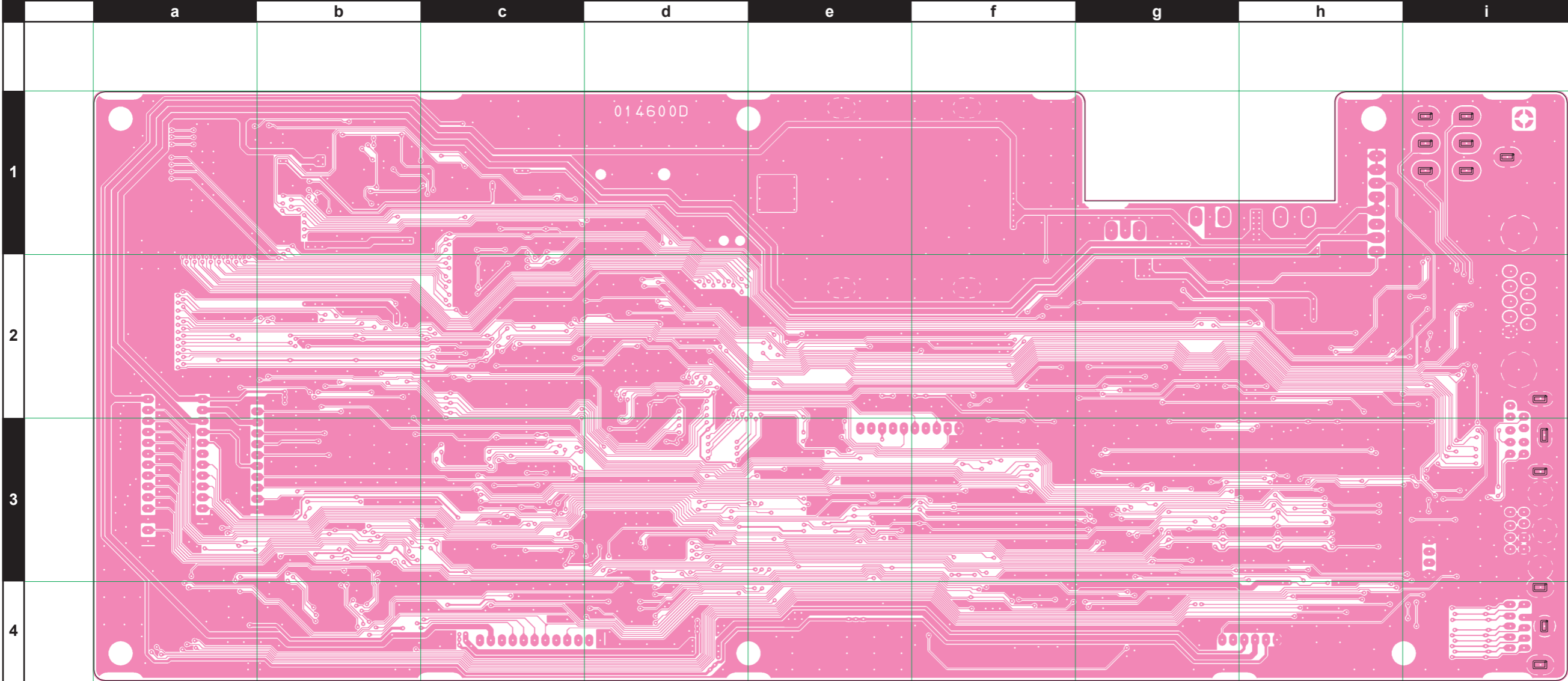

REF	DESCRIPTION	VALUE	V/W	TOL.	MFR'S DESIG	VXSTD P/N	VERS.	LOT	SIDE	LAY ADR
	PCB with Components					CS1893001				
						CS1893002				
						CS1893003				
						CS1893004				
						CS1893005				
						CS1893006				
						CS1893007				
						CS1893008				
						CS1893009				
	Printed Circuit Board					FR014600C		1		
						FR014600D		2-		
BH3001	BATT.HOLDER				20H-1T	P2000069		1-	A	F1
BT3001	LITHIUM BATT.		3V		CR2032	Q9000564		1-		
C 3001	CHIP CAP.	0.1uF	16V	B	GRM188B11C104KA01D	K22124805		1-	A	A1
C 3002	CHIP CAP.	0.1uF	16V	B	GRM188B11C104KA01D	K22124805		1-	A	A1
C 3003	CHIP CAP.	0.01uF	50V	B	GRM188B11H103KA01D	K22174823		1-	A	A1
C 3004	CHIP CAP.	0.01uF	50V	B	GRM188B11H103KA01D	K22174823		1-	A	A1
C 3005	CHIP CAP.	0.1uF	16V	B	GRM188B11C104KA01D	K22124805		1-	A	A2
C 3006	CHIP CAP.	0.01uF	50V	B	GRM188B11H103KA01D	K22174823		1-	A	A1
C 3007	CHIP CAP.	100pF	50V	CH	GRM1882C1H101JA01D	K22174235		1-	A	A4
C 3008	CHIP CAP.	100pF	50V	CH	GRM1882C1H101JA01D	K22174235		1-	A	A4
C 3011	CHIP CAP.	100pF	50V	CH	GRM1882C1H101JA01D	K22174235		1-	A	A4
C 3013	CHIP CAP.	0.01uF	50V	B	GRM188B11H103KA01D	K22174823		1-	A	A4
C 3018	CHIP CAP.	100pF	50V	CH	GRM1882C1H101JA01D	K22174235		1-	A	A4
C 3024	CHIP CAP.	0.001uF	50V	B	GRM188B11H102KA01D	K22174821		1-	A	A2
C 3025	CHIP CAP.	0.001uF	50V	B	GRM188B11H102KA01D	K22174821		1-	A	A2
C 3026	CHIP CAP.	0.001uF	50V	B	GRM188B11H102KA01D	K22174821		1-	A	A2
C 3030	CHIP CAP.	0.01uF	50V	B	GRM188B11H103KA01D	K22174823		1-	A	C2
C 3031	CHIP TA.CAP.	1uF	16V		TESVA1C105M1-8R	K78120009		1-	A	C2
C 3033	CHIP TA.CAP.	1uF	16V		TESVA1C105M1-8R	K78120009		1-	A	C2
C 3034	CHIP TA.CAP.	1uF	35V		TEMSVA1V105M-8R	K78160032		1-	A	B2
C 3035	CHIP TA.CAP.	1uF	35V		TEMSVA1V105M-8R	K78160032		1-	A	B2
C 3036	CHIP CAP.	0.001uF	50V	B	GRM188B11H102KA01D	K22174809		1-	A	G1
C 3037	CHIP CAP.	0.01uF	50V	B	GRM188B11H103KA01D	K22174823		1-	A	G1
C 3038	CHIP CAP.	0.01uF	50V	B	GRM188B11H103KA01D	K22174823		1-	A	H1
C 3039	CHIP CAP.	0.01uF	50V	B	GRM188B11H103KA01D	K22174823		1-	A	H1
C 3040	CHIP CAP.	0.01uF	50V	B	GRM188B11H103KA01D	K22174823		1-	A	G1
C 3041	CHIP CAP.	0.01uF	50V	B	GRM188B11H103KA01D	K22174823		1-	A	H1
C 3042	CHIP CAP.	0.01uF	50V	B	GRM188B11H103KA01D	K22174823		1-	A	G1
C 3043	CHIP CAP.	0.01uF	50V	B	GRM188B11H103KA01D	K22174823		1-	A	H1
C 3044	CHIP CAP.	0.1uF	16V	B	GRM188B11C104KA01D	K22124805		1-	A	G2
C 3045	CHIP CAP.	0.1uF	16V	B	GRM188B11C104KA01D	K22124805		1-	A	H2
C 3046	AL.ELECTRO.CAP.	100uF	16V		EEE1CA101WP	K48120012		1-	A	C1
C 3047	CHIP CAP.	0.01uF	50V	B	GRM188B11H103KA01D	K22174823		1-	A	C2
C 3048	CHIP TA.CAP.	1uF	16V		TESVA1C105M1-8R	K78120009		1-	A	C2
C 3049	CHIP CAP.	0.01uF	50V	B	GRM188B11H103KA01D	K22174823		1-	A	C1
C 3050	CHIP CAP.	0.1uF	16V	B	GRM188B11C104KA01D	K22124805		1-	A	C1
C 3051	AL.ELECTRO.CAP.	220uF	10V		EEE1AA221XP	K48100007		1-	A	C2
C 3053	CHIP CAP.	0.01uF	50V	B	GRM188B11H103KA01D	K22174823		1-	A	B1
C 3054	CHIP CAP.	0.01uF	50V	B	GRM188B11H103KA01D	K22174823		1-	A	B1
C 3055	CHIP TA.CAP.	0.47uF	25V		TESVA1E474M1-8R	K78140009		1-	A	D2
C 3057	CHIP TA.CAP.	22uF			TPSB226M016Y0600	K78120075		1-	A	B2
C 3059	CHIP CAP.	0.01uF	50V	B	GRM188B11H103KA01D	K22174823		1-	A	C1
C 3060	CHIP CAP.	0.01uF	50V	B	GRM188B11H103KA01D	K22174823		1-	A	C1
C 3061	AL.ELECTRO.CAP.	10uF	35V		EEE1VA100WR	K48160006		1-	A	C2
C 3062	CHIP CAP.	0.01uF	50V	B	GRM188B11H103KA01D	K22174823		1-	A	F1
C 3064	CHIP TA.CAP.	1uF	16V		TESVA1C105M1-8R	K78120009		1-	A	F2
C 3065	CHIP CAP.	0.01uF	50V	B	GRM188B11H103KA01D	K22174823		1-	A	H1
C 3066	CHIP CAP.	0.001uF	50V	B	GRM188B11H102KA01D	K22174809		1-	A	H1
C 3067	CHIP CAP.	0.001uF	50V	B	GRM188B11H102KA01D	K22174809		1-	A	H1
C 3068	CHIP CAP.	0.001uF	50V	B	GRM188B11H102KA01D	K22174809		1-	A	H1
C 3069	CHIP CAP.	0.1uF	16V	B	GRM188B11C104KA01D	K22124805		1-	A	H2
C 3070	CHIP CAP.	0.1uF	16V	B	GRM188B11C104KA01D	K22124805		1-	A	H2
C 3071	CHIP CAP.	0.01uF	50V	B	GRM188B11H103KA01D	K22174823		1-	A	D1
C 3072	AL.ELECTRO.CAP.	82uF	16V		PXA16VC82MH70	K48120022		1-	A	D1
C 3073	CHIP CAP.	0.1uF	16V	B	GRM188B11C104KA01D	K22124805		1-	A	D1
C 3074	CHIP CAP.	0.001uF	50V	B	GRM188B11H102KA01D	K22174821		1-	A	D1
C 3075	AL.ELECTRO.CAP.	82uF	16V		PXA16VC82MH70	K48120022		1-	A	D1
C 3076	CHIP CAP.	0.001uF	50V	B	GRM188B11H102KA01D	K22174821		1-	A	D3
C 3077	AL.ELECTRO.CAP.	82uF	16V		PXA16VC82MH70	K48120022		1-	A	E1
C 3078	CHIP CAP.	0.01uF	50V	B	GRM188B11H103KA01D	K22174823		1-	A	E1
C 3079	CHIP CAP.	680pF	50V	B	GRM188B11H681KA01D	K22174807		1-	A	E1
C 3080	AL.ELECTRO.CAP.	82uF	16V		PXA16VC82MH70	K48120022		1-	A	E1

CNTL Unit

Parts List

REF	DESCRIPTION	VALUE	V/W	TOL.	MFR'S DESIG	VXSTD P/N	VERS.	LOT	SIDE	LAY ADR
C 3081	CHIP CAP.	0.1uF	16V	B	GRM188B11C104KA01D	K22124805		1-	A	F2
C 3082	CHIP CAP.	0.1uF	16V	B	GRM188B11C104KA01D	K22124805		1-	A	E1
C 3083	CHIP CAP.	0.01uF	50V	B	GRM188B11H103KA01D	K22174823		1-	A	E1
C 3084	CHIP CAP.	0.001uF	50V	B	GRM188B11H102KA01D	K22174821		1-	A	E1
C 3085	CHIP CAP.	0.1uF	16V	B	GRM188B11C104KA01D	K22124805		1-	A	E3
C 3086	CHIP CAP.	0.1uF	16V	B	GRM188B11C104KA01D	K22124805		1-	A	D3
C 3087	CHIP CAP.	0.1uF	16V	B	GRM188B11C104KA01D	K22124805		1-	A	G2
C 3088	CHIP CAP.	0.1uF	16V	B	GRM188B11C104KA01D	K22124805		1-	A	G2
C 3089	CHIP CAP.	0.1uF	16V	B	GRM188B11C104KA01D	K22124805		1-	A	F3
C 3090	CHIP CAP.	0.1uF	16V	B	GRM188B11C104KA01D	K22124805		1-	A	B3
C 3091	CHIP CAP.	0.1uF	16V	B	GRM188B11C104KA01D	K22124805		1-	A	B3
C 3092	CHIP CAP.	1uF			GRM21BB11C105KA01L	K22120809		1-	A	A2
C 3093	CHIP CAP.	0.1uF	16V	B	GRM188B11C104KA01D	K22124805		1-	A	B3
C 3094	CHIP CAP.	1uF			GRM21BB11C105KA01L	K22120809		1-	A	A2
C 3095	CHIP CAP.	1uF			GRM21BB11C105KA01L	K22120809		1-	A	A2
C 3096	CHIP CAP.	1uF			GRM21BB11C105KA01L	K22120809		1-	A	A2
C 3097	CHIP CAP.	1uF			GRM21BB11C105KA01L	K22120809		1-	A	A2
C 3098	CHIP CAP.	0.1uF	16V	B	GRM188B11C104KA01D	K22124805		1-	A	C3
C 3099	CHIP CAP.	10pF	50V	CH	GRM1882C1H100JA01D	K22174211		1-	A	F2
C 3100	CHIP CAP.	10pF	50V	CH	GRM1882C1H100JA01D	K22174211		1-	A	F2
C 3101	CHIP CAP.	10pF	50V	CH	GRM1882C1H100JA01D	K22174211		1-	A	F2
C 3102	CHIP CAP.	10pF	50V	CH	GRM1882C1H100JA01D	K22174211		1-	A	F2
C 3103	CHIP CAP.	0.1uF	16V	B	GRM188B11C104KA01D	K22124805		1-	A	E3
C 3103	CHIP RES.	0	1/16W	5%	RMC1/16 000JATP	J24185000		4-	A	E3
C 3104	CHIP CAP.	0.01uF	50V	B	GRM188B11H103KA01D	K22174823		1-	A	F2
C 3105	CHIP CAP.	0.1uF	16V	B	GRM188B11C104KA01D	K22124805		1-	A	F2
C 3106	CHIP TA.CAP.	2.2uF	10V		TESVA1A225M1-8R	K78100021		1-	A	F2
C 3107	CHIP CAP.	0.1uF	16V	B	GRM188B11C104KA01D	K22124805		1-	A	F2
C 3108	CHIP CAP.	0.01uF	50V	B	GRM188B11H103KA01D	K22174823		1-	A	F2
C 3109	CHIP CAP.	0.1uF	16V	B	GRM188B11C104KA01D	K22124805		1-	A	F2
C 3110	CHIP CAP.	0.1uF	16V	B	GRM188B11C104KA01D	K22124805		1-	A	F3
C 3111	CHIP CAP.	0.01uF	50V	B	GRM188B11H103KA01D	K22174823		1-	A	A2
C 3112	CHIP CAP.	0.1uF	16V	B	GRM188B11C104KA01D	K22124805		1-	A	F2
C 3113	CHIP CAP.	0.1uF	16V	B	GRM188B11C104KA01D	K22124805		1-	A	A3
C 3114	CHIP CAP.	0.1uF	16V	B	GRM188B11C104KA01D	K22124805		1-	A	G4
C 3115	CHIP CAP.	0.1uF	16V	B	GRM188B11C104KA01D	K22124805		1-	A	G3
C 3116	CHIP CAP.	0.033uF	16V	R	GRM188R11C333KA01D	K22124801		1-	A	E3
C 3118	CHIP CAP.	0.033uF	16V	R	GRM188R11C333KA01D	K22124801		1-	A	E4
C 3119	CHIP CAP.	0.1uF	16V	B	GRM188B11C104KA01D	K22124805		1-	A	G2
C 3120	CHIP CAP.	0.1uF	16V	B	GRM188B11C104KA01D	K22124805		1-	A	G3
C 3121	CHIP CAP.	0.1uF	16V	B	GRM188B11C104KA01D	K22124805		1-	A	H3
C 3122	CHIP CAP.	0.1uF	16V	B	GRM188B11C104KA01D	K22124805		1-	A	D3
C 3123	CHIP CAP.	0.01uF	50V	B	GRM188B11H103KA01D	K22174823		1-	A	D4
C 3124	CHIP CAP.	0.022uF	25V	B	GRM39B223K25PT	K22144807		1-	A	D4
C 3125	CHIP CAP.	0.01uF	50V	B	GRM188B11H103KA01D	K22174823		1-	A	G2
C 3126	CHIP CAP.	0.1uF	16V	B	GRM188B11C104KA01D	K22124805		1-	A	F3
C 3127	CHIP CAP.	0.1uF	16V	B	GRM188B11C104KA01D	K22124805		1-	A	B2
C 3128	CHIP CAP.	0.1uF	16V	B	GRM188B11C104KA01D	K22124805		1-	A	C2
C 3129	CHIP CAP.	0.1uF	16V	B	GRM188B11C104KA01D	K22124805		1-	A	C2
C 3130	CHIP CAP.	0.1uF	16V	B	GRM188B11C104KA01D	K22124805		1-	A	G3
C 3131	CHIP CAP.	0.1uF	16V	B	GRM188B11C104KA01D	K22124805		1-	A	G3
C 3132	CHIP CAP.	0.1uF	16V	B	GRM188B11C104KA01D	K22124805		1-	A	F3
C 3133	CHIP CAP.	0.1uF	16V	B	GRM188B11C104KA01D	K22124805		1-	A	I3
C 3134	CHIP CAP.	0.1uF	16V	B	GRM188B11C104KA01D	K22124805		1-	A	I3
C 3135	CHIP CAP.	0.1uF	16V	B	GRM188B11C104KA01D	K22124805		1-	A	I3
C 3136	CHIP CAP.	0.1uF	16V	B	GRM188B11C104KA01D	K22124805		1-	A	I2
C 3137	CHIP CAP.	0.1uF	16V	B	GRM188B11C104KA01D	K22124805		1-	A	I2
C 3145	CHIP CAP.	0.1uF	16V	B	GRM188B11C104KA01D	K22124805		1-	A	G4
C 3147	CHIP CAP.	0.1uF	16V	B	GRM188B11C104KA01D	K22124805		1-	A	G4
C 3164	CHIP CAP.	0.01uF	50V	B	GRM188B11H103KA01D	K22174823		1-	A	H4
C 3169	CHIP CAP.	0.1uF	16V	B	GRM188B11C104KA01D	K22124805		1-	A	H3
C 3193	CHIP CAP.	0.01uF	50V	B	GRM188B11H103KA01D	K22174823		1-	A	I3
C 3194	CHIP CAP.	0.1uF	16V	B	GRM188B11C104KA01D	K22124805		1-	A	C4
C 3195	CHIP CAP.	0.1uF	16V	B	GRM188B11C104KA01D	K22124805		1-	A	C4
C 3196	CHIP CAP.	0.1uF	16V	B	GRM188B11C104KA01D	K22124805		1-	A	C4
C 3197	CHIP CAP.	0.01uF	50V	B	GRM188B11H103KA01D	K22174823		1-	A	I2
C 3198	CHIP CAP.	0.1uF	16V	B	GRM188B11C104KA01D	K22124805		1-	A	B4
C 3199	CHIP CAP.	0.1uF	16V	B	GRM188B11C104KA01D	K22124805		1-	A	B4
C 3200	CHIP CAP.	0.01uF	50V	B	GRM188B11H103KA01D	K22174823		1-	A	H4
C 3201	CHIP CAP.	0.01uF	50V	B	GRM188B11H103KA01D	K22174823		1-	A	I3
C 3202	CHIP CAP.	0.01uF	50V	B	GRM188B11H103KA01D	K22174823		1-	A	H4
C 3203	CHIP CAP.	0.01uF	50V	B	GRM188B11H103KA01D	K22174823		1-	A	H4
C 3204	CHIP CAP.	0.01uF	50V	B	GRM188B11H103KA01D	K22174823		1-	A	H3

CNTL Unit

Parts List

REF	DESCRIPTION	VALUE	V/W	TOL.	MFR'S DESIG	VXSTD P/N	VERS.	LOT	SIDE	LAY ADR
C 3402	CHIP CAP.	0.01uF	50V	B	GRM188B11H103KA01D	K22174823		1-	A	E4
C 3403	AL.ELECTRO.CAP.	10uF	35V		EEE1VA100WR	K48160006		1-	A	E3
C 3404	CHIP TA.CAP.	1uF	16V		TESVA1C105M1-8R	K78120009		1-	A	F2
C 3406	CHIP TA.CAP.	1uF	16V		TESVA1C105M1-8R	K78120009		1-	A	E4
C 3415	CHIP CAP.	0.22uF	10V	B	GRM188B11A224KA01D	K22104801		3-		
D 3003	DIODE				RB051L-40TE25	G2070718		1-	A	B2
D 3005	DIODE				BAS316	G2070716		1-	A	D2
D 3006	DIODE				BAS316	G2070716		1-	A	C2
D 3009	DIODE				BAS316	G2070716		1-	A	F1
D 3010	DIODE				IMN10 T108	G2070078		1-	A	G2
D 3011	DIODE				IMN10 T108	G2070078		1-	A	G2
D 3012	DIODE				IMN10 T108	G2070078		1-	A	G2
D 3013	DIODE				IMN10 T108	G2070078		1-	A	G1
D 3014	DIODE				BAS316	G2070716		1-	A	G1
D 3015	DIODE				1SS294(TE85R.F)	G2070058		1-	A	E1
D 3016	DIODE				DAN202U T106	G2070162		1-	A	A3
D 3017	DIODE				DAP202U T106	G2070160		1-	A	F2
D 3018	DIODE				BAS316	G2070716		1-	A	G4
D 3019	DIODE				IMN10 T108	G2070078		1-	A	D3
D 3033	LED				SML-210VTT86	G2070768		2-	A	D2
D 3037	DIODE				IMN10 T108	G2070078		1-	A	G2
D 3038	DIODE				IMN10 T108	G2070078		1-	A	G2
D 3039	DIODE				IMN10 T108	G2070078		1-	A	G2
F 3001	PROTECTOR				ICP-S2.3TN	G9090144		1-	A	A4
FB3001	FERRITE BEADS				BK1608HS601-T	L9190083		4-		
J 3001	CONNECTOR				SC25-08WS	P0090627		1-	A	B1
J 3002	CONNECTOR				XM2C-0942-232L	P0091409		1-	A	A2
J 3003	CONNECTOR				M50-08-30-434S R41-0599M	P1091132		1-	A	A3
J 3004	CONNECTOR				TCS7709	P1091293		1-	A	A3
J 3005	CONNECTOR				HLJ2305-0130609	P1090823		1-	A	A1
J 3007	CONNECTOR				TCS7705-5120177	P1091244		1-	A	A4
J 3008	CONNECTOR				SB20-12WS	P0090619		1-	A	I3
J 3009	CONNECTOR				SB20-12WS	P0090619		1-	A	F4
J 3010	CONNECTOR				SB20-06WS	P0090613		1-	A	B4
J 3011	CONNECTOR				SB20-11WS	P0090618		1-	A	I3
J 3012	CONNECTOR				30FLT-SM1-TB	P1091142		1-	A	H4
J 3013	CONNECTOR				30FLT-SM1-TB	P1091142		1-	A	I4
J 3014	CONNECTOR				SB20-14WS	P0090656		1-	A	I3
J 3015	CONNECTOR				SB20-04WS	P0090611		1-	A	A3
J 3016	CONNECTOR				30FLT-SM1-TB	P1091142		1-	A	D4
J 3017	CONNECTOR				30FLT-SM1-TB	P1091142		1-	A	C4
J 3018	CONNECTOR				30FLT-SM1-TB	P1091142		1-	A	H1
J 3019	CONNECTOR				30FLT-SM1-TB	P1091142		1-	A	I1
J 3020	CONNECTOR				30FLT-SM1-TB	P1091142		1-	A	I2
JP3000	CHIP RES.	0	1/16W	5%	RMC1/16 000JATP	J24185000	EUROPE	4-	A	H2
JP3001	CHIP RES.	0	1/16W	5%	RMC1/16 000JATP	J24185000	AUSTRALIA	4-	A	H2
JP3001	CHIP RES.	0	1/16W	5%	RMC1/16 000JATP	J24185000	EUROPE	4-	A	H2
JP3001	CHIP RES.	0	1/16W	5%	RMC1/16 000JATP	J24185000	EXPORT	4-	A	H2
JP3001	CHIP RES.	0	1/16W	5%	RMC1/16 000JATP	J24185000	UNITED KINGDOM	4-	A	H2
JP3002	CHIP RES.	0	1/16W	5%	RMC1/16 000JATP	J24185000	AUSTRALIA	4-	A	H2
JP3002	CHIP RES.	0	1/16W	5%	RMC1/16 000JATP	J24185000	EXPORT	4-	A	H2
JP3002	CHIP RES.	0	1/16W	5%	RMC1/16 000JATP	J24185000	FRANCE	4-	A	H2
JP3005	CHIP RES.	0	1/16W	5%	RMC1/16 000JATP	J24185000		4-	A	H2
JP3006	CHIP RES.	0	1/16W	5%	RMC1/16 000JATP	J24185000		4-	A	H2
JP3007	CHIP RES.	0	1/16W	5%	RMC1/16 000JATP	J24185000		4-	A	H1
JP3100	WIRE ASSY				GRN 145 2/2	T50514500		1		
JP3101	WIRE ASSY				GRN 60 2/2	T50506000		1-2		
L 3001	CHIP COIL	1500uH			A814AY-152K=P3	L1691320		1-	A	D1
L 3002	CHIP COIL	1500uH			A814AY-152K=P3	L1691320		1-	A	E1
L 3003	M.RFC	470uH			CDRH105RNP-471NC-VS	L1691359		1-	A	E1
L 3004	M.RFC	100uH			FLC32T-101J	L1690227		1-	A	A2
L 3005	M.RFC	100uH			FLC32T-101J	L1690227		1-	A	A1
Q 3001	IC				M51945BFP-600C	G1091990		1-	A	C2
Q 3003	TRANSISTOR				2SA1602A-T11-1F	G3116028F		1-	A	C2
Q 3004	TRANSISTOR				2SC4154-T11-1E	G3341548E		1-	A	C2
Q 3005	TRANSISTOR				DTC114YUA T106	G3070298		1-	A	G3
Q 3006	IC				HD74LV2G74A(TAPE)	G1093788		1-	A	G1
Q 3007	IC				CD4093BPWR	G1094093		1-	A	G1
Q 3008	IC				BU4052BCFV-E2	G1094196		1-	A	G2
Q 3009	IC				BU4052BCFV-E2	G1094196		1-	A	H2
Q 3010	IC				BU4052BCFV-E2	G1094196		1-	A	H2
Q 3011	IC				BU4052BCFV-E2	G1094196		1-	A	H2
Q 3012	IC				BA033T	G1093776		1-	A	C1

CNTL Unit

Parts List

REF	DESCRIPTION	VALUE	V/W	TOL.	MFR'S DESIG	VXSTD P/N	VERS.	LOT	SIDE	LAY ADR
Q 3013	TRANSISTOR				2SC4154-T11-1E	G3341548E		1-	A	C2
Q 3014	TRANSISTOR				2SA1602A-T11-1F	G3116028F		1-	A	C2
Q 3015	IC				KIA7805API	G1093163		1-	A	B1
Q 3016	IC				KIA7805API	G1093163		1-	A	C1
Q 3017	IC				CD4030BPWR	G1094092		1-	A	H1
Q 3018	IC				CD4030BPWR	G1094092		1-	A	H1
Q 3019	TRANSISTOR				DTC114YUA T106	G3070298		1-	A	G3
Q 3020	TRANSISTOR				DTC114YUA T106	G3070298		1-	A	D3
Q 3021	IC				NJM2374AE-TE1	G1093808		1-	A	D1
Q 3022	IC				SN74LVC2G08DCTR	G1094341		1-	A	F2
Q 3023	IC				CD74HCT238M96	G1093850		1-	A	E3
Q 3024	IC				CD74HCT238M96	G1093850		1-	A	B3
Q 3025	IC				CD74HCT238M96	G1093850		1-	A	E3
Q 3026	IC				CD74HCT238M96	G1093850		1-	A	B3
Q 3027	IC				CD74HCT238M96	G1093850		1-	A	G2
Q 3028	IC				CD74HCT238M96	G1093850		1-	A	B3
Q 3029	IC				CD74HCT238M96	G1093850		1-	A	G1
Q 3030	IC				CD74HCT238M96	G1093850		1-	A	C3
Q 3031	TRANSISTOR				2SA1602A-T11-1F	G3116028F		1-	A	E3
Q 3032	TRANSISTOR				2SA1602A-T11-1F	G3116028F		1-	A	E3
Q 3033	TRANSISTOR				2SA1602A-T11-1F	G3116028F		1-	A	E2
Q 3034	TRANSISTOR				DTC114YUA T106	G3070298		1-	A	B3
Q 3035	IC				ADM3202ARU	G1094022		1-	A	A2
Q 3036	IC				NJU3714A(TAPE)	G1094291		1-	A	G3
Q 3037	TRANSISTOR				DTC114YUA T106	G3070298		1-	A	F2
Q 3038	IC				R5F61653N50FTV	×		1-	A	F3
Q 3039	IC				CD4053BPWR	G1093864		1-	A	A3
Q 3040	IC				CD4053BPWR	G1093864		1-	A	G3
Q 3041	TRANSISTOR				DTC114EUA T106	G3070084		1-	A	F2
Q 3042	IC				SN74HCT244PWR	G1094091		1-	A	G3
Q 3043	IC				TC74HC04AF(EL.F)	G1093499		1-	A	B3
Q 3044	IC				LM2904PWR	G1094010		1-	A	D4
Q 3045	IC				M62352AGP	G1094271		1-	A	H3
Q 3046	IC				TC74HC04AF(EL.F)	G1093499		1-	A	C3
Q 3047	IC				TC74HC04AF(EL.F)	G1093499		1-	A	C3
Q 3048	IC				FM24CL64	G1094270		1-	A	G2
Q 3049	TRANSISTOR				UMG2N TR	G3070088		1-	A	D2
Q 3050	TRANSISTOR				DTC114YUA T106	G3070298		1-	A	D3
Q 3051	TRANSISTOR				2SB624-T2B BV3	G3206247C		1-	A	D2
Q 3052	TRANSISTOR				2SB624-T2B BV3	G3206247C		1-	A	D2
Q 3053	TRANSISTOR				2SB624-T2B BV3	G3206247C		1-	A	D3
Q 3054	IC				NJU3712A(TAPE)	G1094290		1-	A	H4
Q 3055	IC				ADM3202ARU	G1094022		1-	A	A1
Q 3056	IC				CD4053BPWR	G1093864		1-	A	A2
Q 3057	IC				BA033CC0FP-E2	G1094077		1-	A	E4
Q 3058	TRANSISTOR				2SB1132 T100 R	G3211327R		1-	A	E1
R 3001	CHIP RES.	1k	1/16W	5%	RMC1/16 102JATP	J24185102		1-	A	A2
R 3002	CHIP RES.	1k	1/16W	5%	RMC1/16 102JATP	J24185102		1-	A	A2
R 3003	CHIP RES.	1k	1/16W	5%	RMC1/16 102JATP	J24185102		1-	A	A2
R 3004	CHIP RES.	0	1/16W	5%	RMC1/16 000JATP	J24185000		1-	A	A2
R 3005	CHIP RES.	0	1/16W	5%	RMC1/16 000JATP	J24185000		1-	A	A2
R 3006	CHIP RES.	4.7k	1/16W	5%	RMC1/16 472JATP	J24185472		1-	A	C2
R 3007	CHIP RES.	1k	1/16W	5%	RMC1/16 102JATP	J24185102		1-	A	C2
R 3008	CHIP RES.	100	1/16W	5%	RMC1/16 101JATP	J24185101		1-	A	A4
R 3009	CHIP RES.	100	1/16W	5%	RMC1/16 101JATP	J24185101		1-	A	A4
R 3010	CHIP RES.	10	1/16W	5%	RMC1/16 100JATP	J24185100		1-	A	A4
R 3011	CHIP RES.	0	1/16W	5%	RMC1/16 000JATP	J24185000		1-	A	A3
R 3012	CHIP RES.	100	1/16W	5%	RMC1/16 101JATP	J24185101		1-	A	A4
R 3013	CHIP RES.	100	1/16W	5%	RMC1/16 101JATP	J24185101		1-	A	A4
R 3014	CHIP RES.	10	1/16W	5%	RMC1/16 100JATP	J24185100		1-	A	A4
R 3015	CHIP RES.	10	1/16W	5%	RMC1/16 100JATP	J24185100		1-	A	A4
R 3016	CHIP RES.	10	1/16W	5%	RMC1/16 100JATP	J24185100		1-	A	A4
R 3017	CHIP RES.	47	1/16W	5%	RMC1/16 470JATP	J24185470		1-	A	A3
R 3018	CHIP RES.	47	1/16W	5%	RMC1/16 470JATP	J24185470		1-	A	A3
R 3019	CHIP RES.	0	1/16W	5%	RMC1/16 000JATP	J24185000		1-	A	A3
R 3020	CHIP RES.	0	1/16W	5%	RMC1/16 000JATP	J24185000		1-	A	A3
R 3021	CHIP RES.	0	1/16W	5%	RMC1/16 000JATP	J24185000		1-	A	A3
R 3022	CHIP RES.	0	1/16W	5%	RMC1/16 000JATP	J24185000		1-	A	A3
R 3023	CHIP RES.	0	1/16W	5%	RMC1/16 000JATP	J24185000		1-	A	A3
R 3024	CHIP RES.	47k	1/16W	5%	RMC1/16 473JATP	J24185473		1-	A	H1
R 3025	CHIP RES.	10k	1/16W	5%	RMC1/16 103JATP	J24185103		1-	A	H1
R 3026	CHIP RES.	10k	1/16W	5%	RMC1/16 103JATP	J24185103		1-	A	H1
R 3027	CHIP RES.	10k	1/16W	5%	RMC1/16 103JATP	J24185103		1-	A	H1

×: Please contact Vertex Standard

CNTL Unit

Parts List

REF	DESCRIPTION	VALUE	V/W	TOL.	MFR'S DESIG	VXSTD P/N	VERS.	LOT	SIDE	LAY ADR
R 3028	CHIP RES.	10k	1/16W	5%	RMC1/16 103JATP	J24185103		1-	A	H1
R 3029	CHIP RES.	47	1/16W	5%	RMC1/16 470JATP	J24185470		1-	A	A3
R 3030	CHIP RES.	10	1/16W	5%	RMC1/16 100JATP	J24185100		1-	A	A3
R 3031	CHIP RES.	47	1/16W	5%	RMC1/16 470JATP	J24185470		1-	A	A3
R 3032	CHIP RES.	47	1/16W	5%	RMC1/16 470JATP	J24185470		1-	A	A3
R 3033	CHIP RES.	47	1/16W	5%	RMC1/16 470JATP	J24185470		1-	A	A3
R 3034	CHIP RES.	47	1/16W	5%	RMC1/16 470JATP	J24185470		1-	A	A3
R 3035	CHIP RES.	4.7k	1/16W	5%	RMC1/16 472JATP	J24185472		1-	A	H1
R 3037	CHIP RES.	4.7k	1/16W	5%	RMC1/16 472JATP	J24185472		1-	A	H1
R 3039	CHIP RES.	4.7k	1/16W	5%	RMC1/16 472JATP	J24185472		1-	A	F2
R 3041	CHIP RES.	4.7k	1/16W	5%	RMC1/16 472JATP	J24185472		1-	A	E2
R 3042	CHIP RES.	4.7k	1/16W	5%	RMC1/16 472JATP	J24185472		1-	A	E2
R 3043	CHIP RES.	4.7k	1/16W	5%	RMC1/16 472JATP	J24185472		1-	A	D2
R 3044	CHIP RES.	4.7k	1/16W	5%	RMC1/16 472JATP	J24185472		1-	A	D2
R 3045	CHIP RES.	4.7k	1/16W	5%	RMC1/16 472JATP	J24185472		1-	A	D2
R 3046	CHIP RES.	4.7k	1/16W	5%	RMC1/16 472JATP	J24185472		1-	A	D2
R 3049	CHIP RES.	15k	1/16W	5%	RMC1/16 153JATP	J24185153		1-	A	C2
R 3050	CHIP RES.	4.7k	1/16W	5%	RMC1/16 472JATP	J24185472		1-	A	C2
R 3051	CHIP RES.	10k	1/16W	5%	RMC1/16 103JATP	J24185103		1-	A	C2
R 3052	CHIP RES.	10k	1/16W	5%	RMC1/16 103JATP	J24185103		1-	A	C2
R 3053	CHIP RES.	47k	1/16W	5%	RMC1/16 473JATP	J24185473		1-	A	C2
R 3054	CHIP RES.	47k	1/16W	5%	RMC1/16 473JATP	J24185473		1-	A	C2
R 3055	CHIP RES.	3.9	1W	5%	RMC1 3R9JTE	J24305399		1-	A	B1
R 3056	CHIP RES.	3.9	1W	5%	RMC1 3R9JTE	J24305399		1-	A	B1
R 3057	CHIP RES.	3.9	1W	5%	RMC1 3R9JTE	J24305399		1-	A	B1
R 3058	CHIP RES.	3.9	1W	5%	RMC1 3R9JTE	J24305399		1-	A	B1
R 3059	CHIP RES.	47k	1/16W	5%	RMC1/16 473JATP	J24185473		1-	A	H1
R 3060	CHIP RES.	15k	1/16W	5%	RMC1/16 153JATP	J24185153		1-	A	H1
R 3061	CHIP RES.	15k	1/16W	5%	RMC1/16 153JATP	J24185153		1-	A	H1
R 3062	CHIP RES.	15k	1/16W	5%	RMC1/16 153JATP	J24185153		1-	A	H1
R 3063	CHIP RES.	15k	1/16W	5%	RMC1/16 153JATP	J24185153		1-	A	H1
R 3064	CHIP RES.	4.7k	1/16W	5%	RMC1/16 472JATP	J24185472		1-	A	H1
R 3065	CHIP RES.	47k	1/16W	5%	RMC1/16 473JATP	J24185473		1-	A	G1
R 3066	CHIP RES.	47k	1/16W	5%	RMC1/16 473JATP	J24185473		1-	A	G1
R 3067	CHIP RES.	0	1/16W	5%	RMC1/16 000JATP	J24185000		1-	A	H2
R 3068	CHIP RES.	100k	1/16W	5%	RMC1/16 104JATP	J24185104		1-	A	C2
R 3069	CHIP RES.	100k	1/16W	5%	RMC1/16 104JATP	J24185104		1-	A	C2
R 3070	CHIP RES.	330k	1/16W	5%	RMC1/16 334JATP	J24185334		1-	A	C2
R 3071	CHIP RES.	100k	1/16W	5%	RMC1/16 104JATP	J24185104		1-	A	C2
R 3072	CHIP RES.	47k	1/16W	5%	RMC1/16 473JATP	J24185473		1-	A	C2
R 3073	CHIP RES.	10k	1/16W	5%	RMC1/16 103JATP	J24185103		1-	A	C2
R 3074	CHIP RES.	4.7k	1/16W	5%	RMC1/16 472JATP	J24185472		1-	A	C2
R 3075	CHIP RES.	47k	1/16W	5%	RMC1/16 473JATP	J24185473		1-	A	C2
R 3076	CHIP RES.	10k	1/16W	5%	RMC1/16 103JATP	J24185103		1-	A	D2
R 3077	CHIP RES.	10k	1/16W	5%	RMC1/16 103JATP	J24185103		1-	A	F1
R 3078	CHIP RES.	1k	1/16W	5%	RMC1/16 102JATP	J24185102		1-	A	F1
R 3079	CHIP RES.	22k	1/16W	5%	RMC1/16 223JATP	J24185223		1-	A	H1
R 3080	CHIP RES.	22k	1/16W	5%	RMC1/16 223JATP	J24185223		1-	A	H1
R 3081	CHIP RES.	22k	1/16W	5%	RMC1/16 223JATP	J24185223		1-	A	H1
R 3082	CHIP RES.	1M	1/16W	5%	RMC1/16 105JATP	J24185105		1-	A	F2
R 3083	CHIP RES.	1M	1/16W	5%	RMC1/16 105JATP	J24185105		1-	A	F2
R 3084	CHIP RES.	1M	1/16W	5%	RMC1/16 105JATP	J24185105		1-	A	F3
R 3085	CHIP RES.	1M	1/16W	5%	RMC1/16 105JATP	J24185105		1-	A	F3
R 3086	CHIP RES.	1M	1/16W	5%	RMC1/16 105JATP	J24185105		1-	A	F2
R 3087	CHIP RES.	1M	1/16W	5%	RMC1/16 105JATP	J24185105		1-	A	F2
R 3088	CHIP RES.	1M	1/16W	5%	RMC1/16 105JATP	J24185105		1-	A	F2
R 3089	CHIP RES.	1M	1/16W	5%	RMC1/16 105JATP	J24185105		1-	A	F3
R 3090	CHIP RES.	100k	1/16W	5%	RMC1/16 104JATP	J24185104		1-	A	G3
R 3091	CHIP RES.	100k	1/16W	5%	RMC1/16 104JATP	J24185104		1-	A	D3
R 3092	CHIP RES.	0	1/16W	5%	RMC1/16 000JATP	J24185000		1-	A	G3
R 3093	CHIP RES.	1	1/10W	5%	RMC1/10T 1R0J	J24205010		1-	A	D1
R 3094	CHIP RES.	1	1/10W	5%	RMC1/10T 1R0J	J24205010		1-	A	D1
R 3095	CHIP RES.	1	1/10W	5%	RMC1/10T 1R0J	J24205010		1-	A	D1
R 3096	CHIP RES.	1	1/10W	5%	RMC1/10T 1R0J	J24205010		1-	A	D1
R 3097	CHIP RES.	6.2k	1/16W	1%	RMC1/16 622FTP	J24183622		1-	A	D1
R 3098	CHIP RES.	0	1/16W	5%	RMC1/16 000JATP	J24185000		1-3	A	G4
R 3100	CHIP RES.	22k	1/16W	5%	RMC1/16 223JATP	J24185223		1-	A	E3
R 3101	CHIP RES.	22k	1/16W	5%	RMC1/16 223JATP	J24185223		1-	A	E3
R 3102	CHIP RES.	22k	1/16W	5%	RMC1/16 223JATP	J24185223		1-	A	E2
R 3103	CHIP RES.	47k	1/16W	5%	RMC1/16 473JATP	J24185473		1-	A	B3
R 3104	CHIP RES.	1k	1/16W	1%	RMC1/16 102FTP	J24183102		1-	A	E1
R 3105	CHIP RES.	47k	1/16W	5%	RMC1/16 473JATP	J24185473		1-	A	F3
R 3106	CHIP RES.	47k	1/16W	5%	RMC1/16 473JATP	J24185473		1-	A	F3

CNTL Unit

Parts List

REF	DESCRIPTION	VALUE	V/W	TOL.	MFR'S DESIG	VXSTD P/N	VERS.	LOT	SIDE	LAY ADR
R 3107	CHIP RES.	47k	1/16W	5%	RMC1/16 473JATP	J24185473		1-	A	F3
R 3108	CHIP RES.	4.7k	1/16W	5%	RMC1/16 472JATP	J24185472		1-	A	F3
R 3109	CHIP RES.	4.7k	1/16W	5%	RMC1/16 472JATP	J24185472		1-	A	F3
R 3110	CHIP RES.	47k	1/16W	5%	RMC1/16 473JATP	J24185473		1-	A	F3
R 3111	CHIP RES.	47k	1/16W	5%	RMC1/16 473JATP	J24185473		1-	A	F3
R 3112	CHIP RES.	47k	1/16W	5%	RMC1/16 473JATP	J24185473		1-	A	F3
R 3113	CHIP RES.	47k	1/16W	5%	RMC1/16 473JATP	J24185473		1-	A	F3
R 3114	CHIP RES.	47k	1/16W	5%	RMC1/16 473JATP	J24185473		1-	A	F3
R 3115	CHIP RES.	4.7k	1/16W	5%	RMC1/16 472JATP	J24185472		1-	A	F2
R 3116	CHIP RES.	10k	1/16W	5%	RMC1/16 103JATP	J24185103		1-	A	F3
R 3120	CHIP RES.	47k	1/16W	5%	RMC1/16 473JATP	J24185473		1-	A	F3
R 3121	CHIP RES.	4.7k	1/16W	5%	RMC1/16 472JATP	J24185472		1-	A	F4
R 3122	CHIP RES.	4.7k	1/16W	5%	RMC1/16 472JATP	J24185472		1-	A	F4
R 3123	CHIP RES.	4.7k	1/16W	5%	RMC1/16 472JATP	J24185472		1-	A	F3
R 3124	CHIP RES.	4.7k	1/16W	5%	RMC1/16 472JATP	J24185472		1-	A	F3
R 3126	CHIP RES.	3.3k	1/16W	5%	RMC1/16 332JATP	J24185332		1-	A	E3
R 3127	CHIP RES.	100	1/16W	5%	RMC1/16 101JATP	J24185101		1-	A	F2
R 3128	CHIP RES.	10k	1/16W	5%	RMC1/16 103JATP	J24185103		1-	A	F2
R 3129	CHIP RES.	10k	1/16W	5%	RMC1/16 103JATP	J24185103		1-	A	F3
R 3130	CHIP RES.	10k	1/16W	5%	RMC1/16 103JATP	J24185103		1-	A	F3
R 3131	CHIP RES.	10k	1/16W	5%	RMC1/16 103JATP	J24185103		1-	A	F2
R 3132	CHIP RES.	10k	1/16W	5%	RMC1/16 103JATP	J24185103		1-	A	F2
R 3133	CHIP RES.	4.7k	1/16W	5%	RMC1/16 472JATP	J24185472		1-	A	A3
R 3134	CHIP RES.	4.7k	1/16W	5%	RMC1/16 472JATP	J24185472		1-	A	A3
R 3135	CHIP RES.	2.2M	1/16W	5%	RMC1/16 225JATP	J24185225		1-3	A	E3
R 3136	CHIP RES.	3.9k	1/16W	5%	RMC1/16 392JATP	J24185392		1-	A	E3
R 3137	CHIP RES.	3.9k	1/16W	5%	RMC1/16 392JATP	J24185392		1-	A	E3
R 3138	CHIP RES.	3.9k	1/16W	5%	RMC1/16 392JATP	J24185392		1-	A	D3
R 3139	CHIP RES.	4.7k	1/16W	5%	RMC1/16 472JATP	J24185472		1-	A	G2
R 3140	CHIP RES.	0	1/16W	5%	RMC1/16 000JATP	J24185000		1-	A	F2
R 3141	CHIP RES.	10k	1/16W	5%	RMC1/16 103JATP	J24185103		1-	A	G3
R 3142	CHIP RES.	10k	1/16W	5%	RMC1/16 103JATP	J24185103		1-	A	G3
R 3143	CHIP RES.	10k	1/16W	5%	RMC1/16 103JATP	J24185103		1-	A	F3
R 3144	CHIP RES.	4.7k	1/16W	5%	RMC1/16 472JATP	J24185472		1-	A	F4
R 3145	CHIP RES.	100	1/16W	5%	RMC1/16 101JATP	J24185101		1-	A	B3
R 3146	CHIP RES.	100	1/16W	5%	RMC1/16 101JATP	J24185101		1-	A	B3
R 3147	CHIP RES.	47k	1/16W	5%	RMC1/16 473JATP	J24185473		1-	A	F4
R 3148	CHIP RES.	47k	1/16W	5%	RMC1/16 473JATP	J24185473		1-	A	F4
R 3149	CHIP RES.	100	1/16W	5%	RMC1/16 101JATP	J24185101		1-	A	B3
R 3150	CHIP RES.	100	1/16W	5%	RMC1/16 101JATP	J24185101		1-	A	C3
R 3151	CHIP RES.	100	1/16W	5%	RMC1/16 101JATP	J24185101		1-	A	C3
R 3152	CHIP RES.	100	1/16W	5%	RMC1/16 101JATP	J24185101		1-	A	C3
R 3153	CHIP RES.	100	1/16W	5%	RMC1/16 101JATP	J24185101		1-	A	C3
R 3154	CHIP RES.	100	1/16W	5%	RMC1/16 101JATP	J24185101		1-	A	C3
R 3155	CHIP RES.	100	1/16W	5%	RMC1/16 101JATP	J24185101		1-	A	C3
R 3156	CHIP RES.	3.9k	1/16W	5%	RMC1/16 392JATP	J24185392		1-	A	D4
R 3157	CHIP RES.	10k	1/16W	5%	RMC1/16 103JATP	J24185103		1-	A	D4
R 3158	CHIP RES.	10	1/16W	5%	RMC1/16 100JATP	J24185100		1-	A	G2
R 3159	CHIP RES.	4.7k	1/16W	5%	RMC1/16 472JATP	J24185472		1-	A	G2
R 3160	CHIP RES.	4.7k	1/16W	5%	RMC1/16 472JATP	J24185472		1-	A	G2
R 3161	CHIP RES.	0	1/16W	5%	RMC1/16 000JATP	J24185000		1-	A	G2
R 3162	CHIP RES.	3.3k	1/16W	5%	RMC1/16 332JATP	J24185332		1-	A	G3
R 3163	CHIP RES.	100	1/16W	5%	RMC1/16 101JATP	J24185101		1-	A	B3
R 3165	CHIP RES.	47k	1/16W	5%	RMC1/16 473JATP	J24185473		1-	A	F3
R 3166	CHIP RES.	4.7k	1/16W	5%	RMC1/16 472JATP	J24185472		1-	A	F3
R 3169	CHIP RES.	47k	1/16W	5%	RMC1/16 473JATP	J24185473		1-	A	F4
R 3170	CHIP RES.	100	1/16W	5%	RMC1/16 101JATP	J24185101		1-	A	B3
R 3171	CHIP RES.	100	1/16W	5%	RMC1/16 101JATP	J24185101		1-	A	B2
R 3172	CHIP RES.	100	1/16W	5%	RMC1/16 101JATP	J24185101		1-	A	C2
R 3173	CHIP RES.	100	1/16W	5%	RMC1/16 101JATP	J24185101		1-	A	C2
R 3174	CHIP RES.	100	1/16W	5%	RMC1/16 101JATP	J24185101		1-	A	C2
R 3175	CHIP RES.	100	1/16W	5%	RMC1/16 101JATP	J24185101		1-	A	C2
R 3176	CHIP RES.	100	1/16W	5%	RMC1/16 101JATP	J24185101		1-	A	C3
R 3177	CHIP RES.	100	1/16W	5%	RMC1/16 101JATP	J24185101		1-	A	C3
R 3178	CHIP RES.	100k	1/16W	5%	RMC1/16 104JATP	J24185104		1-	A	G3
R 3179	CHIP RES.	10k	1/16W	5%	RMC1/16 103JATP	J24185103		1-	A	F3
R 3180	CHIP RES.	4.7k	1/16W	5%	RMC1/16 472JATP	J24185472		1-	A	F4
R 3182	CHIP RES.	100k	1/16W	5%	RMC1/16 104JATP	J24185104		1-	A	F3
R 3185	CHIP RES.	4.7k	1/16W	5%	RMC1/16 472JATP	J24185472		1-	A	F3
R 3188	CHIP RES.	47k	1/16W	5%	RMC1/16 473JATP	J24185473		1-	A	F4
R 3189	CHIP RES.	47k	1/16W	5%	RMC1/16 473JATP	J24185473		1-	A	E3
R 3190	CHIP RES.	47k	1/16W	5%	RMC1/16 473JATP	J24185473		1-	A	E3
R 3191	CHIP RES.	1k	1/16W	5%	RMC1/16 102JATP	J24185102		1-	A	D2

CNTL Unit

Parts List

REF	DESCRIPTION	VALUE	V/W	TOL.	MFR'S DESIG	VXSTD P/N	VERS.	LOT	SIDE	LAY ADR
R 3192	CHIP RES.	1k	1/16W	5%	RMC1/16 102JATP	J24185102		1-	A	D2
R 3193	CHIP RES.	1k	1/16W	5%	RMC1/16 102JATP	J24185102		1-	A	D3
R 3194	CHIP RES.	47k	1/16W	5%	RMC1/16 473JATP	J24185473		1-	A	E2
R 3195	CHIP RES.	100k	1/16W	5%	RMC1/16 104JATP	J24185104		1-	A	F3
R 3196	CHIP RES.	100k	1/16W	5%	RMC1/16 104JATP	J24185104		1-	A	F3
R 3197	CHIP RES.	100k	1/16W	5%	RMC1/16 104JATP	J24185104		1-	A	G3
R 3198	CHIP RES.	100k	1/16W	5%	RMC1/16 104JATP	J24185104		1-	A	G3
R 3199	CHIP RES.	100k	1/16W	5%	RMC1/16 104JATP	J24185104		1-	A	G3
R 3200	CHIP RES.	100k	1/16W	5%	RMC1/16 104JATP	J24185104		1-	A	G3
R 3201	CHIP RES.	100k	1/16W	5%	RMC1/16 104JATP	J24185104		1-	A	F3
R 3202	CHIP RES.	100k	1/16W	5%	RMC1/16 104JATP	J24185104		1-	A	F2
R 3203	CHIP RES.	0	1/16W	5%	RMC1/16 000JATP	J24185000		1-	A	I3
R 3204	CHIP RES.	0	1/16W	5%	RMC1/16 000JATP	J24185000		1-	A	I3
R 3205	CHIP RES.	0	1/16W	5%	RMC1/16 000JATP	J24185000		1-	A	I3
R 3206	CHIP RES.	0	1/16W	5%	RMC1/16 000JATP	J24185000		1-	A	I3
R 3207	CHIP RES.	0	1/16W	5%	RMC1/16 000JATP	J24185000		1-	A	I3
R 3208	CHIP RES.	0	1/16W	5%	RMC1/16 000JATP	J24185000		1-	A	C4
R 3209	CHIP RES.	4.7k	1/10W	0.5%	RR1220P-472-D-T5	J24209187		1-	A	C3
R 3210	CHIP RES.	0	1/16W	5%	RMC1/16 000JATP	J24185000		1-	A	C4
R 3211	CHIP RES.	470	1/16W	5%	RMC1/16 471JATP	J24185471		1-	A	I1
R 3212	CHIP RES.	470	1/16W	5%	RMC1/16 471JATP	J24185471		1-	A	I1
R 3213	CHIP RES.	470	1/16W	5%	RMC1/16 471JATP	J24185471		1-	A	I1
R 3215	CHIP RES.	2.2k	1/16W	5%	RMC1/16 222JATP	J24185222		1-	A	E2
R 3216	CHIP RES.	2.2k	1/16W	5%	RMC1/16 222JATP	J24185222		1-	A	E2
R 3217	CHIP RES.	2.2k	1/16W	5%	RMC1/16 222JATP	J24185222		1-	A	D2
R 3218	CHIP RES.	2.2k	1/16W	5%	RMC1/16 222JATP	J24185222		1-	A	D2
R 3219	CHIP RES.	470	1/16W	5%	RMC1/16 471JATP	J24185471		1-	A	D2
R 3220	CHIP RES.	470	1/16W	5%	RMC1/16 471JATP	J24185471		1-	A	E2
R 3221	CHIP RES.	2.7k	1/16W	5%	RMC1/16 272JATP	J24185272		1-	A	D2
R 3222	CHIP RES.	2.7k	1/16W	5%	RMC1/16 272JATP	J24185272		1-	A	D2
R 3223	CHIP RES.	2.7k	1/16W	5%	RMC1/16 272JATP	J24185272		1-	A	D2
R 3224	CHIP RES.	2.7k	1/16W	5%	RMC1/16 272JATP	J24185272		1-	A	D2
R 3225	CHIP RES.	270	1/16W	5%	RMC1/16 271JATP	J24185271		1-	A	E2
R 3226	CHIP RES.	47k	1/16W	5%	RMC1/16 473JATP	J24185473		1-	A	E2
R 3227	CHIP RES.	4.7k	1/16W	5%	RMC1/16 472JATP	J24185472		1-	A	E2
R 3228	CHIP RES.	47k	1/16W	5%	RMC1/16 473JATP	J24185473		1-	A	E2
R 3229	CHIP RES.	270	1/16W	5%	RMC1/16 271JATP	J24185271		1-	A	E2
R 3230	CHIP RES.	100k	1/16W	5%	RMC1/16 104JATP	J24185104		1-	A	F4
R 3231	CHIP RES.	0	1/16W	5%	RMC1/16 000JATP	J24185000		1-	A	C3
R 3232	CHIP RES.	0	1/16W	5%	RMC1/16 000JATP	J24185000		1-	A	C3
R 3233	CHIP RES.	1k	1/16W	5%	RMC1/16 102JATP	J24185102		1-	A	D1
R 3234	CHIP RES.	1k	1/16W	5%	RMC1/16 102JATP	J24185102		1-	A	D1
R 3235	CHIP RES.	10	1W	5%	RMC1 100JTE	J24305100		1-	A	B2
R 3236	CHIP RES.	10	1W	5%	RMC1 100JTE	J24305100		1-	A	B2
R 3237	CHIP RES.	0	1W	5%	RMC1 JPATE	J24305000		1-	A	H1
R 3238	CHIP RES.	0	1/16W	5%	RMC1/16 000JATP	J24185000		1-	A	G1
R 3239	CARBON FILM RES.	47k	1/6W	5%	RD16PJ473 47K	J01225473		1-		
R 3239	CHIP RES.	47k	1/16W	5%	RMC1/16 473JATP	J24185473		3-		
R 3240	CHIP RES.	0	1/16W	5%	RMC1/16 000JATP	J24185000		3-		
R 3242	CHIP RES.	100k	1/16W	5%	RMC1/16 104JATP	J24185104		3-		
R 3243	CHIP RES.	0	1/16W	5%	RMC1/16 000JATP	J24185000		3-		
R 3244	CHIP RES.	10k	1/16W	5%	RMC1/16S 103JTH	J24189037		1-7		
RB3001	BLOCK RES.				RAC104D103JCTP	J42900024		1-	A	F2
RB3002	BLOCK RES.				RAC104D103JCTP	J42900024		1-	A	F3
RB3002	BLOCK RES.				RAC104D332JCTH	J42900041		8-	A	F3
RB3003	BLOCK RES.				RAC104D103JCTP	J42900024		1-	A	F3
RB3003	BLOCK RES.				RAC104D332JCTH	J42900041		8-	A	F3
RB3004	BLOCK RES.				RAC104D103JCTP	J42900024		1-	A	F3
RB3005	BLOCK RES.				RAC104D103JCTP	J42900024		1-	A	F3
RB3006	BLOCK RES.				RAC104D103JCTP	J42900024		1-	A	F2
RB3007	BLOCK RES.				RAC104D103JCTP	J42900024		1-	A	F3
RB3008	BLOCK RES.				RAC104D103JCTP	J42900024		1-	A	F3
RB3009	BLOCK RES.				RAC104D103JCTP	J42900024		1-	A	F3
RB3010	BLOCK RES.				RAC104D103JCTP	J42900024		1-	A	F3
RB3011	BLOCK RES.				RAC104D103JCTP	J42900024		1-	A	G3
RB3012	BLOCK RES.				RAC104D103JCTP	J42900024		1-	A	F3
S 3001	SLIDE SWITCH				SSSS820201	N6090107		1-	A	F1
S 3003	TACT SWITCH				SKRPABE010	N5090133		1-2	A	G2
S 3004	SLIDE SWITCH				SSSS820201	N6090107		1-	A	C2
X 3001	XTAL SMD-49	11.1MHZ			11.10MHZ	H0103321		1-	A	F2

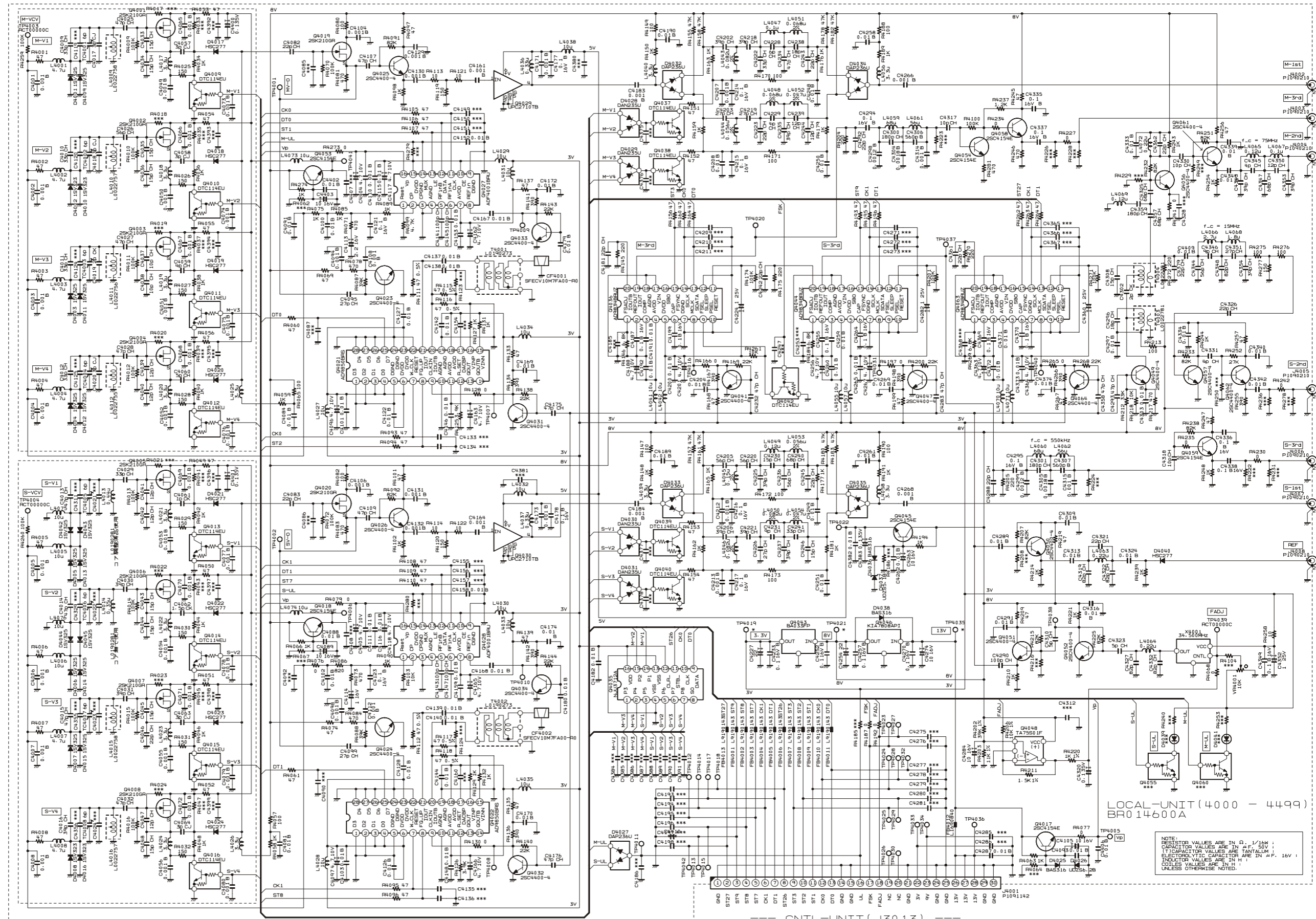

LOCAL Unit

Note

LOCAL Unit

Parts Layout (Side A)

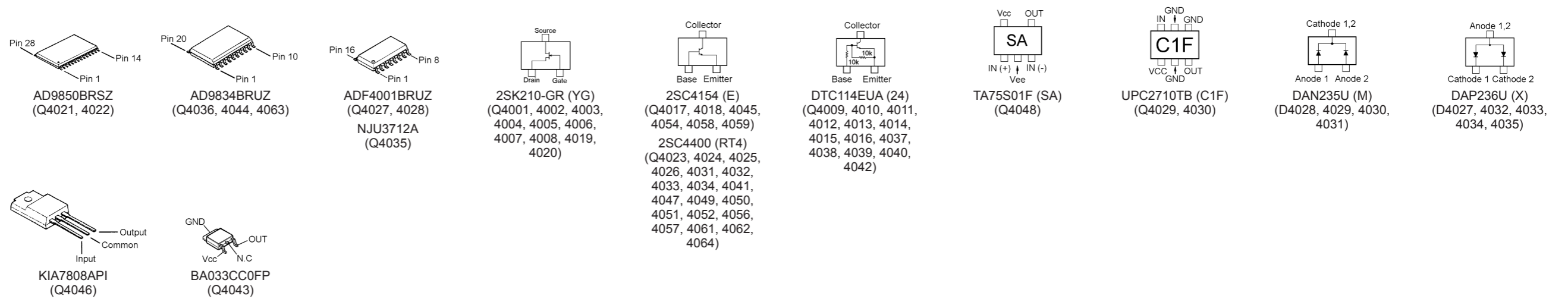
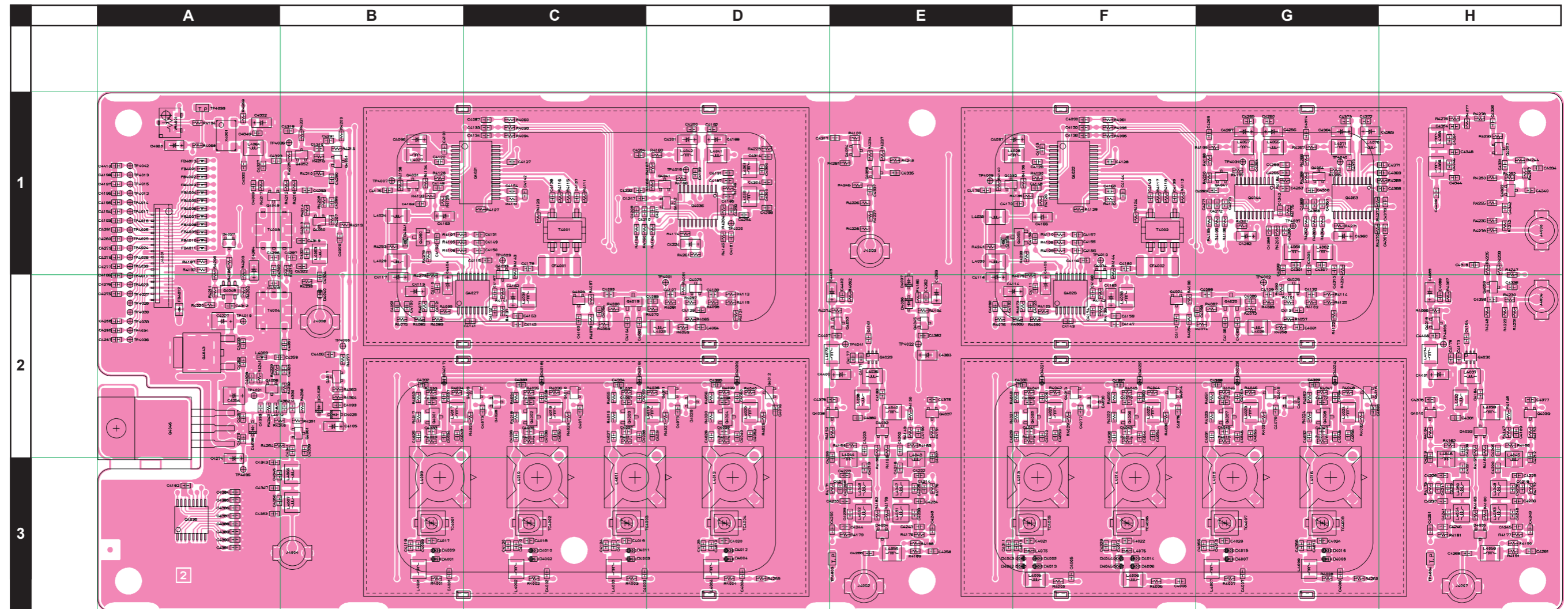

LOCAL Unit

Parts Layout (Side B)

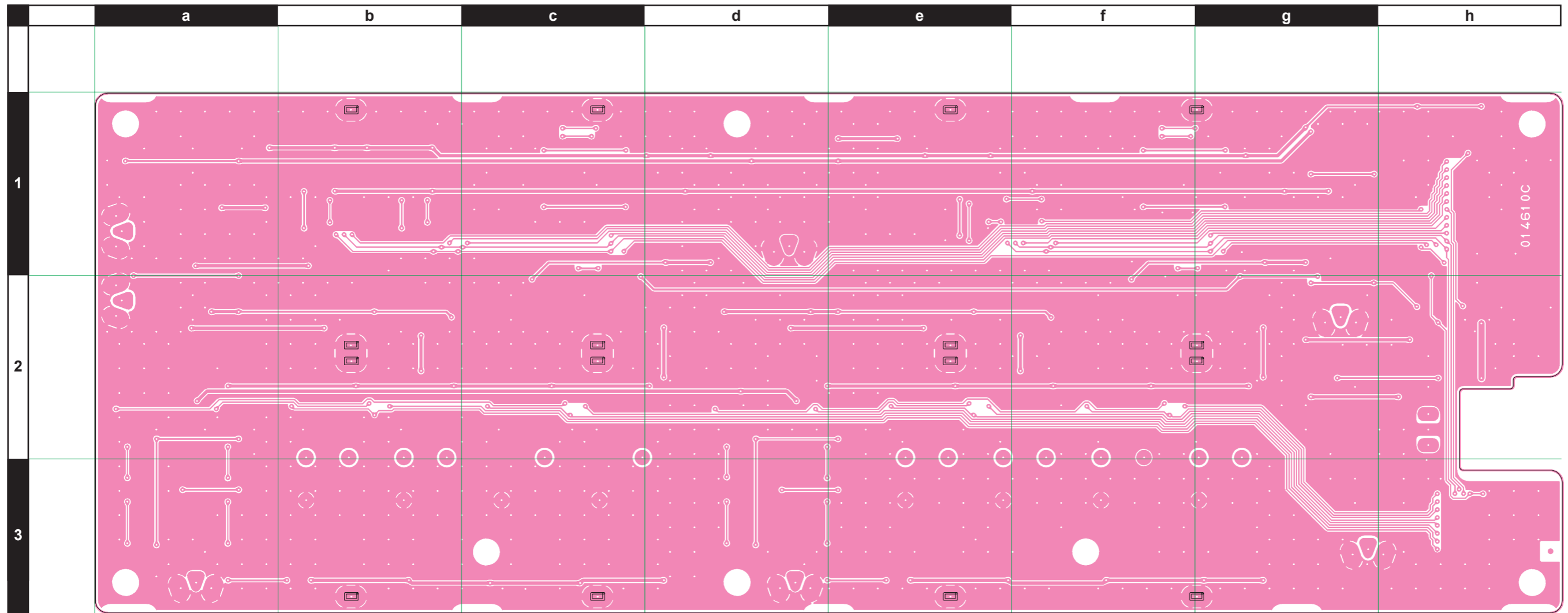

LOCAL Unit

Parts List

REF	DESCRIPTION	VALUE	V/W	TOL.	MFR'S DESIG	VXSTD P/N	VERS.	LOT	SIDE	LAY ADR
PCB with Components						CB3485001				
	Printed Circuit Board				AH025H000	FR014610C		1-		
C 4001	CHIP CAP.	0.001uF	50V	B	GRM188B11H102KA01D	K22174821		1-	A	B3
C 4002	CHIP CAP.	0.001uF	50V	B	GRM188B11H102KA01D	K22174821		1-	A	C3
C 4003	CHIP CAP.	0.001uF	50V	B	GRM188B11H102KA01D	K22174821		1-	A	C3
C 4004	CHIP CAP.	0.001uF	50V	B	GRM188B11H102KA01D	K22174821		1-	A	D3
C 4005	CHIP CAP.	0.001uF	50V	B	GRM188B11H102KA01D	K22174821		1-	A	F3
C 4006	CHIP CAP.	0.001uF	50V	B	GRM188B11H102KA01D	K22174821		1-	A	F3
C 4007	CHIP CAP.	0.001uF	50V	B	GRM188B11H102KA01D	K22174821		1-	A	G3
C 4008	CHIP CAP.	0.001uF	50V	B	GRM188B11H102KA01D	K22174821		1-	A	G3
C 4009	CHIP CAP.	33pF	50V	CH	GRM1882C1H330JA01D	K22174223		1-	A	B3
C 4010	CHIP CAP.	33pF	50V	CH	GRM1882C1H330JA01D	K22174223		1-	A	C3
C 4010	CHIP CAP.	30pF	50V	CH	GRM1882C1H300JZ01D	K22174222		3	A	C3
C 4010	CHIP CAP.	27pF	50V	CH	GRM1882C1H270JA01D	K22174221		4-	A	C3
C 4011	CHIP CAP.	33pF	50V	CH	GRM1882C1H330JA01D	K22174223		1-	A	C3
C 4011	CHIP CAP.	27pF	50V	CH	GRM1882C1H270JA01D	K22174221		4-	A	C3
C 4012	CHIP CAP.	33pF	50V	CH	GRM1882C1H330JA01D	K22174223		1-	A	D3
C 4012	CHIP CAP.	27pF	50V	CH	GRM1882C1H270JA01D	K22174221		4-	A	D3
C 4013	CHIP CAP.	47pF	50V	CH	GRM1882C1H470JA01D	K22174227		1-	A	F3
C 4014	CHIP CAP.	47pF	50V	CH	GRM1882C1H470JA01D	K22174227		1-	A	F3
C 4015	CHIP CAP.	47pF	50V	CH	GRM1882C1H470JA01D	K22174227		1-	A	G3
C 4016	CHIP CAP.	39pF	50V	CH	GRM1882C1H390JA01D	K22174225		1-	A	G3
C 4017	CHIP CAP.	3pF	50V	CJ	GRM1883C1H3R0CZ01D	K22174204		1-	A	B3
C 4018	CHIP CAP.	3pF	50V	CJ	GRM1883C1H3R0CZ01D	K22174204		1-	A	C3
C 4019	CHIP CAP.	2pF	50V	CK	GRM1884C1H2R0CZ01D	K22174203		1-	A	C3
C 4020	CHIP CAP.	3pF	50V	CJ	GRM1883C1H3R0CZ01D	K22174204		1-	A	D3
C 4025	CHIP CAP.	47pF	50V	CH	GRM1882C1H470JA01D	K22174227		1-	A	B2
C 4026	CHIP CAP.	56pF	50V	CH	GRM1882C1H560JA01D	K22174229		1-	A	C2
C 4027	CHIP CAP.	47pF	50V	CH	GRM1882C1H470JA01D	K22174227		1-	A	C2
C 4028	CHIP CAP.	47pF	50V	CH	GRM1882C1H470JA01D	K22174227		1-	A	D2
C 4029	CHIP CAP.	33pF	50V	CH	GRM1882C1H330JA01D	K22174223		1-	A	F2
C 4029	CHIP CAP.	39pF	50V	CH	GRM1882C1H390JA01D	K22174225		4-	A	F2
C 4030	CHIP CAP.	39pF	50V	CH	GRM1882C1H390JA01D	K22174225		1-	A	F2
C 4031	CHIP CAP.	39pF	50V	CH	GRM1882C1H390JA01D	K22174225		1-	A	G2
C 4031	CHIP CAP.	47pF	50V	CH	GRM1882C1H470JA01D	K22174227		3-	A	G2
C 4032	CHIP CAP.	47pF	50V	CH	GRM1882C1H470JA01D	K22174227		1-	A	G2
C 4033	CHIP CAP.	15pF	50V	CH	GRM1882C1H150JA01D	K22174215		1-	A	B2
C 4033	CHIP CAP.	12pF	50V	CH	GRM1882C1H120JA01D	K22174213		4-	A	B2
C 4034	CHIP CAP.	15pF	50V	CH	GRM1882C1H150JA01D	K22174215		1-	A	B2
C 4034	CHIP CAP.	22pF	50V	CH	GRM1882C1H220JA01D	K22174219		4-	A	B2
C 4035	CHIP CAP.	15pF	50V	CH	GRM1882C1H150JA01D	K22174215		1-	A	C2
C 4035	CHIP CAP.	12pF	50V	CH	GRM1882C1H120JA01D	K22174213		3-	A	C2
C 4036	CHIP CAP.	15pF	50V	CH	GRM1882C1H150JA01D	K22174215		1-	A	C2
C 4036	CHIP CAP.	22pF	50V	CH	GRM1882C1H220JA01D	K22174219		3-	A	C2
C 4037	CHIP CAP.	10pF	50V	CH	GRM1882C1H100JA01D	K22174211		1-	A	C2
C 4038	CHIP CAP.	10pF	50V	CH	GRM1882C1H100JA01D	K22174211		1-	A	C2
C 4038	CHIP CAP.	12pF	50V	CH	GRM1882C1H120JA01D	K22174213		4-	A	C2
C 4039	CHIP CAP.	12pF	50V	CH	GRM1882C1H120JA01D	K22174213		1-	A	D2
C 4040	CHIP CAP.	12pF	50V	CH	GRM1882C1H120JA01D	K22174213		1-	A	D2
C 4040	CHIP CAP.	22pF	50V	CH	GRM1882C1H220JA01D	K22174219		4-	A	D2
C 4041	CHIP CAP.	10pF	50V	CH	GRM1882C1H100JA01D	K22174211		1-	A	F2
C 4041	CHIP CAP.	8pF	50V	CH	GRM1882C1H8R0DZ01D	K22174209		4-	A	F2
C 4042	CHIP CAP.	15pF	50V	CH	GRM1882C1H150JA01D	K22174215		1-	A	F2
C 4042	CHIP CAP.	18pF	50V	CH	GRM1882C1H180JA01D	K22174217		4-	A	F2
C 4043	CHIP CAP.	15pF	50V	CH	GRM1882C1H150JA01D	K22174215		1-	A	F2
C 4043	CHIP CAP.	12pF	50V	CH	GRM1882C1H120JA01D	K22174213		3-	A	F2
C 4044	CHIP CAP.	15pF	50V	CH	GRM1882C1H150JA01D	K22174215		1-	A	F2
C 4044	CHIP CAP.	18pF	50V	CH	GRM1882C1H180JA01D	K22174217		3-	A	F2
C 4045	CHIP CAP.	15pF	50V	CH	GRM1882C1H150JA01D	K22174215		1-	A	G2
C 4045	CHIP CAP.	12pF	50V	CH	GRM1882C1H120JA01D	K22174213		3-	A	G2
C 4046	CHIP CAP.	22pF	50V	CH	GRM1882C1H220JA01D	K22174219		1-	A	G2
C 4046	CHIP CAP.	27pF	50V	CH	GRM1882C1H270JA01D	K22174221		3-	A	G2
C 4047	CHIP CAP.	12pF	50V	CH	GRM1882C1H120JA01D	K22174213		1-	A	G2
C 4047	CHIP CAP.	9pF	50V	CH	GRM1882C1H9R0DZ01D	K22174210		3-	A	G2
C 4048	CHIP CAP.	15pF	50V	CH	GRM1882C1H150JA01D	K22174215		1-	A	G2
C 4048	CHIP CAP.	22pF	50V	CH	GRM1882C1H220JA01D	K22174219		3-	A	G2
C 4049	CHIP CAP.	0.001uF	50V	B	GRM188B11H102KA01D	K22174821		1-	A	B2
C 4050	CHIP CAP.	0.001uF	50V	B	GRM188B11H102KA01D	K22174821		1-	A	C2
C 4051	CHIP CAP.	0.001uF	50V	B	GRM188B11H102KA01D	K22174821		1-	A	D2
C 4052	CHIP CAP.	0.001uF	50V	B	GRM188B11H102KA01D	K22174821		1-	A	D2
C 4053	CHIP CAP.	0.001uF	50V	B	GRM188B11H102KA01D	K22174821		1-	A	F2
C 4054	CHIP CAP.	0.001uF	50V	B	GRM188B11H102KA01D	K22174821		1-	A	F2
C 4055	CHIP CAP.	0.001uF	50V	B	GRM188B11H102KA01D	K22174821		1-	A	G2

LOCAL Unit

Parts List

REF	DESCRIPTION	VALUE	V/W	TOL.	MFR'S DESIG	VXSTD P/N	VERS.	LOT	SIDE	LAY ADR
C 4056	CHIP CAP.	0.001uF	50V	B	GRM188B11H102KA01D	K22174821		1-	A	G2
C 4057	CHIP CAP.	3pF	50V	CJ	GRM1883C1H3R0CZ01D	K22174204		1-	A	B2
C 4058	CHIP CAP.	3pF	50V	CJ	GRM1883C1H3R0CZ01D	K22174204		1-	A	C2
C 4058	CHIP CAP.	4pF	50V	CH	GRM1882C1H4R0CZ01D	K22174205		3	A	C2
C 4058	CHIP CAP.	3pF	50V	CJ	GRM1883C1H3R0CZ01D	K22174204		4-	A	C2
C 4059	CHIP CAP.	4pF	50V	CH	GRM1882C1H4R0CZ01D	K22174205		1-	A	C2
C 4060	CHIP CAP.	5pF	50V	CH	GRM1882C1H5R0CZ01D	K22174206		1-	A	D2
C 4061	CHIP CAP.	1.5pF	50V	CK	GRM1884C1H1R5CZ01D	K22174258		1-	A	F2
C 4061	CHIP CAP.	2pF	50V	CK	GRM1884C1H2R0CZ01D	K22174203		4-	A	F2
C 4062	CHIP CAP.	1.5pF	50V	CK	GRM1884C1H1R5CZ01D	K22174258		1-	A	F2
C 4062	CHIP CAP.	2pF	50V	CK	GRM1884C1H2R0CZ01D	K22174203		3-	A	F2
C 4063	CHIP CAP.	3pF	50V	CJ	GRM1883C1H3R0CZ01D	K22174204		1-	A	G2
C 4063	CHIP CAP.	4pF	50V	CH	GRM1882C1H4R0CZ01D	K22174205		3-	A	G2
C 4064	CHIP CAP.	3pF	50V	CJ	GRM1883C1H3R0CZ01D	K22174204		1-	A	G2
C 4064	CHIP CAP.	5pF	50V	CH	GRM1882C1H5R0CZ01D	K22174206		3-	A	G2
C 4065	CHIP CAP.	0.001uF	50V	B	GRM188B11H102KA01D	K22174821		1-	A	B2
C 4066	CHIP CAP.	0.001uF	50V	B	GRM188B11H102KA01D	K22174821		1-	A	C2
C 4067	CHIP CAP.	0.001uF	50V	B	GRM188B11H102KA01D	K22174821		1-	A	C2
C 4068	CHIP CAP.	0.001uF	50V	B	GRM188B11H102KA01D	K22174821		1-	A	D2
C 4069	CHIP CAP.	0.001uF	50V	B	GRM188B11H102KA01D	K22174821		1-	A	F2
C 4070	CHIP CAP.	0.001uF	50V	B	GRM188B11H102KA01D	K22174821		1-	A	F2
C 4071	CHIP CAP.	0.001uF	50V	B	GRM188B11H102KA01D	K22174821		1-	A	G2
C 4072	CHIP CAP.	0.001uF	50V	B	GRM188B11H102KA01D	K22174821		1-	A	G2
C 4073	CHIP CAP.	0.001uF	50V	B	GRM188B11H102KA01D	K22174821		1-	A	C2
C 4074	CHIP CAP.	0.001uF	50V	B	GRM188B11H102KA01D	K22174821		1-	A	C2
C 4075	CHIP CAP.	0.001uF	50V	B	GRM188B11H102KA01D	K22174821		1-	A	D2
C 4076	CHIP CAP.	0.001uF	50V	B	GRM188B11H102KA01D	K22174821		1-	A	D2
C 4077	CHIP CAP.	0.001uF	50V	B	GRM188B11H102KA01D	K22174821		1-	A	F2
C 4078	CHIP CAP.	0.001uF	50V	B	GRM188B11H102KA01D	K22174821		1-	A	F2
C 4079	CHIP CAP.	0.001uF	50V	B	GRM188B11H102KA01D	K22174821		1-	A	G2
C 4080	CHIP CAP.	0.001uF	50V	B	GRM188B11H102KA01D	K22174821		1-	A	G2
C 4081	CHIP CAP.	0.01uF	50V	B	GRM188B11H103KA01D	K22174823		1-	A	G2
C 4082	CHIP CAP.	22pF	50V	CH	GRM1882C1H220JA01D	K22174219		1-	A	C2
C 4083	CHIP CAP.	22pF	50V	CH	GRM1882C1H220JA01D	K22174219		1-	A	G2
C 4084	CHIP CAP.	0.01uF	50V	B	GRM188B11H103KA01D	K22174823		1-	A	D2
C 4088	CHIP CAP.	0.01uF	50V	B	GRM188B11H103KA01D	K22174823		1-	A	H2
C 4089	CHIP TA.CAP.	10uF	16V		TEESVA1C106M8R	K78120077		1-	A	H2
C 4093	CHIP CAP.	0.01uF	50V	B	GRM188B11H103KA01D	K22174823		1-	A	B2
C 4094	CHIP CAP.	0.001uF	50V	B	GRM188B11H102KA01D	K22174821		1-	A	C2
C 4095	CHIP CAP.	27pF	50V	CH	GRM1882C1H270JA01D	K22174221		1-	A	C2
C 4096	CHIP TA.CAP.	4.7uF	10V		TEMSVA1A475M-8R	K78100022		1-	A	B1
C 4097	CHIP TA.CAP.	4.7uF	10V		TEMSVA1A475M-8R	K78100022		1-	A	F1
C 4098	CHIP CAP.	0.001uF	50V	B	GRM188B11H102KA01D	K22174821		1-	A	G2
C 4099	CHIP CAP.	27pF	50V	CH	GRM1882C1H270JA01D	K22174221		1-	A	G2
C 4101	CHIP CAP.	0.01uF	50V	B	GRM188B11H103KA01D	K22174823		1-	A	B1
C 4103	CHIP CAP.	0.01uF	50V	B	GRM188B11H103KA01D	K22174823		1-	A	F1
C 4104	CHIP CAP.	0.001uF	50V	B	GRM188B11H102KA01D	K22174821		1-	A	C2
C 4105	CHIP TA.CAP.	10uF	16V		TEESVA1C106M8R	K78120077		1-	A	B2
C 4106	CHIP CAP.	0.001uF	50V	B	GRM188B11H102KA01D	K22174821		1-	A	G2
C 4107	CHIP CAP.	47pF	50V	CH	GRM1882C1H470JA01D	K22174227		1-	A	D2
C 4108	CHIP CAP.	0.001uF	50V	B	GRM188B11H102KA01D	K22174821		1-	A	C2
C 4109	CHIP CAP.	47pF	50V	CH	GRM1882C1H470JA01D	K22174227		1-	A	G2
C 4110	CHIP CAP.	0.001uF	50V	B	GRM188B11H102KA01D	K22174821		1-	A	B2
C 4111	CHIP CAP.	0.01uF	50V	B	GRM188B11H103KA01D	K22174823		1-	A	F2
C 4112	CHIP CAP.	0.001uF	50V	B	GRM188B11H102KA01D	K22174821		1-	A	F2
C 4113	CHIP TA.CAP.	1uF	16V		TESVA1C105M1-8R	K78120009		1-	A	B2
C 4114	CHIP TA.CAP.	1uF	16V		TESVA1C105M1-8R	K78120009		1-	A	F2
C 4115	CHIP CAP.	0.01uF	50V	B	GRM188B11H103KA01D	K22174823		1-	A	C1
C 4116	CHIP CAP.	0.01uF	50V	B	GRM188B11H103KA01D	K22174823		1-	A	F1
C 4117	CHIP TA.CAP.	4.7uF	10V		TEMSVA1A475M-8R	K78100022		1-	A	B2
C 4118	CHIP TA.CAP.	4.7uF	10V		TEMSVA1A475M-8R	K78100022		1-	A	E2
C 4120	CHIP CAP.	4pF	50V	CH	GRM1882C1H4R0CZ01D	K22174205		4-	A	C3
C 4121	CHIP CAP.	0.1uF	16V	B	GRM188B11C104KA01D	K22124805		1-	A	B2
C 4122	CHIP CAP.	0.01uF	50V	B	GRM188B11H103KA01D	K22174823		1-	A	B1
C 4123	CHIP CAP.	0.1uF	16V	B	GRM188B11C104KA01D	K22124805		1-	A	F2
C 4124	CHIP CAP.	4pF	50V	CH	GRM1882C1H4R0CZ01D	K22174205		4-	A	C3
C 4125	CHIP CAP.	3pF	50V	CJ	GRM1883C1H3R0CZ01D	K22174204		4-	A	D3
C 4126	CHIP CAP.	0.01uF	50V	B	GRM188B11H103KA01D	K22174823		1-	A	F1
C 4127	CHIP CAP.	0.01uF	50V	B	GRM188B11H103KA01D	K22174823		1-	A	C1
C 4128	CHIP CAP.	0.01uF	50V	B	GRM188B11H103KA01D	K22174823		1-	A	F1
C 4129	CHIP CAP.	0.001uF	50V	B	GRM188B11H102KA01D	K22174821		1-	A	D2
C 4130	CHIP CAP.	0.001uF	50V	B	GRM188B11H102KA01D	K22174821		1-	A	D2
C 4131	CHIP CAP.	0.001uF	50V	B	GRM188B11H102KA01D	K22174821		1-	A	G2

LOCAL Unit

Parts List

REF	DESCRIPTION	VALUE	V/W	TOL.	MFR'S DESIG	VXSTD P/N	VERS.	LOT	SIDE	LAY ADR
C 4132	CHIP CAP.	0.001uF	50V	B	GRM188B11H102KA01D	K22174821		1-	A	G2
C 4137	CHIP CAP.	0.01uF	50V	B	GRM188B11H103KA01D	K22174823		1-	A	C1
C 4138	CHIP CAP.	0.01uF	50V	B	GRM188B11H103KA01D	K22174823		1-	A	C1
C 4139	CHIP CAP.	0.01uF	50V	B	GRM188B11H103KA01D	K22174823		1-	A	F1
C 4140	CHIP CAP.	0.01uF	50V	B	GRM188B11H103KA01D	K22174823		1-	A	F1
C 4141	CHIP CAP.	100pF	50V	CH	GRM1882C1H101JA01D	K22174235		1-	A	C2
C 4142	CHIP CAP.	0.01uF	50V	B	GRM188B11H103KA01D	K22174823		1-	A	C1
C 4143	CHIP CAP.	100pF	50V	CH	GRM1882C1H101JA01D	K22174235		1-	A	F2
C 4144	CHIP CAP.	0.01uF	50V	B	GRM188B11H103KA01D	K22174823		1-	A	F1
C 4145	CHIP CAP.	100pF	50V	CH	GRM1882C1H101JA01D	K22174235		1-	A	C2
C 4146	CHIP CAP.	0.01uF	50V	B	GRM188B11H103KA01D	K22174823		1-	A	B1
C 4147	CHIP CAP.	100pF	50V	CH	GRM1882C1H101JA01D	K22174235		1-	A	F2
C 4148	CHIP CAP.	0.01uF	50V	B	GRM188B11H103KA01D	K22174823		1-	A	F1
C 4152	CHIP CAP.	0.01uF	50V	B	GRM188B11H103KA01D	K22174823		1-	A	B1
C 4153	CHIP CAP.	0.01uF	50V	B	GRM188B11H103KA01D	K22174823		1-	A	C2
C 4158	CHIP CAP.	0.01uF	50V	B	GRM188B11H103KA01D	K22174823		1-	A	F1
C 4159	CHIP CAP.	0.01uF	50V	B	GRM188B11H103KA01D	K22174823		1-	A	F2
C 4161	CHIP CAP.	0.001uF	50V	B	GRM188B11H102KA01D	K22174821		1-	A	E2
C 4162	CHIP TA.CAP.	4.7uF	10V		TEMSVA1A475M-8R	K78100022		1-	A	C2
C 4163	CHIP TA.CAP.	4.7uF	10V		TEMSVA1A475M-8R	K78100022		1-	A	B1
C 4164	CHIP CAP.	0.001uF	50V	B	GRM188B11H102KA01D	K22174821		1-	A	H2
C 4165	CHIP TA.CAP.	4.7uF	10V		TEMSVA1A475M-8R	K78100022		1-	A	F2
C 4166	CHIP TA.CAP.	4.7uF	10V		TEMSVA1A475M-8R	K78100022		1-	A	F1
C 4167	CHIP CAP.	0.01uF	50V	B	GRM188B11H103KA01D	K22174823		1-	A	C2
C 4168	CHIP CAP.	0.01uF	50V	B	GRM188B11H103KA01D	K22174823		1-	A	F2
C 4169	CHIP CAP.	0.01uF	50V	B	GRM188B11H103KA01D	K22174823		1-	A	B1
C 4170	CHIP CAP.	0.01uF	50V	B	GRM188B11H103KA01D	K22174823		1-	A	F1
C 4171	CHIP CAP.	0.001uF	50V	B	GRM188B11H102KA01D	K22174821		1-	A	E2
C 4172	CHIP CAP.	0.01uF	50V	B	GRM188B11H103KA01D	K22174823		1-	A	C2
C 4173	CHIP CAP.	0.001uF	50V	B	GRM188B11H102KA01D	K22174821		1-	A	H2
C 4174	CHIP CAP.	0.01uF	50V	B	GRM188B11H103KA01D	K22174823		1-	A	F2
C 4175	CHIP CAP.	47pF	50V	CH	GRM1882C1H470JA01D	K22174227		1-	A	B1
C 4176	CHIP CAP.	47pF	50V	CH	GRM1882C1H470JA01D	K22174227		1-	A	E1
C 4177	CHIP CAP.	0.1uF	16V	B	GRM188B11C104KA01D	K22124805		1-	A	E2
C 4178	CHIP CAP.	0.1uF	16V	B	GRM188B11C104KA01D	K22124805		1-	A	H2
C 4179	CHIP CAP.	0.01uF	50V	B	GRM188B11H103KA01D	K22174823		1-	A	C1
C 4180	CHIP CAP.	0.01uF	50V	B	GRM188B11H103KA01D	K22174823		1-	A	F1
C 4181	CHIP CAP.	22pF	50V	CH	GRM1882C1H220JA01D	K22174219		1-	A	D1
C 4182	CHIP CAP.	0.01uF	50V	B	GRM188B11H103KA01D	K22174823		1-	A	A3
C 4183	CHIP CAP.	0.001uF	50V	B	GRM188B11H102KA01D	K22174821		1-	A	E2
C 4184	CHIP CAP.	0.001uF	50V	B	GRM188B11H102KA01D	K22174821		1-	A	H2
C 4187	CHIP CAP.	0.1uF	16V	B	GRM188B11C104KA01D	K22124805		1-	A	D1
C 4188	CHIP TA.CAP.	4.7uF	10V		TEMSVA1A475M-8R	K78100022		1-	A	D1
C 4189	CHIP CAP.	0.01uF	50V	B	GRM188B11H103KA01D	K22174823		1-	A	H2
C 4190	CHIP CAP.	0.01uF	50V	B	GRM188B11H103KA01D	K22174823		1-	A	E2
C 4191	CHIP CAP.	0.01uF	50V	B	GRM188B11H103KA01D	K22174823		1-	A	D1
C 4192	CHIP CAP.	0.01uF	50V	B	GRM188B11H103KA01D	K22174823		1-	A	D1
C 4199	CHIP CAP.	0.1uF	16V	B	GRM188B11C104KA01D	K22124805		1-	A	D1
C 4200	CHIP CAP.	0.01uF	50V	B	GRM188B11H103KA01D	K22174823		1-	A	D1
C 4201	CHIP TA.CAP.	4.7uF	10V		TEMSVA1A475M-8R	K78100022		1-	A	D1
C 4202	CHIP CAP.	39pF	50V	CH	GRM1882C1H390JA01D	K22174225		1-	A	E2
C 4203	CHIP CAP.	27pF	50V	CH	GRM1882C1H270JA01D	K22174221		1-	A	E2
C 4204	CHIP CAP.	0.01uF	50V	B	GRM188B11H103KA01D	K22174823		1-	A	C1
C 4205	CHIP CAP.	56pF	50V	CH	GRM1882C1H560JA01D	K22174229		1-	A	H2
C 4206	CHIP CAP.	39pF	50V	CH	GRM1882C1H390JA01D	K22174225		1-	A	H2
C 4207	CHIP CAP.	0.001uF	50V	B	GRM188B11H102KA01D	K22174821		1-	A	E2
C 4208	CHIP CAP.	0.01uF	50V	B	GRM188B11H103KA01D	K22174823		1-	A	E2
C 4212	CHIP CAP.	0.001uF	50V	B	GRM188B11H102KA01D	K22174821		1-	A	H2
C 4213	CHIP CAP.	0.001uF	50V	B	GRM188B11H102KA01D	K22174821		1-	A	H2
C 4214	CHIP CAP.	0.1uF	16V	B	GRM188B11C104KA01D	K22124805		1-	A	E3
C 4215	CHIP CAP.	0.1uF	16V	B	GRM188B11C104KA01D	K22124805		1-	A	E3
C 4216	CHIP CAP.	0.1uF	16V	B	GRM188B11C104KA01D	K22124805		1-	A	H3
C 4217	CHIP CAP.	0.1uF	16V	B	GRM188B11C104KA01D	K22124805		1-	A	H3
C 4218	CHIP CAP.	39pF	50V	CH	GRM1882C1H390JA01D	K22174225		1-	A	E3
C 4219	CHIP CAP.	27pF	50V	CH	GRM1882C1H270JA01D	K22174221		1-	A	E3
C 4220	CHIP CAP.	56pF	50V	CH	GRM1882C1H560JA01D	K22174229		1-	A	H3
C 4221	CHIP CAP.	39pF	50V	CH	GRM1882C1H390JA01D	K22174225		1-	A	H3
C 4222	CHIP CAP.	33pF	50V	CH	GRM1882C1H330JA01D	K22174223		1-	A	E3
C 4223	CHIP CAP.	22pF	50V	CH	GRM1882C1H220JA01D	K22174219		1-	A	E3
C 4224	CHIP TA.CAP.	1uF	25V		TEMSVA1E105M-8R	K78140013		1-	A	D1
C 4225	CHIP CAP.	39pF	50V	CH	GRM1882C1H390JA01D	K22174225		1-	A	H3
C 4226	CHIP CAP.	27pF	50V	CH	GRM1882C1H270JA01D	K22174221		1-	A	H3
C 4227	CHIP TA.CAP.	22uF			TPSB226M016Y0600	K78120075		1-	A	A2

LOCAL Unit

Parts List

REF	DESCRIPTION	VALUE	V/W	TOL.	MFR'S DESIG	VXSTD P/N	VERS.	LOT	SIDE	LAY ADR
C 4228	CHIP CAP.	6pF	50V	CH	GRM1882C1H6R0DZ01D	K22174207		1-	A	E3
C 4229	CHIP CAP.	4pF	50V	CH	GRM1882C1H4R0CZ01D	K22174205		1-	A	E3
C 4230	CHIP CAP.	15pF	50V	CH	GRM1882C1H150JA01D	K22174215		1-	A	H3
C 4231	CHIP CAP.	9pF	50V	CH	GRM1882C1H9R0DZ01D	K22174210		1-	A	H3
C 4232	CHIP CAP.	47pF	50V	CH	GRM1882C1H470JA01D	K22174227		1-	A	C1
C 4233	CHIP CAP.	0.1uF	16V	B	GRM188B11C104KA01D	K22124805		1-	A	A2
C 4234	CHIP CAP.	47pF	50V	CH	GRM1882C1H470JA01D	K22174227		1-	A	E3
C 4235	CHIP CAP.	39pF	50V	CH	GRM1882C1H390JA01D	K22174225		1-	A	E3
C 4236	CHIP CAP.	56pF	50V	CH	GRM1882C1H560JA01D	K22174229		1-	A	H3
C 4237	CHIP CAP.	39pF	50V	CH	GRM1882C1H390JA01D	K22174225		1-	A	H3
C 4238	CHIP CAP.	18pF	50V	CH	GRM1882C1H180JA01D	K22174217		1-	A	E3
C 4239	CHIP CAP.	12pF	50V	CH	GRM1882C1H120JA01D	K22174213		1-	A	E3
C 4240	CHIP CAP.	68pF	50V	CH	GRM1882C1H680JA01D	K22174231		1-	A	H3
C 4241	CHIP CAP.	33pF	50V	CH	GRM1882C1H330JA01D	K22174223		1-	A	H3
C 4242	CHIP CAP.	22pF	50V	CH	GRM1882C1H220JA01D	K22174219		1-	A	G1
C 4243	CHIP CAP.	22pF	50V	CH	GRM1882C1H220JA01D	K22174219		1-	A	E3
C 4244	CHIP CAP.	12pF	50V	CH	GRM1882C1H120JA01D	K22174213		1-	A	E3
C 4245	CHIP CAP.	22pF	50V	CH	GRM1882C1H220JA01D	K22174219		1-	A	H3
C 4246	CHIP CAP.	15pF	50V	CH	GRM1882C1H150JA01D	K22174215		1-	A	H3
C 4248	CHIP CAP.	0.01uF	50V	B	GRM188B11H103KA01D	K22174823		1-	A	E3
C 4249	CHIP CAP.	0.01uF	50V	B	GRM188B11H103KA01D	K22174823		1-	A	H3
C 4250	CHIP CAP.	0.01uF	50V	B	GRM188B11H103KA01D	K22174823		1-	A	E3
C 4250	CHIP CAP.	56pF	50V	CH	GRM1882C1H560JA01D	K22174229		4-	A	E3
C 4251	CHIP CAP.	0.01uF	50V	B	GRM188B11H103KA01D	K22174823		1-	A	H3
C 4252	CHIP CAP.	0.1uF	16V	B	GRM188B11C104KA01D	K22124805		1-	A	A2
C 4254	CHIP TA.CAP.	22uF			TPSB226M016Y0600	K78120075		1-	A	A2
C 4255	CHIP CAP.	0.1uF	16V	B	GRM188B11C104KA01D	K22124805		1-	A	G1
C 4256	CHIP TA.CAP.	4.7uF	10V		TEMSVA1A475M-8R	K78100022		1-	A	G1
C 4257	CHIP CAP.	0.1uF	16V	B	GRM188B11C104KA01D	K22124805		1-	A	A2
C 4258	CHIP CAP.	0.01uF	50V	B	GRM188B11H103KA01D	K22174823		1-	A	E3
C 4259	CHIP CAP.	0.01uF	50V	B	GRM188B11H103KA01D	K22174823		1-	A	G1
C 4260	CHIP CAP.	0.01uF	50V	B	GRM188B11H103KA01D	K22174823		1-	A	G1
C 4261	CHIP CAP.	0.01uF	50V	B	GRM188B11H103KA01D	K22174823		1-	A	H3
C 4262	CHIP CAP.	0.01uF	50V	B	GRM188B11H103KA01D	K22174823		1-	A	E2
C 4263	CHIP TA.CAP.	10uF	16V		TEESVA1C106M8R	K78120077		1-	A	E2
C 4264	CHIP CAP.	0.1uF	16V	B	GRM188B11C104KA01D	K22124805		1-	A	G1
C 4265	CHIP CAP.	0.01uF	50V	B	GRM188B11H103KA01D	K22174823		1-	A	G1
C 4266	CHIP CAP.	0.001uF	50V	B	GRM188B11H102KA01D	K22174821		1-	A	E3
C 4267	CHIP TA.CAP.	4.7uF	10V		TEMSVA1A475M-8R	K78100022		1-	A	G1
C 4268	CHIP CAP.	0.001uF	50V	B	GRM188B11H102KA01D	K22174821		1-	A	H3
C 4269	CHIP CAP.	0.01uF	50V	B	GRM188B11H103KA01D	K22174823		1-	A	G1
C 4270	CHIP CAP.	0.1uF	16V	B	GRM188B11C104KA01D	K22124805		1-	A	A2
C 4274	CHIP TA.CAP.	10uF	16V		TEESVA1C106M8R	K78120077		1-	A	A2
C 4282	CHIP TA.CAP.	1uF	25V		TEMSVA1E105M-8R	K78140013		1-	A	G1
C 4283	CHIP CAP.	47pF	50V	CH	GRM1882C1H470JA01D	K22174227		1-	A	G1
C 4284	CHIP TA.CAP.	10uF	16V		TEESVA1C106M8R	K78120077		1-	A	A1
C 4287	CHIP CAP.	0.01uF	50V	B	GRM188B11H103KA01D	K22174823		1-	A	A2
C 4288	CHIP CAP.	22pF	50V	CH	GRM1882C1H220JA01D	K22174219		1-	A	G1
C 4289	CHIP CAP.	0.01uF	50V	B	GRM188B11H103KA01D	K22174823		1-	A	B1
C 4290	CHIP CAP.	100pF	50V	CH	GRM1882C1H101JA01D	K22174235		1-	A	B1
C 4291	CHIP CAP.	0.01uF	50V	B	GRM188B11H103KA01D	K22174823		1-	A	B1
C 4292	CHIP CAP.	22pF	50V	CH	GRM1882C1H220JA01D	K22174219		1-	A	D1
C 4293	CHIP CAP.	47pF	50V	CH	GRM1882C1H470JA01D	K22174227		1-	A	B1
C 4294	CHIP CAP.	0.1uF	16V	B	GRM188B11C104KA01D	K22124805		1-	A	D1
C 4295	CHIP CAP.	0.1uF	16V	B	GRM188B11C104KA01D	K22124805		1-	A	G1
C 4296	CHIP CAP.	18pF	50V	CH	GRM1882C1H180JA01D	K22174217		1-	A	A1
C 4297	CHIP CAP.	0.01uF	50V	B	GRM188B11H103KA01D	K22174823		1-	A	B1
C 4298	CHIP CAP.	0.0012uF	50V	B	GRM188B11H122KA01D	K22174826		1-	A	D1
C 4299	CHIP CAP.	0.0012uF	50V	B	GRM188B11H122KA01D	K22174826		1-	A	G1
C 4300	CHIP CAP.	180pF	50V	CH	GRM1882C1H181JA01D	K22174241		1-	A	D1
C 4301	CHIP CAP.	180pF	50V	CH	GRM1882C1H181JA01D	K22174241		1-	A	G1
C 4302	CHIP CAP.	2pF	50V	CK	GRM1884C1H2R0CZ01D	K22174203		1-	A	A1
C 4303	CHIP CAP.	0.01uF	50V	B	GRM188B11H103KA01D	K22174823		1-	A	A1
C 4304	CHIP CAP.	0.0018uF	50V	B	GRM188B11H182KA01D	K22174828		1-	A	D1
C 4305	CHIP CAP.	0.0018uF	50V	B	GRM188B11H182KA01D	K22174828		1-	A	G1
C 4306	CHIP CAP.	560pF	50V	B	GRM188B11H561KA01D	K22174806		1-	A	D1
C 4307	CHIP CAP.	560pF	50V	B	GRM188B11H561KA01D	K22174806		1-	A	G1
C 4308	CHIP CAP.	15pF	50V	CH	GRM1882C1H150JA01D	K22174215		1-	A	A2
C 4309	CHIP CAP.	0.01uF	50V	B	GRM188B11H103KA01D	K22174823		1-	A	B1
C 4310	CHIP CAP.	5pF	50V	CH	GRM1882C1H5R0CZ01D	K22174206		1-	A	B1
C 4313	CHIP CAP.	0.01uF	50V	B	GRM188B11H103KA01D	K22174823		1-	A	B1
C 4314	CHIP CAP.	0.001uF	50V	B	GRM188B11H102KA01D	K22174821		1-	A	D1
C 4315	CHIP CAP.	0.001uF	50V	B	GRM188B11H102KA01D	K22174821		1-	A	G1

LOCAL Unit

Parts List

REF	DESCRIPTION	VALUE	V/W	TOL.	MFR'S DESIG	VXSTD P/N	VERS.	LOT	SIDE	LAY ADR
C 4316	CHIP CAP.	0.01uF	50V	B	GRM188B11H103KA01D	K22174823		1-	A	B1
C 4317	CHIP CAP.	10pF	50V	CH	GRM1882C1H100JA01D	K22174211		1-	A	E1
C 4318	CHIP CAP.	10pF	50V	CH	GRM1882C1H100JA01D	K22174211		1-	A	H1
C 4319	CHIP CAP.	82pF	50V	CH	GRM1882C1H820JA01D	K22174233		1-	A	B1
C 4320	CHIP TA.CAP.	0.1uF	35V		TESVA1V104M1-8R	K78160025		1-	A	A1
C 4321	CHIP CAP.	22pF	50V	CH	GRM1882C1H220JA01D	K22174219		1-	A	B1
C 4322	CHIP CAP.	82pF	50V	CH	GRM1882C1H820JA01D	K22174233		1-	A	B1
C 4323	CHIP CAP.	5pF	50V	CH	GRM1882C1H5R0CZ01D	K22174206		1-	A	A1
C 4324	CHIP CAP.	0.01uF	50V	B	GRM188B11H103KA01D	K22174823		1-	A	B2
C 4325	CHIP CAP.	68pF	50V	CH	GRM1882C1H680JA01D	K22174231		1-	A	B2
C 4326	CHIP CAP.	22pF	50V	CH	GRM1882C1H220JA01D	K22174219		1-	A	H1
C 4327	CHIP CAP.	82pF	50V	CH	GRM1882C1H820JA01D	K22174233		1-	A	A1
C 4330	CHIP CAP.	10pF	50V	CH	GRM1882C1H100JA01D	K22174211		1-	A	B2
C 4331	CHIP CAP.	4pF	50V	CH	GRM1882C1H4R0CZ01D	K22174205		1-	A	H1
C 4332	CHIP CAP.	82pF	50V	CH	GRM1882C1H820JA01D	K22174233		1-	A	A1
C 4333	CHIP CAP.	0.01uF	50V	B	GRM188B11H103KA01D	K22174823		1-	A	A2
C 4334	CHIP CAP.	0.01uF	50V	B	GRM188B11H103KA01D	K22174823		1-	A	H1
C 4335	CHIP CAP.	0.1uF	16V	B	GRM188B11C104KA01D	K22124805		1-	A	E1
C 4336	CHIP CAP.	0.1uF	16V	B	GRM188B11C104KA01D	K22124805		1-	A	H2
C 4337	CHIP CAP.	0.1uF	16V	B	GRM188B11C104KA01D	K22124805		1-	A	E1
C 4338	CHIP CAP.	0.1uF	16V	B	GRM188B11C104KA01D	K22124805		1-	A	H2
C 4339	CHIP CAP.	0.01uF	50V	B	GRM188B11H103KA01D	K22174823		1-	A	B2
C 4340	CHIP CAP.	0.01uF	50V	B	GRM188B11H103KA01D	K22174823		1-	A	H1
C 4341	CHIP CAP.	0.01uF	50V	B	GRM188B11H103KA01D	K22174823		1-	A	B2
C 4342	CHIP CAP.	0.01uF	50V	B	GRM188B11H103KA01D	K22174823		1-	A	H1
C 4343	CHIP CAP.	39pF	50V	CH	GRM1882C1H390JA01D	K22174225		1-	A	A3
C 4344	CHIP CAP.	56pF	50V	CH	GRM1882C1H560JA01D	K22174229		1-	A	H1
C 4345	CHIP CAP.	4pF	50V	CH	GRM1882C1H4R0CZ01D	K22174205		1-	A	A3
C 4346	CHIP CAP.	9pF	50V	CH	GRM1882C1H9R0DZ01D	K22174210		1-	A	H1
C 4347	CHIP CAP.	68pF	50V	CH	GRM1882C1H680JA01D	K22174231		1-	A	A3
C 4348	CHIP CAP.	82pF	50V	CH	GRM1882C1H820JA01D	K22174233		1-	A	H1
C 4349	CHIP CAP.	0.1uF	16V	B	GRM188B11C104KA01D	K22124805		1-	A	A1
C 4350	CHIP CAP.	12pF	50V	CH	GRM1882C1H120JA01D	K22174213		1-	A	A3
C 4351	CHIP CAP.	27pF	50V	CH	GRM1882C1H270JA01D	K22174221		1-	A	H1
C 4352	CHIP TA.CAP.	1uF	25V		TEMSVA1E105M-8R	K78140013		1-	A	A1
C 4353	CHIP CAP.	39pF	50V	CH	GRM1882C1H390JA01D	K22174225		1-	A	A3
C 4354	CHIP CAP.	39pF	50V	CH	GRM1882C1H390JA01D	K22174225		1-	A	H1
C 4357	CHIP CAP.	68pF	50V	CH	GRM1882C1H680JA01D	K22174231		1-	A	B2
C 4358	CHIP CAP.	47pF	50V	CH	GRM1882C1H470JA01D	K22174227		1-	A	A1
C 4359	CHIP CAP.	180pF	50V	CH	GRM1882C1H181JA01D	K22174241		1-	A	G2
C 4360	CHIP TA.CAP.	1uF	25V		TEMSVA1E105M-8R	K78140013		1-	A	G1
C 4361	CHIP CAP.	22pF	50V	CH	GRM1882C1H220JA01D	K22174219		1-	A	H1
C 4362	CHIP CAP.	22pF	50V	CH	GRM1882C1H220JA01D	K22174219		1-	A	B2
C 4363	CHIP TA.CAP.	4.7uF	10V		TEMSVA1A475M-8R	K78100022		1-	A	G1
C 4364	CHIP TA.CAP.	4.7uF	10V		TEMSVA1A475M-8R	K78100022		1-	A	G1
C 4369	CHIP CAP.	0.1uF	16V	B	GRM188B11C104KA01D	K22124805		1-	A	H1
C 4370	CHIP CAP.	0.1uF	16V	B	GRM188B11C104KA01D	K22124805		1-	A	G1
C 4371	CHIP CAP.	0.01uF	50V	B	GRM188B11H103KA01D	K22174823		1-	A	H1
C 4372	CHIP CAP.	0.01uF	50V	B	GRM188B11H103KA01D	K22174823		1-	A	G1
C 4373	CHIP CAP.	0.01uF	50V	B	GRM188B11H103KA01D	K22174823		1-	A	G1
C 4374	CHIP CAP.	0.01uF	50V	B	GRM188B11H103KA01D	K22174823		1-	A	G1
C 4379	CHIP CAP.	22pF	50V	CH	GRM1882C1H220JA01D	K22174219		1-	A	H1
C 4382	CHIP CAP.	0.01uF	50V	B	GRM188B11H103KA01D	K22174823		1-	A	E2
C 4383	CHIP TA.CAP.	0.1uF	35V		TESVA1V104M1-8R	K78160025		1-	A	E2
C 4400	CHIP TA.CAP.	0.1uF	35V		TESVA1V104M1-8R	K78160025		1-	A	E2
C 4401	CHIP TA.CAP.	0.1uF	35V		TESVA1V104M1-8R	K78160025		1-	A	H2
C 4402	CHIP CAP.	0.01uF	50V	B	GRM188B11H103KA01D	K22174823		1-	A	E2
C 4403	CHIP TA.CAP.	10uF	16V		TEESVA1C106M8R	K78120077		1-	A	E2
C 4404	CHIP TA.CAP.	4.7uF	10V		TEMSVA1A475M-8R	K78100022		1-	A	B2
C 4405	CHIP TA.CAP.	4.7uF	10V		TEMSVA1A475M-8R	K78100022		1-	A	F2
C 4406	CHIP CAP.	0.01uF	50V	B	GRM188B11H103KA01D	K22174823		1-	A	B2
C 4409	CHIP CAP.	0.01uF	50V	B	GRM188B11H103KA01D	K22174823		1-	A	H1
C 4411	CHIP CAP.	15pF	50V	CH	GRM1882C1H150JA01D	K22174215		4-		
C 4412	CHIP CAP.	15pF	50V	CH	GRM1882C1H150JA01D	K22174215		4-		
CF4001	CERAMIC FILTER				SFECV10M7FA00-R0-TC	H3900537		1-	A	C1
CF4002	CERAMIC FILTER				SFECV10M7FA00-R0-TC	H3900537		1-	A	F1
D 4001	DIODE				1SV325(TPH3.F)	G2070848		1-	A	B3
D 4002	DIODE				1SV323(TPH3.F)	G2071006		1-	A	C3
D 4003	DIODE				1SV325(TPH3.F)	G2070848		1-	A	C3
D 4004	DIODE				1SV325(TPH3.F)	G2070848		1-	A	D3
D 4005	DIODE				1SV325(TPH3.F)	G2070848		1-	A	F3
D 4006	DIODE				1SV325(TPH3.F)	G2070848		1-	A	F3
D 4007	DIODE				1SV325(TPH3.F)	G2070848		1-	A	G3

LOCAL Unit

Parts List

REF	DESCRIPTION	VALUE	V/W	TOL.	MFR'S DESIG	VXSTD P/N	VERS.	LOT	SIDE	LAY ADR
D 4008	DIODE				1SV323(TPH3.F)	G2071006		1-	A	G3
D 4009	DIODE				1SV325(TPH3.F)	G2070848		1-	A	B3
D 4010	DIODE				1SV323(TPH3.F)	G2071006		1-	A	C3
D 4011	DIODE				1SV325(TPH3.F)	G2070848		1-	A	C3
D 4012	DIODE				1SV325(TPH3.F)	G2070848		1-	A	D3
D 4013	DIODE				1SV325(TPH3.F)	G2070848		1-	A	F3
D 4014	DIODE				1SV325(TPH3.F)	G2070848		1-	A	F3
D 4015	DIODE				1SV325(TPH3.F)	G2070848		1-	A	G3
D 4016	DIODE				1SV323(TPH3.F)	G2071006		1-	A	G3
D 4017	DIODE				HSC277TRF-E	G2070584		1-	A	B2
D 4018	DIODE				HSC277TRF-E	G2070584		1-	A	C2
D 4019	DIODE				HSC277TRF-E	G2070584		1-	A	C2
D 4020	DIODE				HSC277TRF-E	G2070584		1-	A	D2
D 4021	DIODE				HSC277TRF-E	G2070584		1-	A	F2
D 4022	DIODE				HSC277TRF-E	G2070584		1-	A	F2
D 4023	DIODE				HSC277TRF-E	G2070584		1-	A	G2
D 4024	DIODE				HSC277TRF-E	G2070584		1-	A	G2
D 4025	DIODE				BAS316	G2070716		1-	A	B2
D 4026	DIODE				UDZS TE-17 6.2B	G2070912		1-	A	B2
D 4027	DIODE				DAP236U T106	G2070592		1-1	A	A1
D 4027	DIODE				DAP236U T106	G2070592		3-	A	A1
D 4028	DIODE				DAN235U TL	G2070176		1-	A	C2
D 4029	DIODE				DAN235U TL	G2070176		1-	A	D2
D 4030	DIODE				DAN235U TL	G2070176		1-	A	F2
D 4031	DIODE				DAN235U TL	G2070176		1-	A	G2
D 4032	DIODE				DAP236U T106	G2070592		1-	A	E2
D 4033	DIODE				DAP236U T106	G2070592		1-	A	H2
D 4034	DIODE				DAP236U T106	G2070592		1-	A	E3
D 4035	DIODE				DAP236U T106	G2070592		1-	A	H3
D 4036	DIODE				BAS316	G2070716		1-	A	E2
D 4037	DIODE				UDZS TE-17 5.1B	G2070908		1-	A	E2
D 4038	DIODE				BAS316	G2070716		1-	A	A2
D 4040	DIODE				HSC277TRF-E	G2070584		1-	A	B2
D 4042	DIODE				1SV325(TPH3.F)	G2070848		1-	A	F3
D 4043	DIODE				1SV325(TPH3.F)	G2070848		1-	A	F3
D 4044	DIODE				1SV325(TPH3.F)	G2070848		1-	A	F3
D 4045	DIODE				1SV325(TPH3.F)	G2070848		1-	A	F3
FB4001	FERRITE BEADS				BLM18BD601SN1D	L9190143		1-	A	A1
FB4002	FERRITE BEADS				BLM18BD601SN1D	L9190143		1-	A	A1
FB4003	FERRITE BEADS				BLM18BD601SN1D	L9190143		1-	A	A1
FB4004	FERRITE BEADS				BLM18BD601SN1D	L9190143		1-	A	A1
FB4005	FERRITE BEADS				BLM18BD601SN1D	L9190143		1-	A	A1
FB4006	FERRITE BEADS				BLM18BD601SN1D	L9190143		1-	A	A1
FB4007	FERRITE BEADS				BLM18BD601SN1D	L9190143		1-	A	A1
FB4008	FERRITE BEADS				BLM18BD601SN1D	L9190143		1-	A	A1
FB4009	FERRITE BEADS				BLM18BD601SN1D	L9190143		1-	A	A1
FB4010	FERRITE BEADS				BLM18BD601SN1D	L9190143		1-2	A	A1
FB4011	FERRITE BEADS				BLM18BD601SN1D	L9190143		1-2	A	A1
FB4012	CHIP COIL				BLM21PG300SN1D	L1690840		1-	A	A2
FB4013	FERRITE BEADS				BLM18BD601SN1D	L9190143		1-	A	A1
J 4001	CONNECTOR				30FLT-SM1-TB	P1091142		1-	A	A1
J 4002	CONNECTOR				TMP-J01X-V6	P1090210		1-	A	E3
J 4003	CONNECTOR				TMP-J01X-V6	P1090210		1-	A	E1
J 4004	CONNECTOR				TMP-J01X-V6	P1090210		1-	A	B3
J 4005	CONNECTOR				TMP-J01X-V6	P1090210		1-	A	H1
J 4006	CONNECTOR				TMP-J01X-V6	P1090210		1-	A	H2
J 4007	CONNECTOR				TMP-J01X-V6	P1090210		1-	A	H3
J 4008	CONNECTOR				TMP-J01X-V6	P1090210		1-	A	B2
L 4001	M.RFC	4.7uH			LLM3225-4R7J	L1691129		1-	A	B3
L 4002	M.RFC	4.7uH			LLM3225-4R7J	L1691129		1-	A	C3
L 4003	M.RFC	4.7uH			LLM3225-4R7J	L1691129		1-	A	C3
L 4004	M.RFC	4.7uH			LLM3225-4R7J	L1691129		1-	A	D3
L 4005	M.RFC	10uH			LLM3225-100J	L1691133		1-	A	F3
L 4006	M.RFC	10uH			LLM3225-100J	L1691133		1-	A	F3
L 4007	M.RFC	4.7uH			LLM3225-4R7J	L1691129		1-	A	G3
L 4008	M.RFC	4.7uH			LLM3225-4R7J	L1691129		1-	A	G3
L 4009	COIL				MC120 #222957	L0022758		1-	A	B3
L 4010	COIL				MC120 #222956	L0022757		1-	A	C3
L 4011	COIL				MC120 #222955	L0022756		1-	A	C3
L 4012	COIL				MC120 #222954	L0022755		1-	A	D3
L 4013	COIL	0.44uH			MC120 #E526HN-100309	L0190282		1-	A	F3
L 4013	COIL				MC120 #PE526HN-100525	L0190284		3-	A	F3
L 4014	COIL	0.35uH			MC120 #E526HN-100308	L0190281		1-	A	F3

LOCAL Unit

Parts List

REF	DESCRIPTION	VALUE	V/W	TOL.	MFR'S DESIG	VXSTD P/N	VERS.	LOT	SIDE	LAY ADR
L 4014	COIL				MC120 #PE526NN-100524	L0190283		3-	A	F3
L 4015	COIL				MC120 #222957	L0022758		1-	A	G3
L 4016	COIL				MC120 #222956	L0022757		1-	A	G3
L 4017	M.RFC	3.3uH			LLM3225-3R3J	L1691127		1-	A	B2
L 4018	M.RFC	3.3uH			LLM3225-3R3J	L1691127		1-	A	C2
L 4019	M.RFC	3.3uH			LLM3225-3R3J	L1691127		1-	A	D2
L 4020	M.RFC	3.3uH			LLM3225-3R3J	L1691127		1-	A	D2
L 4021	M.RFC	3.3uH			LLM3225-3R3J	L1691127		1-	A	F2
L 4022	M.RFC	3.3uH			LLM3225-3R3J	L1691127		1-	A	F2
L 4023	M.RFC	3.3uH			LLM3225-3R3J	L1691127		1-	A	G2
L 4024	M.RFC	3.3uH			LLM3225-3R3J	L1691127		1-	A	G2
L 4025	M.RFC	3.3uH			LLM3225-3R3J	L1691127		1-	A	D2
L 4026	M.RFC	3.3uH			LLM3225-3R3J	L1691127		1-	A	G2
L 4027	M.RFC	10uH			LLM3225-100J	L1691133		1-	A	B1
L 4028	M.RFC	10uH			LLM3225-100J	L1691133		1-	A	F1
L 4029	M.RFC	10uH			LLM3225-100J	L1691133		1-	A	B1
L 4030	M.RFC	10uH			LLM3225-100J	L1691133		1-	A	E1
L 4031	M.RFC	10uH			LLM3225-100J	L1691133		1-	A	C2
L 4032	M.RFC	10uH			LLM3225-100J	L1691133		1-	A	H2
L 4033	M.RFC	10uH			LLM3225-100J	L1691133		1-	A	F2
L 4034	M.RFC	10uH			LLM3225-100J	L1691133		1-	A	B1
L 4035	M.RFC	10uH			LLM3225-100J	L1691133		1-	A	E1
L 4036	M.RFC	0.33uH			LLM3225-R33J	L1691115		1-	A	E2
L 4037	M.RFC	0.33uH			LLM3225-R33J	L1691115		1-	A	H2
L 4038	M.RFC	10uH			LLM3225-100J	L1691133		1-	A	E2
L 4039	M.RFC	3.3uH			LLM3225-3R3J	L1691127		1-	A	H2
L 4040	M.RFC	3.3uH			LLM3225-3R3J	L1691127		1-	A	E2
L 4041	M.RFC	10uH			LLM3225-100J	L1691133		1-	A	D1
L 4042	M.RFC	10uH			LLM3225-100J	L1691133		1-	A	D1
L 4043	CHIP COIL	0.082uH		2%	C2520C-82NG	L1691293		1-	A	E3
L 4044	CHIP COIL	0.056uH		2%	C2520C-56NG	L1691291		1-	A	E3
L 4045	CHIP COIL	0.15uH		2%	C2520C-R15G	L1691296		1-	A	H3
L 4046	CHIP COIL	0.082uH		2%	C2520C-82NG	L1691293		1-	A	H3
L 4047	CHIP COIL	0.1uH			C2520C-R10J	L1690544		1-	A	E3
L 4048	CHIP COIL	0.068uH		2%	C2520C-68NG	L1691292		1-	A	E3
L 4049	CHIP COIL	0.12uH			C2520C-R12J	L1690545		1-	A	H3
L 4050	CHIP COIL	0.082uH		2%	C2520C-82NG	L1691293		1-	A	H3
L 4051	CHIP COIL	0.068uH		2%	C2520C-68NG	L1691292		1-	A	E3
L 4052	CHIP COIL	0.047uH		2%	C2520C-47NG	L1691290		1-	A	E3
L 4053	CHIP COIL	0.056uH		2%	C2520C-56NG	L1691291		1-	A	H3
L 4054	CHIP COIL	0.047uH		2%	C2520C-47NG	L1691290		1-	A	H3
L 4055	M.RFC	10uH			LLM3225-100J	L1691133		1-	A	G1
L 4056	M.RFC	3.3uH			LLM3225-3R3J	L1691127		1-	A	E3
L 4057	M.RFC	10uH			LLM3225-100J	L1691133		1-	A	G1
L 4058	M.RFC	3.3uH			LLM3225-3R3J	L1691127		1-	A	H3
L 4059	M.RFC	68uH			LLM3225-680J	L1691143		1-	A	D1
L 4060	M.RFC	68uH			LLM3225-680J	L1691143		1-	A	G1
L 4061	M.RFC	56uH			LLM3225-560J	L1691142		1-	A	D1
L 4062	M.RFC	56uH			LLM3225-560J	L1691142		1-	A	G1
L 4063	M.RFC	0.22uH			LLM3225-R22J	L1691113		1-	A	B1
L 4064	M.RFC	0.22uH			LLM3225-R22J	L1691113		1-	A	A1
L 4065	M.RFC	0.12uH			LLM3225-R12J	L1691110		1-	A	B3
L 4066	M.RFC	2.7uH			LLM3225-2R7J	L1691126		1-	A	H1
L 4067	M.RFC	0.1uH			LLM3225-R10J	L1691109		1-	A	B3
L 4068	M.RFC	1.8uH			LLM3225-1R8J	L1691124		1-	A	H1
L 4069	M.RFC	0.12uH			HK1608 R12J-T	L1690937		1-	A	A2
L 4070	M.RFC	10uH			LLM3225-100J	L1691133		1-	A	G1
L 4071	M.RFC	10uH			LLM3225-100J	L1691133		1-	A	G1
L 4072	M.RFC	0.22uH			HK1608 R22J-T	L1690940		1-	A	A2
L 4073	M.RFC	10uH			LLM3225-100J	L1691133		1-	A	E2
L 4074	M.RFC	10uH			LLM3225-100J	L1691133		1-	A	H2
L 4075	M.RFC	10uH			LK1608 100K-T	L1690689		1-	A	F3
L 4076	M.RFC	10uH			LK1608 100K-T	L1690689		1-	A	F3
L 4077	M.RFC	0.1uH		2%	C1608CB-R10G	L1691045		4-	A	
Q 4001	FET				2SK210-GR(TE85R.F)	G3802107G		1-	A	B2
Q 4002	FET				2SK210-GR(TE85R.F)	G3802107G		1-	A	C2
Q 4003	FET				2SK210-GR(TE85R.F)	G3802107G		1-	A	C2
Q 4004	FET				2SK210-GR(TE85R.F)	G3802107G		1-	A	D2
Q 4005	FET				2SK210-GR(TE85R.F)	G3802107G		1-	A	F2
Q 4006	FET				2SK210-GR(TE85R.F)	G3802107G		1-	A	F2
Q 4007	FET				2SK210-GR(TE85R.F)	G3802107G		1-	A	G2
Q 4008	FET				2SK210-GR(TE85R.F)	G3802107G		1-	A	G2
Q 4009	TRANSISTOR				DTC114EUA T106	G3070084		1-	A	C2

LOCAL Unit

Parts List

REF	DESCRIPTION	VALUE	V/W	TOL.	MFR'S DESIG	VXSTD P/N	VERS.	LOT	SIDE	LAY ADR
Q 4010	TRANSISTOR				DTC114EUA T106	G3070084		1-	A	C2
Q 4011	TRANSISTOR				DTC114EUA T106	G3070084		1-	A	D2
Q 4012	TRANSISTOR				DTC114EUA T106	G3070084		1-	A	D2
Q 4013	TRANSISTOR				DTC114EUA T106	G3070084		1-	A	F2
Q 4014	TRANSISTOR				DTC114EUA T106	G3070084		1-	A	F2
Q 4015	TRANSISTOR				DTC114EUA T106	G3070084		1-	A	G2
Q 4016	TRANSISTOR				DTC114EUA T106	G3070084		1-	A	G2
Q 4017	TRANSISTOR				2SC4154-T11-1E	G3341548E		1-	A	B2
Q 4018	TRANSISTOR				2SC4154-T11-1E	G3341548E		1-	A	H2
Q 4019	FET				2SK210-GR(TE85R.F)	G3802107G		1-	A	C2
Q 4020	FET				2SK210-GR(TE85R.F)	G3802107G		1-	A	G2
Q 4021	IC				AD9850BRSZ-REEL	G1092567		1-	A	C1
Q 4022	IC				AD9850BRSZ-REEL	G1092567		1-	A	F1
Q 4023	TRANSISTOR				2SC4400-4-TL	G3344008D		1-	A	C2
Q 4024	TRANSISTOR				2SC4400-4-TL	G3344008D		1-	A	F2
Q 4025	TRANSISTOR				2SC4400-4-TL	G3344008D		1-	A	D2
Q 4026	TRANSISTOR				2SC4400-4-TL	G3344008D		1-	A	G2
Q 4027	IC				ADF4001BRUZ-REEL7	G1093977		1-	A	C2
Q 4028	IC				ADF4001BRUZ-REEL7	G1093977		1-	A	F2
Q 4029	IC				UPC2710TB-E3	G1093932		1-	A	E2
Q 4030	IC				UPC2710TB-E3	G1093932		1-	A	H2
Q 4031	TRANSISTOR				2SC4400-4-TL	G3344008D		1-	A	B1
Q 4032	TRANSISTOR				2SC4400-4-TL	G3344008D		1-	A	E1
Q 4033	TRANSISTOR				2SC4400-4-TL	G3344008D		1-	A	C1
Q 4034	TRANSISTOR				2SC4400-4-TL	G3344008D		1-	A	F1
Q 4035	IC				NJU3712A(TAPE)	G1094290		1-	A	A3
Q 4036	IC				AD9834BRUZ-REEL7	G1094297		1-	A	D1
Q 4037	TRANSISTOR				DTC114EUA T106	G3070084		1-	A	E2
Q 4038	TRANSISTOR				DTC114EUA T106	G3070084		1-	A	E2
Q 4039	TRANSISTOR				DTC114EUA T106	G3070084		1-	A	H2
Q 4040	TRANSISTOR				DTC114EUA T106	G3070084		1-	A	H2
Q 4041	TRANSISTOR				2SC4400-4-TL	G3344008D		1-	A	D1
Q 4042	TRANSISTOR				DTC114EUA T106	G3070084		1-	A	D1
Q 4043	IC				BA033CC0FP-E2	G1094077		1-	A	A2
Q 4044	IC				AD9834BRUZ-REEL7	G1094297		1-	A	G1
Q 4045	TRANSISTOR				2SC4154-T11-1E	G3341548E		1-	A	E2
Q 4046	IC				KIA7808API	G1093164		1-	A	A2
Q 4047	TRANSISTOR				2SC4400-4-TL	G3344008D		1-	A	G1
Q 4048	IC				TA75S01F(TE85R.F)	G1091593		1-	A	A2
Q 4049	TRANSISTOR				2SC4400-4-TL	G3344008D		1-	A	A1
Q 4050	TRANSISTOR				2SC4400-4-TL	G3344008D		1-	A	B1
Q 4051	TRANSISTOR				2SC4400-4-TL	G3344008D		1-	A	B1
Q 4052	TRANSISTOR				2SC4400-4-TL	G3344008D		1-	A	B1
Q 4053	TRANSISTOR				2SC4154-T11-1E	G3341548E		1-	A	E2
Q 4054	TRANSISTOR				2SC4154-T11-1E	G3341548E		1-	A	E1
Q 4056	TRANSISTOR				2SC4400-4-TL	G3344008D		1-	A	A2
Q 4057	TRANSISTOR				2SC4400-4-TL	G3344008D		1-	A	H1
Q 4058	TRANSISTOR				2SC4154-T11-1E	G3341548E		1-	A	E1
Q 4059	TRANSISTOR				2SC4154-T11-1E	G3341548E		1-	A	H2
Q 4061	TRANSISTOR				2SC4400-4-TL	G3344008D		1-	A	B2
Q 4062	TRANSISTOR				2SC4400-4-TL	G3344008D		1-	A	H1
Q 4063	IC				AD9834BRUZ-REEL7	G1094297		1-	A	G1
Q 4064	TRANSISTOR				2SC4400-4-TL	G3344008D		1-	A	G1
R 4001	CHIP RES.	47	1/16W	5%	RMC1/16 470JATP	J24185470		1-	A	B3
R 4002	CHIP RES.	47	1/16W	5%	RMC1/16 470JATP	J24185470		1-	A	C3
R 4003	CHIP RES.	47	1/16W	5%	RMC1/16 470JATP	J24185470		1-	A	C3
R 4004	CHIP RES.	47	1/16W	5%	RMC1/16 470JATP	J24185470		1-	A	D3
R 4005	CHIP RES.	47	1/16W	5%	RMC1/16 470JATP	J24185470		1-	A	F3
R 4006	CHIP RES.	47	1/16W	5%	RMC1/16 470JATP	J24185470		1-	A	F3
R 4007	CHIP RES.	47	1/16W	5%	RMC1/16 470JATP	J24185470		1-	A	G3
R 4008	CHIP RES.	47	1/16W	5%	RMC1/16 470JATP	J24185470		1-	A	G3
R 4009	CHIP RES.	100k	1/16W	5%	RMC1/16 104JATP	J24185104		1-	A	B2
R 4010	CHIP RES.	100k	1/16W	5%	RMC1/16 104JATP	J24185104		1-	A	C2
R 4011	CHIP RES.	100k	1/16W	5%	RMC1/16 104JATP	J24185104		1-	A	C2
R 4012	CHIP RES.	100k	1/16W	5%	RMC1/16 104JATP	J24185104		1-	A	D2
R 4013	CHIP RES.	100k	1/16W	5%	RMC1/16 104JATP	J24185104		1-	A	F2
R 4014	CHIP RES.	100k	1/16W	5%	RMC1/16 104JATP	J24185104		1-	A	F2
R 4015	CHIP RES.	100k	1/16W	5%	RMC1/16 104JATP	J24185104		1-	A	G2
R 4016	CHIP RES.	100k	1/16W	5%	RMC1/16 104JATP	J24185104		1-	A	G2
R 4025	CHIP RES.	150	1/16W	5%	RMC1/16 151JATP	J24185151		1-	A	C2
R 4025	CHIP RES.	330	1/16W	5%	RMC1/16 331JATP	J24185331		4-	A	C2
R 4026	CHIP RES.	150	1/16W	5%	RMC1/16 151JATP	J24185151		1-	A	C2
R 4026	CHIP RES.	330	1/16W	5%	RMC1/16 331JATP	J24185331		3-	A	C2

LOCAL Unit

Parts List

REF	DESCRIPTION	VALUE	V/W	TOL.	MFR'S DESIG	VXSTD P/N	VERS.	LOT	SIDE	LAY ADR
R 4027	CHIP RES.	150	1/16W	5%	RMC1/16 151JATP	J24185151		1-	A	D2
R 4027	CHIP RES.	330	1/16W	5%	RMC1/16 331JATP	J24185331		4-	A	D2
R 4028	CHIP RES.	150	1/16W	5%	RMC1/16 151JATP	J24185151		1-	A	D2
R 4028	CHIP RES.	330	1/16W	5%	RMC1/16 331JATP	J24185331		4-	A	D2
R 4029	CHIP RES.	330	1/16W	5%	RMC1/16 331JATP	J24185331		1-	A	F2
R 4030	CHIP RES.	150	1/16W	5%	RMC1/16 151JATP	J24185151		1-	A	F2
R 4030	CHIP RES.	330	1/16W	5%	RMC1/16 331JATP	J24185331		3-	A	F2
R 4031	CHIP RES.	150	1/16W	5%	RMC1/16 151JATP	J24185151		1-	A	G2
R 4031	CHIP RES.	330	1/16W	5%	RMC1/16 331JATP	J24185331		3-	A	G2
R 4032	CHIP RES.	150	1/16W	5%	RMC1/16 151JATP	J24185151		1-	A	G2
R 4032	CHIP RES.	330	1/16W	5%	RMC1/16 331JATP	J24185331		3-	A	G2
R 4034	CHIP RES.	1k	1/16W	5%	RMC1/16 102JATP	J24185102		1-	A	B2
R 4036	CHIP RES.	1k	1/16W	5%	RMC1/16 102JATP	J24185102		1-	A	C2
R 4038	CHIP RES.	1k	1/16W	5%	RMC1/16 102JATP	J24185102		1-	A	D2
R 4040	CHIP RES.	1k	1/16W	5%	RMC1/16 102JATP	J24185102		1-	A	D2
R 4042	CHIP RES.	1k	1/16W	5%	RMC1/16 102JATP	J24185102		1-	A	F2
R 4044	CHIP RES.	1k	1/16W	5%	RMC1/16 102JATP	J24185102		1-	A	F2
R 4046	CHIP RES.	1k	1/16W	5%	RMC1/16 102JATP	J24185102		1-	A	G2
R 4048	CHIP RES.	1k	1/16W	5%	RMC1/16 102JATP	J24185102		1-	A	G2
R 4049	CHIP RES.	47	1/16W	5%	RMC1/16 470JATP	J24185470		1-	A	F2
R 4050	CHIP RES.	47	1/16W	5%	RMC1/16 470JATP	J24185470		1-	A	F2
R 4051	CHIP RES.	47	1/16W	5%	RMC1/16 470JATP	J24185470		1-	A	G2
R 4052	CHIP RES.	47	1/16W	5%	RMC1/16 470JATP	J24185470		1-	A	G2
R 4053	CHIP RES.	47	1/16W	5%	RMC1/16 470JATP	J24185470		1-	A	B2
R 4054	CHIP RES.	47	1/16W	5%	RMC1/16 470JATP	J24185470		1-	A	C2
R 4055	CHIP RES.	47	1/16W	5%	RMC1/16 470JATP	J24185470		1-	A	C2
R 4056	CHIP RES.	47	1/16W	5%	RMC1/16 470JATP	J24185470		1-	A	D2
R 4057	CHIP RES.	100	1/16W	5%	RMC1/16 101JATP	J24185101		1-	A	G2
R 4058	CHIP RES.	1k	1/16W	5%	RMC1/16 102JATP	J24185102		1-	A	G2
R 4059	CHIP RES.	1k	1/16W	5%	RMC1/16 102JATP	J24185102		1-	A	D2
R 4060	CHIP RES.	47	1/16W	5%	RMC1/16 470JATP	J24185470		1-	A	C1
R 4061	CHIP RES.	47	1/16W	5%	RMC1/16 470JATP	J24185470		1-	A	F1
R 4063	CHIP RES.	1k	1/16W	5%	RMC1/16 102JATP	J24185102		1-	A	B2
R 4065	CHIP RES.	100	1/16W	5%	RMC1/16 101JATP	J24185101		1-	A	D2
R 4066	CHIP RES.	1k	1/16W	5%	RMC1/16 102JATP	J24185102		1-	A	H2
R 4068	CHIP RES.	0	1/16W	5%	RMC1/16 000JATP	J24185000		1-	A	A1
R 4069	CHIP RES.	47	1/16W	5%	RMC1/16 470JATP	J24185470		1-	A	C2
R 4070	CHIP RES.	100k	1/16W	5%	RMC1/16 104JATP	J24185104		1-	A	D2
R 4071	CHIP RES.	470	1/16W	5%	RMC1/16 471JATP	J24185471		1-	A	B2
R 4072	CHIP RES.	100k	1/16W	5%	RMC1/16 104JATP	J24185104		1-	A	G2
R 4073	CHIP RES.	470	1/16W	5%	RMC1/16 471JATP	J24185471		1-	A	F2
R 4074	CHIP RES.	47	1/16W	5%	RMC1/16 470JATP	J24185470		1-	A	G2
R 4075	CHIP RES.	0	1/16W	5%	RMC1/16 000JATP	J24185000		1-	A	B2
R 4076	CHIP RES.	0	1/16W	5%	RMC1/16 000JATP	J24185000		1-	A	E2
R 4077	CHIP RES.	0	1/16W	5%	RMC1/16 000JATP	J24185000		1-	A	B2
R 4078	CHIP RES.	470	1/16W	5%	RMC1/16 471JATP	J24185471		1-	A	C2
R 4079	CHIP RES.	0	1/16W	5%	RMC1/16 000JATP	J24185000		1-	A	F1
R 4080	CHIP RES.	100	1/16W	5%	RMC1/16 101JATP	J24185101		1-	A	C2
R 4081	CHIP RES.	470	1/16W	5%	RMC1/16 471JATP	J24185471		1-	A	D2
R 4081	CHIP RES.	100	1/16W	5%	RMC1/16 101JATP	J24185101		4-	A	D2
R 4082	CHIP RES.	100	1/16W	5%	RMC1/16 101JATP	J24185101		1-	A	G2
R 4083	CHIP RES.	470	1/16W	5%	RMC1/16 471JATP	J24185471		1-	A	G2
R 4084	CHIP RES.	470	1/16W	5%	RMC1/16 471JATP	J24185471		1-	A	F2
R 4085	CHIP RES.	100	1/16W	5%	RMC1/16 101JATP	J24185101		1-	A	B2
R 4086	CHIP RES.	100	1/16W	5%	RMC1/16 101JATP	J24185101		1-	A	F2
R 4087	CHIP RES.	39k	1/16W	5%	RMC1/16 393JATP	J24185393		1-	A	C2
R 4088	CHIP RES.	39k	1/16W	5%	RMC1/16 393JATP	J24185393		1-	A	F2
R 4089	CHIP RES.	820	1/16W	5%	RMC1/16 821JATP	J24185821		1-	A	B2
R 4090	CHIP RES.	820	1/16W	5%	RMC1/16 821JATP	J24185821		1-	A	F2
R 4091	CHIP RES.	82k	1/16W	5%	RMC1/16 823JATP	J24185823		1-	A	D2
R 4092	CHIP RES.	82k	1/16W	5%	RMC1/16 823JATP	J24185823		1-	A	G2
R 4093	CHIP RES.	47	1/16W	5%	RMC1/16 470JATP	J24185470		1-	A	C1
R 4094	CHIP RES.	47	1/16W	5%	RMC1/16 470JATP	J24185470		1-	A	C1
R 4095	CHIP RES.	47	1/16W	5%	RMC1/16 470JATP	J24185470		1-	A	F1
R 4096	CHIP RES.	47	1/16W	5%	RMC1/16 470JATP	J24185470		1-	A	F1
R 4097	CHIP RES.	47	1/16W	5%	RMC1/16 470JATP	J24185470		1-	A	D2
R 4098	CHIP RES.	1k	1/16W	5%	RMC1/16 102JATP	J24185102		1-	A	D2
R 4099	CHIP RES.	4.7k	1/16W	5%	RMC1/16 472JATP	J24185472		1-	A	B2
R 4100	CHIP RES.	100k	1/16W	5%	RMC1/16 104JATP	J24185104		1-	A	E1
R 4101	CHIP RES.	47	1/16W	5%	RMC1/16 470JATP	J24185470		1-	A	G2
R 4102	CHIP RES.	1k	1/16W	5%	RMC1/16 102JATP	J24185102		1-	A	G2
R 4103	CHIP RES.	10k	1/16W	5%	RMC1/16 103JATP	J24185103		1-	A	F2
R 4105	CHIP RES.	47	1/16W	5%	RMC1/16 470JATP	J24185470		1-	A	B1

LOCAL Unit

Parts List

REF	DESCRIPTION	VALUE	V/W	TOL.	MFR'S DESIG	VXSTD P/N	VERS.	LOT	SIDE	LAY ADR
R 4106	CHIP RES.	47	1/16W	5%	RMC1/16 470JATP	J24185470		1-	A	B1
R 4107	CHIP RES.	47	1/16W	5%	RMC1/16 470JATP	J24185470		1-	A	B1
R 4108	CHIP RES.	47	1/16W	5%	RMC1/16 470JATP	J24185470		1-	A	F1
R 4109	CHIP RES.	47	1/16W	5%	RMC1/16 470JATP	J24185470		1-	A	F1
R 4110	CHIP RES.	47	1/16W	5%	RMC1/16 470JATP	J24185470		1-	A	F1
R 4111	CHIP RES.	47	1/16W	0.5%	RGC1/16C470DTP	J24189396		1-	A	C1
R 4112	CHIP RES.	47	1/16W	0.5%	RGC1/16C470DTP	J24189396		1-	A	F1
R 4113	CHIP RES.	10	1/16W	5%	RMC1/16 100JATP	J24185100		1-	A	D2
R 4114	CHIP RES.	10	1/16W	5%	RMC1/16 100JATP	J24185100		1-	A	G2
R 4115	CHIP RES.	47	1/16W	0.5%	RGC1/16C470DTP	J24189396		1-	A	C1
R 4116	CHIP RES.	47	1/16W	0.5%	RGC1/16C470DTP	J24189396		1-	A	C1
R 4117	CHIP RES.	47	1/16W	0.5%	RGC1/16C470DTP	J24189396		1-	A	F1
R 4118	CHIP RES.	47	1/16W	0.5%	RGC1/16C470DTP	J24189396		1-	A	F1
R 4119	CHIP RES.	150	1/16W	5%	RMC1/16 151JATP	J24185151		1-3	A	D2
R 4120	CHIP RES.	150	1/16W	5%	RMC1/16 151JATP	J24185151		1-	A	G2
R 4121	CHIP RES.	10	1/16W	5%	RMC1/16 100JATP	J24185100		1-	A	D2
R 4122	CHIP RES.	10	1/16W	5%	RMC1/16 100JATP	J24185100		1-	A	G2
R 4125	CHIP RES.	3.9k	1/16W	5%	RMC1/16 392JATP	J24185392		1-	A	B1
R 4126	CHIP RES.	3.9k	1/16W	5%	RMC1/16 392JATP	J24185392		1-	A	F1
R 4127	CHIP RES.	1k	1/16W	5%	RMC1/16 102JATP	J24185102		1-	A	C1
R 4128	CHIP RES.	0	1/16W	5%	RMC1/16 000JATP	J24185000		1-	A	B1
R 4129	CHIP RES.	1k	1/16W	5%	RMC1/16 102JATP	J24185102		1-	A	F1
R 4130	CHIP RES.	0	1/16W	5%	RMC1/16 000JATP	J24185000		1-	A	F1
R 4131	CHIP RES.	1k	1/16W	5%	RMC1/16 102JATP	J24185102		1-	A	C1
R 4132	CHIP RES.	1k	1/16W	5%	RMC1/16 102JATP	J24185102		1-	A	F1
R 4133	CHIP RES.	47	1/16W	5%	RMC1/16 470JATP	J24185470		1-	A	B1
R 4134	CHIP RES.	390	1/16W	5%	RMC1/16 391JATP	J24185391		1-	A	B1
R 4135	CHIP RES.	47	1/16W	5%	RMC1/16 470JATP	J24185470		1-	A	F1
R 4136	CHIP RES.	390	1/16W	5%	RMC1/16 391JATP	J24185391		1-	A	F1
R 4137	CHIP RES.	47	1/16W	5%	RMC1/16 470JATP	J24185470		1-	A	C2
R 4138	CHIP RES.	22k	1/16W	5%	RMC1/16 223JATP	J24185223		1-	A	B1
R 4139	CHIP RES.	47	1/16W	5%	RMC1/16 470JATP	J24185470		1-	A	F2
R 4140	CHIP RES.	22k	1/16W	5%	RMC1/16 223JATP	J24185223		1-	A	E1
R 4141	CHIP RES.	390	1/16W	5%	RMC1/16 391JATP	J24185391		1-	A	C2
R 4142	CHIP RES.	390	1/16W	5%	RMC1/16 391JATP	J24185391		1-	A	F2
R 4143	CHIP RES.	22k	1/16W	5%	RMC1/16 223JATP	J24185223		1-	A	C1
R 4144	CHIP RES.	22k	1/16W	5%	RMC1/16 223JATP	J24185223		1-	A	F1
R 4145	CHIP RES.	220	1/16W	5%	RMC1/16 221JATP	J24185221		1-	A	D1
R 4146	CHIP RES.	6.8k	1/16W	5%	RMC1/16 682JATP	J24185682		1-	A	D1
R 4147	CHIP RES.	100	1/16W	5%	RMC1/16 101JATP	J24185101		1-	A	H2
R 4148	CHIP RES.	1k	1/16W	5%	RMC1/16 102JATP	J24185102		1-	A	H2
R 4149	CHIP RES.	100	1/16W	5%	RMC1/16 101JATP	J24185101		1-	A	E2
R 4150	CHIP RES.	1k	1/16W	5%	RMC1/16 102JATP	J24185102		1-	A	E2
R 4151	CHIP RES.	47	1/16W	5%	RMC1/16 470JATP	J24185470		1-	A	E2
R 4152	CHIP RES.	47	1/16W	5%	RMC1/16 470JATP	J24185470		1-	A	E2
R 4153	CHIP RES.	47	1/16W	5%	RMC1/16 470JATP	J24185470		1-	A	H2
R 4154	CHIP RES.	47	1/16W	5%	RMC1/16 470JATP	J24185470		1-	A	H2
R 4155	CHIP RES.	47k	1/16W	5%	RMC1/16 473JATP	J24185473		1-	A	E2
R 4156	CHIP RES.	47	1/16W	5%	RMC1/16 470JATP	J24185470		1-	A	C1
R 4157	CHIP RES.	47k	1/16W	5%	RMC1/16 473JATP	J24185473		1-	A	H2
R 4158	CHIP RES.	47k	1/16W	5%	RMC1/16 473JATP	J24185473		1-	A	E2
R 4159	CHIP RES.	1k	1/16W	5%	RMC1/16 102JATP	J24185102		1-	A	E2
R 4160	CHIP RES.	47	1/16W	5%	RMC1/16 470JATP	J24185470		1-	A	C1
R 4161	CHIP RES.	47k	1/16W	5%	RMC1/16 473JATP	J24185473		1-	A	H2
R 4162	CHIP RES.	1k	1/16W	5%	RMC1/16 102JATP	J24185102		1-	A	H2
R 4163	CHIP RES.	1k	1/16W	5%	RMC1/16 102JATP	J24185102		1-	A	E2
R 4164	CHIP RES.	47	1/16W	5%	RMC1/16 470JATP	J24185470		1-	A	D1
R 4165	CHIP RES.	1k	1/16W	5%	RMC1/16 102JATP	J24185102		1-	A	H2
R 4166	CHIP RES.	0	1/16W	5%	RMC1/16 000JATP	J24185000		1-	A	D1
R 4167	CHIP RES.	390	1/16W	5%	RMC1/16 391JATP	J24185391		1-	A	D1
R 4168	CHIP RES.	47	1/16W	5%	RMC1/16 470JATP	J24185470		1-	A	D1
R 4169	CHIP RES.	22k	1/16W	5%	RMC1/16 223JATP	J24185223		1-	A	D1
R 4170	CHIP RES.	100	1/16W	5%	RMC1/16 101JATP	J24185101		1-	A	E3
R 4171	CHIP RES.	100	1/16W	5%	RMC1/16 101JATP	J24185101		1-	A	E3
R 4171	CHIP RES.	1k	1/16W	5%	RMC1/16 102JATP	J24185102		4-	A	E3
R 4172	CHIP RES.	100	1/16W	5%	RMC1/16 101JATP	J24185101		1-	A	H3
R 4173	CHIP RES.	100	1/16W	5%	RMC1/16 101JATP	J24185101		1-	A	H3
R 4174	CHIP RES.	100k	1/16W	5%	RMC1/16 104JATP	J24185104		1-	A	D1
R 4175	CHIP RES.	220	1/16W	5%	RMC1/16 221JATP	J24185221		1-	A	G1
R 4176	CHIP RES.	1k	1/16W	5%	RMC1/16 102JATP	J24185102		1-	A	E3
R 4177	CHIP RES.	1k	1/16W	5%	RMC1/16 102JATP	J24185102		1-	A	H3
R 4178	CHIP RES.	47k	1/16W	5%	RMC1/16 473JATP	J24185473		1-	A	E3
R 4179	CHIP RES.	1k	1/16W	5%	RMC1/16 102JATP	J24185102		1-3	A	E3

LOCAL Unit

Parts List

REF	DESCRIPTION	VALUE	V/W	TOL.	MFR'S DESIG	VXSTD P/N	VERS.	LOT	SIDE	LAY ADR
R 4180	CHIP RES.	47k	1/16W	5%	RMC1/16 473JATP	J24185473		1-	A	H3
R 4181	CHIP RES.	1k	1/16W	5%	RMC1/16 102JATP	J24185102		1-	A	H3
R 4182	CHIP RES.	47k	1/16W	5%	RMC1/16 473JATP	J24185473		1-	A	E3
R 4183	CHIP RES.	47k	1/16W	5%	RMC1/16 473JATP	J24185473		1-	A	H3
R 4184	CHIP RES.	6.8k	1/16W	5%	RMC1/16 682JATP	J24185682		1-	A	G1
R 4187	CHIP RES.	0	1/16W	5%	RMC1/16 000JATP	J24185000		1-	A	A1
R 4188	CHIP RES.	100	1/16W	5%	RMC1/16 101JATP	J24185101		1-	A	E3
R 4189	CHIP RES.	1k	1/16W	5%	RMC1/16 102JATP	J24185102		1-	A	E3
R 4190	CHIP RES.	100	1/16W	5%	RMC1/16 101JATP	J24185101		1-	A	H3
R 4191	CHIP RES.	1k	1/16W	5%	RMC1/16 102JATP	J24185102		1-	A	H3
R 4192	CHIP RES.	0	1/16W	5%	RMC1/16 000JATP	J24185000		1-	A	A1
R 4193	CHIP RES.	47	1/16W	5%	RMC1/16 470JATP	J24185470		1-	A	G1
R 4194	CHIP RES.	1k	1/16W	5%	RMC1/16 102JATP	J24185102		1-	A	E2
R 4195	CHIP RES.	47	1/16W	5%	RMC1/16 470JATP	J24185470		1-	A	G1
R 4196	CHIP RES.	47	1/16W	5%	RMC1/16 470JATP	J24185470		1-	A	G1
R 4197	CHIP RES.	0	1/16W	5%	RMC1/16 000JATP	J24185000		1-	A	G1
R 4198	CHIP RES.	390	1/16W	5%	RMC1/16 391JATP	J24185391		1-	A	G1
R 4199	CHIP RES.	47	1/16W	5%	RMC1/16 470JATP	J24185470		1-	A	G1
R 4200	CHIP RES.	22k	1/16W	5%	RMC1/16 223JATP	J24185223		1-	A	G1
R 4201	CHIP RES.	100k	1/16W	5%	RMC1/16 104JATP	J24185104		1-	A	G1
R 4202	CHIP RES.	39k	1/16W	1%	RMC1/16 393FTP	J24183393		1-	A	A2
R 4203	CHIP RES.	11k	1/16W	1%	RMC1/16 113FTP	J24183113		1-	A	A1
R 4204	CHIP RES.	220	1/16W	5%	RMC1/16 221JATP	J24185221		1-	A	D1
R 4205	CHIP RES.	220	1/16W	5%	RMC1/16 221JATP	J24185221		1-	A	G1
R 4206	CHIP RES.	10k	1/16W	1%	RMC1/16 103FTP	J24183103		1-	A	A1
R 4207	CHIP RES.	82k	1/16W	5%	RMC1/16 823JATP	J24185823		1-	A	B1
R 4209	CHIP RES.	47	1/16W	5%	RMC1/16 470JATP	J24185470		1-	A	B1
R 4210	CHIP RES.	1k	1/16W	5%	RMC1/16 102JATP	J24185102		1-	A	B1
R 4211	CHIP RES.	1.5k	1/16W	1%	RMC1/16 152FTP	J24183152		1-	A	A2
R 4212	CHIP RES.	33k	1/16W	5%	RMC1/16 333JATP	J24185333		1-	A	B1
R 4213	CHIP RES.	100	1/16W	5%	RMC1/16 101JATP	J24185101		1-	A	B1
R 4214	CHIP RES.	1k	1/16W	5%	RMC1/16 102JATP	J24185102		1-	A	B1
R 4215	CHIP RES.	82k	1/16W	5%	RMC1/16 823JATP	J24185823		1-	A	B1
R 4217	CHIP RES.	470	1/16W	5%	RMC1/16 471JATP	J24185471		1-	A	A1
R 4218	CHIP RES.	10k	1/16W	5%	RMC1/16 103JATP	J24185103		1-	A	B1
R 4219	CHIP RES.	47	1/16W	5%	RMC1/16 470JATP	J24185470		1-	A	B1
R 4220	CHIP RES.	1k	1/16W	1%	RMC1/16 102FTP	J24183102		1-	A	A2
R 4221	CHIP RES.	1k	1/16W	5%	RMC1/16 102JATP	J24185102		1-	A	B1
R 4225	CHIP RES.	82k	1/16W	5%	RMC1/16 823JATP	J24185823		1-	A	B1
R 4227	CHIP RES.	0	1/16W	5%	RMC1/16 000JATP	J24185000		1-	A	E1
R 4230	CHIP RES.	0	1/16W	5%	RMC1/16 000JATP	J24185000		1-	A	H2
R 4232	CHIP RES.	82k	1/16W	5%	RMC1/16 823JATP	J24185823		1-	A	B2
R 4233	CHIP RES.	82k	1/16W	5%	RMC1/16 823JATP	J24185823		1-	A	H1
R 4234	CHIP RES.	0	1/16W	5%	RMC1/16 000JATP	J24185000		1-	A	E1
R 4235	CHIP RES.	0	1/16W	5%	RMC1/16 000JATP	J24185000		1-	A	H1
R 4237	CHIP RES.	1.2k	1/16W	5%	RMC1/16 122JATP	J24185122		1-	A	E1
R 4238	CHIP RES.	82k	1/16W	5%	RMC1/16 823JATP	J24185823		1-	A	H1
R 4239	CHIP RES.	1k	1/16W	5%	RMC1/16 102JATP	J24185102		1-	A	B2
R 4241	CHIP RES.	0	1/16W	5%	RMC1/16 000JATP	J24185000		1-	A	A2
R 4242	CHIP RES.	0	1/16W	5%	RMC1/16 000JATP	J24185000		1-	A	H1
R 4243	CHIP RES.	1k	1/16W	5%	RMC1/16 102JATP	J24185102		1-	A	A2
R 4244	CHIP RES.	1k	1/16W	5%	RMC1/16 102JATP	J24185102		1-	A	H1
R 4245	CHIP RES.	47	1/16W	5%	RMC1/16 470JATP	J24185470		1-	A	E1
R 4246	CHIP RES.	470	1/16W	5%	RMC1/16 471JATP	J24185471		1-	A	E1
R 4247	CHIP RES.	47	1/16W	5%	RMC1/16 470JATP	J24185470		1-	A	H1
R 4248	CHIP RES.	1k	1/16W	5%	RMC1/16 102JATP	J24185102		1-	A	H2
R 4251	CHIP RES.	82k	1/16W	5%	RMC1/16 823JATP	J24185823		1-	A	B2
R 4252	CHIP RES.	27k	1/16W	5%	RMC1/16 273JATP	J24185273		1-	A	H1
R 4254	CHIP RES.	1k	1/16W	5%	RMC1/16 102JATP	J24185102		1-	A	A2
R 4255	CHIP RES.	390	1/16W	5%	RMC1/16 391JATP	J24185391		1-	A	H1
R 4256	CHIP RES.	47	1/16W	5%	RMC1/16 470JATP	J24185470		1-	A	B2
R 4257	CHIP RES.	47	1/16W	5%	RMC1/16 470JATP	J24185470		1-	A	H1
R 4258	CHIP RES.	10	1/16W	5%	RMC1/16 100JATP	J24185100		1-	A	A1
R 4259	CHIP RES.	100k	1/16W	5%	RMC1/16 104JATP	J24185104		1-	A	D3
R 4260	CHIP RES.	100k	1/16W	5%	RMC1/16 104JATP	J24185104		1-	A	G3
R 4261	CHIP RES.	10k	1/16W	5%	RMC1/16 103JATP	J24185103		1-	A	D1
R 4262	CHIP RES.	47	1/16W	5%	RMC1/16 470JATP	J24185470		1-	A	G1
R 4263	CHIP RES.	47	1/16W	5%	RMC1/16 470JATP	J24185470		1-	A	G1
R 4264	CHIP RES.	47	1/16W	5%	RMC1/16 470JATP	J24185470		1-	A	G1
R 4265	CHIP RES.	0	1/16W	5%	RMC1/16 000JATP	J24185000		1-	A	G1
R 4266	CHIP RES.	390	1/16W	5%	RMC1/16 391JATP	J24185391		1-	A	G1
R 4267	CHIP RES.	47	1/16W	5%	RMC1/16 470JATP	J24185470		1-	A	G1
R 4268	CHIP RES.	22k	1/16W	5%	RMC1/16 223JATP	J24185223		1-	A	G1

LOCAL Unit

Parts List

REF	DESCRIPTION	VALUE	V/W	TOL.	MFR'S DESIG	VXSTD P/N	VERS.	LOT	SIDE	LAY ADR
R 4269	CHIP RES.	6.8k	1/16W	5%	RMC1/16 682JATP	J24185682		1-	A	H1
R 4270	CHIP RES.	220	1/16W	5%	RMC1/16 221JATP	J24185221		1-	A	G1
R 4271	CHIP RES.	100k	1/16W	5%	RMC1/16 104JATP	J24185104		1-	A	G1
R 4272	CHIP RES.	220	1/16W	5%	RMC1/16 221JATP	J24185221		1-	A	G1
R 4273	CHIP RES.	0	1/16W	5%	RMC1/16 000JATP	J24185000		1-	A	B1
R 4274	CHIP RES.	1k	1/16W	5%	RMC1/16 102JATP	J24185102		1-	A	E2
R 4275	CHIP RES.	100	1/16W	5%	RMC1/16 101JATP	J24185101		1-	A	H1
R 4276	CHIP RES.	100	1/16W	5%	RMC1/16 101JATP	J24185101		1-	A	H1
R 4277	CHIP RES.	150	1/16W	5%	RMC1/16 151JATP	J24185151		1-	A	H1
R 4281	CHIP RES.	470	1/16W	5%	RMC1/16 471JATP	J24185471		1-	A	E1
R 4282	CHIP RES.	470	1/16W	5%	RMC1/16 471JATP	J24185471		3-		
R 4283	CHIP RES.	470	1/16W	5%	RMC1/16 471JATP	J24185471		3-		
T 4001	BALUN TRANSFORMERS				#458PT-1565	L0190273		1-	A	C1
T 4002	BALUN TRANSFORMERS				#458PT-1565	L0190273		1-	A	F1
T 4003	COIL 05RF				74.62M 010812302	L0022781		1-	A	A1
T 4004	COIL 05RF				74.62M 010812302	L0022781		1-	A	A2
TC4001	TRIMMER CAP.	6pF			ECR-JA006A11X	K91000251		1-	A	B3
TC4002	TRIMMER CAP.	6pF			ECR-JA006A11X	K91000251		1-	A	C3
TC4003	TRIMMER CAP.	6pF			ECR-JA006A11X	K91000251		1-	A	C3
TC4004	TRIMMER CAP.	6pF			ECR-JA006A11X	K91000251		1-	A	D3
TC4005	TRIMMER CAP.	6pF			ECR-JA006A11X	K91000251		1-	A	F3
TC4006	TRIMMER CAP.	6pF			ECR-JA006A11X	K91000251		1-	A	F3
TC4007	TRIMMER CAP.	6pF			ECR-JA006A11X	K91000251		1-	A	G3
TC4008	TRIMMER CAP.	6pF			ECR-JA006A11X	K91000251		1-	A	G3
TP4003	CHECK TERMINAL				RCT00000C	Q5000103		1-	A	E3
TP4004	CHECK TERMINAL				RCT00000C	Q5000103		1-	A	H3
TP4039	CHECK TERMINAL				RCT00000C	Q5000103		1-	A	A1
X 4001	TCXO	34.5MHz			TTS14VSB-A11 34.500MHZ	H9500970		1-	A	A1
	SHIELD CASE				(39X73)	RA0830100		1-		
	SHIELD CASE COVER				(39X73)	RA0830200		1-		

Provided by
 YAESU museum

 Downloaded by
 RadioAmateur.EU

RX-2-UNIT (4501 - 4999)

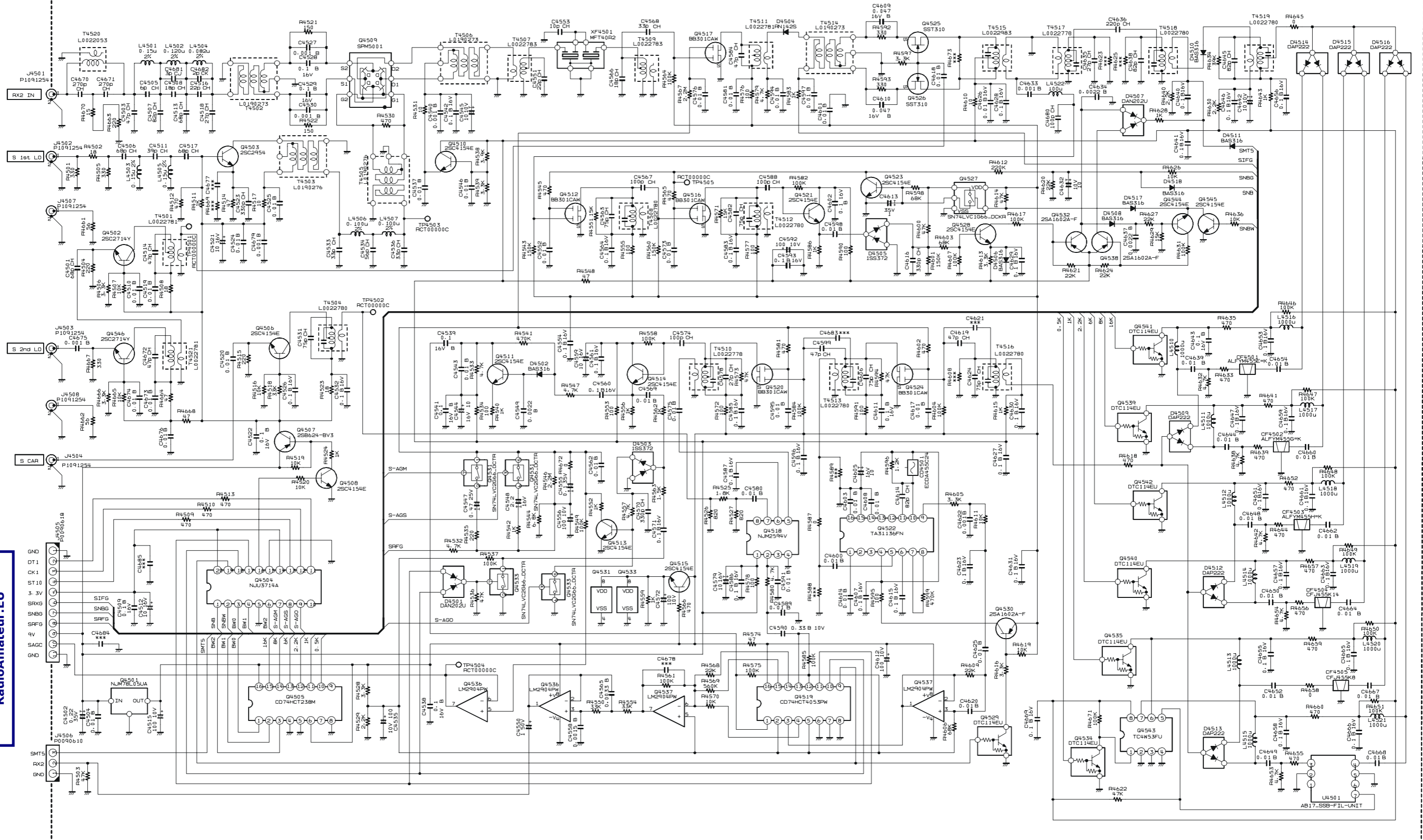

Provided by YAESU museum
Downloaded by RadioAmateur.EU

RX-2 Unit (Lot. 1~4)

Note

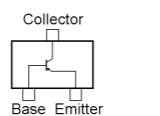
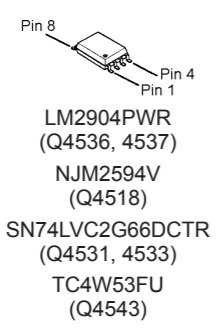
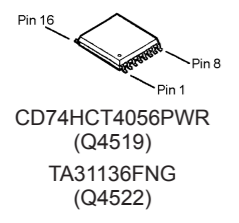
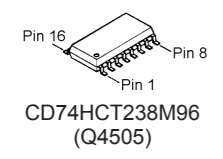
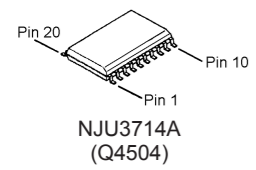
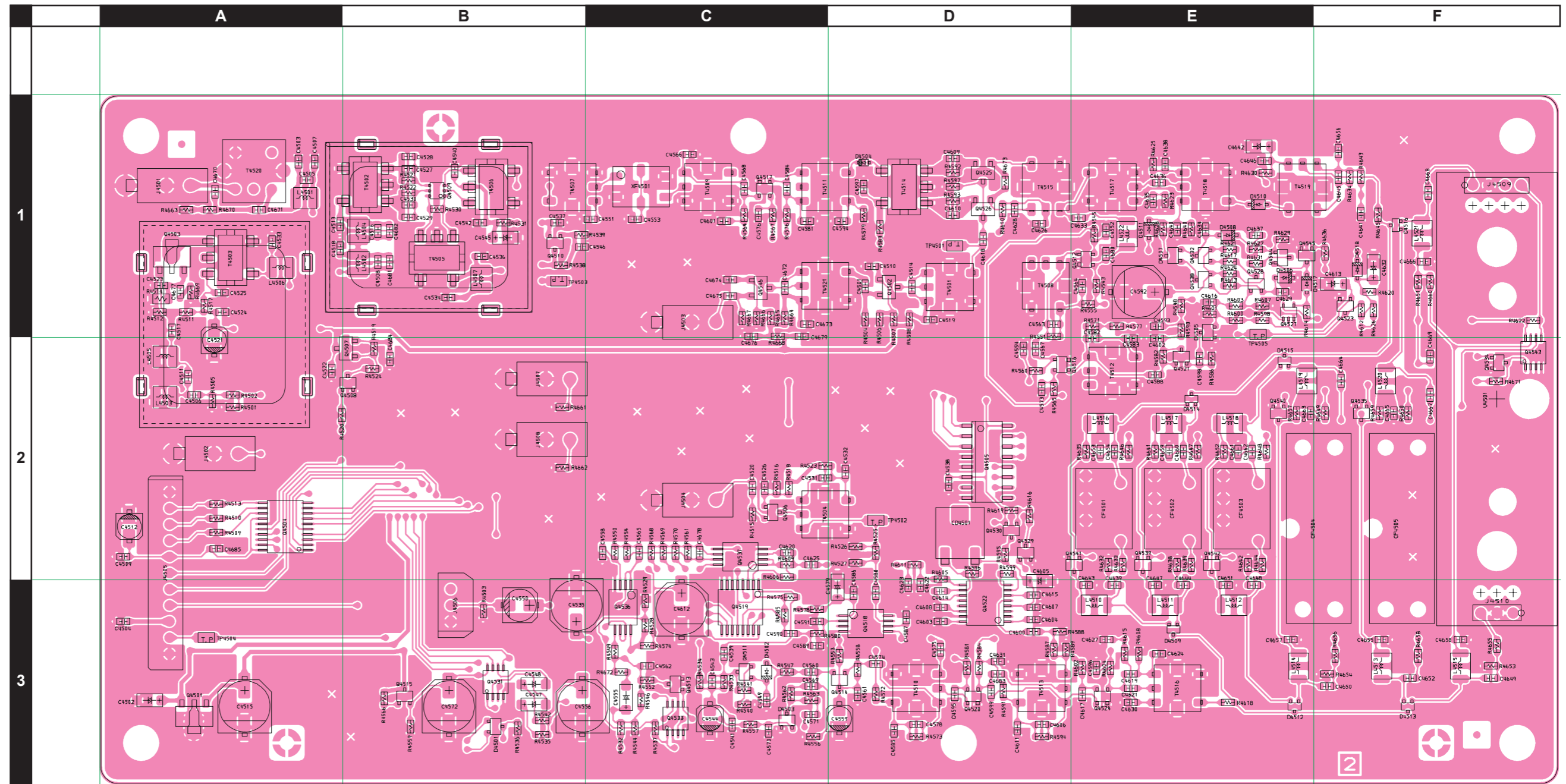

2SA1602A (MF) (Q4502, 4548)
2SB624 (BV3) (Q4507)

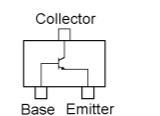

2SC2714 (QY) (Q4502, 4546)
2SC4154 (E) (Q4506, 4508, 4510, 4511, 4513, 4514, 4515, 4521, 4523, 4528, 4544, 4545)

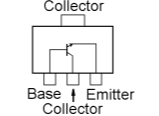

2SC2954 (QK) (Q4503)

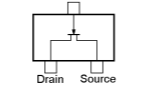

SST310 (Z0) (Q4525, 4526)

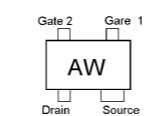

BB301CAW (AW) (Q4512, 4516, 4517, 4520, 4524)

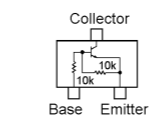

DTC114EUA (24) (Q4529, 4534, 4535, 4539, 4540, 4541, 4542)

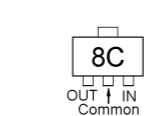

NJM78L05UA (8C) (Q4501)

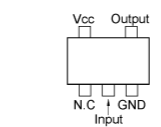

SN74LVC1G66DCKR (Q4527)

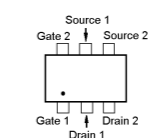

SPM5001 (Q4509)

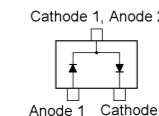

1SS372 (N9) (D4503, 4505)

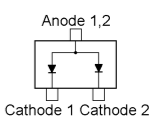

DAP222 (P) (D4509, 4512, 4513, 4514, 4515, 4516)

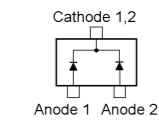

DAN202U (N) (D4501, 4507)

RX-2 Unit (Lot. 1~4)

Parts Layout (Side B)

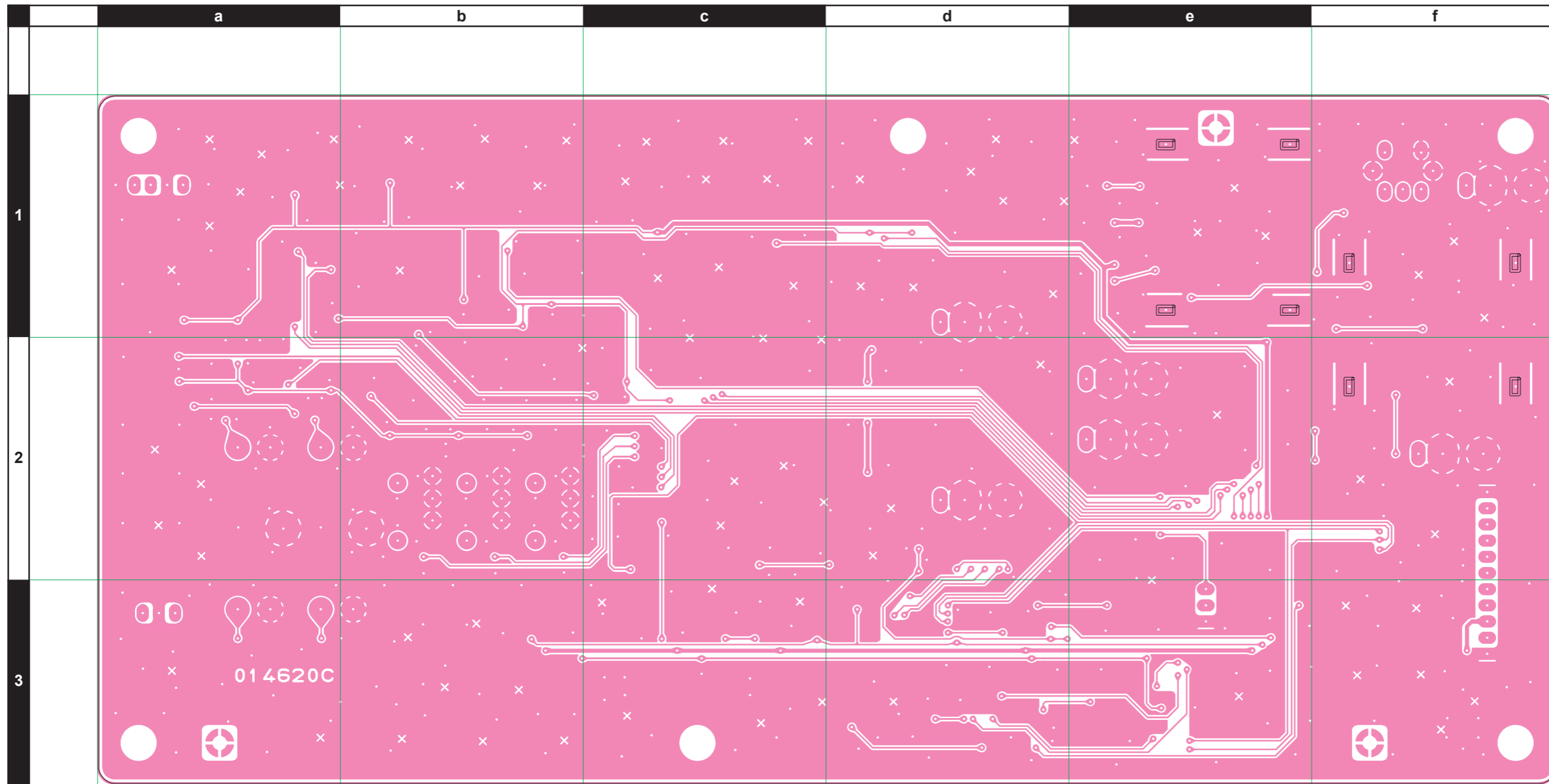

RX-2 Unit (Lot. 5~)

Note

RX-2 Unit

Parts List

REF	DESCRIPTION	VALUE	V/W	TOL.	MFR'S DESIG	VXSTD P/N	VERS.	LOT	SIDE	LAY ADR
PCB with Components						CB3486001				
Printed Circuit Board						AH025H000	FR014620C FR014620D		1- 5-	
C 4501	CHIP CAP.	470pF	50V	CH	GRM1882C1H471JA01D	K22174249		1-	A	D1
C 4502	CHIP TA.CAP.	0.22uF	35V		TESVA1V224M1-8R	K78160027		1-	A	A3
C 4503	CHIP CAP.	47pF	50V	CH	GRM1882C1H470JA01D	K22174227		1-	A	A1
C 4504	CHIP CAP.	0.01uF	50V	B	GRM188B11H103KA01D	K22174823		1-	A	A3
C 4505	CHIP CAP.	6pF	50V	CH	GRM1882C1H6R0DZ01D	K22174207		1-	A	A1
C 4506	CHIP CAP.	68pF	50V	CH	GRM1882C1H680JA01D	K22174231		1-	A	A2
C 4507	CHIP CAP.	82pF	50V	CH	GRM1882C1H820JA01D	K22174233		1-	A	A1
C 4508	CHIP CAP.	18pF	50V	CH	GRM1882C1H180JA01D	K22174217		1-	A	B1
C 4509	CHIP CAP.	0.1uF	16V	B	GRM188B11C104KA01D	K22124805		1-	A	A2
C 4510	CHIP CAP.	0.01uF	50V	B	GRM188B11H103KA01D	K22174823		1-	A	D1
C 4511	CHIP CAP.	39pF	50V	CH	GRM1882C1H390JA01D	K22174225		1-	A	A2
C 4512	AL.ELECTRO.CAP.	10uF	16V		RV2-16V100MB55U-R	K48120014		1-	A	A2
C 4513	CHIP CAP.	68pF	50V	CH	GRM1882C1H680JA01D	K22174231		1-	A	A1
C 4514	CHIP CAP.	56pF	50V	CH	GRM1882C1H560JA01D	K22174229		1-	A	D1
C 4515	AL.ELECTRO.CAP.	100uF	10V		RVZ-10V101MF55U-R2	K48100008		1-	A	A3
C 4516	CHIP CAP.	22pF	50V	CH	GRM1882C1H220JA01D	K22174219		1-	A	B1
C 4517	CHIP CAP.	68pF	50V	CH	GRM1882C1H680JA01D	K22174231		1-	A	A1
C 4518	CHIP CAP.	27pF	50V	CH	GRM1882C1H270JA01D	K22174221		1-	A	A1
C 4519	CHIP CAP.	0.01uF	50V	B	GRM188B11H103KA01D	K22174823		1-	A	D1
C 4520	CHIP CAP.	0.01uF	50V	B	GRM188B11H103KA01D	K22174823		1-	A	C2
C 4521	AL.ELECTRO.CAP.	10uF	16V		RV2-16V100MB55U-R	K48120014		1-	A	A2
C 4522	CHIP CAP.	0.1uF	16V	B	GRM188B11C104KA01D	K22124805		1-	A	A2
C 4524	CHIP CAP.	0.01uF	50V	B	GRM188B11H103KA01D	K22174823		1-	A	A1
C 4525	CHIP CAP.	0.01uF	50V	B	GRM188B11H103KA01D	K22174823		1-	A	A1
C 4526	CHIP CAP.	0.1uF	16V	B	GRM188B11C104KA01D	K22124805		1-	A	C2
C 4527	CHIP CAP.	0.001uF	50V	B	GRM188B11H102KA01D	K22174821		1-	A	B1
C 4528	CHIP CAP.	0.1uF	16V	B	GRM188B11C104KA01D	K22124805		1-	A	B1
C 4529	CHIP CAP.	0.1uF	16V	B	GRM188B11C104KA01D	K22124805		1-	A	B1
C 4530	CHIP CAP.	0.001uF	50V	B	GRM188B11H102KA01D	K22174821		1-	A	B1
C 4531	CHIP CAP.	75pF	50V	CH	GRM1882C1H750JZ01D	K22174232		1-	A	C2
C 4532	CHIP CAP.	0.1uF	16V	B	GRM188B11C104KA01D	K22124805		1-	A	D2
C 4533	CHIP CAP.	33pF	50V	CH	GRM1882C1H330JA01D	K22174223		1-	A	A1
C 4534	CHIP CAP.	56pF	50V	CH	GRM1882C1H560JA01D	K22174229		1-	A	B1
C 4535	AL.ELECTRO.CAP.	100uF	10V		RVZ-10V101MF55U-R2	K48100008		1-	A	B3
C 4536	CHIP CAP.	33pF	50V	CH	GRM1882C1H330JA01D	K22174223		1-	A	B1
C 4537	CHIP CAP.	0.01uF	50V	B	GRM188B11H103KA01D	K22174823		1-	A	B1
C 4538	CHIP CAP.	0.1uF	16V	B	GRM188B11C104KA01D	K22124805		1-	A	D2
C 4539	CHIP CAP.	0.1uF	16V	B	GRM188B11C104KA01D	K22124805		1-	A	C3
C 4540	CHIP CAP.	0.001uF	50V	B	GRM188B11H102KA01D	K22174821		1-2	A	B1
C 4541	CHIP CAP.	0.1uF	16V	B	GRM188B11C104KA01D	K22124805		1-	A	C3
C 4542	CHIP CAP.	0.1uF	16V	B	GRM188B11C104KA01D	K22124805		1-2	A	B1
C 4543	CHIP CAP.	0.01uF	50V	B	GRM188B11H103KA01D	K22174823		1-	A	C3
C 4544	AL.ELECTRO.CAP.	10uF	16V		RV2-16V100MB55U-R	K48120014		1-	A	C3
C 4545	CHIP TA.CAP.	10uF	10V		TEMSVA1A106M-8R	K78100028		1-	A	B1
C 4546	CHIP CAP.	0.01uF	50V	B	GRM188B11H103KA01D	K22174823		1-	A	B1
C 4547	CHIP TA.CAP.	0.47uF	25V		TESVA1E474M1-8R	K78140009		1-	A	B3
C 4548	CHIP TA.CAP.	2.2uF	16V		TEMSVA1C225M-8R	K78120015		1-	A	B3
C 4549	CHIP CAP.	0.0022uF	50V	B	GRM188B11H222KA01D	K22174822		1-	A	C3
C 4550	AL.ELECTRO.CAP.	1uF	50V		EEE1HA010SR	K48170027		1-	A	B3
C 4551	CHIP CAP.	22pF	50V	CH	GRM1882C1H220JA01D	K22174219		1-	A	C1
C 4552	CHIP CAP.	0.01uF	50V	B	GRM188B11H103KA01D	K22174823		1-	A	E1
C 4553	CHIP CAP.	10pF	50V	CH	GRM1882C1H100JA01D	K22174211		1-	A	C1
C 4554	CHIP CAP.	0.1uF	16V	B	GRM188B11C104KA01D	K22124805		1-	A	D2
C 4555	CHIP TA.CAP.	0.1uF	35V		TESVA1V104M1-8R	K78160025		1-	A	C3
C 4556	AL.ELECTRO.CAP.	100uF	10V		RVZ-10V101MF55U-R2	K48100008		1-	A	B3
C 4558	CHIP CAP.	0.0015uF	50V	B	GRM188B11H152KA01D	K22174827		1-	A	C2
C 4559	AL.ELECTRO.CAP.	10uF	16V		RV2-16V100MB55U-R	K48120014		1-	A	D3
C 4560	CHIP CAP.	0.1uF	16V	B	GRM188B11C104KA01D	K22124805		1-	A	C3
C 4561	CHIP CAP.	0.1uF	16V	B	GRM188B11C104KA01D	K22124805		1-	A	D3
C 4562	CHIP CAP.	0.01uF	50V	B	GRM188B11H103KA01D	K22174823		1-	A	C3
C 4563	CHIP CAP.	75pF	50V	CH	GRM1882C1H750JZ01D	K22174232		1-	A	D1
C 4564	CHIP CAP.	0.1uF	16V	B	GRM188B11C104KA01D	K22124805		1-	A	E1
C 4565	CHIP CAP.	0.0033uF	50V	B	GRM188B11H332KA01D	K22174831		1-	A	C2
C 4566	CHIP CAP.	18pF	50V	CH	GRM1882C1H180JA01D	K22174217		1-	A	C1
C 4567	CHIP CAP.	100pF	50V	CH	GRM1882C1H101JA01D	K22174235		1-	A	D2
C 4568	CHIP CAP.	33pF	50V	CH	GRM1882C1H330JA01D	K22174223		1-	A	C1
C 4569	CHIP CAP.	0.01uF	50V	B	GRM188B11H103KA01D	K22174823		1-	A	C3
C 4570	CHIP CAP.	330pF	50V	CH	GRM1882C1H331JA01D	K22174253		1-	A	C3
C 4571	CHIP CAP.	0.1uF	16V	B	GRM188B11C104KA01D	K22124805		1-	A	C3
C 4572	AL.ELECTRO.CAP.	100uF	10V		RVZ-10V101MF55U-R2	K48100008		1-	A	B3

RX-2 Unit

Parts List

REF	DESCRIPTION	VALUE	V/W	TOL.	MFR'S DESIG	VXSTD P/N	VERS.	LOT	SIDE	LAY ADR
C 4573	CHIP CAP.	0.01uF	50V	B	GRM188B11H103KA01D	K22174823		1-	A	D2
C 4574	CHIP CAP.	100pF	50V	CH	GRM1882C1H101JA01D	K22174235		1-	A	D3
C 4575	CHIP CAP.	0.01uF	50V	B	GRM188B11H103KA01D	K22174823		1-	A	D3
C 4576	CHIP CAP.	0.01uF	50V	B	GRM188B11H103KA01D	K22174823		1-	A	C1
C 4578	CHIP CAP.	27pF	50V	CH	GRM1882C1H270JA01D	K22174221		1-	A	D3
C 4579	CHIP TA.CAP.	10uF	16V		TEESVA1C106M8R	K78120077		1-	A	D3
C 4580	CHIP CAP.	0.01uF	50V	B	GRM188B11H103KA01D	K22174823		1-	A	D3
C 4581	CHIP CAP.	0.01uF	50V	B	GRM188B11H103KA01D	K22174823		1-	A	C1
C 4582	CHIP CAP.	75pF	50V	CH	GRM1882C1H750JZ01D	K22174232		1-	A	E2
C 4583	CHIP CAP.	0.1uF	16V	B	GRM188B11C104KA01D	K22124805		1-	A	E2
C 4584	CHIP CAP.	51pF	50V	CH	GRM1882C1H510JZ01D	K22174228		1-	A	C1
C 4585	CHIP CAP.	0.1uF	16V	B	GRM188B11C104KA01D	K22124805		1-	A	D3
C 4586	CHIP CAP.	0.1uF	16V	B	GRM188B11C104KA01D	K22124805		1-	A	D3
C 4587	CHIP CAP.	0.1uF	16V	B	GRM188B11C104KA01D	K22124805		1-	A	D3
C 4588	CHIP CAP.	100pF	50V	CH	GRM1882C1H101JA01D	K22174235		1-	A	E2
C 4589	CHIP CAP.	0.01uF	50V	B	GRM188B11H103KA01D	K22174823		1-	A	C3
C 4590	CHIP CAP.	0.33uF	10V	B	GRM188B11A334KA61D	K22104802		1-	A	C3
C 4591	CHIP CAP.	0.01uF	50V	B	GRM188B11H103KA01D	K22174823		1-	A	C3
C 4592	AL.ELECTRO.CAP.	100uF	10V		RVZ-10V101MF55U-R2	K48100008		1-	A	E1
C 4593	CHIP CAP.	0.1uF	16V	B	GRM188B11C104KA01D	K22124805		1-	A	E1
C 4594	CHIP CAP.	0.01uF	50V	B	GRM188B11H103KA01D	K22174823		1-	A	D1
C 4595	CHIP CAP.	0.01uF	50V	B	GRM188B11H103KA01D	K22174823		1-	A	D3
C 4596	CHIP CAP.	0.1uF	16V	B	GRM188B11C104KA01D	K22124805		1-	A	E3
C 4597	CHIP CAP.	0.01uF	50V	B	GRM188B11H103KA01D	K22174823		1-	A	D1
C 4598	CHIP CAP.	0.01uF	50V	B	GRM188B11H103KA01D	K22174823		1-	A	E2
C 4599	CHIP CAP.	47pF	50V	CH	GRM1882C1H470JA01D	K22174227		1-	A	D3
C 4600	CHIP CAP.	0.01uF	50V	B	GRM188B11H103KA01D	K22174823		1-	A	D3
C 4601	CHIP CAP.	0.01uF	50V	B	GRM188B11H103KA01D	K22174823		1-	A	C1
C 4602	CHIP CAP.	0.1uF	16V	B	GRM188B11C104KA01D	K22124805		1-	A	E2
C 4603	CHIP CAP.	0.01uF	50V	B	GRM188B11H103KA01D	K22174823		1-	A	D3
C 4604	CHIP CAP.	0.01uF	50V	B	GRM188B11H103KA01D	K22174823		1-	A	D3
C 4605	CHIP TA.CAP.	10uF	16V		TEESVA1C106M8R	K78120077		1-	A	D3
C 4606	CHIP CAP.	75pF	50V	CH	GRM1882C1H750JZ01D	K22174232		1-	A	D3
C 4607	CHIP CAP.	0.1uF	16V	B	GRM188B11C104KA01D	K22124805		1-	A	D3
C 4608	CHIP CAP.	0.01uF	50V	B	GRM188B11H103KA01D	K22174823		1-	A	D3
C 4609	CHIP CAP.	0.047uF	16V	B	GRM39B473K16PT	K22124804		1-	A	D1
C 4610	CHIP CAP.	0.047uF	16V	B	GRM39B473K16PT	K22124804		1-	A	D1
C 4611	CHIP CAP.	0.1uF	16V	B	GRM188B11C104KA01D	K22124805		1-	A	D3
C 4612	AL.ELECTRO.CAP.	100uF	10V		RVZ-10V101MF55U-R2	K48100008		1-	A	C3
C 4613	CHIP TA.CAP.	1uF	35V		TEMSVA1V105M-8R	K78160032		1-	A	F1
C 4614	CHIP CAP.	82pF	50V	CH	GRM1882C1H820JA01D	K22174233		1-	A	D3
C 4615	CHIP CAP.	0.1uF	16V	B	GRM188B11C104KA01D	K22124805		1-	A	D3
C 4616	CHIP CAP.	330pF	50V	CH	GRM1882C1H331JA01D	K22174253		1-	A	E1
C 4617	CHIP CAP.	0.01uF	50V	B	GRM188B11H103KA01D	K22174823		1-	A	E3
C 4618	CHIP CAP.	0.01uF	50V	B	GRM188B11H103KA01D	K22174823		1-	A	D1
C 4619	CHIP CAP.	47pF	50V	CH	GRM1882C1H470JA01D	K22174227		1-	A	E3
C 4620	CHIP CAP.	0.01uF	50V	B	GRM188B11H103KA01D	K22174823		1-	A	C2
C 4622	CHIP CAP.	0.001uF	50V	B	GRM188B11H102KA01D	K22174821		1-	A	D3
C 4623	CHIP CAP.	0.1uF	16V	B	GRM188B11C104KA01D	K22124805		1-	A	D3
C 4624	CHIP CAP.	75pF	50V	CH	GRM1882C1H750JZ01D	K22174232		1-	A	E3
C 4625	CHIP CAP.	0.01uF	50V	B	GRM188B11H103KA01D	K22174823		1-	A	C2
C 4626	CHIP CAP.	0.01uF	16V	B	ECUV1C103KBV	K22129510		1-	A	D1
C 4627	CHIP CAP.	0.1uF	16V	B	GRM188B11C104KA01D	K22124805		1-	A	E3
C 4628	CHIP CAP.	0.1uF	16V	B	GRM188B11C104KA01D	K22124805		1-	A	D1
C 4629	CHIP CAP.	0.1uF	16V	B	GRM188B11C104KA01D	K22124805		1-	A	E1
C 4630	CHIP CAP.	0.1uF	16V	B	GRM188B11C104KA01D	K22124805		1-	A	E3
C 4631	CHIP CAP.	0.1uF	16V	B	GRM188B11C104KA01D	K22124805		1-	A	D3
C 4632	CHIP TA.CAP.	10uF	10V		TEMSVA1A106M-8R	K78100028		1-	A	F1
C 4633	CHIP CAP.	0.001uF	50V	B	GRM188B11H102KA01D	K22174821		1-	A	E1
C 4634	CHIP CAP.	0.0022uF	50V	B	GRM188B11H222KA01D	K22174822		1-	A	E1
C 4635	CHIP CAP.	27pF	50V	CH	GRM1882C1H270JA01D	K22174221		1-	A	E1
C 4636	CHIP CAP.	220pF	50V	CH	GRM1882C1H221JA01D	K22174243		1-	A	E1
C 4637	CHIP CAP.	0.0022uF	50V	B	GRM188B11H222KA01D	K22174822		1-	A	E1
C 4638	CHIP CAP.	82pF	50V	CH	GRM1882C1H820JA01D	K22174233		1-	A	E1
C 4639	CHIP CAP.	0.01uF	50V	B	GRM188B11H103KA01D	K22174823		1-	A	E3
C 4640	CHIP CAP.	0.1uF	16V	B	GRM188B11C104KA01D	K22124805		1-	A	E1
C 4641	CHIP CAP.	0.1uF	16V	B	GRM188B11C104KA01D	K22124805		1-	A	F1
C 4642	CHIP TA.CAP.	10uF	10V		TEMSVA1A106M-8R	K78100028		1-	A	E1
C 4643	CHIP CAP.	0.1uF	16V	B	GRM188B11C104KA01D	K22124805		1-	A	E3
C 4644	CHIP CAP.	0.01uF	50V	B	GRM188B11H103KA01D	K22174823		1-	A	E3
C 4645	CHIP CAP.	100pF	50V	CH	GRM1882C1H101JA01D	K22174235		1-	A	F1
C 4646	CHIP CAP.	0.1uF	16V	B	GRM188B11C104KA01D	K22124805		1-	A	E1
C 4647	CHIP CAP.	0.1uF	16V	B	GRM188B11C104KA01D	K22124805		1-	A	E3

RX-2 Unit

Parts List

REF	DESCRIPTION	VALUE	V/W	TOL.	MFR'S DESIG	VXSTD P/N	VERS.	LOT	SIDE	LAY ADR
C 4648	CHIP CAP.	0.01uF	50V	B	GRM188B11H103KA01D	K22174823		1-	A	E3
C 4649	CHIP CAP.	0.01uF	50V	B	GRM188B11H103KA01D	K22174823		1-	A	F3
C 4650	CHIP CAP.	0.01uF	50V	B	GRM188B11H103KA01D	K22174823		1-	A	F3
C 4651	CHIP CAP.	0.1uF	16V	B	GRM188B11C104KA01D	K22124805		1-	A	E3
C 4652	CHIP CAP.	0.01uF	50V	B	GRM188B11H103KA01D	K22174823		1-	A	F3
C 4653	CHIP CAP.	0.1uF	16V	B	GRM188B11C104KA01D	K22124805		1-	A	E2
C 4654	CHIP CAP.	0.01uF	50V	B	GRM188B11H103KA01D	K22174823		1-	A	E2
C 4655	CHIP CAP.	0.1uF	16V	B	GRM188B11C104KA01D	K22124805		1-	A	F3
C 4656	CHIP CAP.	0.1uF	16V	B	GRM188B11C104KA01D	K22124805		1-	A	F1
C 4657	CHIP CAP.	0.1uF	16V	B	GRM188B11C104KA01D	K22124805		1-	A	E3
C 4658	CHIP CAP.	0.1uF	16V	B	GRM188B11C104KA01D	K22124805		1-	A	F3
C 4659	CHIP CAP.	0.1uF	16V	B	GRM188B11C104KA01D	K22124805		1-	A	E2
C 4660	CHIP CAP.	0.01uF	50V	B	GRM188B11H103KA01D	K22174823		1-	A	E2
C 4661	CHIP CAP.	0.1uF	16V	B	GRM188B11C104KA01D	K22124805		1-	A	E2
C 4662	CHIP CAP.	0.01uF	50V	B	GRM188B11H103KA01D	K22174823		1-	A	E2
C 4663	CHIP CAP.	0.1uF	16V	B	GRM188B11C104KA01D	K22124805		1-	A	E2
C 4664	CHIP CAP.	0.01uF	50V	B	GRM188B11H103KA01D	K22174823		1-	A	F2
C 4665	CHIP CAP.	0.1uF	16V	B	GRM188B11C104KA01D	K22124805		1-	A	F2
C 4666	CHIP CAP.	0.1uF	16V	B	GRM188B11C104KA01D	K22124805		1-	A	F1
C 4667	CHIP CAP.	0.01uF	50V	B	GRM188B11H103KA01D	K22174823		1-	A	F2
C 4668	CHIP CAP.	0.01uF	50V	B	GRM188B11H103KA01D	K22174823		1-	A	F1
C 4669	CHIP CAP.	0.1uF	16V	B	GRM188B11C104KA01D	K22124805		1-	A	F2
C 4670	CHIP CAP.	330pF	50V	CH	GRM1882C1H331JA01D	K22174253		1-	A	A1
C 4671	CHIP CAP.	330pF	50V	CH	GRM1882C1H331JA01D	K22174253		1-	A	A1
C 4672	CHIP CAP.	56pF	50V	CH	GRM1882C1H560JA01D	K22174229		1-	A	C1
C 4673	CHIP CAP.	0.01uF	50V	B	GRM188B11H103KA01D	K22174823		1-	A	C1
C 4674	CHIP CAP.	0.01uF	50V	B	GRM188B11H103KA01D	K22174823		1-	A	C1
C 4675	CHIP CAP.	0.001uF	50V	B	GRM188B11H102KA01D	K22174821		1-	A	C1
C 4676	CHIP CAP.	0.01uF	50V	B	GRM188B11H103KA01D	K22174823		1-	A	C1
C 4679	CHIP CAP.	0.001uF	50V	B	GRM188B11H102KA01D	K22174821		1-	A	C1
C 4680	CHIP CAP.	100pF	50V	CH	GRM1882C1H101JA01D	K22174235		1-	A	E1
C 4681	CHIP CAP.	3pF	50V	CJ	GRM1883C1H3R0CZ01D	K22174204		1-	A	B1
C 4682	CHIP CAP.	2pF	50V	CK	GRM1884C1H2R0CZ01D	K22174203		1-	A	B1
C 4686	CHIP CAP.	22pF	50V	CH	GRM1882C1H220JA01D	K22174219		3-		
C 4687	CHIP CAP.	22pF	50V	CH	GRM1882C1H220JA01D	K22174219		3-		
CD4501	CERAMIC DISC				ECDA455C24	H7901470		1-	A	D2
CF4501	CERAMIC FILTER				ALFYM455E=K	H3900543		1-	A	E2
CF4502	CERAMIC FILTER				ALFYM455G=K	H3900545		1-	A	E2
CF4503	CERAMIC FILTER				ALFYM455H=K	H3900542		1-	A	E2
CF4504	CERAMIC FILTER				CFJ455K14	H3900386		1-	A	F3
CF4505	CERAMIC FILTER				CFJ455K8	H3900553		1-	A	F3
D 4501	DIODE				DAN202U T106	G2070162		1-	A	B3
D 4502	DIODE				BAS316	G2070716		1-	A	C3
D 4503	DIODE				1SS372(TE85R.F)	G2070632		1-	A	C3
D 4504	DIODE				RN142S TE61	G2070994		1-	A	D1
D 4505	DIODE				1SS372(TE85R.F)	G2070632		1-	A	E1
D 4506	DIODE				BAS316	G2070716		1-	A	E1
D 4507	DIODE				DAN202U T106	G2070162		1-	A	E1
D 4508	DIODE				BAS316	G2070716		1-	A	E1
D 4509	DIODE				DAP222-TL	G2070432		1-	A	E3
D 4510	DIODE				BAS316	G2070716		1-	A	E1
D 4512	DIODE				DAP222-TL	G2070432		1-	A	E3
D 4513	DIODE				DAP222-TL	G2070432		1-	A	F3
D 4514	DIODE				DAP222-TL	G2070432		1-	A	E2
D 4515	DIODE				DAP222-TL	G2070432		1-	A	E2
D 4516	DIODE				DAP222-TL	G2070432		1-	A	F1
D 4517	DIODE				BAS316	G2070716		1-	A	E1
D 4518	DIODE				BAS316	G2070716		1-	A	F1
J 4501	CONNECTOR				TMP-S01X-C1	P1091254		1-	A	A1
J 4502	CONNECTOR				TMP-S01X-C1	P1091254		1-	A	A2
J 4503	CONNECTOR				TMP-S01X-C1	P1091254		1-	A	C1
J 4504	CONNECTOR				TMP-S01X-C1	P1091254		1-	A	C2
J 4505	CONNECTOR				SB20-11WS	P0090618		1-	A	A2
J 4506	CONNECTOR				SB20-03WS	P0090610		1-	A	B3
J 4507	CONNECTOR				TMP-S01X-C1	P1091254		1-	A	B2
J 4508	CONNECTOR				TMP-S01X-C1	P1091254		1-	A	B2
J 4509	CONNECTOR				9210B-1-03Z172-T	P0091282		1-		
J 4510	CONNECTOR				9210B-1-04Z172-T	P0091283		1-		
L 4501	CHIP COIL	0.15uH		2%	C2520C-R15G	L1691296		1-	A	A1
L 4502	CHIP COIL	0.12uH		2%	C2520C-R12G	L1691295		1-	A	B1
L 4503	CHIP COIL	0.15uH		2%	C2520C-R15G	L1691296		1-	A	A2
L 4504	CHIP COIL	0.082uH		2%	C2520C-82NG	L1691293		1-	A	B1
L 4505	CHIP COIL	0.15uH		2%	C2520C-R15G	L1691296		1-	A	A2

RX-2 Unit

Parts List

REF	DESCRIPTION	VALUE	V/W	TOL.	MFR'S DESIG	VXSTD P/N	VERS.	LOT	SIDE	LAY ADR
L 4506	CHIP COIL	0.1uH		2%	C2520C-R10G	L1691294		1-	A	A1
L 4507	CHIP COIL	0.1uH		2%	C2520C-R10G	L1691294		1-	A	B1
L 4510	M.RFC	1000uH			LLM3225-102J	L1691157		1-	A	E3
L 4511	M.RFC	1000uH			LLM3225-102J	L1691157		1-	A	E3
L 4512	M.RFC	1000uH			LLM3225-102J	L1691157		1-	A	E3
L 4513	M.RFC	1000uH			LLM3225-102J	L1691157		1-	A	F3
L 4514	M.RFC	1000uH			LLM3225-102J	L1691157		1-	A	E3
L 4515	M.RFC	1000uH			LLM3225-102J	L1691157		1-	A	F3
L 4516	M.RFC	1000uH			LLM3225-102J	L1691157		1-	A	E2
L 4517	M.RFC	1000uH			LLM3225-102J	L1691157		1-	A	E2
L 4518	M.RFC	1000uH			LLM3225-102J	L1691157		1-	A	E2
L 4519	M.RFC	1000uH			LLM3225-102J	L1691157		1-	A	E2
L 4520	M.RFC	1000uH			LLM3225-102J	L1691157		1-	A	F2
L 4521	M.RFC	1000uH			LLM3225-102J	L1691157		1-	A	F1
L 4522	M.RFC	100uH			LLM3225-101J	L1691145		1-	A	E1
Q 4501	IC				NJM78L05UA-TE1	G1091325		1-	A	A3
Q 4502	TRANSISTOR				2SC2714Y(TE85R.F)	G3327147Y		1-	A	D1
Q 4503	TRANSISTOR				2SC2954-T2	G3329547		1-	A	A1
Q 4504	IC				NJU3714A(TAPE)	G1094291		1-	A	A2
Q 4505	IC				CD74HCT238M96	G1093850		1-	A	D2
Q 4506	TRANSISTOR				2SC4154-T11-1E	G3341548E		1-	A	C2
Q 4507	TRANSISTOR				2SB624-T2B BV3	G3206247C		1-	A	B2
Q 4508	TRANSISTOR				2SC4154-T11-1E	G3341548E		1-	A	B2
Q 4509	IC				SPM5001-TL-E	G1093686		1-	A	B1
Q 4510	TRANSISTOR				2SC4154-T11-1E	G3341548E		1-	A	B1
Q 4511	TRANSISTOR				2SC4154-T11-1E	G3341548E		1-	A	C3
Q 4512	IC				BB301CAW-TL	G1093186		1-	A	E1
Q 4513	TRANSISTOR				2SC4154-T11-1E	G3341548E		1-	A	C3
Q 4514	TRANSISTOR				2SC4154-T11-1E	G3341548E		1-	A	D3
Q 4515	TRANSISTOR				2SC4154-T11-1E	G3341548E		1-	A	B3
Q 4516	IC				BB301CAW-TL	G1093186		1-	A	D2
Q 4517	IC				BB301CAW-TL	G1093186		1-	A	C1
Q 4518	IC				NJM2594V-TE1	G1093750		1-	A	D3
Q 4519	IC				CD74HCT4053PWR	G1094273		1-	A	C3
Q 4520	IC				BB301CAW-TL	G1093186		1-	A	D3
Q 4521	TRANSISTOR				2SC4154-T11-1E	G3341548E		1-	A	E2
Q 4522	IC				TA31136FNG(EL)	G1091605		1-	A	D3
Q 4523	TRANSISTOR				2SC4154-T11-1E	G3341548E		1-	A	F1
Q 4524	IC				BB301CAW-TL	G1093186		1-	A	E3
Q 4525	FET				SST310-T1	G4070009		1-	A	D1
Q 4526	FET				SST310-T1	G4070009		1-	A	D1
Q 4527	IC				SN74LVC1G66DCKR	G1094046		1-	A	E1
Q 4528	TRANSISTOR				2SC4154-T11-1E	G3341548E		1-	A	E1
Q 4529	TRANSISTOR				DTC114EUA T106	G3070084		1-	A	D2
Q 4530	TRANSISTOR				2SA1602A-T11-1F	G3116028F		1-	A	D2
Q 4531	IC				SN74LVC2G66DCTR	G1094049		1-	A	B3
Q 4532	TRANSISTOR				2SA1602A-T11-1F	G3116028F		1-	A	E1
Q 4533	IC				SN74LVC2G66DCTR	G1094049		1-	A	C3
Q 4534	TRANSISTOR				DTC114EUA T106	G3070084		1-	A	F2
Q 4535	TRANSISTOR				DTC114EUA T106	G3070084		1-	A	F2
Q 4536	IC				LM2904PWR	G1094010		1-	A	C3
Q 4537	IC				LM2904PWR	G1094010		1-	A	C2
Q 4538	TRANSISTOR				2SA1602A-T11-1F	G3116028F		1-	A	E1
Q 4539	TRANSISTOR				DTC114EUA T106	G3070084		1-	A	E2
Q 4540	TRANSISTOR				DTC114EUA T106	G3070084		1-	A	E2
Q 4541	TRANSISTOR				DTC114EUA T106	G3070084		1-	A	E2
Q 4542	TRANSISTOR				DTC114EUA T106	G3070084		1-	A	E2
Q 4543	IC				TC4W53FU(TE12L_F)	G1091675		1-	A	F2
Q 4544	TRANSISTOR				2SC4154-T11-1E	G3341548E		1-	A	E1
Q 4545	TRANSISTOR				2SC4154-T11-1E	G3341548E		1-	A	E1
Q 4546	TRANSISTOR				2SC2714Y(TE85R.F)	G3327147Y		1-	A	C1
R 4501	CHIP RES.	68	1/16W	5%	RMC1/16 680JATP	J24185680		1-	A	A2
R 4501	CHIP RES.	82	1/16W	5%	RMC1/16 820JATP	J24185820		4-	A	A2
R 4502	CHIP RES.	150	1/16W	5%	RMC1/16 151JATP	J24185151		1-	A	A2
R 4502	CHIP RES.	100	1/16W	5%	RMC1/16 101JATP	J24185101		4-	A	A2
R 4503	CHIP RES.	47k	1/16W	5%	RMC1/16 473JATP	J24185473		1-	A	B3
R 4504	CHIP RES.	100	1/16W	5%	RMC1/16 101JATP	J24185101		1-	A	D1
R 4505	CHIP RES.	68	1/16W	5%	RMC1/16 680JATP	J24185680		1-	A	A2
R 4505	CHIP RES.	82	1/16W	5%	RMC1/16 820JATP	J24185820		4-	A	A2
R 4506	CHIP RES.	3.3k	1/16W	5%	RMC1/16 332JATP	J24185332		1-	A	D1
R 4507	CHIP RES.	10k	1/16W	5%	RMC1/16 103JATP	J24185103		1-	A	D1
R 4508	CHIP RES.	18	1/16W	5%	RMC1/16 180JATP	J24185180		1-	A	D1
R 4509	CHIP RES.	470	1/16W	5%	RMC1/16 471JATP	J24185471		1-	A	A2

RX-2 Unit

Parts List

REF	DESCRIPTION	VALUE	V/W	TOL.	MFR'S DESIG	VXSTD P/N	VERS.	LOT	SIDE	LAY ADR
R 4510	CHIP RES.	470	1/16W	5%	RMC1/16 471JATP	J24185471		1-	A	A2
R 4511	CHIP RES.	1k	1/16W	5%	RMC1/16 102JATP	J24185102		1-	A	A1
R 4512	CHIP RES.	470	1/16W	5%	RMC1/16 471JATP	J24185471		1-	A	A1
R 4513	CHIP RES.	470	1/16W	5%	RMC1/16 471JATP	J24185471		1-	A	A2
R 4514	CHIP RES.	47	1/10W	5%	RMC1/10T 470J	J24205470		1-	A	A1
R 4515	CHIP RES.	220	1/16W	5%	RMC1/16 221JATP	J24185221		1-	A	C2
R 4516	CHIP RES.	10k	1/16W	5%	RMC1/16 103JATP	J24185103		1-	A	C2
R 4517	CHIP RES.	10	1/16W	5%	RMC1/16 100JATP	J24185100		1-	A	A1
R 4518	CHIP RES.	33k	1/16W	5%	RMC1/16 333JATP	J24185333		1-	A	C2
R 4519	CHIP RES.	10k	1/16W	5%	RMC1/16 103JATP	J24185103		1-	A	B2
R 4520	CHIP RES.	10k	1/16W	5%	RMC1/16 103JATP	J24185103		1-	A	A2
R 4521	CHIP RES.	150	1/16W	5%	RMC1/16 151JATP	J24185151		1-	A	B1
R 4522	CHIP RES.	150	1/16W	5%	RMC1/16 151JATP	J24185151		1-	A	B1
R 4523	CHIP RES.	18	1/16W	5%	RMC1/16 180JATP	J24185180		1-	A	C2
R 4524	CHIP RES.	1k	1/16W	5%	RMC1/16 102JATP	J24185102		1-	A	B2
R 4525	CHIP RES.	1.8k	1/16W	5%	RMC1/16 182JATP	J24185182		1-	A	D2
R 4526	CHIP RES.	820	1/16W	5%	RMC1/16 821JATP	J24185821		1-	A	D2
R 4527	CHIP RES.	820	1/16W	5%	RMC1/16 821JATP	J24185821		1-	A	D2
R 4528	CHIP RES.	3.3k	1/16W	5%	RMC1/16 332JATP	J24185332		1-	A	C3
R 4529	CHIP RES.	2.2k	1/16W	5%	RMC1/16 222JATP	J24185222		1-	A	C3
R 4530	CHIP RES.	470	1/16W	5%	RMC1/16 471JATP	J24185471		1-	A	B1
R 4531	CHIP RES.	10	1/16W	5%	RMC1/16 100JATP	J24185100		1-	A	B1
R 4532	CHIP RES.	4.7k	1/16W	5%	RMC1/16 472JATP	J24185472		1-	A	C3
R 4533	CHIP RES.	4.7k	1/16W	5%	RMC1/16 472JATP	J24185472		1-	A	C3
R 4534	CHIP RES.	100	1/16W	5%	RMC1/16 101JATP	J24185101		1-	A	C3
R 4535	CHIP RES.	220	1/16W	5%	RMC1/16 221JATP	J24185221		1-	A	B3
R 4536	CHIP RES.	47k	1/16W	5%	RMC1/16 473JATP	J24185473		1-	A	B3
R 4538	CHIP RES.	3.9k	1/16W	5%	RMC1/16 392JATP	J24185392		1-	A	B1
R 4539	CHIP RES.	3.3k	1/16W	5%	RMC1/16 332JATP	J24185332		1-	A	B1
R 4540	CHIP RES.	1k	1/16W	5%	RMC1/16 102JATP	J24185102		1-	A	C3
R 4541	CHIP RES.	470k	1/16W	5%	RMC1/16 474JATP	J24185474		1-	A	C3
R 4542	CHIP RES.	1k	1/16W	5%	RMC1/16 102JATP	J24185102		1-	A	B3
R 4543	CHIP RES.	150k	1/16W	5%	RMC1/16 154JATP	J24185154		1-	A	E1
R 4544	CHIP RES.	6.8k	1/16W	5%	RMC1/16 682JATP	J24185682		1-	A	C3
R 4545	CHIP RES.	470	1/16W	5%	RMC1/16 471JATP	J24185471		1-	A	E1
R 4546	CHIP RES.	2.2M	1/16W	5%	RMC1/16 225JATP	J24185225		1-	A	C3
R 4547	CHIP RES.	4.7k	1/16W	5%	RMC1/16 472JATP	J24185472		1-	A	C3
R 4548	CHIP RES.	47	1/16W	5%	RMC1/16 470JATP	J24185470		1-	A	E1
R 4549	CHIP RES.	100k	1/16W	5%	RMC1/16 104JATP	J24185104		1-	A	C3
R 4550	CHIP RES.	33k	1/16W	5%	RMC1/16 333JATP	J24185333		1-	A	C2
R 4551	CHIP RES.	15k	1/16W	5%	RMC1/16 153JATP	J24185153		1-	A	D1
R 4552	CHIP RES.	1k	1/16W	5%	RMC1/16 102JATP	J24185102		1-	A	C3
R 4553	CHIP RES.	100	1/16W	5%	RMC1/16 101JATP	J24185101		1-	A	D3
R 4554	CHIP RES.	33k	1/16W	5%	RMC1/16 333JATP	J24185333		1-	A	C2
R 4555	CHIP RES.	100	1/16W	5%	RMC1/16 101JATP	J24185101		1-	A	E1
R 4556	CHIP RES.	1k	1/16W	5%	RMC1/16 102JATP	J24185102		1-	A	C3
R 4557	CHIP RES.	4.7k	1/16W	5%	RMC1/16 472JATP	J24185472		1-	A	C3
R 4558	CHIP RES.	100k	1/16W	5%	RMC1/16 104JATP	J24185104		1-	A	D3
R 4559	CHIP RES.	1k	1/16W	5%	RMC1/16 102JATP	J24185102		1-	A	B3
R 4560	CHIP RES.	150k	1/16W	5%	RMC1/16 154JATP	J24185154		1-	A	D2
R 4561	CHIP RES.	120k	1/16W	5%	RMC1/16 124JATP	J24185124		1-	A	C2
R 4562	CHIP RES.	1k	1/16W	5%	RMC1/16 102JATP	J24185102		1-	A	C3
R 4563	CHIP RES.	1.5k	1/16W	5%	RMC1/16 152JATP	J24185152		1-	A	C3
R 4564	CHIP RES.	100k	1/16W	5%	RMC1/16 104JATP	J24185104		1-	A	C1
R 4565	CHIP RES.	470	1/16W	5%	RMC1/16 471JATP	J24185471		1-	A	D2
R 4566	CHIP RES.	470	1/16W	5%	RMC1/16 471JATP	J24185471		1-	A	B3
R 4567	CHIP RES.	2.2M	1/16W	5%	RMC1/16 225JATP	J24185225		1-	A	C1
R 4568	CHIP RES.	22k	1/16W	5%	RMC1/16 223JATP	J24185223		1-	A	C2
R 4569	CHIP RES.	1.2M	1/16W	5%	RMC1/16 125JATP	J24185125		1-	A	C2
R 4570	CHIP RES.	39k	1/16W	5%	RMC1/16 393JATP	J24185393		1-	A	C2
R 4571	CHIP RES.	15k	1/16W	5%	RMC1/16 153JATP	J24185153		1-	A	E1
R 4572	CHIP RES.	100	1/16W	5%	RMC1/16 101JATP	J24185101		1-	A	D3
R 4574	CHIP RES.	47	1/16W	5%	RMC1/16 470JATP	J24185470		1-	A	C3
R 4575	CHIP RES.	100k	1/16W	5%	RMC1/16 104JATP	J24185104		1-	A	C3
R 4576	CHIP RES.	100	1/16W	5%	RMC1/16 101JATP	J24185101		1-	A	C1
R 4577	CHIP RES.	100	1/16W	5%	RMC1/16 101JATP	J24185101		1-	A	E1
R 4578	CHIP RES.	100	1/16W	5%	RMC1/16 101JATP	J24185101		1-	A	C3
R 4579	CHIP RES.	4.7k	1/16W	5%	RMC1/16 472JATP	J24185472		1-	A	D1
R 4580	CHIP RES.	4.7k	1/16W	5%	RMC1/16 472JATP	J24185472		1-	A	C3
R 4581	CHIP RES.	470	1/16W	5%	RMC1/16 471JATP	J24185471		1-	A	D3
R 4582	CHIP RES.	100k	1/16W	5%	RMC1/16 104JATP	J24185104		1-	A	E2
R 4583	CHIP RES.	1k	1/16W	5%	RMC1/16 102JATP	J24185102		1-	A	D1
R 4583	CHIP RES.	15k	1/16W	5%	RMC1/16 153JATP	J24185153		4-	A	D1

RX-2 Unit

Parts List

REF	DESCRIPTION	VALUE	V/W	TOL.	MFR'S DESIG	VXSTD P/N	VERS.	LOT	SIDE	LAY ADR
R 4584	CHIP RES.	100k	1/16W	5%	RMC1/16 104JATP	J24185104		1-	A	D3
R 4585	CHIP RES.	100k	1/16W	5%	RMC1/16 104JATP	J24185104		1-	A	C3
R 4586	CHIP RES.	1k	1/16W	5%	RMC1/16 102JATP	J24185102		1-	A	E2
R 4587	CHIP RES.	0	1/16W	5%	RMC1/16 000JATP	J24185000		1-	A	D3
R 4590	CHIP RES.	100	1/16W	5%	RMC1/16 101JATP	J24185101		1-	A	E1
R 4591	CHIP RES.	100	1/16W	5%	RMC1/16 101JATP	J24185101		1-	A	D3
R 4592	CHIP RES.	330	1/16W	5%	RMC1/16 331JATP	J24185331		1-	A	D1
R 4593	CHIP RES.	330	1/16W	5%	RMC1/16 331JATP	J24185331		1-	A	D1
R 4594	CHIP RES.	47k	1/16W	5%	RMC1/16 473JATP	J24185473		1-	A	D3
R 4595	CHIP RES.	100	1/16W	5%	RMC1/16 101JATP	J24185101		1-	A	D2
R 4596	CHIP RES.	1.2k	1/16W	5%	RMC1/16 122JATP	J24185122		1-	A	D2
R 4597	CHIP RES.	3.3k	1/16W	5%	RMC1/16 332JATP	J24185332		1-	A	D1
R 4598	CHIP RES.	68k	1/16W	5%	RMC1/16 683JATP	J24185683		1-	A	E1
R 4599	CHIP RES.	470k	1/16W	5%	RMC1/16 474JATP	J24185474		1-	A	D2
R 4600	CHIP RES.	47k	1/16W	5%	RMC1/16 473JATP	J24185473		1-	A	E1
R 4601	CHIP RES.	150k	1/16W	5%	RMC1/16 154JATP	J24185154		1-	A	E1
R 4602	CHIP RES.	470	1/16W	5%	RMC1/16 471JATP	J24185471		1-	A	E3
R 4603	CHIP RES.	68k	1/16W	5%	RMC1/16 683JATP	J24185683		1-	A	E1
R 4604	CHIP RES.	100k	1/16W	5%	RMC1/16 104JATP	J24185104		1-	A	E3
R 4605	CHIP RES.	3.3k	1/16W	5%	RMC1/16 332JATP	J24185332		1-	A	D2
R 4606	CHIP RES.	68k	1/16W	5%	RMC1/16 683JATP	J24185683		1-	A	C2
R 4607	CHIP RES.	100k	1/16W	5%	RMC1/16 104JATP	J24185104		1-	A	E1
R 4609	CHIP RES.	22k	1/16W	5%	RMC1/16 223JATP	J24185223		1-	A	C2
R 4610	CHIP RES.	10	1/16W	5%	RMC1/16 100JATP	J24185100		1-	A	D1
R 4611	CHIP RES.	10k	1/16W	5%	RMC1/16 103JATP	J24185103		1-	A	D2
R 4612	CHIP RES.	220k	1/16W	5%	RMC1/16 224JATP	J24185224		1-	A	F1
R 4613	CHIP RES.	3.3k	1/16W	5%	RMC1/16 332JATP	J24185332		1-	A	E1
R 4614	CHIP RES.	47k	1/16W	5%	RMC1/16 473JATP	J24185473		1-	A	E1
R 4615	CHIP RES.	1k	1/16W	5%	RMC1/16 102JATP	J24185102		1-	A	E3
R 4616	CHIP RES.	3.3k	1/16W	5%	RMC1/16 332JATP	J24185332		1-	A	D2
R 4617	CHIP RES.	100k	1/16W	5%	RMC1/16 104JATP	J24185104		1-	A	E1
R 4618	CHIP RES.	470	1/16W	5%	RMC1/16 471JATP	J24185471		1-	A	E3
R 4619	CHIP RES.	10k	1/16W	5%	RMC1/16 103JATP	J24185103		1-	A	D2
R 4620	CHIP RES.	22k	1/16W	5%	RMC1/16 223JATP	J24185223		1-	A	F1
R 4621	CHIP RES.	22k	1/16W	5%	RMC1/16 223JATP	J24185223		1-	A	E1
R 4622	CHIP RES.	47k	1/16W	5%	RMC1/16 473JATP	J24185473		1-	A	F1
R 4624	CHIP RES.	22k	1/16W	5%	RMC1/16 223JATP	J24185223		1-	A	E1
R 4626	CHIP RES.	10k	1/16W	5%	RMC1/16 103JATP	J24185103		1-	A	F1
R 4627	CHIP RES.	22k	1/16W	5%	RMC1/16 223JATP	J24185223		1-	A	E1
R 4628	CHIP RES.	1k	1/16W	5%	RMC1/16 102JATP	J24185102		1-	A	E1
R 4629	CHIP RES.	15k	1/16W	5%	RMC1/16 153JATP	J24185153		1-	A	E1
R 4630	CHIP RES.	2.2k	1/16W	5%	RMC1/16 222JATP	J24185222		1-	A	E1
R 4631	CHIP RES.	100k	1/16W	5%	RMC1/16 104JATP	J24185104		1-	A	E1
R 4632	CHIP RES.	4.7k	1/16W	5%	RMC1/16 472JATP	J24185472		1-	A	E2
R 4633	CHIP RES.	470	1/16W	5%	RMC1/16 471JATP	J24185471		1-	A	E2
R 4634	CHIP RES.	39k	1/16W	5%	RMC1/16 393JATP	J24185393		1-	A	F1
R 4635	CHIP RES.	470	1/16W	5%	RMC1/16 471JATP	J24185471		1-	A	E2
R 4636	CHIP RES.	10k	1/16W	5%	RMC1/16 103JATP	J24185103		1-	A	F1
R 4638	CHIP RES.	4.7k	1/16W	5%	RMC1/16 472JATP	J24185472		1-	A	E2
R 4639	CHIP RES.	470	1/16W	5%	RMC1/16 471JATP	J24185471		1-	A	E2
R 4640	CHIP RES.	2.2k	1/16W	5%	RMC1/16 222JATP	J24185222		1-	A	E1
R 4641	CHIP RES.	470	1/16W	5%	RMC1/16 471JATP	J24185471		1-	A	E2
R 4642	CHIP RES.	4.7k	1/16W	5%	RMC1/16 472JATP	J24185472		1-	A	E2
R 4643	CHIP RES.	1k	1/16W	5%	RMC1/16 102JATP	J24185102		1-	A	F1
R 4644	CHIP RES.	470	1/16W	5%	RMC1/16 471JATP	J24185471		1-	A	E2
R 4645	CHIP RES.	0	1/16W	5%	RMC1/16 000JATP	J24185000		1-	A	F1
R 4646	CHIP RES.	100k	1/16W	5%	RMC1/16 104JATP	J24185104		1-	A	E2
R 4647	CHIP RES.	100k	1/16W	5%	RMC1/16 104JATP	J24185104		1-	A	E2
R 4648	CHIP RES.	100k	1/16W	5%	RMC1/16 104JATP	J24185104		1-	A	E2
R 4649	CHIP RES.	100k	1/16W	5%	RMC1/16 104JATP	J24185104		1-	A	F2
R 4650	CHIP RES.	100k	1/16W	5%	RMC1/16 104JATP	J24185104		1-	A	F2
R 4651	CHIP RES.	100k	1/16W	5%	RMC1/16 104JATP	J24185104		1-	A	F1
R 4652	CHIP RES.	470	1/16W	5%	RMC1/16 471JATP	J24185471		1-	A	E2
R 4653	CHIP RES.	4.7k	1/16W	5%	RMC1/16 472JATP	J24185472		1-	A	F3
R 4654	CHIP RES.	4.7k	1/16W	5%	RMC1/16 472JATP	J24185472		1-	A	F3
R 4655	CHIP RES.	470	1/16W	5%	RMC1/16 471JATP	J24185471		1-	A	F3
R 4656	CHIP RES.	470	1/16W	5%	RMC1/16 471JATP	J24185471		1-	A	F3
R 4657	CHIP RES.	470	1/16W	5%	RMC1/16 471JATP	J24185471		1-	A	E2
R 4658	CHIP RES.	0	1/16W	5%	RMC1/16 000JATP	J24185000		1-	A	F3
R 4659	CHIP RES.	470	1/16W	5%	RMC1/16 471JATP	J24185471		1-	A	F2
R 4660	CHIP RES.	470	1/16W	5%	RMC1/16 471JATP	J24185471		1-	A	F1
R 4661	CHIP RES.	56	1/16W	5%	RMC1/16 560JATP	J24185560		1-	A	B2
R 4662	CHIP RES.	56	1/16W	5%	RMC1/16 560JATP	J24185560		1-	A	B2

RX-2 Unit

Parts List

REF	DESCRIPTION	VALUE	V/W	TOL.	MFR'S DESIG	VXSTD P/N	VERS.	LOT	SIDE	LAY ADR
R 4663	CHIP RES.	150	1/16W	5%	RMC1/16 151JATP	J24185151		1-	A	A1
R 4664	CHIP RES.	47	1/16W	5%	RMC1/16 470JATP	J24185470		1-	A	C1
R 4665	CHIP RES.	10k	1/16W	5%	RMC1/16 103JATP	J24185103		1-	A	C1
R 4666	CHIP RES.	3.3k	1/16W	5%	RMC1/16 332JATP	J24185332		1-	A	C1
R 4667	CHIP RES.	100	1/16W	5%	RMC1/16 101JATP	J24185101		1-	A	C1
R 4668	CHIP RES.	47	1/16W	5%	RMC1/16 470JATP	J24185470		1-	A	C1
R 4670	CHIP RES.	0	1/16W	5%	RMC1/16 000JATP	J24185000		1-	A	A1
R 4671	CHIP RES.	100k	1/16W	5%	RMC1/16 104JATP	J24185104		1-	A	F2
R 4672	CHIP RES.	0	1/16W	5%	RMC1/16 000JATP	J24185000		1-	A	C3
R 4673	CHIP RES.	15k	1/16W	5%	RMC1/16 153JATP	J24185153		4-	A	D1
R 4674	CHIP RES.	0	1/16W	5%	RMC1/16 000JATP	J24185000		1-		
T 4501	COIL 05RF				74.62M 010812302	L0022781		1-	A	D1
T 4502	BALUN TRANSFOMERS				#458PT-1565	L0190273		1-	A	B1
T 4503	BALUN TRANSFOMERS				#458PT-1586	L0190276		1-	A	A1
T 4504	COIL 05RF	455kHz			455K 030812471	L0022780		1-	A	C2
T 4505	BALUN TRANSFOMERS				#458PT-1586	L0190276		1-	A	B1
T 4506	BALUN TRANSFOMERS				#458PT-1565	L0190273		1-	A	B1
T 4507	COIL 05RF				50M 010812304	L0022783		1-	A	B1
T 4508	COIL 05RF	455kHz			455K 030812471	L0022780		1-	A	D1
T 4509	COIL 05RF				50M 010812304	L0022783		1-	A	C1
T 4510	COIL 05RF	455kHz			455K 030812470	L0022778		1-	A	D3
T 4511	COIL 05RF				74.62M 010812302	L0022781		1-	A	C1
T 4512	COIL 05RF	455kHz			455K 030812471	L0022780		1-	A	E2
T 4513	COIL 05RF	455kHz			455K 030812471	L0022780		1-	A	D3
T 4514	BALUN TRANSFOMERS				#458PT-1565	L0190273		1-	A	D1
T 4515	COIL 05RF	455kHz			455K 060812596	L0022983		1-	A	D1
T 4516	COIL 05RF	455kHz			455K 030812471	L0022780		1-	A	E3
T 4517	COIL 05RF	455kHz			455K 030812470	L0022778		1-	A	E1
T 4518	COIL 05RF	455kHz			455K 030812471	L0022780		1-	A	E1
T 4519	COIL 05RF	455kHz			455K 030812471	L0022780		1-	A	E1
T 4520	COIL 07RF	160MHz			160M R12-K905X	L0022053		1-	A	A1
T 4521	COIL 05RF				74.62M 010812302	L0022781		1-	A	C1
TP4501	CHECK TERMINAL				RCT00000C	Q5000103		1-	A	D1
TP4502	CHECK TERMINAL				RCT00000C	Q5000103		1-	A	D2
TP4503	CHECK TERMINAL				RCT00000C	Q5000103		1-	A	B1
TP4504	CHECK TERMINAL				RCT00000C	Q5000103		1-	A	A3
TP4505	CHECK TERMINAL				RCT00000C	Q5000103		1-	A	E1
XF4501	XTAL FILTER				MFT40R2 40.455MHz 15kHz	H1102386		1-	A	C1
	SHIELD CASE				(21X25)	RA0830300		1-		
	SHIELD CASE COVER				(21X25)	RA0830400		1-		

RX-2 Unit

Note:

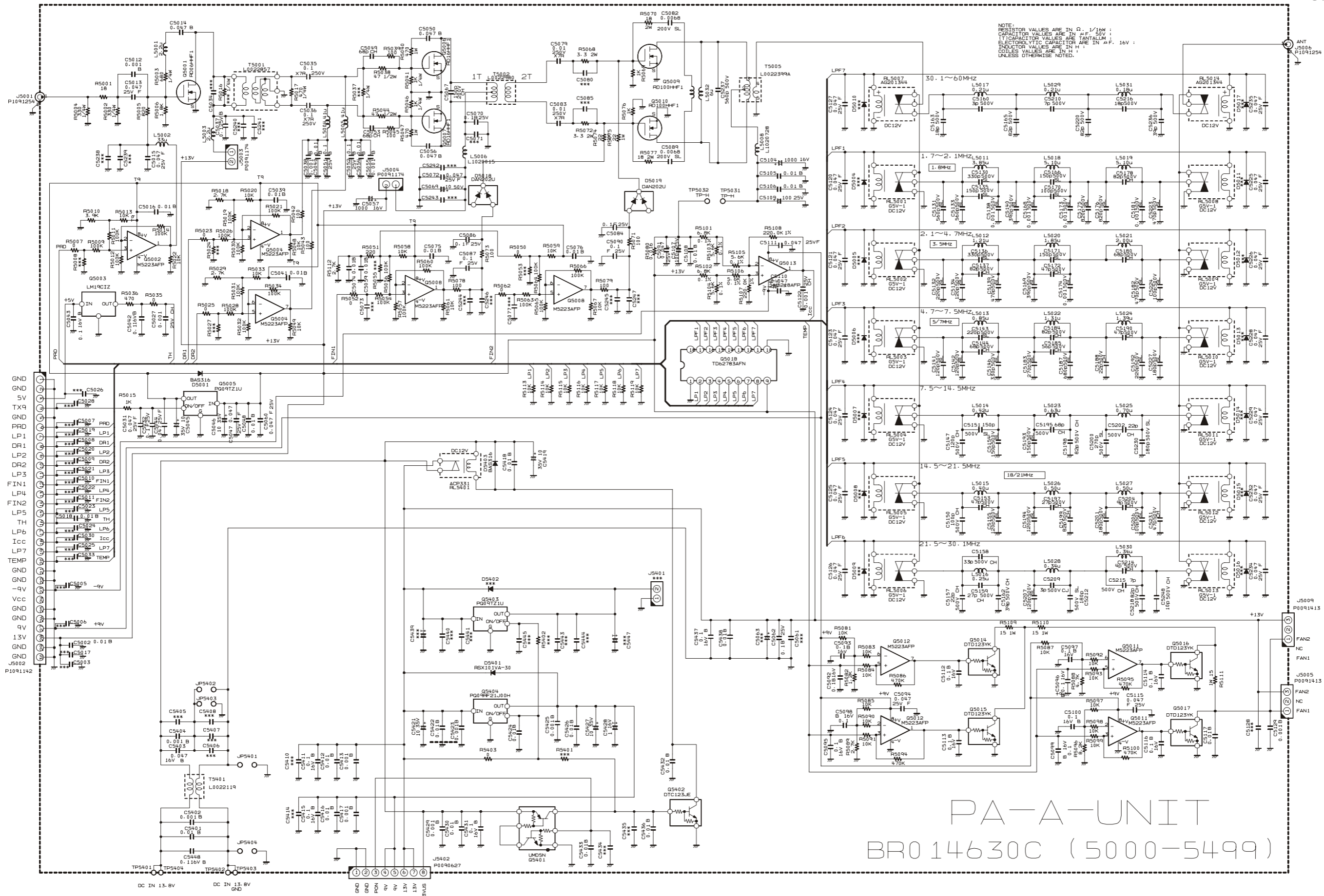

NOTE:
CAPACITOR VALUES ARE IN P.F. 1/16W ;
CAPACITOR VALUES ARE IN P.F. 50V ;
ELECTROLYTIC CAPACITORS ARE IN P.F. 16V ;
INDUCTOR VALUES ARE IN H.H. ;
UNLESS OTHERWISE NOTED.

Provided by
YAESU museum
Downloaded by
RadioAmateur.EU

PA-A-UNIT
BR014630C (5000-5499)

PA-A Unit

Note

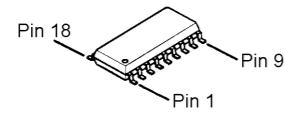

TD62783AFN
(Q5018)

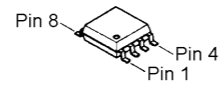

M5223AFP 600C
(Q5002, 5004, 5008,
5011, 5012)

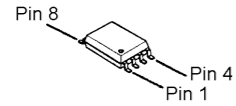

M5218AFP
(Q5013)

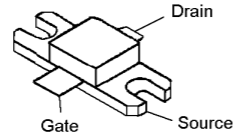

RD100HHF1
(Q5009, 5010)

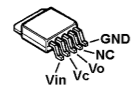

PQ09TZ1U
(Q5005)

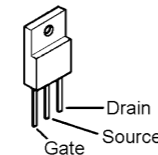

RD06HHF
(Q5001)

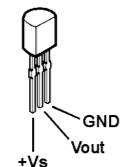

LM19CIZ
(Q5003)

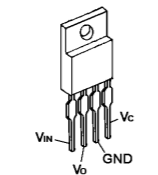

PQ09RF21
(Q5404)

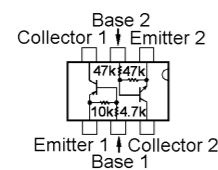

UMD5N
(Q5401)

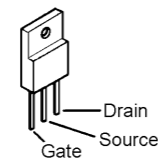

RD16HHF1
(Q5006, 5007)

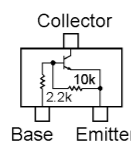

DTD123YK (F62)
(Q5014, 5015, 5016,
5017)

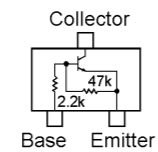

DTC123JE (E42)
(Q5402)

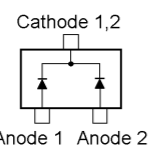

DAN202U (N)
(D5018, 5019)

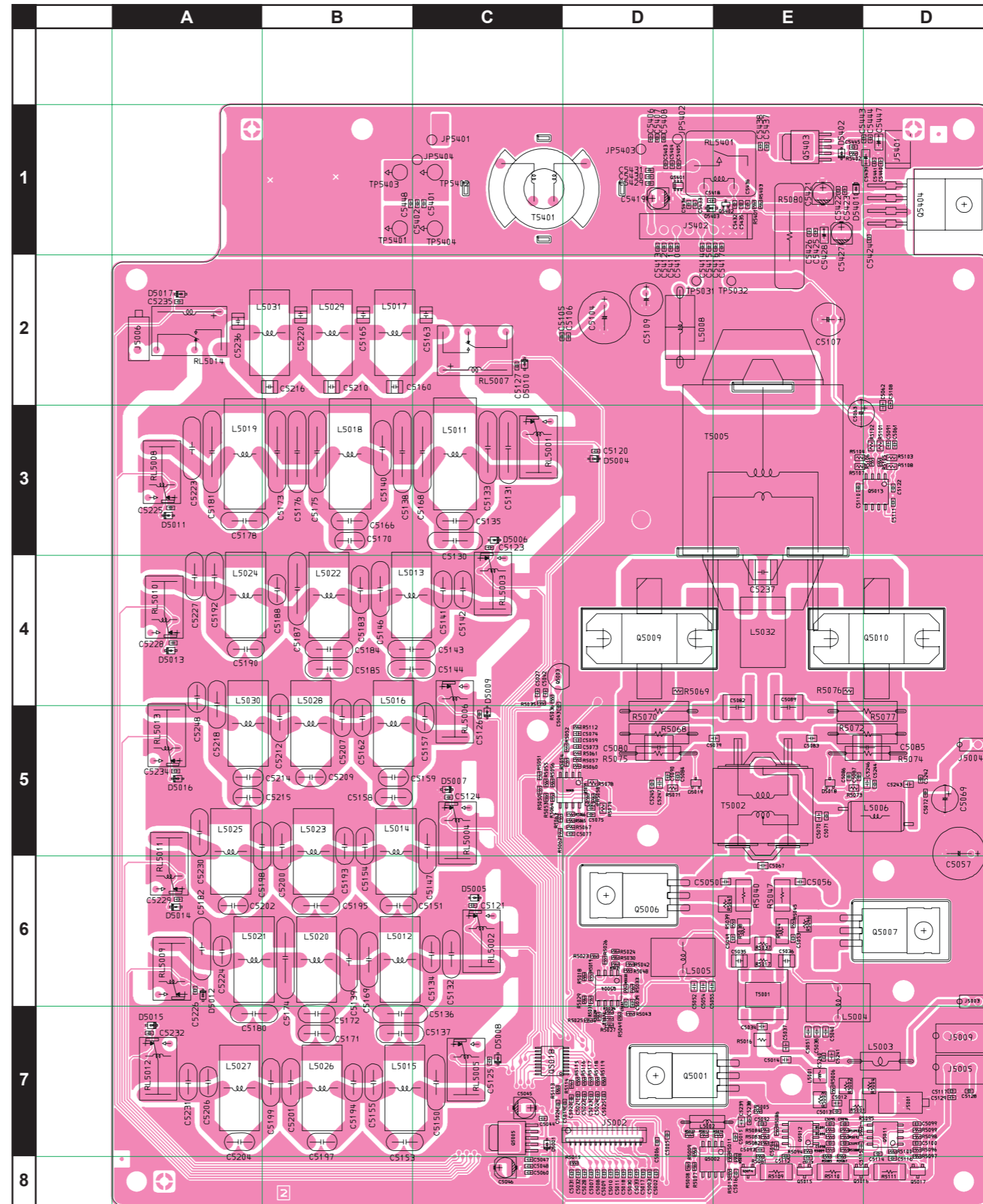

PA-A Unit

Parts Layout (Side B)

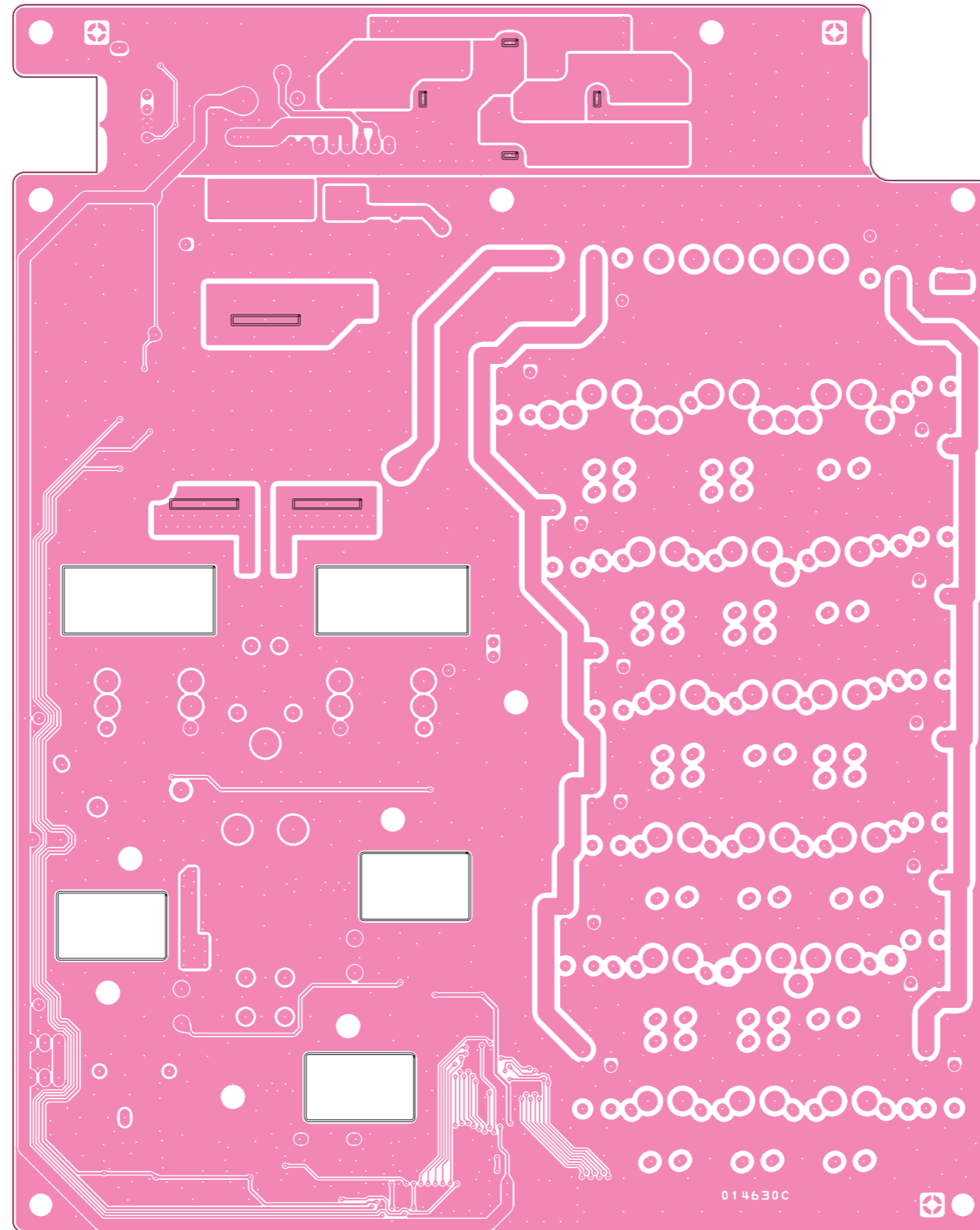

PA-A Unit

Parts List

REF	DESCRIPTION	VALUE	V/W	TOL.	MFR'S DESIG	VXSTD P/N	VERS.	LOT	SIDE	LAY	ADR
PCB with Components						CS1892001					
Printed Circuit Board						AH025H000	FR0146300		1-		
C 5002	CHIP CAP.	0.01uF	50V	B	GRM188B11H103KA01D	K22174823		1-	A	F11	
C 5012	CHIP CAP.	0.001uF	50V	B	GRM40B102K50PT	K22170825		1-	A	H10	
C 5013	CHIP CAP.	0.047uF	25V	F	GRM39F473Z25PT	K22145002		1-	A	H11	
C 5014	CHIP CAP.	0.047uF	50V	B	GRM40B473M50PT	K22170823		1-	A	G10	
C 5015	CHIP CAP.	0.047uF	25V	F	GRM39F473Z25PT	K22145002		1-	A	G11	
C 5016	CHIP CAP.	0.01uF	50V	B	GRM188B11H103KA01D	K22174823		1-	A	G11	
C 5018	CHIP CAP.	0.01uF	50V	B	GRM188B11H103KA01D	K22174823		1-	A	F11	
C 5027	CHIP CAP.	0.001uF	25V	CH	GRM1882C1E102JA01D	K22144204		1-	A	E6	
C 5031	CHIP CAP.	0.047uF	25V	F	GRM39F473Z25PT	K22145002		1-	A	E11	
C 5032	CHIP CAP.	0.1uF	25V	F	GRM39F104Z25PT	K22145001		1-	A	E11	
C 5035	CHIP CAP.	0.1uF	250V	X7R	GRM32DR72E104KW01L	K22245801		1-	A	G9	
C 5036	CHIP CAP.	0.1uF	250V	X7R	GRM32DR72E104KW01L	K22245801		1-	A	G9	
C 5037	CHIP CAP.	0.1uF	25V	B	GRM40B104M25PT	K22140811		1-	A	G10	
C 5038	CHIP CAP.	0.001uF	50V	B	GRM40B102K50PT	K22170825		1-	A	H10	
C 5039	CHIP CAP.	0.01uF	50V	B	GRM188B11H103KA01D	K22174823		1-	A	F9	
C 5040	CHIP CAP.	0.01uF	50V	B	GRM40B103K50PT	K22170826		1-	A	H10	
C 5041	CHIP CAP.	0.01uF	50V	B	GRM188B11H103KA01D	K22174823		1-	A	F9	
C 5042	CHIP CAP.	0.1uF	16V	B	GRM188B11C104KA01D	K22124805		1-	A	E6	
C 5043	CHIP CAP.	0.1uF	16V	B	GRM188B11C104KA01D	K22124805		1-	A	E7	
C 5044	CHIP CAP.	0.047uF	25V	F	GRM39F473Z25PT	K22145002		1-	A	E11	
C 5045	AL.ELECTRO.CAP.	10uF	35V		EEE1VA100WR	K48160006		1-	A	E11	
C 5046	AL.ELECTRO.CAP.	10uF	35V		EEE1VA100WR	K48160006		1-	A	D11	
C 5047	CHIP CAP.	0.047uF	25V	F	GRM39F473Z25PT	K22145002		1-	A	E11	
C 5048	CHIP CAP.	0.01uF	50V	B	GRM188B11H103KA01D	K22174823		1-	A	E11	
C 5049	CHIP CAP.	68pF	50V	CH	GRM1882C1H680JA01D	K22174231		1-	A	G9	
C 5050	CHIP CAP.	0.047uF	50V	B	GRM40B473M50PT	K22170823		1-	A	G8	
C 5051	CHIP CAP.	0.1uF	25V	B	GRM40B104M25PT	K22140811		1-	A	G10	
C 5052	CHIP CAP.	0.1uF	25V	B	GRM40B104M25PT	K22140811		1-	A	F9	
C 5053	CHIP CAP.	68pF	50V	CH	GRM1882C1H680JA01D	K22174231		1-	A	G9	
C 5054	CHIP CAP.	0.01uF	50V	B	GRM40B103K50PT	K22170826		1-	A	F9	
C 5055	CHIP CAP.	0.001uF	50V	B	GRM40B102K50PT	K22170825		1-	A	F9	
C 5056	CHIP CAP.	0.047uF	50V	B	GRM40B473M50PT	K22170823		1-	A	G8	
C 5057	AL.ELECTRO.CAP.	1000uF	16V		RE3-16V102MH3#	K40129096		1-	A	I8	
C 5059	CHIP CAP.	0.01uF	50V	B	GRM188B11H103KA01D	K22174823		1-	A	E7	
C 5060	CHIP CAP.	0.047uF	25V	F	GRM39F473Z25PT	K22145002		1-	A	E11	
C 5062	CHIP CAP.	0.1uF	25V	B	GRM40B104M25PT	K22140811		1-	A	H4	
C 5067	CHIP CAP.	150pF	200V	CH	GRM21B2C2D151JV01L	K22230230		1-	A	G8	
C 5069	AL.ELECTRO.CAP.	10uF	50V		RE2-50V100ME3#-T2	K46170021		1-	A	I7	
C 5070	CHIP CAP.	0.1uF	25V	B	GRM40B104M25PT	K22140811		1-	A	H8	
C 5072	CHIP CAP.	0.047uF	25V	F	GRM39F473Z25PT	K22145002		1-	A	I7	
C 5074	CHIP CAP.	0.01uF	50V	B	GRM188B11H103KA01D	K22174823		1-	A	E7	
C 5075	CHIP CAP.	0.01uF	50V	B	GRM188B11H103KA01D	K22174823		1-	A	E8	
C 5076	CHIP CAP.	0.01uF	50V	B	GRM188B11H103KA01D	K22174823		1-	A	E8	
C 5079	CHIP CAP.	0.01uF	250V	X7R	GRM21BR72E103KW03L	K22240801		1-	A	G7	
C 5082	CERAMIC CAP.	0.0068uF	200V	SL	GRM55R1X2D682JV01L	K22236101		1-	A	G7	
C 5083	CHIP CAP.	0.01uF	250V	X7R	GRM21BR72E103KW03L	K22240801		1-	A	G7	
C 5084	CHIP CAP.	0.1uF	25V	F	GRM39F104Z25PT	K22145001		1-	A	F7	
C 5086	CHIP CAP.	0.1uF	25V	F	GRM39F104Z25PT	K22145001		1-	A	H7	
C 5087	CHIP CAP.	0.1uF	25V	F	GRM39F104Z25PT	K22145001		1-	A	H7	
C 5089	CERAMIC CAP.	0.0068uF	200V	SL	GRM55R1X2D682JV01L	K22236101		1-	A	G7	
C 5090	CHIP CAP.	0.1uF	25V	F	GRM39F104Z25PT	K22145001		1-	A	F7	
C 5091	CHIP CAP.	0.047uF	25V	F	GRM39F473Z25PT	K22145002		1-	A	H4	
C 5092	CHIP CAP.	0.1uF	16V	B	GRM188B11C104KA01D	K22124805		1-	A	G11	
C 5093	CHIP CAP.	0.1uF	16V	B	GRM188B11C104KA01D	K22124805		1-	A	G11	
C 5094	CHIP CAP.	0.047uF	25V	F	GRM39F473Z25PT	K22145002		1-	A	G11	
C 5095	CHIP CAP.	0.1uF	16V	B	GRM188B11C104KA01D	K22124805		1-	A	H11	
C 5096	CHIP CAP.	0.1uF	16V	B	GRM188B11C104KA01D	K22124805		1-	A	H11	
C 5097	CHIP CAP.	0.1uF	16V	B	GRM188B11C104KA01D	K22124805		1-	A	H11	
C 5098	CHIP CAP.	0.1uF	16V	B	GRM188B11C104KA01D	K22124805		1-	A	H11	
C 5099	CHIP CAP.	0.1uF	16V	B	GRM188B11C104KA01D	K22124805		1-	A	I11	
C 5100	CHIP CAP.	0.1uF	16V	B	GRM188B11C104KA01D	K22124805		1-	A	I11	
C 5104	AL.ELECTRO.CAP.	1000uF	16V		RE3-16V102MH3#	K40129096		1-	A	E3	
C 5105	CHIP CAP.	0.01uF	50V	B	GRM188B11H103KA01D	K22174823		1-	A	E3	
C 5106	CHIP CAP.	0.01uF	50V	B	GRM188B11H103KA01D	K22174823		1-	A	E3	
C 5107	AL.ELECTRO.CAP.	100uF	25V		RE2-25V101MH3#	K40149028		1-	A	H3	
C 5108	CHIP CAP.	0.01uF	50V	B	GRM188B11H103KA01D	K22174823		1-	A	H4	
C 5109	AL.ELECTRO.CAP.	100uF	25V		RE2-25V101MH3#	K40149028		1-	A	F2	
C 5110	CHIP CAP.	0.047uF	25V	F	GRM39F473Z25PT	K22145002		1-	A	H4	
C 5111	CHIP CAP.	0.047uF	25V	F	GRM39F473Z25PT	K22145002		1-	A	H4	
C 5112	CHIP CAP.	0.1uF	16V	B	GRM188B11C104KA01D	K22124805		1-	A	G11	
C 5113	CHIP CAP.	0.1uF	16V	B	GRM188B11C104KA01D	K22124805		1-	A	G11	

PA-A Unit

Parts List

REF	DESCRIPTION	VALUE	V/W	TOL.	MFR'S DESIG	VXSTD P/N	VERS.	LOT	SIDE	LAY ADR
C 5114	CHIP CAP.	0.1uF	16V	B	GRM188B11C104KA01D	K22124805		1-	A	H11
C 5115	CHIP CAP.	0.047uF	25V	F	GRM39F473Z25PT	K22145002		1-	A	H11
C 5116	CHIP CAP.	0.1uF	16V	B	GRM188B11C104KA01D	K22124805		1-	A	H11
C 5117	CHIP CAP.	0.01uF	50V	B	GRM188B11H103KA01D	K22174823		1-	A	I10
C 5120	CHIP CAP.	0.047uF	25V	F	GRM39F473Z25PT	K22145002		1-	A	E4
C 5121	CHIP CAP.	0.047uF	25V	F	GRM39F473Z25PT	K22145002		1-	A	D8
C 5122	CHIP CAP.	0.001uF	25V	CH	GRM1882C1E102JA01D	K22144204		1-	A	H4
C 5123	CHIP CAP.	0.047uF	25V	F	GRM39F473Z25PT	K22145002		1-	A	D5
C 5124	CHIP CAP.	0.047uF	25V	F	GRM39F473Z25PT	K22145002		1-	A	D7
C 5125	CHIP CAP.	0.047uF	25V	F	GRM39F473Z25PT	K22145002		1-	A	D10
C 5126	CHIP CAP.	0.047uF	25V	F	GRM39F473Z25PT	K22145002		1-	A	D7
C 5127	CHIP CAP.	0.047uF	25V	F	GRM39F473Z25PT	K22145002		1-	A	E3
C 5129	CHIP CAP.	0.001uF	50V	B	GRM188B11H102KA01D	K22174821		1-	A	I10
C 5130	CERAMIC CAP.	330pF	500V	SL	RT-HM11SKSL331J	K26270063		1-	A	D5
C 5131	CERAMIC CAP.	560pF	500V	SL	HM15S.JSL561J	K00279025		1-	A	D4
C 5132	CERAMIC CAP.	470pF	500V	SL	HM13S.JSL471J	K00279024		1-	A	D9
C 5133	CERAMIC CAP.	560pF	500V	SL	HM15S.JSL561J	K00279025		1-	A	D4
C 5134	CERAMIC CAP.	330pF	500V	SL	RT-HM11SKSL331J	K26270063		1-	A	D9
C 5135	CERAMIC CAP.	150pF	500V	SL	RT-HM74SKSL151J	K26270059		1-	A	D5
C 5136	CERAMIC CAP.	330pF	500V	SL	RT-HM11SKSL331J	K26270063		1-	A	C10
C 5137	CERAMIC CAP.	82pF	500V	CH	RT-HM95SKCH820J	K26270162		1-	A	C10
C 5138	CERAMIC CAP.	0.001uF	500V	SL	HM17S.JSL102J	K00279028		1-	A	C4
C 5139	CERAMIC CAP.	470pF	500V	SL	HM13S.JSL471J	K00279024		1-	A	C9
C 5140	CERAMIC CAP.	390pF	500V	SL	RT-HM11SKSL391J	K26270064		1-	A	C4
C 5141	CERAMIC CAP.	120pF	500V	SL	RT-HM74SKSL121J	K26270058		1-	A	D5
C 5142	CERAMIC CAP.	120pF	500V	SL	RT-HM74SKSL121J	K26270058		1-	A	D5
C 5143	CERAMIC CAP.	220pF	500V	SL	RT-HM95SKSL221J	K26270061		1-	A	D6
C 5144	CERAMIC CAP.	68pF	500V	CH	RT-HM95SKCH680J	K26270161		1-	A	D6
C 5146	CERAMIC CAP.	330pF	500V	SL	RT-HM11SKSL331J	K26270063		1-	A	C5
C 5147	CERAMIC CAP.	120pF	500V	CH	RT-HM11SKCH121J	K26270164		1-	A	D8
C 5150	CERAMIC CAP.	100pF	500V	CH	RT-HM11SKCH101J	K26270163		1-	A	D10
C 5151	CERAMIC CAP.	150pF	500V	SL	RT-HM74SKSL151J	K26270059		1-	A	C9
C 5153	CERAMIC CAP.	47pF	500V	CH	RT-HM74SKCH470J	K26270159		1-	A	D11
C 5154	CERAMIC CAP.	150pF	500V	SL	RT-HM74SKSL151J	K26270059		1-	A	C8
C 5155	CERAMIC CAP.	120pF	500V	SL	RT-HM74SKSL121J	K26270058		1-	A	C10
C 5157	CERAMIC CAP.	22pF	500V	CH	RT-HM60SKCH220J	K26270155		1-	A	D7
C 5158	CERAMIC CAP.	33pF	500V	CH	RT-HM74SKCH330J	K26270157		1-	A	C7
C 5159	CERAMIC CAP.	27pF	500V	CH	RT-HM60SKCH270J	K26270156		1-	A	C7
C 5160	FILM CAP.	3pF	500V		UC232H0030D-T	K33279027		1-	A	C3
C 5162	CERAMIC CAP.	39pF	500V	CH	RT-HM74SKCH390J	K26270158		1-	A	C7
C 5162	CERAMIC CAP.	10pF	500V	CH	RT-HM60SKCH100D	K26270151		3-	A	C7
C 5163	FILM CAP.	18pF	500V		UC232H0180J-T	K33279029		1-	A	D3
C 5165	FILM CAP.	82pF	500V		UC232H0820J-T	K33279033		1-	A	C3
C 5166	CERAMIC CAP.	150pF	500V	SL	RT-HM74SKSL151J	K26270059		1-	A	C5
C 5168	CERAMIC CAP.	0.001uF	500V	SL	HM17S.JSL102J	K00279028		1-	A	D4
C 5169	CERAMIC CAP.	390pF	500V	SL	RT-HM11SKSL391J	K26270064		1-	A	C9
C 5170	CERAMIC CAP.	100pF	500V	SL	RT-HM60SKSL101J	K26270057		1-	A	C5
C 5171	CERAMIC CAP.	150pF	500V	SL	RT-HM74SKSL151J	K26270059		1-	A	C10
C 5172	CERAMIC CAP.	47pF	500V	CH	RT-HM74SKCH470J	K26270159		1-	A	C10
C 5173	CERAMIC CAP.	0.001uF	500V	SL	HM17S.JSL102J	K00279028		1-	A	B4
C 5174	CERAMIC CAP.	0.001uF	500V	SL	HM17S.JSL102J	K00279028		1-	A	B9
C 5175	CERAMIC CAP.	820pF	500V	SL	HM17S.JSL821J	K00279027		1-	A	C4
C 5176	CERAMIC CAP.	820pF	500V	SL	HM17S.JSL821J	K00279027		1-	A	B4
C 5178	CERAMIC CAP.	82pF	500V	CH	RT-HM95SKCH820J	K26270162		1-	A	B5
C 5180	CERAMIC CAP.	68pF	500V	CH	RT-HM95SKCH680J	K26270161		1-	A	B10
C 5181	CERAMIC CAP.	0.001uF	500V	SL	HM17S.JSL102J	K00279028		1-	A	A4
C 5182	CERAMIC CAP.	470pF	500V	SL	HM13S.JSL471J	K00279024		1-	A	A9
C 5183	CERAMIC CAP.	270pF	500V	SL	RT-HM95SKSL271J	K26270062		1-	A	C5
C 5184	CERAMIC CAP.	82pF	500V	CH	RT-HM95SKCH820J	K26270162		1-	A	C6
C 5185	CERAMIC CAP.	56pF	500V	CH	RT-HM95SKCH560J	K26270160		1-	A	C6
C 5187	CERAMIC CAP.	680pF	500V	SL	HM15S.JSL681J	K00279026		1-	A	B5
C 5188	CERAMIC CAP.	22pF	500V	CH	RT-HM60SKCH220J	K26270155		1-	A	B5
C 5190	CERAMIC CAP.	47pF	500V	CH	RT-HM74SKCH470J	K26270159		1-	A	B6
C 5192	CERAMIC CAP.	220pF	500V	SL	RT-HM95SKSL221J	K26270061		1-	A	B5
C 5193	CERAMIC CAP.	150pF	500V	SL	RT-HM74SKSL151J	K26270059		1-	A	C8
C 5194	CERAMIC CAP.	120pF	500V	SL	RT-HM74SKSL121J	K26270058		1-	A	C10
C 5195	CERAMIC CAP.	68pF	500V	CH	RT-HM95SKCH680J	K26270161		1-	A	C9
C 5197	CERAMIC CAP.	27pF	500V	CH	RT-HM60SKCH270J	K26270156		1-	A	C11
C 5198	CERAMIC CAP.	82pF	500V	CH	RT-HM95SKCH820J	K26270162		1-	A	B8
C 5199	CERAMIC CAP.	82pF	500V	CH	RT-HM95SKCH820J	K26270162		1-	A	B10
C 5200	CERAMIC CAP.	270pF	500V	SL	RT-HM95SKSL271J	K26270062		1-	A	B8
C 5201	CERAMIC CAP.	180pF	500V	SL	RT-HM95SKSL181J	K26270060		1-	A	B10
C 5202	CERAMIC CAP.	22pF	500V	CH	RT-HM60SKCH220J	K26270155		1-	A	B9

PA-A Unit

Parts List

REF	DESCRIPTION	VALUE	V/W	TOL.	MFR'S DESIG	VXSTD P/N	VERS.	LOT	SIDE	LAY ADR
C 5204	CERAMIC CAP.	9pF	500V	CH	RT-HM60SKCH090D	K26270150		1-	A	B11
C 5206	CERAMIC CAP.	100pF	500V	SL	RT-HM60SKSL101J	K26270057		1-	A	A10
C 5207	CERAMIC CAP.	120pF	500V	SL	RT-HM74SKSL121J	K26270058		1-	A	C7
C 5209	CERAMIC CAP.	27pF	500V	CH	RT-HM60SKCH270J	K26270156		1-	A	C7
C 5210	FILM CAP.	7pF	500V		UC232H0070D-T	K33279046		1-	A	C3
C 5212	CERAMIC CAP.	180pF	500V	SL	RT-HM95SKSL181J	K26270060		1-	A	B7
C 5214	CERAMIC CAP.	4pF	500V	CH	RT-HM60SKCH040C	K26270145		1-	A	B7
C 5215	CERAMIC CAP.	7pF	500V	CH	RT-HM60SKCH070D	K26270148		1-	A	B7
C 5216	FILM CAP.	18pF	500V		UC232H0180J-T	K33279029		1-	A	B3
C 5218	CERAMIC CAP.	82pF	500V	CH	RT-HM95SKCH820J	K26270162		1-	A	B6
C 5220	FILM CAP.	82pF	500V		UC232H0820J-T	K33279033		1-	A	B3
C 5223	CERAMIC CAP.	470pF	500V	SL	HM135JSL471J	K00279024		1-	A	A4
C 5224	CERAMIC CAP.	100pF	500V	SL	RT-HM60SKSL101J	K26270057		1-	A	B9
C 5225	CHIP CAP.	0.047uF	25V	F	GRM39F473Z25PT	K22145002		1-	A	A5
C 5226	CHIP CAP.	0.047uF	25V	F	GRM39F473Z25PT	K22145002		1-	A	A9
C 5227	CERAMIC CAP.	180pF	500V	SL	RT-HM95SKSL181J	K26270060		1-	A	A5
C 5228	CHIP CAP.	0.047uF	25V	F	GRM39F473Z25PT	K22145002		1-	A	A6
C 5229	CHIP CAP.	0.047uF	25V	F	GRM39F473Z25PT	K22145002		1-	A	A8
C 5230	CERAMIC CAP.	180pF	500V	SL	RT-HM95SKSL181J	K26270060		1-	A	A8
C 5231	CERAMIC CAP.	47pF	500V	CH	RT-HM74SKCH470J	K26270159		1-	A	A10
C 5232	CHIP CAP.	0.047uF	25V	F	GRM39F473Z25PT	K22145002		1-	A	A10
C 5234	CHIP CAP.	0.047uF	25V	F	GRM39F473Z25PT	K22145002		1-	A	A7
C 5235	CHIP CAP.	0.047uF	25V	F	GRM39F473Z25PT	K22145002		1-	A	A2
C 5236	FILM CAP.	39pF	500V		UC232H0390J-T	K33279038		1-	A	B3
C 5237	FILM CAP.	560pF	500V		UC552H5600J-T	K33279041		1-	A	G5
C 5248	CERAMIC CAP.	10pF	500V	CH	RT-HM60SKCH100D	K26270151		1-	A	A6
C 5249	CHIP CAP.	220pF	50V	CH	GRM1882C1H221JA01D	K22174243		1-		
C 5250	CHIP CAP.	220pF	50V	CH	GRM1882C1H221JA01D	K22174243		1-		
C 5251	FILM CAP.	82pF	500V		UC232H0820J-T	K33279033		3-		
C 5252	FILM CAP.	82pF	500V		UC232H0820J-T	K33279033		3-		
C 5401	CHIP CAP.	0.01uF	50V	B	GRM188B11H103KA01D	K22174823		1-	A	D1
C 5402	CHIP CAP.	0.001uF	50V	B	GRM188B11H102KA01D	K22174809		1-	A	D1
C 5403	CHIP CAP.	0.047uF	16V	B	GRM39B473K16PT	K22124804		1-	A	F1
C 5404	CHIP CAP.	0.001uF	50V	B	GRM188B11H102KA01D	K22174809		1-	A	F1
C 5411	CHIP CAP.	0.1uF	16V	B	GRM188B11C104KA01D	K22124805		1-	A	F2
C 5412	CHIP CAP.	0.01uF	50V	B	GRM188B11H103KA01D	K22174823		1-	A	F2
C 5413	CHIP CAP.	0.001uF	50V	B	GRM188B11H102KA01D	K22174809		1-	A	F2
C 5415	CHIP CAP.	0.1uF	16V	B	GRM188B11C104KA01D	K22124805		1-	A	F2
C 5416	CHIP CAP.	0.01uF	50V	B	GRM188B11H103KA01D	K22174823		1-	A	G2
C 5417	CHIP CAP.	0.001uF	50V	B	GRM188B11H102KA01D	K22174809		1-	A	G2
C 5418	CHIP CAP.	0.01uF	50V	B	GRM188B11H103KA01D	K22174823		1-	A	F1
C 5419	AL.ELECTRO.CAP.	10uF	35V		EEE1VA100WR	K48160006		1-	A	F1
C 5421	AL.ELECTRO.CAP.	10uF	35V		EEE1VA100WR	K48160006		1-	A	H1
C 5422	CHIP CAP.	0.01uF	50V	B	GRM188B11H103KA01D	K22174823		1-	A	H1
C 5423	CHIP CAP.	0.001uF	50V	B	GRM188B11H102KA01D	K22174809		1-	A	H1
C 5424	CHIP CAP.	0.01uF	50V	B	GRM188B11H103KA01D	K22174823		1-	A	H2
C 5425	CHIP CAP.	0.001uF	50V	B	GRM188B11H102KA01D	K22174809		1-	A	H2
C 5426	CHIP CAP.	0.01uF	50V	B	GRM188B11H103KA01D	K22174823		1-	A	G2
C 5427	AL.ELECTRO.CAP.	10uF	35V		EEE1VA100WR	K48160006		1-	A	H2
C 5428	CHIP TA.CAP.	1uF	16V		TESVA1C105M1-8R	K78120009		1-	A	H2
C 5429	CHIP CAP.	0.001uF	50V	B	GRM188B11H102KA01D	K22174809		1-	A	F1
C 5430	CHIP CAP.	0.01uF	50V	B	GRM188B11H103KA01D	K22174823		1-	A	F1
C 5431	CHIP CAP.	0.1uF	16V	B	GRM188B11C104KA01D	K22124805		1-	A	F1
C 5432	CHIP CAP.	0.01uF	50V	B	GRM188B11H103KA01D	K22174823		1-	A	G2
C 5433	CHIP CAP.	0.01uF	50V	B	GRM188B11H103KA01D	K22174823		1-	A	F2
C 5436	CHIP CAP.	0.01uF	50V	B	GRM188B11H103KA01D	K22174823		1-	A	G2
C 5437	CHIP CAP.	0.1uF	16V	B	GRM188B11C104KA01D	K22124805		1-	A	G1
C 5438	CHIP CAP.	0.01uF	50V	B	GRM188B11H103KA01D	K22174823		1-	A	G1
C 5448	CHIP CAP.	0.1uF	16V	B	GRM188B11C104KA01D	K22124805		1-	A	C1
D 5001	DIODE				BAS316	G2070716		1-	A	E11
D 5018	DIODE				DAN202U T106	G2070162		1-	A	H7
D 5019	DIODE				DAN202U T106	G2070162		1-	A	F7
D 5401	DIODE				RSX101VA-30TR	G2070984		1-	A	H1
D 5403	DIODE				BAS316	G2070716		1-	A	F2
D 5404	DIODE				BAS316	G2070716		2-		
D 5405	DIODE				BAS316	G2070716		2-		
J 5001	CONNECTOR				TMP-S01X-C1	P1091254		1-	A	H10
J 5002	CONNECTOR				30FLT-SM1-TB	P1091142		1-	A	E11
J 5003	CONNECTOR				IMSA-9202B-1-02-T	P0091174		1-	A	I9
J 5004	CONNECTOR				IMSA-9202B-1-02-T	P0091174		1-	A	I7
J 5005	CONNECTOR				B03B-XH-A	P0091413		1-	A	I10
J 5006	CONNECTOR				TMP-S01X-C1	P1091254		1-	A	A3
J 5009	CONNECTOR				B03B-XH-A	P0091413		1-	A	I10

PA-A Unit

Parts List

REF	DESCRIPTION	VALUE	V/W	TOL.	MFR'S DESIG	VXSTD P/N	VERS.	LOT	SIDE	LAY ADR
J 5402	CONNECTOR				SC25-08WS	P0090627		1-	A	G2
L 5001	CHIP COIL	2.2uH			C2520C-2R2K	L1690731		1-	A	H10
L 5002	M.RFC	33uH			LAL03TA330K	L1790101		1-	A	F11
L 5003	M.RFC	2.2uH			LAL04NA2R2M	L1190319		1-	A	H10
L 5004	TOROIDAL COIL	41uH			41.00U 3A FR9.5°5	L0021432		1-	A	H9
L 5005	TOROIDAL COIL	41uH			41.00U 3A FR9.5°5	L0021432		1-	A	F9
L 5006	RFC WITH BEADS				FB-43-5111	L1020015		1-	A	H8
L 5008	RFC WITH BEADS				3A RI5.8X6.4-2	L1020728		1-	A	F2
L 5011	TOROIDAL COIL	3.85uH			3.85U T68-2	L0022963		1-	A	D4
L 5012	TOROIDAL COIL	1.21uH			1.21U T50-2	L0022965		1-	A	D9
L 5013	TOROIDAL COIL	0.85uH			0.85U T50-6	L0022968		1-	A	D5
L 5014	TOROIDAL COIL	0.42uH			0.42U T50-6	L0022971		1-	A	C8
L 5015	TOROIDAL COIL	0.4uH			0.40U T50-6	L0022974		1-	A	D10
L 5016	TOROIDAL COIL	0.25uH			0.25U T50-6	L0022976		1-	A	C7
L 5017	TOROIDAL COIL	0.21uH			0.21U T50-10	L0022979		1-	A	C3
L 5018	TOROIDAL COIL	5.1uH			5.10U T68-2	L0022964		1-	A	C4
L 5019	TOROIDAL COIL	5.1uH			5.10U T68-2	L0022964		1-	A	B4
L 5020	TOROIDAL COIL	1.85uH			1.85U T50-2	L0022966		1-	A	C9
L 5021	TOROIDAL COIL	2uH			2.00U T50-2	L0022967		1-	A	B9
L 5022	TOROIDAL COIL	1.31uH			1.31U T50-6	L0022969		1-	A	C5
L 5023	TOROIDAL COIL	0.63uH			0.63U T50-6	L0022972		1-	A	C8
L 5024	TOROIDAL COIL	1.39uH			1.39U T50-6	L0022970		1-	A	B5
L 5025	TOROIDAL COIL	0.7uH			0.70U T50-6	L0022973		1-	A	B8
L 5026	TOROIDAL COIL	0.5uH			0.50U T50-6	L0022975		1-	A	C10
L 5027	TOROIDAL COIL	0.5uH			0.50U T50-6	L0022975		1-	A	B10
L 5028	TOROIDAL COIL	0.34uH			0.34U T50-6	L0022977		1-	A	C7
L 5029	TOROIDAL COIL	0.21uH			0.21U T50-10	L0022979		1-	A	C3
L 5030	TOROIDAL COIL	0.34uH			0.34U T50-6	L0022977		1-	A	B7
L 5031	TOROIDAL COIL	0.18uH			0.18U T50-10	L0022978		1-	A	B3
L 5032	TOROIDAL COIL	6uH			U 6H3 10X5X5	L0022039		1-	A	G6
P 5001	CONNECTOR				IMSA-9206H-T	P1090988		1-		
P 5002	CONNECTOR				IMSA-9206H-T	P1090988		1-		
P 5003	TERMINAL				B4 AG M3	Q6000114		1-		
Q 5001	FET				RD06HHF1-01	G3090145		1-	A	F10
Q 5002	IC				M5223AFP 600C	G1092955		1-	A	F11
Q 5003	IC				LM19CIZ	G1094150		1-	A	E6
Q 5004	IC				M5223AFP 600C	G1092955		1-	A	E9
Q 5005	IC				PQ09TZ1U	G1092599		1-	A	E11
Q 5006	FET				RD16HHF1	G3090148		1-	A	E8
Q 5007	FET				RD16HHF1	G3090148		1-	A	I9
Q 5008	IC				M5223AFP 600C	G1092955		1-	A	E7
Q 5009	FET				RD100HHF1	G3090151		1-	A	F6
Q 5010	FET				RD100HHF1	G3090151		1-	A	H6
Q 5011	IC				M5223AFP 600C	G1092955		1-	A	H11
Q 5012	IC				M5223AFP 600C	G1092955		1-	A	G11
Q 5013	IC				M5218AFP-600C	G1091607		1-	A	H4
Q 5014	TRANSISTOR				DTD123YK T146	G3070157		1-	A	G11
Q 5015	TRANSISTOR				DTD123YK T146	G3070157		1-	A	G11
Q 5016	TRANSISTOR				DTD123YK T146	G3070157		1-	A	H11
Q 5017	TRANSISTOR				DTD123YK T146	G3070157		1-	A	I11
Q 5018	IC				TD62783AFN(EL)	G1092700		1-	A	E10
Q 5401	TRANSISTOR				UMD5N TR	G3070343		1-	A	F1
Q 5402	TRANSISTOR				DTC123JE TL	G3070323		1-	A	G1
Q 5404	IC				PQ09RF21J00H	G1094351		1-	A	I2
R 5001	CHIP RES.	18	1/4W	5%	RMC1/4 180JATP	J24245180		1-	A	H11
R 5002	CHIP RES.	330	1/4W	5%	RMC1/4 331JATP	J24245331		1-	A	H10
R 5003	CHIP RES.	680	1/4W	5%	RMC1/4 681JATP	J24245681		1-	A	H10
R 5004	CHIP RES.	330	1/4W	5%	RMC1/4 331JATP	J24245331		1-	A	H10
R 5005	CHIP RES.	820	1/16W	5%	RMC1/16 821JATP	J24185821		1-	A	G11
R 5006	CHIP RES.	1.8k	1/16W	5%	RMC1/16 182JATP	J24185182		1-	A	H10
R 5007	CHIP RES.	0	1/16W	5%	RMC1/16 000JATP	J24185000		1-	A	F11
R 5009	CHIP RES.	100k	1/16W	5%	RMC1/16 104JATP	J24185104		1-	A	F11
R 5010	CHIP RES.	3.9k	1/16W	5%	RMC1/16 392JATP	J24185392		1-	A	G11
R 5011	CHIP RES.	100k	1/16W	5%	RMC1/16 104JATP	J24185104		1-	A	G11
R 5012	CHIP RES.	100k	1/16W	5%	RMC1/16 104JATP	J24185104		1-	A	F11
R 5013	CHIP RES.	10k	1/16W	5%	RMC1/16 103JATP	J24185103		1-	A	G11
R 5014	CHIP RES.	100k	1/16W	5%	RMC1/16 104JATP	J24185104		1-	A	G11
R 5015	CHIP RES.	1k	1/16W	5%	RMC1/16 102JATP	J24185102		1-	A	E11
R 5017	CHIP RES.	470	1/4W	5%	RMC1/4 471JATP	J24245471		1-	A	G9
R 5018	CHIP RES.	2.7k	1/16W	5%	RMC1/16 272JATP	J24185272		1-	A	E9
R 5019	CHIP RES.	100k	1/16W	5%	RMC1/16 104JATP	J24185104		1-	A	E9
R 5020	CHIP RES.	10k	1/16W	5%	RMC1/16 103JATP	J24185103		1-	A	F9
R 5021	CHIP RES.	100k	1/16W	5%	RMC1/16 104JATP	J24185104		1-	A	F9

PA-A Unit

Parts List

REF	DESCRIPTION	VALUE	V/W	TOL.	MFR'S DESIG	VXSTD P/N	VERS.	LOT	SIDE	LAY ADR
R 5022	CHIP RES.	10k	1/16W	5%	RMC1/16 103JATP	J24185103		1-	A	F11
R 5023	CHIP RES.	0	1/16W	5%	RMC1/16 000JATP	J24185000		1-	A	E9
R 5025	CHIP RES.	0	1/16W	5%	RMC1/16 000JATP	J24185000		1-	A	E10
R 5026	CHIP RES.	100k	1/16W	5%	RMC1/16 104JATP	J24185104		1-	A	E9
R 5028	CHIP RES.	100k	1/16W	5%	RMC1/16 104JATP	J24185104		1-	A	E10
R 5029	CHIP RES.	2.7k	1/16W	5%	RMC1/16 272JATP	J24185272		1-	A	E9
R 5030	CHIP RES.	100k	1/16W	5%	RMC1/16 104JATP	J24185104		1-	A	F9
R 5031	CHIP RES.	100k	1/16W	5%	RMC1/16 104JATP	J24185104		1-	A	E9
R 5032	CHIP RES.	100k	1/16W	5%	RMC1/16 104JATP	J24185104		1-	A	E10
R 5033	CHIP RES.	10k	1/16W	5%	RMC1/16 103JATP	J24185103		1-	A	F9
R 5034	CHIP RES.	100k	1/16W	5%	RMC1/16 104JATP	J24185104		1-	A	E10
R 5035	CHIP RES.	0	1/16W	5%	RMC1/16 000JATP	J24185000		1-	A	E6
R 5036	CHIP RES.	470	1/16W	5%	RMC1/16 471JATP	J24185471		1-	A	E6
R 5038	CHIP RES.	47	1/2W	5%	RK73K2HTE47-OHMJ	J24279013		1-	A	G9
R 5039	CHIP RES.	100	1/16W	5%	RMC1/16 101JATP	J24185101		1-	A	G9
R 5040	CHIP RES.	470	1W	5%	RMC1 471JTE	J24305471		1-	A	G8
R 5041	CHIP RES.	1k	1/4W	5%	RMC1/4 102JATP	J24245102		1-	A	G8
R 5042	CHIP RES.	100	1/16W	5%	RMC1/16 101JATP	J24185101		1-	A	F9
R 5043	CHIP RES.	100	1/16W	5%	RMC1/16 101JATP	J24185101		1-	A	F10
R 5044	CHIP RES.	47	1/2W	5%	RK73K2HTE47-OHMJ	J24279013		1-	A	G9
R 5045	CHIP RES.	100	1/16W	5%	RMC1/16 101JATP	J24185101		1-	A	G9
R 5046	CHIP RES.	1k	1/4W	5%	RMC1/4 102JATP	J24245102		1-	A	G9
R 5047	CHIP RES.	470	1W	5%	RMC1 471JTE	J24305471		1-	A	G8
R 5048	CHIP RES.	10k	1/16W	5%	RMC1/16 103JATP	J24185103		1-	A	F9
R 5049	CHIP RES.	10k	1/16W	5%	RMC1/16 103JATP	J24185103		1-	A	F10
R 5050	CHIP RES.	0	1/16W	5%	RMC1/16 000JATP	J24185000		1-	A	E7
R 5051	CHIP RES.	220	1/16W	5%	RMC1/16 221JATP	J24185221		1-	A	E7
R 5052	CHIP RES.	0	1/16W	5%	RMC1/16 000JATP	J24185000		1-	A	E7
R 5054	CHIP RES.	100k	1/16W	5%	RMC1/16 104JATP	J24185104		1-	A	E7
R 5056	CHIP RES.	100k	1/16W	5%	RMC1/16 104JATP	J24185104		1-	A	E7
R 5057	CHIP RES.	100k	1/16W	5%	RMC1/16 104JATP	J24185104		1-	A	E7
R 5058	CHIP RES.	10k	1/16W	5%	RMC1/16 103JATP	J24185103		1-	A	E7
R 5059	CHIP RES.	10k	1/16W	5%	RMC1/16 103JATP	J24185103		1-	A	E7
R 5060	CHIP RES.	100k	1/16W	5%	RMC1/16 104JATP	J24185104		1-	A	E7
R 5061	CHIP RES.	10k	1/16W	5%	RMC1/16 103JATP	J24185103		1-	A	E7
R 5062	CHIP RES.	0	1/16W	5%	RMC1/16 000JATP	J24185000		1-	A	E8
R 5063	CHIP RES.	100k	1/16W	5%	RMC1/16 104JATP	J24185104		1-	A	E8
R 5064	CHIP RES.	100k	1/16W	5%	RMC1/16 104JATP	J24185104		1-	A	E7
R 5065	CHIP RES.	100k	1/16W	5%	RMC1/16 104JATP	J24185104		1-	A	E8
R 5066	CHIP RES.	100k	1/16W	5%	RMC1/16 104JATP	J24185104		1-	A	E8
R 5067	CHIP RES.	10k	1/16W	5%	RMC1/16 103JATP	J24185103		1-	A	E8
R 5068	METAL FILM RES.	3.3	2W	5%	ERX-2SJ3R3P 3.3	J22339003		1-	A	F7
R 5069	CHIP RES.	1k	1/10W	5%	RMC1/10T 102J	J24205102		1-	A	F6
R 5070	METAL FILM RES.	18	2W	5%	ERG-2SJ180P 18	J22339004		1-	A	F7
R 5071	CHIP RES.	100	1/10W	5%	RMC1/10T 101J	J24205101		1-	A	F7
R 5072	METAL FILM RES.	3.3	2W	5%	ERX-2SJ3R3P 3.3	J22339003		1-	A	H7
R 5073	CHIP RES.	100	1/10W	5%	RMC1/10T 101J	J24205101		1-	A	H7
R 5074	METAL FILM RES.	22	1W	5%	ERG-1SJ220 22	J22305220		1-	A	H7
R 5075	METAL FILM RES.	22	1W	5%	ERG-1SJ220 22	J22305220		1-	A	F7
R 5076	CHIP RES.	1k	1/10W	5%	RMC1/10T 102J	J24205102		1-	A	H6
R 5077	METAL FILM RES.	18	2W	5%	ERG-2SJ180P 18	J22339004		1-	A	H7
R 5078	CHIP RES.	100	1/10W	5%	RMC1/10T 101J	J24205101		1-	A	E7
R 5079	CHIP RES.	100	1/10W	5%	RMC1/10T 101J	J24205101		1-	A	E8
R 5080	SHUNT RES.	0.016		5%	R016	J32009018		1-	A	G1
R 5081	CHIP RES.	10k	1/16W	5%	RMC1/16 103JATP	J24185103		1-	A	G11
R 5082	CHIP RES.	2.7k	1/16W	5%	RMC1/16 272JATP	J24185272		1-	A	G11
R 5083	CHIP RES.	10k	1/16W	5%	RMC1/16 103JATP	J24185103		1-	A	G11
R 5084	CHIP RES.	10k	1/16W	5%	RMC1/16 103JATP	J24185103		1-	A	G11
R 5085	CHIP RES.	10k	1/16W	5%	RMC1/16 103JATP	J24185103		1-	A	H11
R 5086	CHIP RES.	470k	1/16W	5%	RMC1/16 474JATP	J24185474		1-	A	G11
R 5087	CHIP RES.	10k	1/16W	5%	RMC1/16 103JATP	J24185103		1-	A	H11
R 5088	CHIP RES.	3.9k	1/16W	5%	RMC1/16 392JATP	J24185392		1-	A	H11
R 5089	CHIP RES.	3.3k	1/16W	5%	RMC1/16 332JATP	J24185332		1-	A	H11
R 5090	CHIP RES.	10k	1/16W	5%	RMC1/16 103JATP	J24185103		1-	A	H11
R 5091	CHIP RES.	10k	1/16W	5%	RMC1/16 103JATP	J24185103		1-	A	H11
R 5092	CHIP RES.	10k	1/16W	5%	RMC1/16 103JATP	J24185103		1-	A	H11
R 5093	CHIP RES.	10k	1/16W	5%	RMC1/16 103JATP	J24185103		1-	A	H11
R 5094	CHIP RES.	470k	1/16W	5%	RMC1/16 474JATP	J24185474		1-	A	G11
R 5095	CHIP RES.	470k	1/16W	5%	RMC1/16 474JATP	J24185474		1-	A	H11
R 5096	CHIP RES.	4.7k	1/16W	5%	RMC1/16 472JATP	J24185472		1-	A	I11
R 5097	CHIP RES.	10k	1/16W	5%	RMC1/16 103JATP	J24185103		1-	A	I11
R 5098	CHIP RES.	10k	1/16W	5%	RMC1/16 103JATP	J24185103		1-	A	I11
R 5099	CHIP RES.	10k	1/16W	5%	RMC1/16 103JATP	J24185103		1-	A	I11

PA-A Unit

Parts List

REF	DESCRIPTION	VALUE	V/W	TOL.	MFR'S DESIG	VXSTD P/N	VERS.	LOT	SIDE	LAY ADR
R 5100	CHIP RES.	470k	1/16W	5%	RMC1/16 474JATP	J24185474		1-	A	H11
R 5101	CHIP RES.	6.8k	1/10W	0.1%	RR1220P-682-B	J24209094		1-	A	H4
R 5102	CHIP RES.	6.8k	1/10W	0.1%	RR1220P-682-B	J24209094		1-	A	H4
R 5103	CHIP RES.	5.6k	1/10W	0.1%	RR1220P-562-B	J24209092		1-	A	H4
R 5104	CHIP RES.	5.6k	1/10W	0.1%	RR1220P-562-B	J24209092		1-	A	H4
R 5105	CHIP RES.	5.6k	1/16W	0.1%	RN731JTDD5601B25	J24189409		1-	A	H4
R 5106	CHIP RES.	5.6k	1/16W	0.1%	RN731JTDD5601B25	J24189409		1-	A	H4
R 5107	CHIP RES.	140k	1/10W	1%	RMC1/10 1403FTP	J24209015		1-	A	H4
R 5108	CHIP RES.	140k	1/10W	1%	RMC1/10 1403FTP	J24209015		1-	A	H4
R 5109	CHIP RES.	15	1W	5%	RMC1 150JTE	J24305150		1-	A	G11
R 5110	CHIP RES.	15	1W	5%	RMC1 150JTE	J24305150		1-	A	H11
R 5111	CHIP RES.	15	1W	5%	RMC1 150JTE	J24305150		1-	A	H11
R 5112	CHIP RES.	2.7k	1/16W	5%	RMC1/16 272JATP	J24185272		1-	A	E7
R 5113	CHIP RES.	10k	1/16W	5%	RMC1/16 103JATP	J24185103		1-	A	E10
R 5114	CHIP RES.	10k	1/16W	5%	RMC1/16 103JATP	J24185103		1-	A	E10
R 5115	CHIP RES.	10k	1/16W	5%	RMC1/16 103JATP	J24185103		1-	A	E10
R 5116	CHIP RES.	10k	1/16W	5%	RMC1/16 103JATP	J24185103		1-	A	E10
R 5117	CHIP RES.	10k	1/16W	5%	RMC1/16 103JATP	J24185103		1-	A	E10
R 5118	CHIP RES.	10k	1/16W	5%	RMC1/16 103JATP	J24185103		1-	A	E10
R 5119	CHIP RES.	10k	1/16W	5%	RMC1/16 103JATP	J24185103		1-	A	E10
R 5120	CARBON FILM RES.	18k	1/6W	5%	RD16TPJ183 18K	J07225183		1		
R 5120	CHIP RES.	18k	1/16W	5%	RMC1/16 183JATP	J24185183		2-		
R 5121	CHIP RES.	3.9k	1/16W	5%	RMC1/16 392JATP	J24185392		1-		
R 5403	CHIP RES.	0	1/16W	5%	RMC1/16 000JATP	J24185000		1-	A	G2
R 5404	CARBON FILM RES.	3.9k	1/6W	5%	RD16TPJ392 3.9K	J07225392		1		
RL5001	RELAY		DC12V		G5V-1 DC12V	M1190120		1-	A	E4
RL5002	RELAY		DC12V		G5V-1 DC12V	M1190120		1-	A	D9
RL5003	RELAY		DC12V		G5V-1 DC12V	M1190120		1-	A	D5
RL5004	RELAY		DC12V		G5V-1 DC12V	M1190120		1-	A	D8
RL5005	RELAY		DC12V		G5V-1 DC12V	M1190120		1-	A	D10
RL5006	RELAY		DC12V		G5V-1 DC12V	M1190120		1-	A	D6
RL5007	RELAY		DC12V		AG201344 DC12V	M1190124		1-	A	D3
RL5008	RELAY		DC12V		G5V-1 DC12V	M1190120		1-	A	A4
RL5009	RELAY		DC12V		G5V-1 DC12V	M1190120		1-	A	A9
RL5010	RELAY		DC12V		G5V-1 DC12V	M1190120		1-	A	A6
RL5011	RELAY		DC12V		G5V-1 DC12V	M1190120		1-	A	A8
RL5012	RELAY		DC12V		G5V-1 DC12V	M1190120		1-	A	A10
RL5013	RELAY		DC12V		G5V-1 DC12V	M1190120		1-	A	A7
RL5014	RELAY		DC12V		AG201344 DC12V	M1190124		1-	A	B3
RL5401	RELAY		DC12V		ACP331 DC12V	M1190175		1-	A	F1
T 5001	COIL 10WIDE				#223153	L0022857		1-	A	G9
T 5002	COIL PWR-WIDE				D12A RIB10	L0022980		1-	A	G7
T 5002	COIL PWR-WIDE				D12A RIB10	L0022980A		3-	A	G7
T 5005	COIL PWR-WIDE				D12A RIB16	L0022399A		1-	A	G3
T 5401	TOROIDAL COIL				D12A RI16X8X8(H007)	L0022745		1-	A	E1
TP5031	TERMINAL				TP-H MK-10160	Q5000037		1-	A	F2
TP5032	TERMINAL				TP-H MK-10160	Q5000037		1-	A	G2
	SHIELD CASE					R0131670A		1-		
	SHIELD CASE COVER					R0131680		1-		
	LEAF SPRING					R0120250		1-		

TUNER-MAIN Unit

Note

TUNER-MAIN Unit

Parts Layout (Side A)

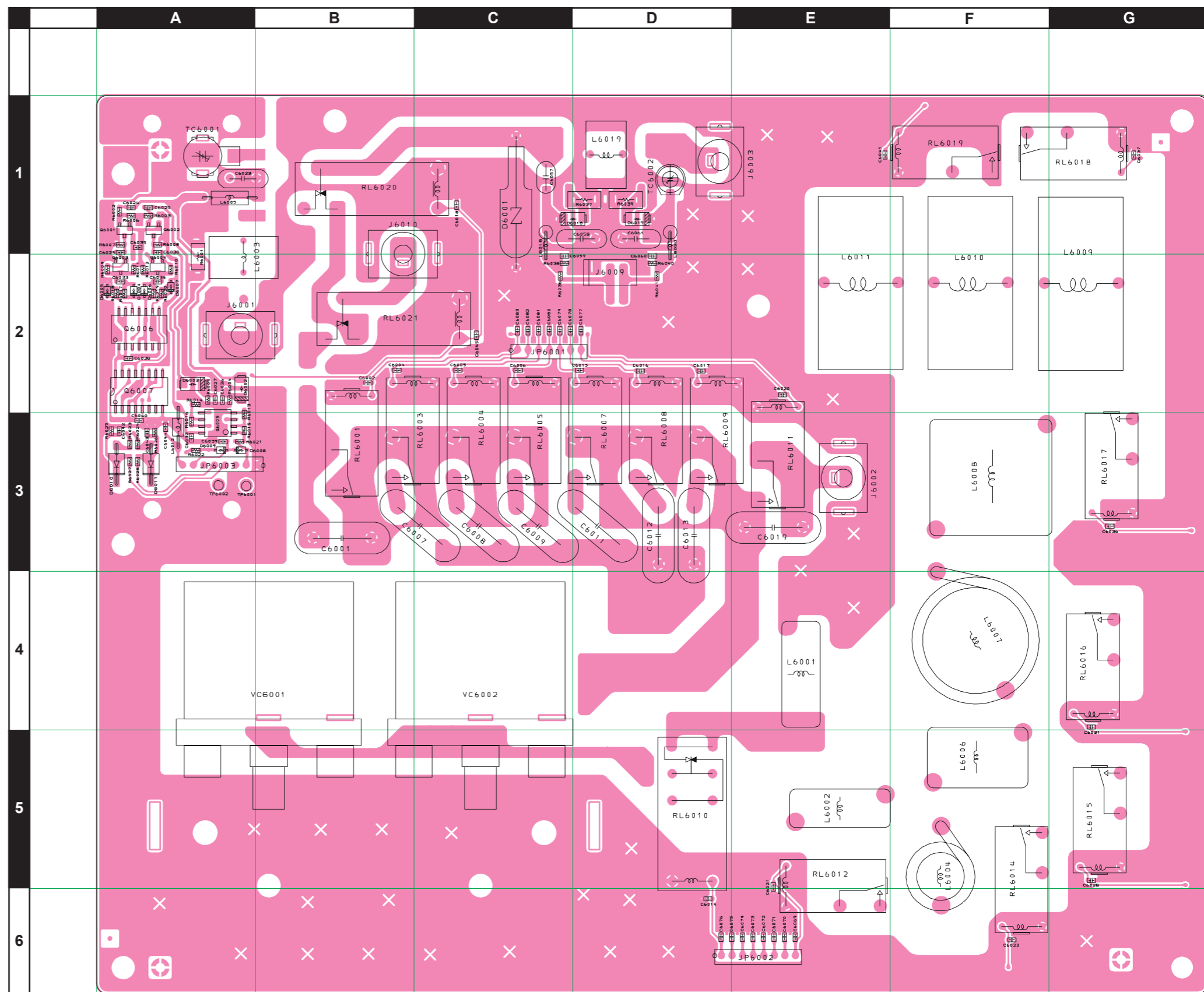
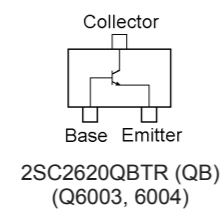
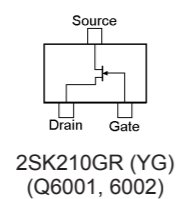
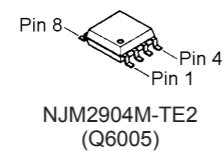
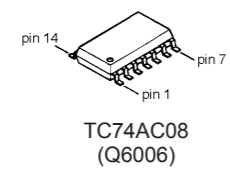
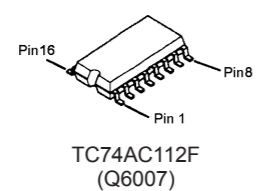

TUNER-MAIN Unit

Parts Layout (Side B)

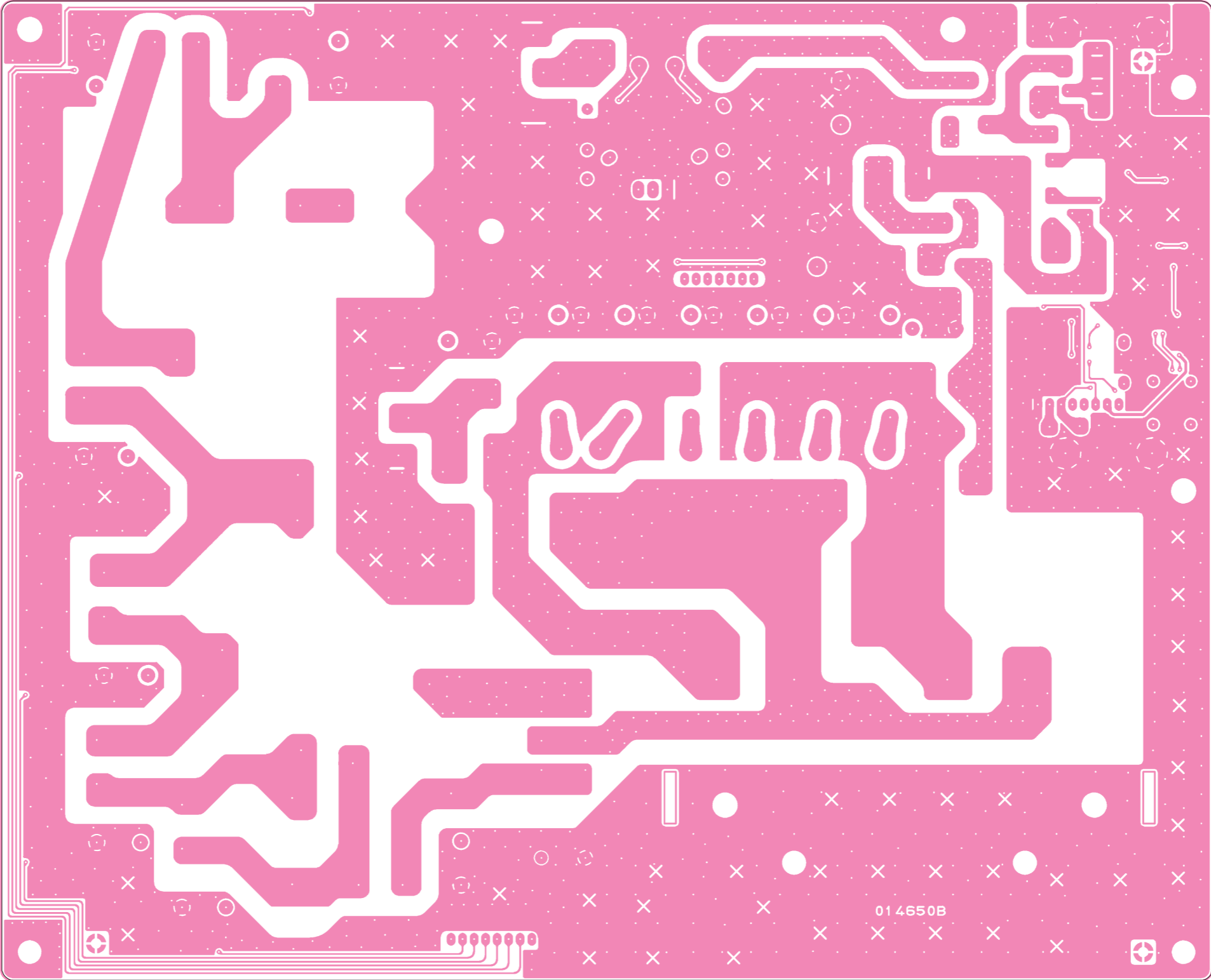

TUNER-MAIN Unit

Parts List

REF	DESCRIPTION	VALUE	V/W	TOL.	MFR'S DESIG	VXSTD P/N	VERS.	LOT	SIDE	LAY ADR
PCB with Components						CB3489001				
Printed Circuit Board						AH025H000	FR014650B		1-	
C 6001	MICA CAP.	47pF	2.5KV		DM30E470J25-0	K30349017		1-	A	B3
C 6002	CHIP CAP.	0.01uF	50V	B	GRM188B11H103KA01D	K22174823		1-	A	B2
C 6004	CHIP CAP.	0.01uF	50V	B	GRM188B11H103KA01D	K22174823		1-	A	B2
C 6005	CHIP CAP.	0.01uF	50V	B	GRM188B11H103KA01D	K22174823		1-	A	C2
C 6006	CHIP CAP.	0.01uF	50V	B	GRM188B11H103KA01D	K22174823		1-	A	C2
C 6007	MICA CAP.	400pF	3KV		DML4 401J30	K30355401		1-	A	B3
C 6008	MICA CAP.	200pF	3KV		DML4 201J30	K30355201		1-	A	C3
C 6009	MICA CAP.	100pF	3KV		DML4 101J30	K30355101		1-	A	C3
C 6011	MICA CAP.	400pF	3KV		DML4 401J30	K30355401		1-	A	D3
C 6012	MICA CAP.	200pF	3KV		DML4 201J30	K30355201		1-	A	D3
C 6013	MICA CAP.	100pF	3KV		DML4 101J30	K30355101		1-	A	D3
C 6014	CHIP CAP.	0.01uF	50V	B	GRM188B11H103KA01D	K22174823		1-	A	D6
C 6015	CHIP CAP.	0.01uF	50V	B	GRM188B11H103KA01D	K22174823		1-	A	D2
C 6016	CHIP CAP.	0.01uF	50V	B	GRM188B11H103KA01D	K22174823		1-	A	D2
C 6017	CHIP CAP.	0.01uF	50V	B	GRM188B11H103KA01D	K22174823		1-	A	D2
C 6018	CHIP CAP.	0.01uF	50V	B	GRM188B11H103KA01D	K22174823		1-	A	C1
C 6019	MICA CAP.	47pF	2.5KV		DM30E470J25-0	K30349017		1-	A	E3
C 6020	CHIP CAP.	0.01uF	50V	B	GRM188B11H103KA01D	K22174823		1-	A	E2
C 6021	CHIP CAP.	0.01uF	50V	B	GRM188B11H103KA01D	K22174823		1-	A	E5
C 6022	CHIP CAP.	0.01uF	50V	B	GRM188B11H103KA01D	K22174823		1-	A	F6
C 6023	CERAMIC CAP.	220pF	500V	SL	RT-HM95SKSL221J	K26270061		1-	A	A1
C 6024	CHIP CAP.	0.01uF	50V	B	GRM188B11H103KA01D	K22174823		1-	A	A1
C 6025	CHIP CAP.	0.01uF	50V	B	GRM188B11H103KA01D	K22174823		1-	A	A1
C 6026	CHIP CAP.	0.01uF	50V	B	GRM188B11H103KA01D	K22174823		1-	A	A2
C 6027	CHIP CAP.	0.01uF	50V	B	GRM188B11H103KA01D	K22174823		1-	A	A2
C 6028	CHIP CAP.	0.01uF	50V	B	GRM188B11H103KA01D	K22174823		1-	A	G5
C 6029	CHIP CAP.	0.01uF	50V	B	GRM188B11H103KA01D	K22174823		1-	A	A1
C 6030	CHIP CAP.	0.01uF	50V	B	GRM188B11H103KA01D	K22174823		1-	A	A1
C 6031	CHIP CAP.	0.01uF	50V	B	GRM188B11H103KA01D	K22174823		1-	A	G4
C 6032	CHIP CAP.	0.01uF	50V	B	GRM188B11H103KA01D	K22174823		1-	A	A3
C 6033	CHIP CAP.	0.01uF	50V	B	GRM188B11H103KA01D	K22174823		1-	A	A2
C 6034	CHIP CAP.	0.01uF	50V	B	GRM188B11H103KA01D	K22174823		1-	A	A2
C 6035	CHIP CAP.	0.01uF	50V	B	GRM188B11H103KA01D	K22174823		1-	A	A1
C 6036	CHIP CAP.	0.01uF	50V	B	GRM188B11H103KA01D	K22174823		1-	A	G3
C 6037	CHIP CAP.	0.01uF	50V	B	GRM188B11H103KA01D	K22174823		1-	A	G1
C 6038	CHIP CAP.	0.01uF	50V	B	GRM188B11H103KA01D	K22174823		1-	A	A2
C 6039	CHIP CAP.	0.01uF	50V	B	GRM188B11H103KA01D	K22174823		1-	A	A3
C 6040	CHIP CAP.	0.01uF	50V	B	GRM188B11H103KA01D	K22174823		1-	A	A3
C 6041	CHIP CAP.	0.01uF	50V	B	GRM188B11H103KA01D	K22174823		1-	A	E1
C 6042	CHIP CAP.	0.01uF	50V	B	GRM188B11H103KA01D	K22174823		1-	A	A3
C 6043	CHIP CAP.	0.01uF	50V	B	GRM188B11H103KA01D	K22174823		1-	A	A3
C 6044	CHIP CAP.	0.01uF	50V	B	GRM188B11H103KA01D	K22174823		1-	A	A3
C 6045	CHIP CAP.	0.01uF	50V	B	GRM188B11H103KA01D	K22174823		1-	A	C2
C 6057	CERAMIC CAP.	10pF	500V	CH	RT-HM60SKCH100D	K26270151		1-	A	C1
C 6058	CERAMIC CAP.	220pF	500V	SL	RT-HM95SKSL221J	K26270061		1-	A	D1
C 6059	CHIP CAP.	0.047uF	25V	F	GRM39F473Z25PT	K22145002		1-	A	C2
C 6060	CHIP CAP.	0.047uF	25V	F	GRM39F473Z25PT	K22145002		1-	A	D2
C 6061	CERAMIC CAP.	220pF	500V	SL	RT-HM95SKSL221J	K26270061		1-	A	D1
C 6069	CHIP CAP.	0.001uF	50V	B	GRM188B11H102KA01D	K22174809		1-	A	E6
C 6070	CHIP CAP.	0.001uF	50V	B	GRM188B11H102KA01D	K22174809		1-	A	E6
C 6071	CHIP CAP.	0.001uF	50V	B	GRM188B11H102KA01D	K22174809		1-	A	E6
C 6072	CHIP CAP.	0.001uF	50V	B	GRM188B11H102KA01D	K22174809		1-	A	E6
C 6073	CHIP CAP.	0.001uF	50V	B	GRM188B11H102KA01D	K22174809		1-	A	E6
C 6074	CHIP CAP.	0.001uF	50V	B	GRM188B11H102KA01D	K22174809		1-	A	E6
C 6075	CHIP CAP.	0.001uF	50V	B	GRM188B11H102KA01D	K22174809		1-	A	E6
C 6076	CHIP CAP.	0.001uF	50V	B	GRM188B11H102KA01D	K22174809		1-	A	D6
C 6077	CHIP CAP.	0.001uF	50V	B	GRM188B11H102KA01D	K22174809		1-	A	D2
C 6078	CHIP CAP.	0.001uF	50V	B	GRM188B11H102KA01D	K22174809		1-	A	C2
C 6079	CHIP CAP.	0.001uF	50V	B	GRM188B11H102KA01D	K22174809		1-	A	C2
C 6080	CHIP CAP.	0.001uF	50V	B	GRM188B11H102KA01D	K22174809		1-	A	C2
C 6081	CHIP CAP.	0.001uF	50V	B	GRM188B11H102KA01D	K22174809		1-	A	C2
C 6082	CHIP CAP.	0.001uF	50V	B	GRM188B11H102KA01D	K22174809		1-	A	C2
C 6083	CHIP CAP.	0.001uF	50V	B	GRM188B11H102KA01D	K22174809		1-	A	C2
D 6001	SURGE ABSORBER				DSA-301LA	Q9000371		1-	A	C1
D 6002	DIODE				SB11-04HP-TR	G2070866		1-	A	A2
D 6003	DIODE				SB11-04HP-TR	G2070866		1-	A	A2
D 6004	DIODE				BAS316	G2070716		1-	A	A2
D 6005	DIODE				BAS316	G2070716		1-	A	A2
D 6006	DIODE				BAS316	G2070716		1-	A	A2
D 6007	DIODE				BAS316	G2070716		1-	A	A2
D 6008	DIODE				BAS316	G2070716		1-	A	A3

TUNER-MAIN Unit

Parts List

REF	DESCRIPTION	VALUE	V/W	TOL.	MFR'S DESIG	VXSTD P/N	VERS.	LOT	SIDE	LAY ADR
D 6009	DIODE				BAS316	G2070716		1-	A	A3
D 6010	DIODE				1SS106	G2090244		1-	A	A3
D 6011	DIODE				1SS106	G2090244		1-	A	A3
D 6018	DIODE				SB11-04HP-TR	G2070866		1-	A	D1
D 6019	DIODE				SB11-04HP-TR	G2070866		1-	A	D1
J 6001	CONNECTOR				S-Q3063#01	P1090295		1-	A	A2
J 6002	CONNECTOR				S-Q3063#01	P1090295		1-	A	E3
J 6003	CONNECTOR				S-Q3063#01	P1090295		1-	A	D1
J 6009	CONNECTOR				SC25-03WS	P0090622		1-	A	D2
J 6010	CONNECTOR				S-Q3063#01	P1090295		1-	A	B2
JP6001	WIRE ASSY				AH010H	T9207144		1-	A	C2
JP6002	WIRE ASSY				AH010H	T9207145A		1-	A	D6
JP6003	WIRE ASSY				AH010H	T9207146B		1-	A	B3
L 6001	COIL A1				2.5T11D2.0UEW R	L0022471		1-	A	E4
L 6002	COIL A1				2.5T15D2.0PVF R	L0021949		1-	A	E5
L 6003	TOROIDAL COIL				2001F FR9.5	L0022453		1-	A	A1
L 6004	COIL F1				4.5T9.0D2.0PVF R	L0022852		1-	A	F5
L 6005	M.RFC	1mH			LAL03TA102K	L1790119		1-	A	A1
L 6006	COIL A1				4.5T15D2.0PVF R	L0021950		1-	A	F5
L 6007	COIL F1				6.5T20D2.0PVF R	L0022851		1-	A	F4
L 6008	COIL A1				9.5T19D2.0PVF R	L0021952		1-	A	F3
L 6009	TOROIDAL COIL	2.55uH			2.55U T106-2	L0022680		1-	A	G2
L 6010	TOROIDAL COIL	2.55uH			2.55U T106-2	L0022680		1-	A	F2
L 6011	TOROIDAL COIL	2.55uH			2.55U T106-2	L0022680		1-	A	F2
L 6012	M.RFC	22uH			LAP02TA220K	L1790062		1-	A	A2
L 6018	M.RFC	1mH			LAL03NA102K	L1190189		1-	A	C2
L 6019	TOROIDAL COIL	110uH			110U R19.3-4.8-5	L0021859		1-	A	D1
L 6020	M.RFC	1mH			LAL03NA102K	L1190189		1-	A	D2
MO6001	STEPPING MOTOR				MP24GA(250-OHM)	M2190023		1-		
MO6002	STEPPING MOTOR				MP24GA(250-OHM)	M2190023		1-		
P 6003	WIRE ASSY				GRA 130 PINL/PINL	T9318156		1-		
Q 6001	FET				2SK210-GR(TE85R.F)	G3802107G		1-	A	A1
Q 6002	FET				2SK210-GR(TE85R.F)	G3802107G		1-	A	A1
Q 6003	TRANSISTOR				2SC2620QBTR	G3326207B		1-	A	A2
Q 6004	TRANSISTOR				2SC2620QBTR	G3326207B		1-	A	A2
Q 6005	IC				NJM2904M-TE2	G1093091		1-	A	A3
Q 6006	IC				TC74AC08F TP2	G1091283		1-	A	A2
Q 6007	IC				TC74AC112F(EL)	G1093667		1-	A	A2
R 6001	CHIP RES.	22	1/2W	5%	RMC1/2 220JCTP	J24275220		1-	A	A2
R 6002	CHIP RES.	150	1/16W	5%	RMC1/16 151JATP	J24185151		1-	A	A1
R 6003	CHIP RES.	100k	1/16W	5%	RMC1/16 104JATP	J24185104		1-	A	A1
R 6004	CHIP RES.	10k	1/16W	5%	RMC1/16 103JATP	J24185103		1-	A	A2
R 6005	CHIP RES.	10k	1/16W	5%	RMC1/16 103JATP	J24185103		1-	A	A2
R 6006	CHIP RES.	100k	1/16W	5%	RMC1/16 104JATP	J24185104		1-	A	A1
R 6007	CHIP RES.	1.5k	1/16W	5%	RMC1/16 152JATP	J24185152		1-	A	A1
R 6008	CHIP RES.	1.5k	1/16W	5%	RMC1/16 152JATP	J24185152		1-	A	A1
R 6009	CHIP RES.	33k	1/16W	5%	RMC1/16 333JATP	J24185333		1-	A	A2
R 6010	CHIP RES.	33k	1/16W	5%	RMC1/16 333JATP	J24185333		1-	A	A2
R 6011	CHIP RES.	1.5k	1/16W	5%	RMC1/16 152JATP	J24185152		1-	A	A2
R 6012	CHIP RES.	1.5k	1/16W	5%	RMC1/16 152JATP	J24185152		1-	A	A2
R 6013	CHIP RES.	100k	1/16W	5%	RMC1/16 104JATP	J24185104		1-	A	A3
R 6014	CHIP RES.	100k	1/16W	5%	RMC1/16 104JATP	J24185104		1-	A	A2
R 6015	CHIP RES.	120k	1/16W	5%	RMC1/16 124JATP	J24185124		1-	A	A3
R 6016	CHIP RES.	120k	1/16W	5%	RMC1/16 124JATP	J24185124		1-	A	A3
R 6017	CHIP RES.	100k	1/16W	5%	RMC1/16 104JATP	J24185104		1-	A	A2
R 6018	CHIP RES.	120k	1/16W	5%	RMC1/16 124JATP	J24185124		1-	A	A2
R 6019	CHIP RES.	100k	1/16W	5%	RMC1/16 104JATP	J24185104		1-	A	A2
R 6020	CHIP RES.	120k	1/16W	5%	RMC1/16 124JATP	J24185124		1-	A	A2
R 6021	CHIP RES.	1k	1/16W	5%	RMC1/16 102JATP	J24185102		1-	A	A3
R 6022	CHIP RES.	1k	1/16W	5%	RMC1/16 102JATP	J24185102		1-	A	A3
R 6023	CHIP RES.	220	1/16W	5%	RMC1/16 221JATP	J24185221		1-	A	A3
R 6024	CHIP RES.	220	1/16W	5%	RMC1/16 221JATP	J24185221		1-	A	A3
R 6025	CHIP RES.	4.7k	1/16W	5%	RMC1/16 472JATP	J24185472		1-	A	A3
R 6026	CHIP RES.	4.7k	1/16W	5%	RMC1/16 472JATP	J24185472		1-	A	A3
R 6027	CHIP RES.	1k	1/16W	5%	RMC1/16 102JATP	J24185102		1-	A	A3
R 6028	CHIP RES.	1k	1/16W	5%	RMC1/16 102JATP	J24185102		1-	A	A3
R 6036	CHIP RES.	0	1/16W	5%	RMC1/16 000JATP	J24185000		1-	A	C2
R 6037	CHIP RES.	47	1W	5%	RMC1 470JTE	J24305470		1-	A	D1
R 6038	CHIP RES.	10k	1/16W	5%	RMC1/16 103JATP	J24185103		1-	A	C2
R 6039	CHIP RES.	47	1W	5%	RMC1 470JTE	J24305470		1-	A	D1
R 6040	CHIP RES.	10k	1/16W	5%	RMC1/16 103JATP	J24185103		1-	A	D2
R 6041	CHIP RES.	0	1/16W	5%	RMC1/16 000JATP	J24185000		1-	A	D2
RL6001	RELAY		DC12V		AJQ8341 DC12V	M1190115		1-	A	B2

TUNER-MAIN Unit

Parts List

REF	DESCRIPTION	VALUE	V/W	TOL.	MFR'S DESIG	VXSTD P/N	VERS.	LOT	SIDE	LAY ADR
RL6003	RELAY		DC12V		AJQ8341 DC12V	M1190115		1-	A	C2
RL6004	RELAY		DC12V		AJQ8341 DC12V	M1190115		1-	A	C2
RL6005	RELAY		DC12V		AJQ8341 DC12V	M1190115		1-	A	C2
RL6007	RELAY		DC12V		AJQ8341 DC12V	M1190115		1-	A	D2
RL6008	RELAY		DC12V		AJQ8341 DC12V	M1190115		1-	A	D2
RL6009	RELAY		DC12V		AJQ8341 DC12V	M1190115		1-	A	E2
RL6010	RELAY		DC12V		G2R-1-E DC12V	M1190141		1-	A	D5
RL6011	RELAY		DC12V		AJQ8341 DC12V	M1190115		1-	A	E2
RL6012	RELAY		DC12V		AJQ8341 DC12V	M1190115		1-	A	E5
RL6014	RELAY		DC12V		AJQ8341 DC12V	M1190115		1-	A	F6
RL6015	RELAY		DC12V		AJQ8341 DC12V	M1190115		1-	A	G5
RL6016	RELAY		DC12V		AJQ8341 DC12V	M1190115		1-	A	G4
RL6017	RELAY		DC12V		AJQ8341 DC12V	M1190115		1-	A	G3
RL6018	RELAY		DC12V		AJQ8341 DC12V	M1190115		1-	A	G1
RL6019	RELAY		DC12V		AJQ8341 DC12V	M1190115		1-	A	F1
RL6020	RELAY		DC12V		JS-12-K DC12V	M1190154		1-	A	B1
RL6021	RELAY		DC12V		JS-12-K DC12V	M1190154		1-	A	B2
TC6001	TRIMMER CAP.	10pF			CVB10-41 10PF	K91000247		1-	A	A1
TC6002	TRIMMER CAP.	20pF			ECV1ZW20X53T 20PF	K91000029		1-	A	D1
TP6001	TERMINAL				TP-K IPS-1136	Q5000050		1-	A	A3
TP6002	TERMINAL				TP-K IPS-1136	Q5000050		1-	A	A3
VC6001	VARIABLE CAP.	125pF			KV-125-05A	K90000052		1-	A	B5
VC6002	VARIABLE CAP.	125pF			KV-125-05A	K90000052		1-	A	C5
	MOTOR HOLDER ASSY					RA0005700		1-		
	UNIVERSAL JOINT				SM-1116-7	S1000009		1-		
	SPACER				3X3	S5000198		1-		
	SHIELD CASE					RA0701300		1-		

TUNER-MAIN Unit

Note:

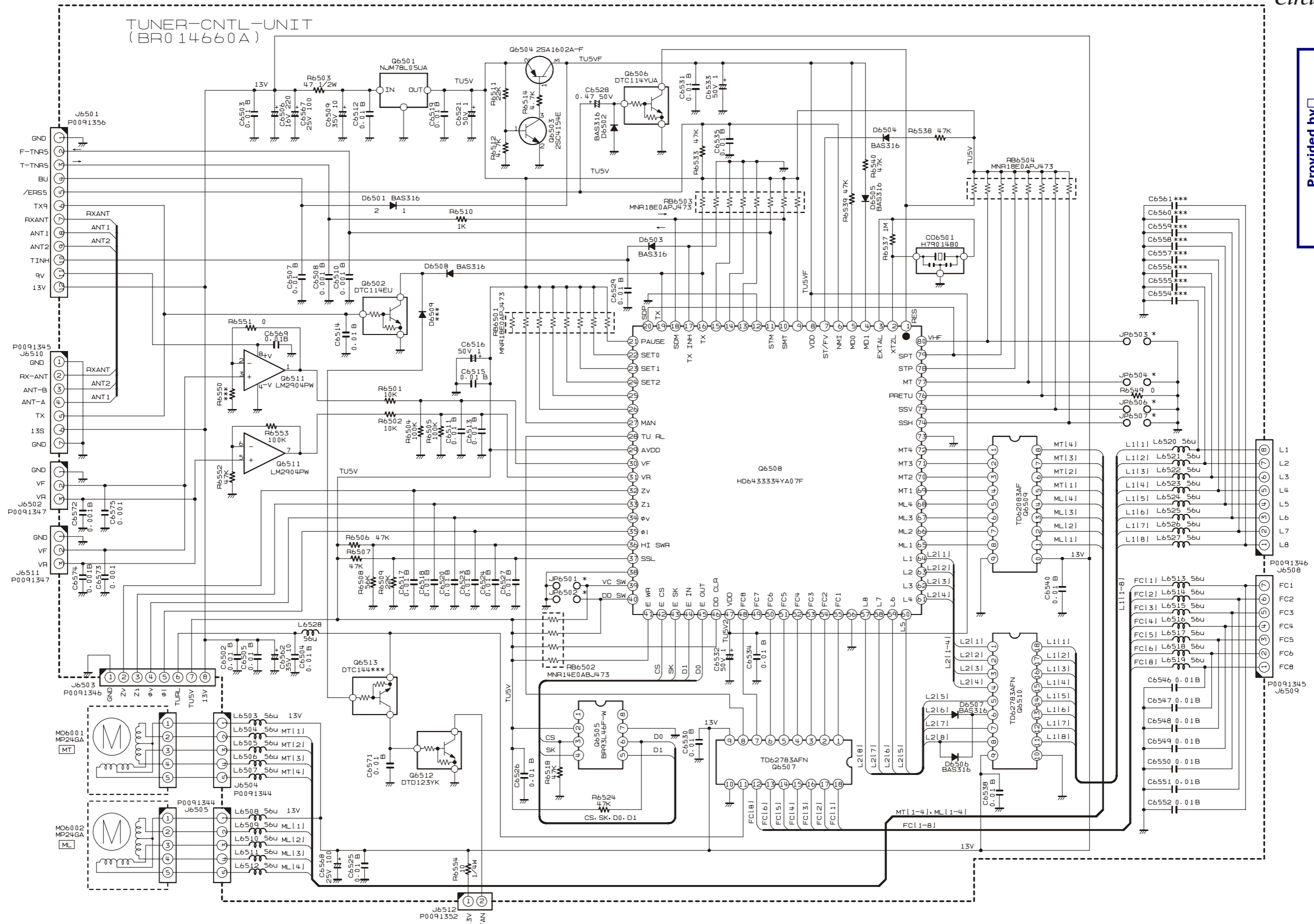

Provided by YAESU museum
Downloaded by RadioAmateur.EU

TUNER-CNTL Unit

Note

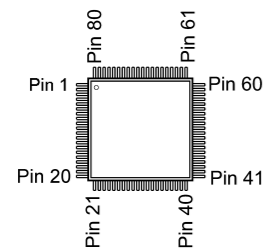

HD643334YA07F
(Q6508)

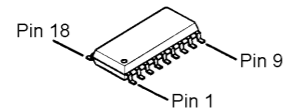

TD62083AF
(Q6509)
TD62783AFN
(Q6507, 6510)

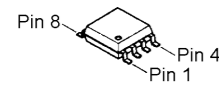

BR93L46F
(Q6505)

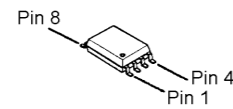

LM2904PWR
(Q6511)

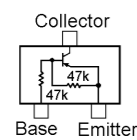

DTA144EE (16)
(Q6513)

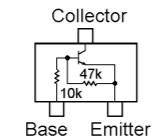

DTC114YUA (64)
(Q6506)

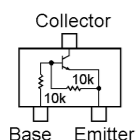

DTC114EU (24)
(Q6502)

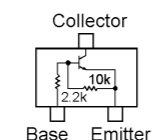

DTD123YK (F62)
(Q6512)

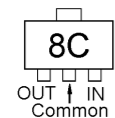

NJM78L05UA (8C)
(Q6501)

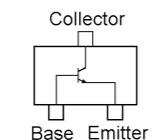

2SC4154E (E)
(Q6503)

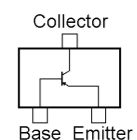

2SA1602A (MF)
(Q6504)

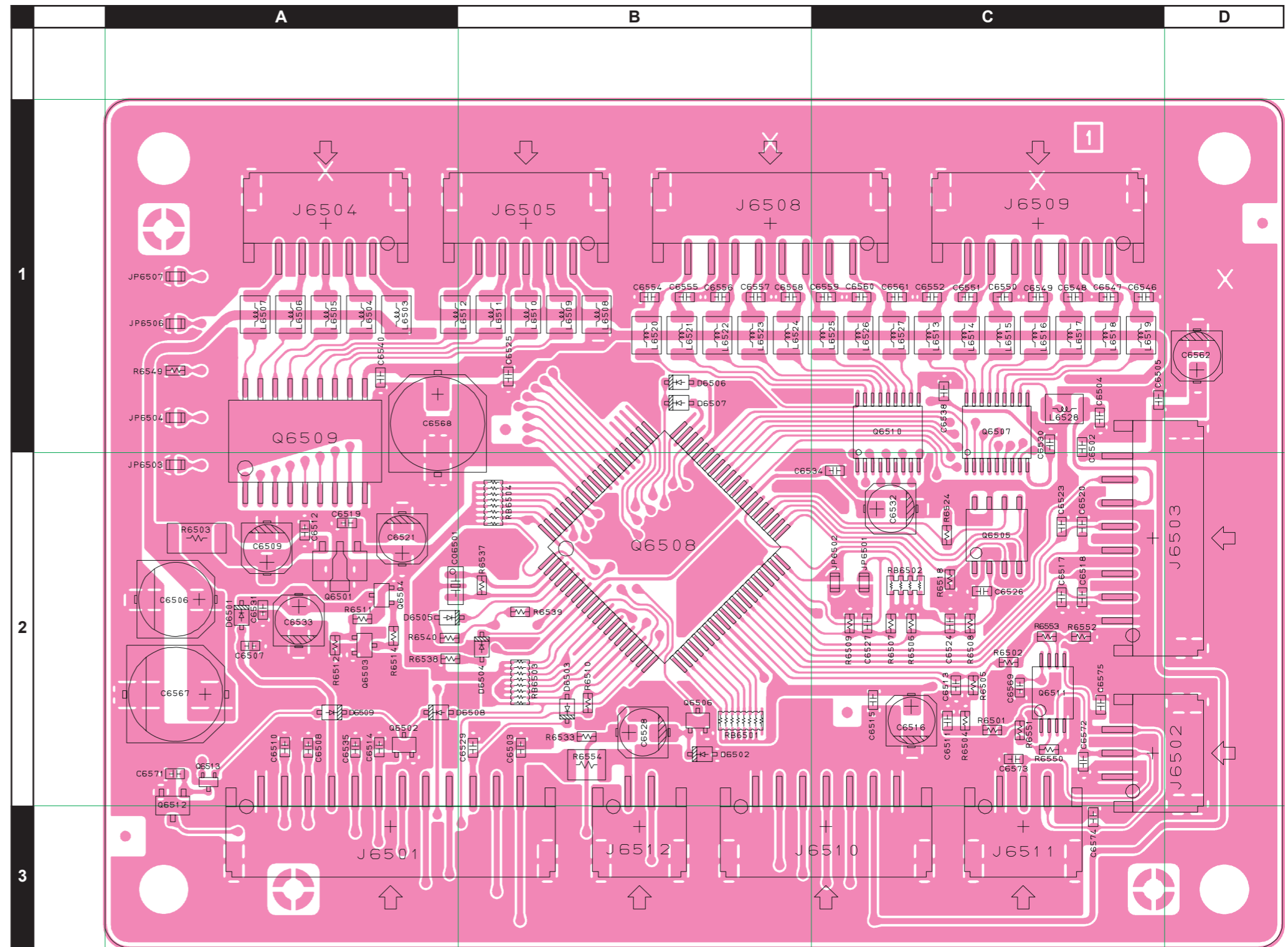

TUNER-CNTL Unit

Parts Layout (Side B)

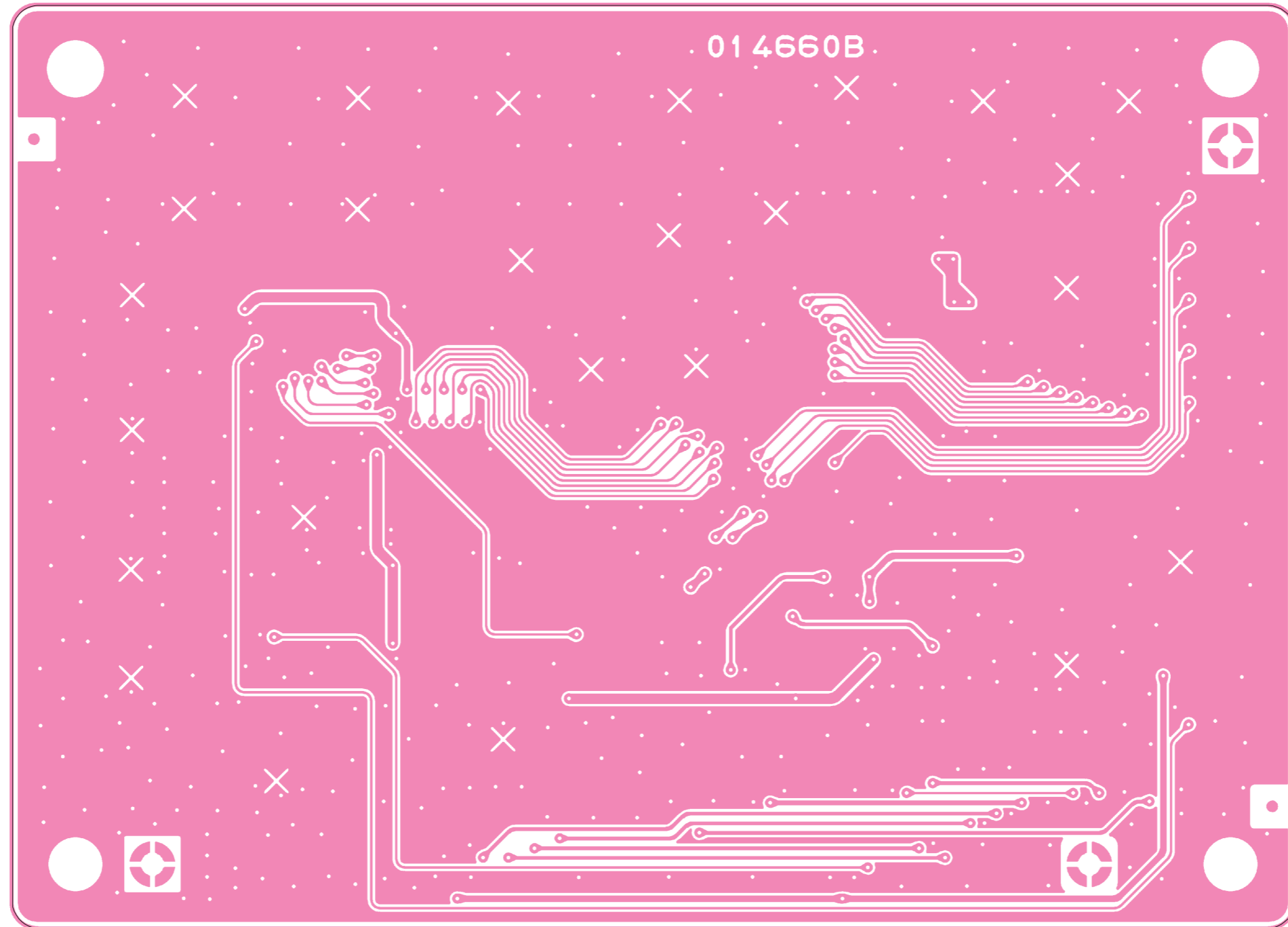

TUNER-CNTL Unit

Parts List



REF	DESCRIPTION	VALUE	V/W	TOL.	MFR'S DESIG	VXSTD P/N	VERS.	LOT	SIDE	LAY ADR	
PCB with Components						CB3490001					
Printed Circuit Board						AH025H000	FR014660B		1-		
C 6502	CHIP CAP.	0.01uF	50V	B	GRM188B11H103KA01D	K22174823		1-	A	C1	
C 6503	CHIP CAP.	0.01uF	50V	B	GRM188B11H103KA01D	K22174823		1-	A	B2	
C 6504	CHIP CAP.	0.01uF	50V	B	GRM188B11H103KA01D	K22174823		1-	A	C1	
C 6505	CHIP CAP.	0.01uF	50V	B	GRM188B11H103KA01D	K22174823		1-	A	C1	
C 6506	AL.ELECTRO.CAP.	220uF	16V		MVA16VC220MF80	K48120021		1-	A	A2	
C 6507	CHIP CAP.	0.01uF	50V	B	GRM188B11H103KA01D	K22174823		1-	A	A2	
C 6508	CHIP CAP.	0.001uF	50V	B	GRM188B11H102KA01D	K22174821		1-	A	A2	
C 6509	AL.ELECTRO.CAP.	10uF	35V		EEE1VA100WR	K48160006		1-	A	A2	
C 6510	CHIP CAP.	0.001uF	50V	B	GRM188B11H102KA01D	K22174821		1-	A	A2	
C 6511	CHIP CAP.	0.01uF	50V	B	GRM188B11H103KA01D	K22174823		1-	A	C2	
C 6512	CHIP CAP.	0.01uF	50V	B	GRM188B11H103KA01D	K22174823		1-	A	A2	
C 6513	CHIP CAP.	0.01uF	50V	B	GRM188B11H103KA01D	K22174823		1-	A	C2	
C 6514	CHIP CAP.	0.01uF	50V	B	GRM188B11H103KA01D	K22174823		1-	A	A2	
C 6515	CHIP CAP.	0.01uF	50V	B	GRM188B11H103KA01D	K22174823		1-	A	C2	
C 6516	AL.ELECTRO.CAP.	1uF	50V		EEE1HA010SR	K48170027		1-	A	C2	
C 6517	CHIP CAP.	0.01uF	50V	B	GRM188B11H103KA01D	K22174823		1-	A	C2	
C 6518	CHIP CAP.	0.01uF	50V	B	GRM188B11H103KA01D	K22174823		1-	A	C2	
C 6519	CHIP CAP.	0.01uF	50V	B	GRM188B11H103KA01D	K22174823		1-	A	A2	
C 6520	CHIP CAP.	0.01uF	50V	B	GRM188B11H103KA01D	K22174823		1-	A	C2	
C 6521	AL.ELECTRO.CAP.	1uF	50V		EEE1HA010SR	K48170027		1-	A	A2	
C 6523	CHIP CAP.	0.01uF	50V	B	GRM188B11H103KA01D	K22174823		1-	A	C2	
C 6524	CHIP CAP.	0.01uF	50V	B	GRM188B11H103KA01D	K22174823		1-	A	C2	
C 6525	CHIP CAP.	0.01uF	50V	B	GRM188B11H103KA01D	K22174823		1-	A	B1	
C 6526	CHIP CAP.	0.01uF	50V	B	GRM188B11H103KA01D	K22174823		1-	A	C2	
C 6527	CHIP CAP.	0.01uF	50V	B	GRM188B11H103KA01D	K22174823		1-	A	C2	
C 6528	AL.ELECTRO.CAP.	0.47uF	50V		EEE1HAR47SR	K48170023		1-	A	B2	
C 6529	CHIP CAP.	0.01uF	50V	B	GRM188B11H103KA01D	K22174823		1-	A	B2	
C 6530	CHIP CAP.	0.01uF	50V	B	GRM188B11H103KA01D	K22174823		1-	A	C1	
C 6531	CHIP CAP.	0.01uF	50V	B	GRM188B11H103KA01D	K22174823		1-	A	A2	
C 6532	AL.ELECTRO.CAP.	1uF	50V		EEE1HA010SR	K48170027		1-	A	C2	
C 6533	AL.ELECTRO.CAP.	1uF	50V		EEE1HA010SR	K48170027		1-	A	A2	
C 6534	CHIP CAP.	0.01uF	50V	B	GRM188B11H103KA01D	K22174823		1-	A	C2	
C 6535	CHIP CAP.	0.01uF	50V	B	GRM188B11H103KA01D	K22174823		1-	A	A2	
C 6538	CHIP CAP.	0.01uF	50V	B	GRM188B11H103KA01D	K22174823		1-	A	C1	
C 6540	CHIP CAP.	0.01uF	50V	B	GRM188B11H103KA01D	K22174823		1-	A	A1	
C 6546	CHIP CAP.	0.01uF	50V	B	GRM188B11H103KA01D	K22174823		1-	A	C1	
C 6547	CHIP CAP.	0.01uF	50V	B	GRM188B11H103KA01D	K22174823		1-	A	C1	
C 6548	CHIP CAP.	0.01uF	50V	B	GRM188B11H103KA01D	K22174823		1-	A	C1	
C 6549	CHIP CAP.	0.01uF	50V	B	GRM188B11H103KA01D	K22174823		1-	A	C1	
C 6550	CHIP CAP.	0.01uF	50V	B	GRM188B11H103KA01D	K22174823		1-	A	C1	
C 6551	CHIP CAP.	0.01uF	50V	B	GRM188B11H103KA01D	K22174823		1-	A	C1	
C 6552	CHIP CAP.	0.01uF	50V	B	GRM188B11H103KA01D	K22174823		1-	A	C1	
C 6562	AL.ELECTRO.CAP.	10uF	35V		EEE1VA100WR	K48160006		1-	A	D1	
C 6567	AL.ELECTRO.CAP.	100uF	25V		EEE1EA101UP	K48140018		1-	A	A2	
C 6568	AL.ELECTRO.CAP.	100uF	25V		EEE1EA101UP	K48140018		1-	A	A1	
C 6569	CHIP CAP.	0.01uF	50V	B	GRM188B11H103KA01D	K22174823		1-	A	C2	
C 6571	CHIP CAP.	0.01uF	50V	B	GRM188B11H103KA01D	K22174823		1-	A	A2	
C 6572	CHIP CAP.	0.001uF	50V	B	GRM188B11H102KA01D	K22174809		1-	A	C2	
C 6573	CHIP CAP.	0.001uF	50V	B	GRM188B11H102KA01D	K22174809		1-	A	C2	
C 6574	CHIP CAP.	0.001uF	50V	B	GRM188B11H102KA01D	K22174809		1-	A	C3	
C 6575	CHIP CAP.	0.001uF	50V	B	GRM188B11H102KA01D	K22174809		1-	A	C2	
CO6501	CERAMIC OSC				CSTCE16M0V53-R0	H7901480		1-	A	A2	
D 6501	DIODE				BAS316	G2070716		1-	A	A2	
D 6502	DIODE				BAS316	G2070716		1-	A	B2	
D 6503	DIODE				BAS316	G2070716		1-	A	B2	
D 6504	DIODE				BAS316	G2070716		1-	A	B2	
D 6505	DIODE				BAS316	G2070716		1-	A	A2	
D 6506	DIODE				BAS316	G2070716		1-	A	B1	
D 6507	DIODE				BAS316	G2070716		1-	A	B1	
D 6508	DIODE				BAS316	G2070716		1-	A	A2	
D 6509	DIODE				BAS316	G2070716		1-	A	A2	
J 6501	CONNECTOR				S12B-PH-SM3-TB	P0091356		1-	A	A3	
J 6502	CONNECTOR				S3B-PH-SM3-TB	P0091347		1-	A	C2	
J 6503	CONNECTOR				S8B-PH-SM3-TB	P0091346		1-	A	C2	
J 6504	CONNECTOR				S5B-PH-SM3-TB	P0091344		1-	A	A1	
J 6505	CONNECTOR				S5B-PH-SM3-TB	P0091344		1-	A	B1	
J 6508	CONNECTOR				S8B-PH-SM3-TB	P0091346		1-	A	B1	
J 6509	CONNECTOR				S7B-PH-SM3-TB	P0091345		1-	A	C1	
J 6510	CONNECTOR				S7B-PH-SM3-TB	P0091345		1-	A	C3	
J 6511	CONNECTOR				S3B-PH-SM3-TB	P0091347		1-	A	C3	
J 6512	CONNECTOR				S2B-PH-SM3-TB	P0091352		1-	A	B3	

TUNER-CNTL Unit

Parts List

REF	DESCRIPTION	VALUE	V/W	TOL.	MFR'S DESIG	VXSTD P/N	VERS.	LOT	SIDE	LAY ADR
L 6503	M.RFC	56uH			LLM3225-560J	L1691142		1-	A	A1
L 6504	M.RFC	56uH			LLM3225-560J	L1691142		1-	A	A1
L 6505	M.RFC	56uH			LLM3225-560J	L1691142		1-	A	A1
L 6506	M.RFC	56uH			LLM3225-560J	L1691142		1-	A	A1
L 6507	M.RFC	56uH			LLM3225-560J	L1691142		1-	A	A1
L 6508	M.RFC	56uH			LLM3225-560J	L1691142		1-	A	B1
L 6509	M.RFC	56uH			LLM3225-560J	L1691142		1-	A	B1
L 6510	M.RFC	56uH			LLM3225-560J	L1691142		1-	A	B1
L 6511	M.RFC	56uH			LLM3225-560J	L1691142		1-	A	B1
L 6512	M.RFC	56uH			LLM3225-560J	L1691142		1-	A	A1
L 6513	M.RFC	56uH			LLM3225-560J	L1691142		1-	A	C1
L 6514	M.RFC	56uH			LLM3225-560J	L1691142		1-	A	C1
L 6515	M.RFC	56uH			LLM3225-560J	L1691142		1-	A	C1
L 6516	M.RFC	56uH			LLM3225-560J	L1691142		1-	A	C1
L 6517	M.RFC	56uH			LLM3225-560J	L1691142		1-	A	C1
L 6518	M.RFC	56uH			LLM3225-560J	L1691142		1-	A	C1
L 6519	M.RFC	56uH			LLM3225-560J	L1691142		1-	A	C1
L 6520	M.RFC	56uH			LLM3225-560J	L1691142		1-	A	B1
L 6521	M.RFC	56uH			LLM3225-560J	L1691142		1-	A	B1
L 6522	M.RFC	56uH			LLM3225-560J	L1691142		1-	A	B1
L 6523	M.RFC	56uH			LLM3225-560J	L1691142		1-	A	B1
L 6524	M.RFC	56uH			LLM3225-560J	L1691142		1-	A	B1
L 6525	M.RFC	56uH			LLM3225-560J	L1691142		1-	A	C1
L 6526	M.RFC	56uH			LLM3225-560J	L1691142		1-	A	C1
L 6527	M.RFC	56uH			LLM3225-560J	L1691142		1-	A	C1
L 6528	M.RFC	56uH			LLM3225-560J	L1691142		1-	A	C1
Q 6501	IC				NJM78L05UA-TE1	G1091325		1-	A	A2
Q 6502	TRANSISTOR				DTC114EUA T106	G3070084		1-	A	A2
Q 6503	TRANSISTOR				2SC4154-T11-1E	G3341548E		1-	A	A2
Q 6504	TRANSISTOR				2SA1602A-T11-1F	G3116028F		1-	A	A2
Q 6505	IC				BR93L46F-WE2	G1093884		1-	A	C2
Q 6506	TRANSISTOR				DTC114YUA T106	G3070298		1-	A	B2
Q 6507	IC				TD62783AFN(EL)	G1092700		1-	A	C1
Q 6508	IC				HD6433334YA07F	G1092665		1-	A	B2
Q 6509	IC				TD62083AF(EL)	G1094247		1-	A	A1
Q 6510	IC				TD62783AFN(EL)	G1092700		1-	A	C1
Q 6511	IC				LM2904PWR	G1094010		1-	A	C2
Q 6512	TRANSISTOR				DTD123YK T146	G3070157		1-	A	A2
Q 6513	TRANSISTOR				DTA144EE TL	G3070074		1-	A	A2
R 6501	CHIP RES.	10k	1/16W	5%	RMC1/16 103JATP	J24185103		1-	A	C2
R 6502	CHIP RES.	10k	1/16W	5%	RMC1/16 103JATP	J24185103		1-	A	C2
R 6503	CHIP RES.	47	1/2W	5%	RMC1/2 470JCTP	J24275470		1-	A	A2
R 6504	CHIP RES.	100k	1/16W	5%	RMC1/16 104JATP	J24185104		1-	A	C2
R 6505	CHIP RES.	100k	1/16W	5%	RMC1/16 104JATP	J24185104		1-	A	C2
R 6506	CHIP RES.	47k	1/16W	5%	RMC1/16 473JATP	J24185473		1-	A	C2
R 6507	CHIP RES.	47k	1/16W	5%	RMC1/16 473JATP	J24185473		1-	A	C2
R 6508	CHIP RES.	56k	1/16W	5%	RMC1/16 563JATP	J24185563		1-	A	C2
R 6509	CHIP RES.	22k	1/16W	5%	RMC1/16 223JATP	J24185223		1-	A	C2
R 6510	CHIP RES.	1k	1/16W	5%	RMC1/16 102JATP	J24185102		1-	A	B2
R 6511	CHIP RES.	22k	1/16W	5%	RMC1/16 223JATP	J24185223		1-	A	A2
R 6512	CHIP RES.	4.7k	1/16W	5%	RMC1/16 472JATP	J24185472		1-	A	A2
R 6514	CHIP RES.	4.7k	1/16W	5%	RMC1/16 472JATP	J24185472		1-	A	A2
R 6518	CHIP RES.	47k	1/16W	5%	RMC1/16 473JATP	J24185473		1-	A	C2
R 6524	CHIP RES.	47k	1/16W	5%	RMC1/16 473JATP	J24185473		1-	A	C2
R 6533	CHIP RES.	47k	1/16W	5%	RMC1/16 473JATP	J24185473		1-	A	B2
R 6537	CHIP RES.	1M	1/16W	5%	RMC1/16 105JATP	J24185105		1-	A	B2
R 6538	CHIP RES.	47k	1/16W	5%	RMC1/16 473JATP	J24185473		1-	A	A2
R 6539	CHIP RES.	47k	1/16W	5%	RMC1/16 473JATP	J24185473		1-	A	B2
R 6540	CHIP RES.	47k	1/16W	5%	RMC1/16 473JATP	J24185473		1-	A	A2
R 6549	CHIP RES.	0	1/16W	5%	RMC1/16 000JATP	J24185000		1-	A	A1
R 6551	CHIP RES.	0	1/16W	5%	RMC1/16 000JATP	J24185000		1-	A	C2
R 6552	CHIP RES.	47k	1/16W	5%	RMC1/16 473JATP	J24185473		1-	A	C2
R 6553	CHIP RES.	100k	1/16W	5%	RMC1/16 104JATP	J24185104		1-	A	C2
R 6554	CHIP RES.	33	1/4W	5%	RMC1/4 330JATP	J24245330		1-	A	B2
RB6501	BLOCK RES.				MNR18E0APJ473	J42900034		1-	A	B2
RB6502	BLOCK RES.				MNR14E0ABJ473	J42900031		1-	A	C2
RB6503	BLOCK RES.				MNR18E0APJ473	J42900034		1-	A	B2
RB6504	BLOCK RES.				MNR18E0APJ473	J42900034		1-	A	B2

DSP Unit Circuit Diagram

Provided by  YAESU museum
Downloaded by  RadioAmateur.EU

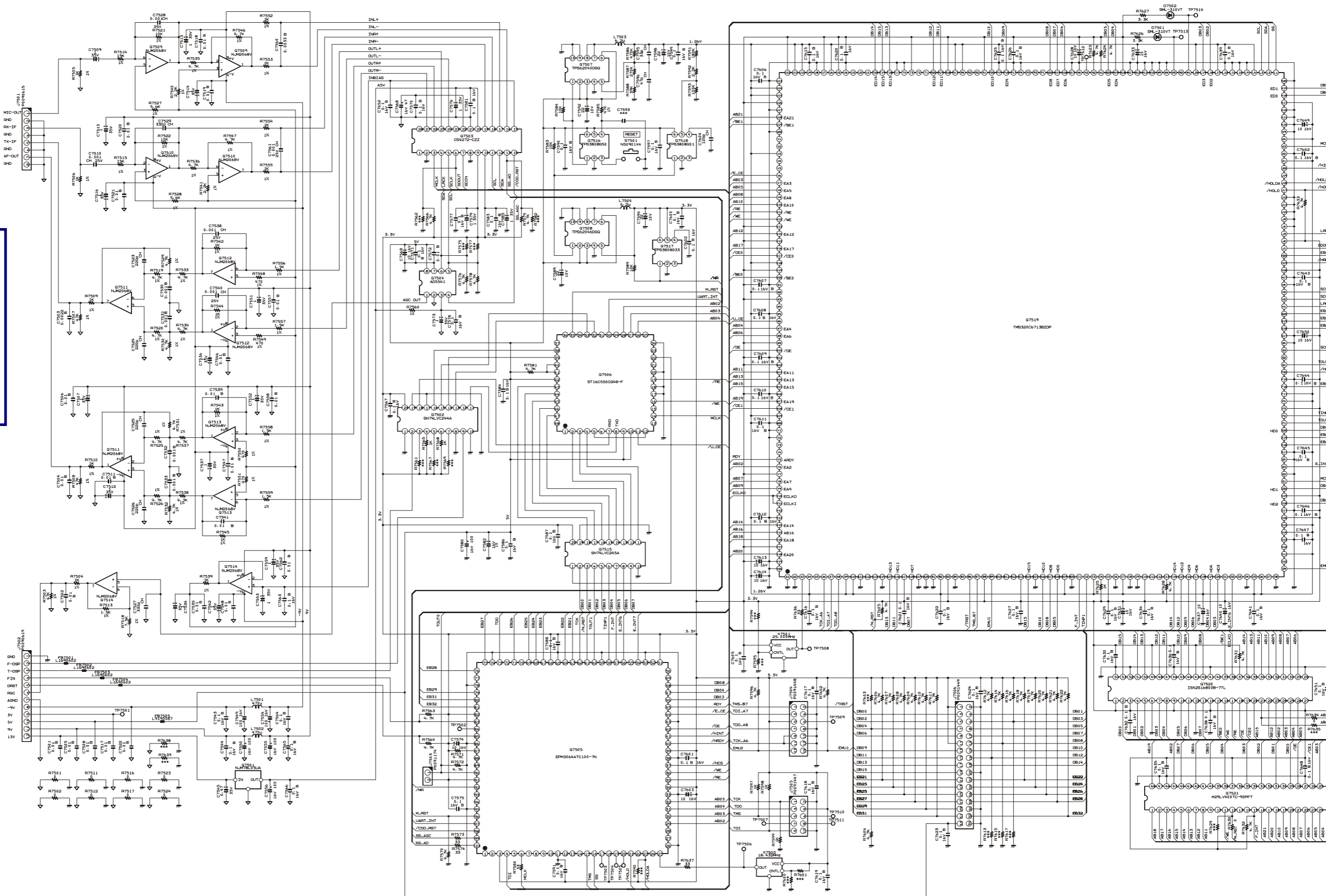

DSP Unit

Note

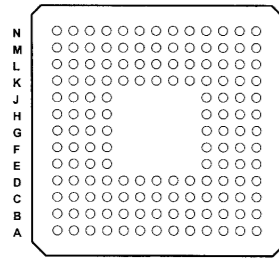
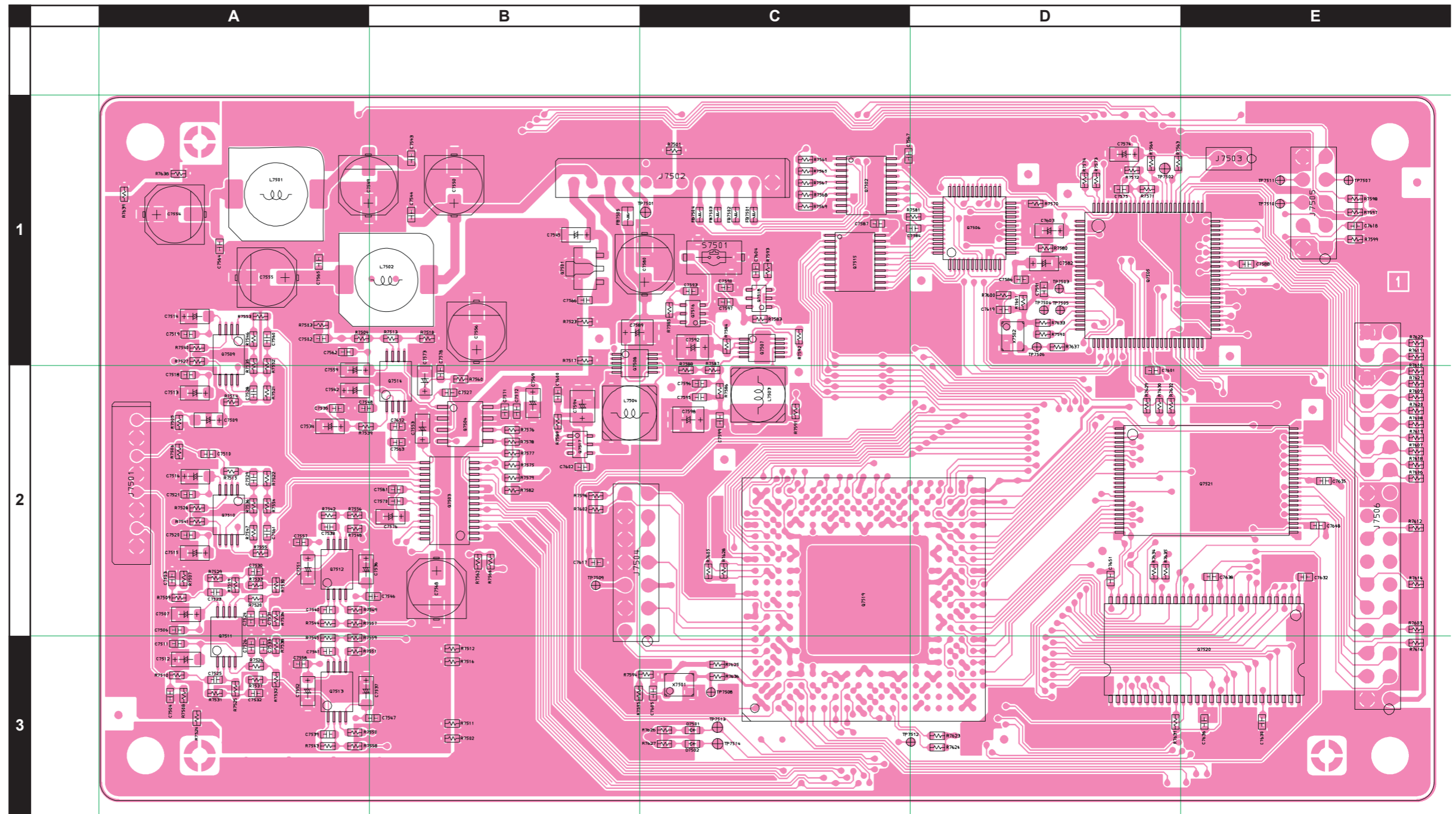

Bottom View
TMS320C6713BZDP
(Q7519)

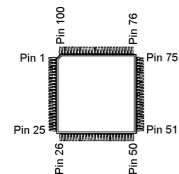

EPM3064ATC100
(Q7505)

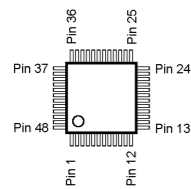

ST16C550CQ48-F
(Q7506)

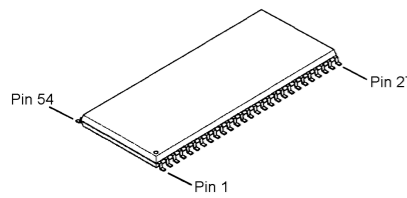

IS42S16800B
(Q7520)

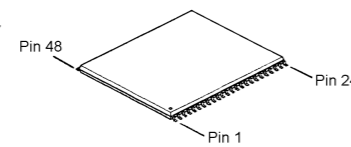

M29LV400TC
(Q7521)

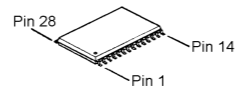

CS4272
(Q7503)

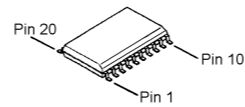

SN74LVC244PWR
(Q7502)

SN74LVC245PWR
(Q7502)

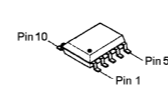

TPS62040DGQ
(Q7507)

TPS62046DGQ
(Q7508)

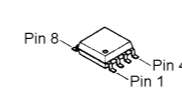

AD5541JR
(Q7504)

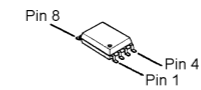

NJM2068V
(Q7509, 7510, 7511,
7512, 7513, 7514)

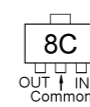

NJM75L05UA (8C)
(Q7501)

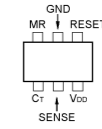

TPS3808G01
(Q7518)
TPS3808G33
(Q7517)
TPS3808G50
(Q7516)
TPS3808G33
(Q7517)

DSP Unit

Parts Layout (Side B)

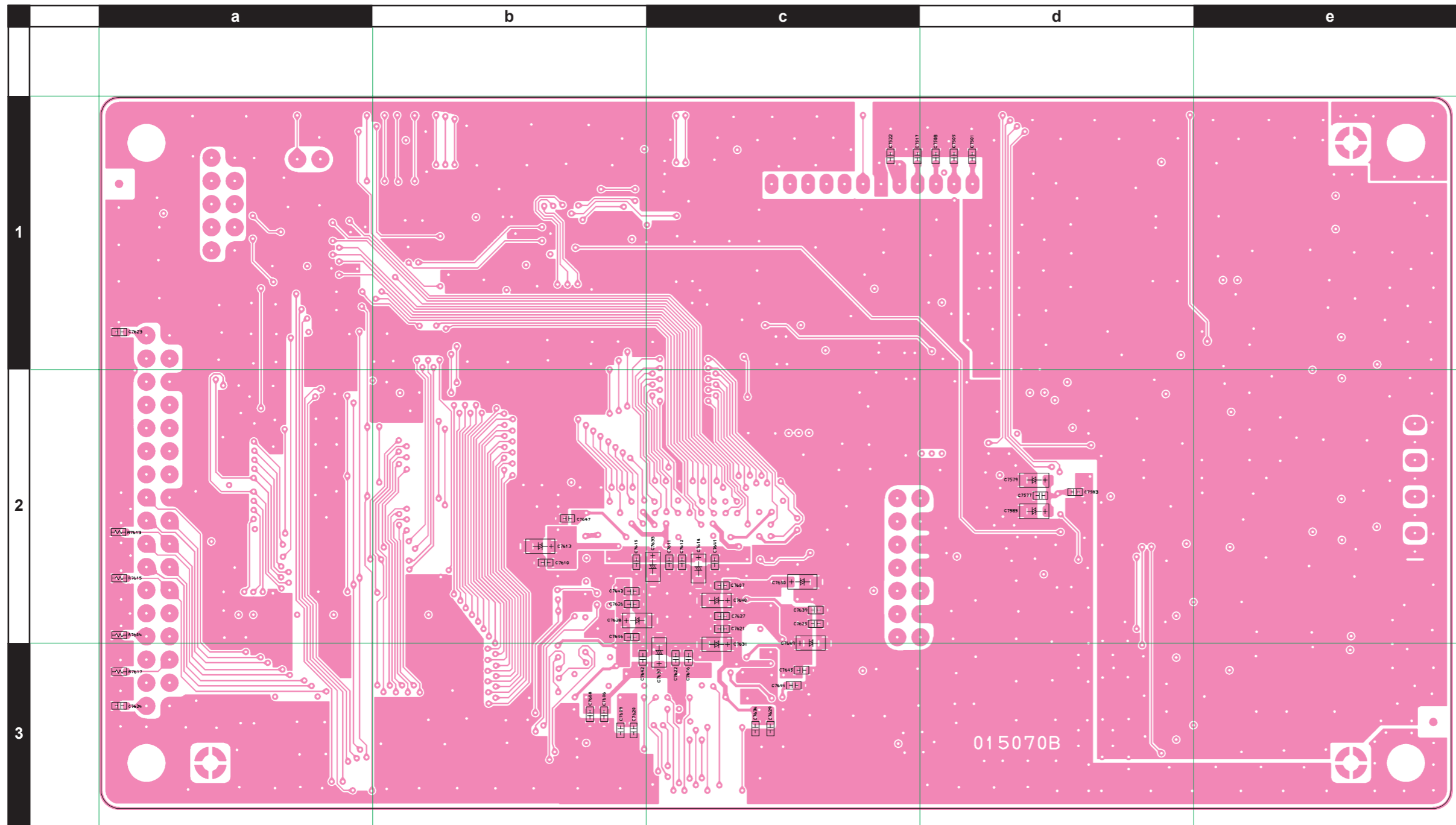

DSP Unit

Parts List

REF	DESCRIPTION	VALUE	V/W	TOL.	MFR'S DESIG	VXSTD P/N	VERS.	LOT	SIDE	LAY	ADR
PCB with Components						CS1894001					
	Printed Circuit Board				AH025H000	FR015070B			1-		
C 7501	CHIP CAP.	0.01uF	50V	B	GRM188B11H103KA01D	K22174823		1-	B		d1
C 7502	CHIP CAP.	0.01uF	50V	B	GRM188B11H103JA01D	K22174824		1-	A		A1
C 7503	CHIP CAP.	0.0022uF	50V	B	GRM188B11H222KA01D	K22174822		1-	A		A2
C 7504	CHIP CAP.	0.01uF	50V	B	GRM188B11H103JA01D	K22174824		1-	A		A3
C 7505	CHIP CAP.	0.01uF	50V	B	GRM188B11H103KA01D	K22174823		1-	B		d1
C 7506	CHIP CAP.	0.01uF	50V	B	GRM188B11H103KA01D	K22174823		1-	A		A2
C 7507	CHIP TA.CAP.	1uF	35V		TEMSVA1V105M-8R	K78160032		1-	A		A2
C 7508	CHIP CAP.	0.01uF	50V	B	GRM188B11H103KA01D	K22174823		1-	B		d1
C 7509	CHIP TA.CAP.	1uF	35V		TEMSVA1V105M-8R	K78160032		1-	A		A2
C 7510	CHIP CAP.	0.001uF	25V	CH	GRM1882C1E102JA01D	K22144204		1-	A		A2
C 7511	CHIP CAP.	0.01uF	50V	B	GRM188B11H103KA01D	K22174823		1-	A		A3
C 7512	CHIP TA.CAP.	1uF	35V		TEMSVA1V105M-8R	K78160032		1-	A		A3
C 7513	CHIP TA.CAP.	1uF	35V		TEMSVA1V105M-8R	K78160032		1-	A		A2
C 7514	CHIP TA.CAP.	1uF	35V		TEMSVA1V105M-8R	K78160032		1-	A		A1
C 7515	CHIP TA.CAP.	1uF	35V		TEMSVA1V105M-8R	K78160032		1-	A		A2
C 7516	CHIP TA.CAP.	1uF	35V		TEMSVA1V105M-8R	K78160032		1-	A		A2
C 7517	CHIP CAP.	0.01uF	50V	B	GRM188B11H103KA01D	K22174823		1-	B		c1
C 7518	CHIP CAP.	0.01uF	50V	B	GRM188B11H103KA01D	K22174823		1-	A		A2
C 7519	CHIP CAP.	0.01uF	50V	B	GRM188B11H103KA01D	K22174823		1-	A		A1
C 7520	CHIP CAP.	0.01uF	50V	B	GRM188B11H103KA01D	K22174823		1-	A		A2
C 7521	CHIP CAP.	0.01uF	50V	B	GRM188B11H103KA01D	K22174823		1-	A		A2
C 7522	CHIP CAP.	0.01uF	50V	B	GRM188B11H103KA01D	K22174823		1-	B		c1
C 7523	CHIP CAP.	220pF	50V	CH	GRM1882C1H221JA01D	K22174243		1-	A		A2
C 7524	CHIP CAP.	220pF	50V	CH	GRM1882C1H221JA01D	K22174243		1-	A		A2
C 7525	CHIP CAP.	220pF	50V	CH	GRM1882C1H221JA01D	K22174243		1-	A		A3
C 7526	CHIP CAP.	220pF	50V	CH	GRM1882C1H221JA01D	K22174243		1-	A		A3
C 7527	CHIP CAP.	330pF	50V	CH	GRM1882C1H331JA01D	K22174253		1-	A		B2
C 7528	CHIP CAP.	0.001uF	25V	CH	GRM1882C1E102JA01D	K22144204		1-	A		A2
C 7529	CHIP CAP.	330pF	50V	CH	GRM1882C1H331JA01D	K22174253		1-	A		A2
C 7530	CHIP CAP.	0.001uF	50V	B	GRM188B11H102KA01D	K22174821		1-	A		A2
C 7531	CHIP CAP.	0.001uF	50V	B	GRM188B11H102KA01D	K22174821		1-	A		A2
C 7532	CHIP CAP.	0.001uF	50V	B	GRM188B11H102KA01D	K22174821		1-	A		A3
C 7533	CHIP CAP.	0.001uF	50V	B	GRM188B11H102KA01D	K22174821		1-	A		A3
C 7534	CHIP TA.CAP.	1uF	35V		TEMSVA1V105M-8R	K78160032		1-	A		A2
C 7535	CHIP CAP.	0.01uF	50V	B	GRM188B11H103KA01D	K22174823		1-	A		A2
C 7536	CHIP TA.CAP.	1uF	35V		TEMSVA1V105M-8R	K78160032		1-	A		A2
C 7537	CHIP TA.CAP.	1uF	35V		TEMSVA1V105M-8R	K78160032		1-	A		A3
C 7538	CHIP CAP.	0.001uF	25V	CH	GRM1882C1E102JA01D	K22144204		1-	A		A2
C 7539	CHIP CAP.	0.01uF	50V	B	GRM188B11H103JA01D	K22174824		1-	A		A3
C 7540	CHIP CAP.	0.001uF	25V	CH	GRM1882C1E102JA01D	K22144204		1-	A		A2
C 7541	CHIP CAP.	0.01uF	50V	B	GRM188B11H103JA01D	K22174824		1-	A		A3
C 7542	CHIP TA.CAP.	1uF	35V		TEMSVA1V105M-8R	K78160032		1-	A		A2
C 7543	CHIP CAP.	0.1uF	16V	B	GRM188B11C104KA01D	K22124805		1-	A		B1
C 7544	CHIP CAP.	0.1uF	16V	B	GRM188B11C104KA01D	K22124805		1-	A		B1
C 7545	CHIP TA.CAP.	0.47uF	35V		TEMSVA1V474M-8R	K78160029		1-	A		B1
C 7546	CHIP CAP.	0.01uF	50V	B	GRM188B11H103KA01D	K22174823		1-	A		B2
C 7547	CHIP CAP.	0.01uF	50V	B	GRM188B11H103KA01D	K22174823		1-	A		B3
C 7548	CHIP CAP.	0.01uF	50V	B	GRM188B11H103KA01D	K22174823		1-	A		A2
C 7549	AL.ELECTRO.CAP.	100uF	16V		EEE1CA101WP	K48120012		1-	A		A1
C 7550	AL.ELECTRO.CAP.	100uF	16V		EEE1CA101WP	K48120012		1-	A		B1
C 7551	CHIP TA.CAP.	1uF	35V		TEMSVA1V105M-8R	K78160032		1-	A		A2
C 7552	CHIP TA.CAP.	1uF	35V		TEMSVA1V105M-8R	K78160032		1-	A		A3
C 7553	CHIP TA.CAP.	1uF	35V		TEMSVA1V105M-8R	K78160032		1-	A		B2
C 7554	AL.ELECTRO.CAP.	100uF	16V		EEE1CA101WP	K48120012		1-	A		A1
C 7555	AL.ELECTRO.CAP.	100uF	16V		EEE1CA101WP	K48120012		1-	A		A1
C 7556	AL.ELECTRO.CAP.	100uF	16V		EEE1CA101WP	K48120012		1-	A		B1
C 7557	CHIP CAP.	0.01uF	50V	B	GRM188B11H103KA01D	K22174823		1-	A		A2
C 7558	CHIP CAP.	0.01uF	50V	B	GRM188B11H103KA01D	K22174823		1-	A		A3
C 7559	CHIP TA.CAP.	1uF	35V		TEMSVA1V105M-8R	K78160032		1-	A		A2
C 7560	CHIP CAP.	0.0033uF	50V	B	GRM188B11H332KA01D	K22174815		1-	A		A1
C 7561	CHIP CAP.	0.001uF	25V	CH	GRM1882C1E102JA01D	K22144204		1-	A		A2
C 7562	CHIP CAP.	0.01uF	50V	B	GRM188B11H103KA01D	K22174823		1-	A		A1
C 7563	CHIP CAP.	0.1uF	16V	B	GRM188B11C104KA01D	K22124805		1-	A		B2
C 7564	CHIP CAP.	0.1uF	16V	B	GRM188B11C104KA01D	K22124805		1-	A		A1
C 7565	CHIP CAP.	0.1uF	16V	B	GRM188B11C104KA01D	K22124805		1-	A		A1
C 7566	CHIP CAP.	0.1uF	16V	B	GRM188B11C104KA01D	K22124805		1-	A		B1
C 7567	CHIP CAP.	0.1uF	16V	B	GRM188B11C104KA01D	K22124805		1-	A		C1
C 7568	AL.ELECTRO.CAP.	47uF	16V		EEE1CA470SP	K48120005		1-	A		B2
C 7569	CHIP TA.CAP.	10uF	16V		TEESVA1C106M8R	K78120077		1-	A		B2
C 7570	CHIP CAP.	0.1uF	16V	B	GRM188B11C104KA01D	K22124805		1-	A		B2
C 7571	CHIP CAP.	0.1uF	16V	B	GRM188B11C104KA01D	K22124805		1-	A		B2

DSP Unit

Parts List

REF	DESCRIPTION	VALUE	V/W	TOL.	MFR'S DESIG	VXSTD P/N	VERS.	LOT	SIDE	LAY ADR
C 7572	CHIP CAP.	0.01uF	50V	B	GRM188B11H103KA01D	K22174823		1-	A	B2
C 7573	CHIP TA.CAP.	1uF	35V		TEMSVA1V105M-8R	K78160032		1-	A	B2
C 7574	CHIP TA.CAP.	10uF	16V		TEESVA1C106M8R	K78120077		1-	A	D1
C 7575	CHIP CAP.	0.1uF	16V	B	GRM188B11C104KA01D	K22124805		1-	A	D1
C 7576	CHIP TA.CAP.	1uF	35V		TEMSVA1V105M-8R	K78160032		1-	A	B2
C 7577	CHIP CAP.	0.1uF	16V	B	GRM188B11C104KA01D	K22124805		1-	B	d2
C 7578	CHIP CAP.	0.1uF	16V	B	GRM188B11C104KA01D	K22124805		1-	A	B2
C 7579	CHIP TA.CAP.	1uF	35V		TEMSVA1V105M-8R	K78160032		1-	B	d2
C 7580	AL.ELECTRO.CAP.	100uF	16V		EEE1CA101WP	K48120012		1-	A	C1
C 7581	CHIP CAP.	0.1uF	16V	B	GRM188B11C104KA01D	K22124805		1-	A	B2
C 7582	CHIP TA.CAP.	10uF	16V		TEESVA1C106M8R	K78120077		1-	A	D1
C 7583	CHIP CAP.	0.1uF	16V	B	GRM188B11C104KA01D	K22124805		1-	B	d2
C 7584	CHIP CAP.	0.1uF	16V	B	GRM188B11C104KA01D	K22124805		1-	A	D1
C 7585	CHIP TA.CAP.	1uF	35V		TEMSVA1V105M-8R	K78160032		1-	B	d2
C 7586	CHIP CAP.	0.1uF	16V	B	GRM188B11C104KA01D	K22124805		1-	A	D1
C 7587	CHIP CAP.	0.1uF	16V	B	GRM188B11C104KA01D	K22124805		1-	A	C1
C 7588	CHIP CAP.	0.1uF	16V	B	GRM188B11C104KA01D	K22124805		1-	A	E1
C 7589	CHIP TA.CAP.	22uF	10V		TEMSVB21A226M-8R	K78100029		1-	A	B1
C 7590	CHIP CAP.	0.1uF	16V	B	GRM188B11C104KA01D	K22124805		1-	A	C1
C 7591	CHIP CAP.	0.1uF	16V	B	GRM188B11C104KA01D	K22124805		1-	A	D1
C 7592	CHIP TA.CAP.	22uF	10V		TEMSVB21A226M-8R	K78100029		1-	A	C1
C 7594	CHIP TA.CAP.	22uF	10V		TEMSVB21A226M-8R	K78100029		1-	A	B2
C 7595	CHIP CAP.	33pF	50V	CH	GRM1882C1H330JA01D	K22174223		1-	A	C2
C 7596	CHIP CAP.	47pF	50V	CH	GRM1882C1H470JA01D	K22174227		1-	A	C2
C 7597	CHIP CAP.	0.1uF	16V	B	GRM188B11C104KA01D	K22124805		1-	A	C1
C 7598	CHIP TA.CAP.	22uF	10V		TEMSVB21A226M-8R	K78100029		1-	A	C2
C 7599	CHIP CAP.	0.1uF	16V	B	GRM188B11C104KA01D	K22124805		1-	A	C2
C 7600	CHIP CAP.	0.1uF	16V	B	GRM188B11C104KA01D	K22124805		1-	A	B2
C 7601	CHIP CAP.	0.1uF	16V	B	GRM188B11C104KA01D	K22124805		1-	A	D2
C 7602	CHIP CAP.	0.1uF	16V	B	GRM188B11C104KA01D	K22124805		1-	A	B2
C 7603	CHIP TA.CAP.	10uF	16V		TEESVA1C106M8R	K78120077		1-	A	D1
C 7604	CHIP CAP.	120pF	50V	CH	GRM1882C1H121JA01D	K22174237		1-	A	C1
C 7605	CHIP CAP.	0.1uF	16V	B	GRM188B11C104KA01D	K22124805		1-	A	C3
C 7606	CHIP CAP.	0.1uF	16V	B	GRM188B11C104KA01D	K22124805		1-	B	b3
C 7607	CHIP CAP.	0.1uF	16V	B	GRM188B11C104KA01D	K22124805		1-	B	c2
C 7608	CHIP CAP.	0.1uF	16V	B	GRM188B11C104KA01D	K22124805		1-	B	b3
C 7609	CHIP CAP.	0.1uF	16V	B	GRM188B11C104KA01D	K22124805		1-	B	b3
C 7610	CHIP CAP.	0.1uF	16V	B	GRM188B11C104KA01D	K22124805		1-	B	b2
C 7611	CHIP CAP.	0.1uF	16V	B	GRM188B11C104KA01D	K22124805		1-	B	c2
C 7612	CHIP CAP.	0.1uF	16V	B	GRM188B11C104KA01D	K22124805		1-	B	c2
C 7613	CHIP TA.CAP.	10uF	16V		TEESVA1C106M8R	K78120077		1-	B	b2
C 7614	CHIP TA.CAP.	10uF	16V		TEESVA1C106M8R	K78120077		1-	B	c2
C 7615	CHIP CAP.	0.1uF	16V	B	GRM188B11C104KA01D	K22124805		1-	B	b2
C 7616	CHIP CAP.	0.1uF	16V	B	GRM188B11C104KA01D	K22124805		1-	B	c3
C 7617	CHIP CAP.	0.1uF	16V	B	GRM188B11C104KA01D	K22124805		1-	A	B2
C 7618	CHIP CAP.	0.1uF	16V	B	GRM188B11C104KA01D	K22124805		1-	A	E1
C 7619	CHIP CAP.	0.1uF	16V	B	GRM188B11C104KA01D	K22124805		1-	A	D1
C 7620	CHIP CAP.	0.1uF	16V	B	GRM188B11C104KA01D	K22124805		1-	B	b3
C 7621	CHIP CAP.	0.1uF	16V	B	GRM188B11C104KA01D	K22124805		1-	B	c2
C 7622	CHIP CAP.	0.1uF	16V	B	GRM188B11C104KA01D	K22124805		1-	B	c3
C 7623	CHIP CAP.	0.1uF	16V	B	GRM188B11C104KA01D	K22124805		1-	B	a1
C 7624	CHIP CAP.	0.1uF	16V	B	GRM188B11C104KA01D	K22124805		1-	B	a3
C 7625	CHIP CAP.	0.1uF	16V	B	GRM188B11C104KA01D	K22124805		1-	B	c2
C 7626	CHIP CAP.	0.1uF	16V	B	GRM188B11C104KA01D	K22124805		1-	B	b2
C 7627	CHIP CAP.	0.1uF	16V	B	GRM188B11C104KA01D	K22124805		1-	B	c2
C 7628	CHIP TA.CAP.	10uF	16V		TEESVA1C106M8R	K78120077		1-	B	b2
C 7629	CHIP CAP.	0.1uF	16V	B	GRM188B11C104KA01D	K22124805		1-	B	c3
C 7630	CHIP CAP.	0.1uF	16V	B	GRM188B11C104KA01D	K22124805		1-	A	E3
C 7631	CHIP TA.CAP.	10uF	16V		TEESVA1C106M8R	K78120077		1-	B	c3
C 7632	CHIP CAP.	0.1uF	16V	B	GRM188B11C104KA01D	K22124805		1-	A	E2
C 7633	CHIP TA.CAP.	10uF	16V		TEESVA1C106M8R	K78120077		1-	B	c2
C 7634	CHIP CAP.	0.1uF	16V	B	GRM188B11C104KA01D	K22124805		1-	B	c3
C 7635	CHIP CAP.	0.1uF	16V	B	GRM188B11C104KA01D	K22124805		1-	A	E2
C 7636	CHIP CAP.	0.1uF	16V	B	GRM188B11C104KA01D	K22124805		1-	A	E3
C 7637	CHIP TA.CAP.	10uF	16V		TEESVA1C106M8R	K78120077		1-	B	c3
C 7638	CHIP CAP.	0.1uF	16V	B	GRM188B11C104KA01D	K22124805		1-	A	E2
C 7639	CHIP CAP.	0.1uF	16V	B	GRM188B11C104KA01D	K22124805		1-	B	c2
C 7640	CHIP TA.CAP.	10uF	16V		TEESVA1C106M8R	K78120077		1-	B	c2
C 7641	CHIP CAP.	0.1uF	16V	B	GRM188B11C104KA01D	K22124805		1-	B	c2
C 7642	CHIP CAP.	0.1uF	16V	B	GRM188B11C104KA01D	K22124805		1-	B	b3
C 7643	CHIP CAP.	0.1uF	16V	B	GRM188B11C104KA01D	K22124805		1-	B	b2
C 7644	CHIP CAP.	0.1uF	16V	B	GRM188B11C104KA01D	K22124805		1-	B	c3
C 7645	CHIP CAP.	0.1uF	16V	B	GRM188B11C104KA01D	K22124805		1-	B	c3

DSP Unit

Parts List

REF	DESCRIPTION	VALUE	V/W	TOL.	MFR'S DESIG	VXSTD P/N	VERS.	LOT	SIDE	LAY ADR
C 7646	CHIP CAP.	0.1uF	16V	B	GRM188B11C104KA01D	K22124805		1-	B	b2
C 7647	CHIP CAP.	0.1uF	16V	B	GRM188B11C104KA01D	K22124805		1-	B	b2
C 7648	CHIP CAP.	0.1uF	16V	B	GRM188B11C104KA01D	K22124805		1-	A	E2
C 7649	CHIP TA.CAP.	10uF	16V		TEESVA1C106M8R	K78120077		1-	B	c2
C 7650	CHIP TA.CAP.	10uF	16V		TEESVA1C106M8R	K78120077		1-	B	c2
C 7651	CHIP CAP.	0.1uF	16V	B	GRM188B11C104KA01D	K22124805		1-	A	D2
C 7652	CHIP CAP.	0.1uF	16V	B	GRM188B11C104KA01D	K22124805		1-	A	B2
D 7501	LED				SML-310VTT86JK	G2071032		1-	A	C3
D 7502	LED				SML-310VTT86JK	G2071032		1-	A	C3
FB7501	CHIP COI				BLM18BD182SN1D	L1690602		1-	A	C1
FB7502	CHIP COI				BLM18BD182SN1D	L1690602		1-	A	C1
FB7503	CHIP COI				BLM18BD182SN1D	L1690602		1-	A	C1
FB7504	CHIP COI				BLM18BD182SN1D	L1690602		1-	A	C1
FB7505	FERRITE BEADS				BK2125HS101-T	L9190087		1-	A	B1
J 7501	CONNECTOR				SB20-08WS	P0090615		1-	A	A2
J 7502	CONNECTOR				SB20-12WS	P0090619		1-	A	C1
J 7503	CONNECTOR				IMSA-9202B-1-02-T	P0091174		1-	A	E1
J 7504	CONNECTOR				A1-14PA-2.54DSA(71)	P0091448		1-	A	C2
J 7505	CONNECTOR				A1-10PA-2.54DSA(71)	P0091447		1-	A	E1
J 7506	CONNECTOR				A1-34PA-2.54DSA(71)	P0091449		1-	A	E3
L 7501	M.RFC	470uH			CDRH105RNP-471NC-VS	L1691359		1-	A	A1
L 7502	M.RFC	470uH			CDRH105RNP-471NC-VS	L1691359		1-	A	B1
L 7503	CHIP COIL	6.2uH			CDRH5D28NP-6R2	L1691444		1-	A	C2
L 7504	CHIP COIL	6.2uH			CDRH5D28NP-6R2	L1691444		1-	A	B2
Q 7501	IC				NJM78L05UA-TE1	G1091325		1-	A	B1
Q 7502	IC				SN74LVC244APWR	G1094336		1-	A	C1
Q 7503	IC				CS4272-CZZ	G1094319		1-	A	B2
Q 7504	IC				AD5541JR	G1094335		1-	A	B2
Q 7505	IC				EPM3064ATC100-7N	G1094320		1-	A	D1
Q 7506	IC				ST16C550CQ48-F	G1094323		1-	A	D1
Q 7507	IC				TPS62040DGQ	G1094328		1-	A	C1
Q 7508	IC				TPS62046DGQ	G1094329		1-	A	B1
Q 7509	IC				NJM2068V-TE1	G1094112		1-	A	A1
Q 7510	IC				NJM2068V-TE1	G1094112		1-	A	A2
Q 7511	IC				NJM2068V-TE1	G1094112		1-	A	A2
Q 7512	IC				NJM2068V-TE1	G1094112		1-	A	A2
Q 7513	IC				NJM2068V-TE1	G1094112		1-	A	A3
Q 7514	IC				NJM2068V-TE1	G1094112		1-	A	B2
Q 7515	IC				SN74LVC245APWR	G1094337		1-	A	C1
Q 7516	IC				TPS3808G50	G1094327		1-	A	C1
Q 7517	IC				TPS3808G33	G1094326		1-	A	B2
Q 7518	IC				TPS3808G01	G1094325		1-	A	C1
Q 7519	IC				TMS320C6713BZDP-225	G1094324		1-	A	C2
Q 7520	IC				IS42S16800B-7TL	G1094321		1-	A	E3
Q 7521	IC				M29LV400TC-90PFTN	G1094318		1-	A	E2
R 7501	CHIP RES.	0	1/16W	5%	RMC1/16 000JATP	J24185000		1-	A	C1
R 7502	CHIP RES.	0	1/16W	5%	RMC1/16 000JATP	J24185000		1-	A	B3
R 7503	CHIP RES.	47k	1/16W	1%	RMC1/16 473FTP	J24183473		1-	A	A1
R 7504	CHIP RES.	1k	1/16W	1%	RMC1/16 102FTP	J24183102		1-	A	A1
R 7505	CHIP RES.	1k	1/16W	1%	RMC1/16 102FTP	J24183102		1-	A	A2
R 7506	CHIP RES.	1k	1/16W	1%	RMC1/16 102FTP	J24183102		1-	A	A2
R 7507	CHIP RES.	47k	1/16W	1%	RMC1/16 473FTP	J24183473		1-	A	A2
R 7508	CHIP RES.	47k	1/16W	1%	RMC1/16 473FTP	J24183473		1-	A	A3
R 7509	CHIP RES.	100	1/16W	1%	RMC1/16 101FTP	J24183101		1-	A	A2
R 7510	CHIP RES.	1k	1/16W	1%	RMC1/16 102FTP	J24183102		1-	A	A3
R 7511	CHIP RES.	0	1/16W	5%	RMC1/16 000JATP	J24185000		1-	A	B3
R 7512	CHIP RES.	0	1/16W	5%	RMC1/16 000JATP	J24185000		1-	A	B3
R 7513	CHIP RES.	1.5k	1/16W	1%	RMC1/16 152FTP	J24183152		1-	A	B1
R 7514	CHIP RES.	15k	1/16W	1%	RMC1/16 153FTP	J24183153		1-	A	A2
R 7515	CHIP RES.	15k	1/16W	1%	RMC1/16 153FTP	J24183153		1-	A	A2
R 7516	CHIP RES.	0	1/16W	5%	RMC1/16 000JATP	J24185000		1-	A	B3
R 7517	CHIP RES.	0	1/16W	5%	RMC1/16 000JATP	J24185000		1-	A	B1
R 7518	CHIP RES.	7.5k	1/16W	1%	RMC1/16 752FTP	J24183752		1-	A	B1
R 7519	CHIP RES.	4.7k	1/16W	1%	RMC1/16 472FTP	J24183472		1-	A	A2
R 7520	CHIP RES.	4.7k	1/16W	1%	RMC1/16 472FTP	J24183472		1-	A	A2
R 7521	CHIP RES.	10k	1/16W	1%	RMC1/16 103FTP	J24183103		1-	A	A2
R 7522	CHIP RES.	10k	1/16W	1%	RMC1/16 103FTP	J24183103		1-	A	A2
R 7523	CHIP RES.	0	1/16W	5%	RMC1/16 000JATP	J24185000		1-	A	B1
R 7524	CHIP RES.	0	1/16W	5%	RMC1/16 000JATP	J24185000		1-	A	A3
R 7525	CHIP RES.	4.7k	1/16W	1%	RMC1/16 472FTP	J24183472		1-	A	A3
R 7526	CHIP RES.	4.7k	1/16W	1%	RMC1/16 472FTP	J24183472		1-	A	A3
R 7527	CHIP RES.	5.6k	1/16W	1%	RMC1/16 562FTP	J24183562		1-	A	A1
R 7528	CHIP RES.	5.6k	1/16W	1%	RMC1/16 562FTP	J24183562		1-	A	A2

DSP Unit

Parts List

REF	DESCRIPTION	VALUE	V/W	TOL.	MFR'S DESIG	VXSTD P/N	VERS.	LOT	SIDE	LAY ADR
R 7529	CHIP RES.	4.7k	1/16W	1%	RMC1/16 472FTP	J24183472		1-	A	A2
R 7530	CHIP RES.	4.7k	1/16W	1%	RMC1/16 472FTP	J24183472		1-	A	A2
R 7531	CHIP RES.	4.7k	1/16W	1%	RMC1/16 472FTP	J24183472		1-	A	A3
R 7532	CHIP RES.	4.7k	1/16W	1%	RMC1/16 472FTP	J24183472		1-	A	A3
R 7533	CHIP RES.	4.7k	1/16W	1%	RMC1/16 472FTP	J24183472		1-	A	A2
R 7534	CHIP RES.	4.7k	1/16W	1%	RMC1/16 472FTP	J24183472		1-	A	A2
R 7535	CHIP RES.	4.7k	1/16W	1%	RMC1/16 472FTP	J24183472		1-	A	A1
R 7536	CHIP RES.	4.7k	1/16W	1%	RMC1/16 472FTP	J24183472		1-	A	A2
R 7537	CHIP RES.	4.7k	1/16W	1%	RMC1/16 472FTP	J24183472		1-	A	A3
R 7538	CHIP RES.	4.7k	1/16W	1%	RMC1/16 472FTP	J24183472		1-	A	A3
R 7539	CHIP RES.	1k	1/16W	1%	RMC1/16 102FTP	J24183102		1-	A	A2
R 7540	CHIP RES.	2.2k	1/16W	1%	RMC1/16 222FTP	J24183222		1-	A	A1
R 7541	CHIP RES.	2.2k	1/16W	1%	RMC1/16 222FTP	J24183222		1-	A	A2
R 7542	CHIP RES.	1k	1/16W	1%	RMC1/16 102FTP	J24183102		1-	A	A2
R 7543	CHIP RES.	1k	1/16W	1%	RMC1/16 102FTP	J24183102		1-	A	A3
R 7544	CHIP RES.	1k	1/16W	1%	RMC1/16 102FTP	J24183102		1-	A	A2
R 7545	CHIP RES.	1k	1/16W	1%	RMC1/16 102FTP	J24183102		1-	A	A2
R 7546	CHIP RES.	4.7k	1/16W	1%	RMC1/16 472FTP	J24183472		1-	A	A1
R 7547	CHIP RES.	4.7k	1/16W	1%	RMC1/16 472FTP	J24183472		1-	A	A2
R 7548	CHIP RES.	470	1/16W	1%	RMC1/16 471FTP	J24183471		1-	A	A2
R 7549	CHIP RES.	470	1/16W	1%	RMC1/16 471FTP	J24183471		1-	A	A2
R 7550	CHIP RES.	470	1/16W	1%	RMC1/16 471FTP	J24183471		1-	A	A3
R 7551	CHIP RES.	470	1/16W	1%	RMC1/16 471FTP	J24183471		1-	A	A3
R 7552	CHIP RES.	1k	1/16W	1%	RMC1/16 102FTP	J24183102		1-	A	A1
R 7553	CHIP RES.	1k	1/16W	1%	RMC1/16 102FTP	J24183102		1-	A	A1
R 7554	CHIP RES.	1k	1/16W	1%	RMC1/16 102FTP	J24183102		1-	A	A2
R 7555	CHIP RES.	1k	1/16W	1%	RMC1/16 102FTP	J24183102		1-	A	A2
R 7556	CHIP RES.	1.5k	1/16W	1%	RMC1/16 152FTP	J24183152		1-	A	A2
R 7557	CHIP RES.	1.5k	1/16W	1%	RMC1/16 152FTP	J24183152		1-	A	A2
R 7558	CHIP RES.	1.5k	1/16W	1%	RMC1/16 152FTP	J24183152		1-	A	A3
R 7559	CHIP RES.	1.5k	1/16W	1%	RMC1/16 152FTP	J24183152		1-	A	A2
R 7560	CHIP RES.	10	1/16W	5%	RMC1/16 100JATP	J24185100		1-	A	B2
R 7563	CHIP RES.	4.7k	1/16W	5%	RMC1/16 472JATP	J24185472		1-	A	D1
R 7564	CHIP RES.	4.7k	1/16W	5%	RMC1/16 472JATP	J24185472		1-	A	D1
R 7565	CHIP RES.	1k	1/16W	5%	RMC1/16 102JATP	J24185102		1-	A	C1
R 7566	CHIP RES.	4.7k	1/16W	5%	RMC1/16 472JATP	J24185472		1-	A	B2
R 7568	CHIP RES.	1k	1/16W	5%	RMC1/16 102JATP	J24185102		1-	A	C1
R 7570	CHIP RES.	4.7k	1/16W	5%	RMC1/16 472JATP	J24185472		1-	A	D1
R 7571	CHIP RES.	4.7k	1/16W	5%	RMC1/16 472JATP	J24185472		1-	A	D1
R 7572	CHIP RES.	4.7k	1/16W	5%	RMC1/16 472JATP	J24185472		1-	A	D1
R 7573	CHIP RES.	33	1/16W	5%	RMC1/16 330JATP	J24185330		1-	A	D1
R 7574	CHIP RES.	33	1/16W	5%	RMC1/16 330JATP	J24185330		1-	A	D1
R 7576	CHIP RES.	4.7k	1/16W	5%	RMC1/16 472JATP	J24185472		1-	A	B2
R 7578	CHIP RES.	4.7k	1/16W	5%	RMC1/16 472JATP	J24185472		1-	A	B2
R 7579	CHIP RES.	4.7k	1/16W	5%	RMC1/16 472JATP	J24185472		1-	A	B2
R 7580	CHIP RES.	33	1/16W	5%	RMC1/16 330JATP	J24185330		1-	A	D1
R 7581	CHIP RES.	4.7k	1/16W	5%	RMC1/16 472JATP	J24185472		1-	A	D1
R 7583	CHIP RES.	10k	1/16W	5%	RMC1/16 103JATP	J24185103		1-	A	C1
R 7584	CHIP RES.	10k	1/16W	5%	RMC1/16 103JATP	J24185103		1-	A	C1
R 7585	CHIP RES.	47k	1/16W	1%	RMC1/16 473FTP	J24183473		1-	A	C1
R 7586	CHIP RES.	470k	1/16W	5%	RMC1/16 474JATP	J24185474		1-	A	C2
R 7587	CHIP RES.	270k	1/16W	5%	RMC1/16 274JATP	J24185274		1-	A	C2
R 7588	CHIP RES.	39k	1/16W	5%	RMC1/16 393JATP	J24185393		1-	A	C2
R 7589	CHIP RES.	10k	1/16W	5%	RMC1/16 103JATP	J24185103		1-	A	B2
R 7591	CHIP RES.	180k	1/16W	5%	RMC1/16 184JATP	J24185184		1-	A	C2
R 7592	CHIP RES.	2.2k	1/16W	5%	RMC1/16 222JATP	J24185222		1-	A	C1
R 7593	CHIP RES.	100k	1/16W	5%	RMC1/16 104JATP	J24185104		1-	A	C1
R 7596	CHIP RES.	4.7k	1/16W	5%	RMC1/16 472JATP	J24185472		1-	A	B2
R 7597	CHIP RES.	1k	1/16W	5%	RMC1/16 102JATP	J24185102		1-	A	E1
R 7598	CHIP RES.	1k	1/16W	5%	RMC1/16 102JATP	J24185102		1-	A	E1
R 7599	CHIP RES.	1k	1/16W	5%	RMC1/16 102JATP	J24185102		1-	A	E1
R 7602	CHIP RES.	4.7k	1/16W	5%	RMC1/16 472JATP	J24185472		1-	A	B2
R 7604	CHIP RES.	4.7k	1/16W	5%	RMC1/16 472JATP	J24185472		1-	B	a2
R 7605	CHIP RES.	4.7k	1/16W	5%	RMC1/16 472JATP	J24185472		1-	A	C2
R 7606	CHIP RES.	4.7k	1/16W	5%	RMC1/16 472JATP	J24185472		1-	A	E2
R 7607	CHIP RES.	4.7k	1/16W	5%	RMC1/16 472JATP	J24185472		1-	A	E2
R 7608	CHIP RES.	4.7k	1/16W	5%	RMC1/16 472JATP	J24185472		1-	A	E2
R 7609	CHIP RES.	4.7k	1/16W	5%	RMC1/16 472JATP	J24185472		1-	A	E2
R 7610	CHIP RES.	4.7k	1/16W	5%	RMC1/16 472JATP	J24185472		1-	A	E2
R 7611	CHIP RES.	4.7k	1/16W	5%	RMC1/16 472JATP	J24185472		1-	A	E1
R 7612	CHIP RES.	4.7k	1/16W	5%	RMC1/16 472JATP	J24185472		1-	A	E2
R 7614	CHIP RES.	4.7k	1/16W	5%	RMC1/16 472JATP	J24185472		1-	A	E2
R 7616	CHIP RES.	4.7k	1/16W	5%	RMC1/16 472JATP	J24185472		1-	A	E3

DSP Unit

Parts List

REF	DESCRIPTION	VALUE	V/W	TOL.	MFR'S DESIG	VXSTD P/N	VERS.	LOT	SIDE	LAY ADR
R 7618	CHIP RES.	4.7k	1/16W	5%	RMC1/16 472JATP	J24185472		1-	A	E2
R 7619	CHIP RES.	4.7k	1/16W	5%	RMC1/16 472JATP	J24185472		1-	A	E2
R 7620	CHIP RES.	4.7k	1/16W	5%	RMC1/16 472JATP	J24185472		1-	A	E2
R 7621	CHIP RES.	4.7k	1/16W	5%	RMC1/16 472JATP	J24185472		1-	A	E2
R 7622	CHIP RES.	4.7k	1/16W	5%	RMC1/16 472JATP	J24185472		1-	A	E1
R 7623	CHIP RES.	4.7k	1/16W	5%	RMC1/16 472JATP	J24185472		1-	A	D3
R 7624	CHIP RES.	4.7k	1/16W	5%	RMC1/16 472JATP	J24185472		1-	A	D3
R 7625	CHIP RES.	1k	1/16W	5%	RMC1/16 102JATP	J24185102		1-	A	C3
R 7626	CHIP RES.	3.3k	1/16W	5%	RMC1/16 332JATP	J24185332		1-	A	C3
R 7627	CHIP RES.	3.3k	1/16W	5%	RMC1/16 332JATP	J24185332		1-	A	C3
R 7628	CHIP RES.	4.7k	1/16W	5%	RMC1/16 472JATP	J24185472		1-	A	C2
R 7630	CHIP RES.	0	1/16W	5%	RMC1/16 000JATP	J24185000		1-	A	D2
R 7631	CHIP RES.	4.7k	1/16W	5%	RMC1/16 472JATP	J24185472		1-	A	D3
R 7632	CHIP RES.	4.7k	1/16W	5%	RMC1/16 472JATP	J24185472		1-	A	D2
R 7633	CHIP RES.	4.7k	1/16W	5%	RMC1/16 472JATP	J24185472		1-	A	D1
R 7634	CHIP RES.	0	1/16W	5%	RMC1/16 000JATP	J24185000		1-	A	D2
R 7636	CHIP RES.	33	1/16W	5%	RMC1/16 330JATP	J24185330		1-	A	C3
R 7637	CHIP RES.	33	1/16W	5%	RMC1/16 330JATP	J24185330		1-	A	D1
S 7501	TACT SWITCH				SKQYPAE010	N5090144		1-	A	C1
X 7501	XTAL OSC	25MHz			TPS18XC 25.000MHZ	H9501020		1-	A	C3
X 7502	XTAL OSC	18.432MHz			TPS18XC 18.432MHZ	H9501010		1-	A	D1
	SEMS SCREW BIND HEAD TAPTITE-B				ASM3X6NI M2.6X6NI	U03306002 U24206002		1- 1-		

DSP Unit

Note:

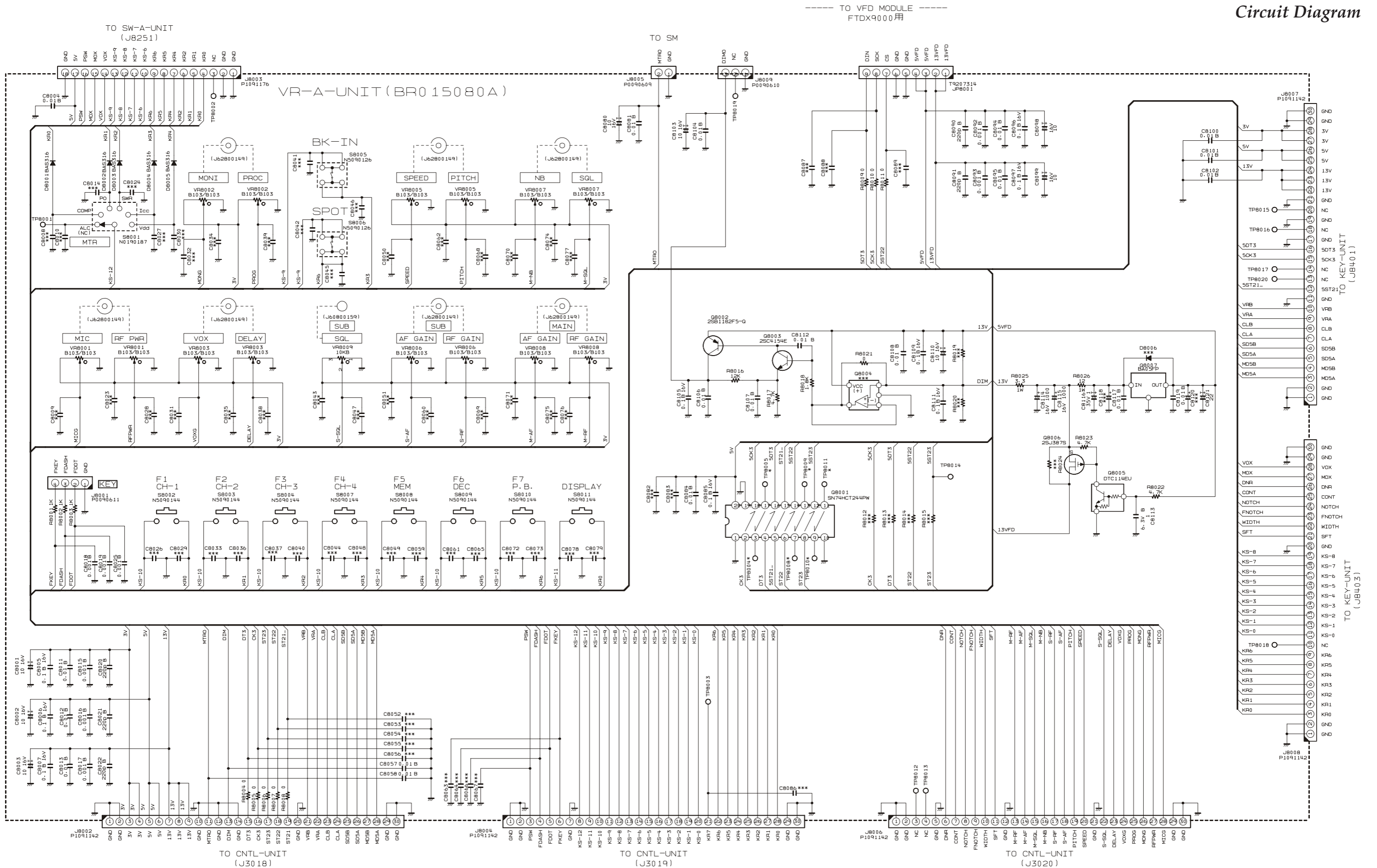

VR-A Unit

Note

VR-A Unit
Parts Layout (Side A)

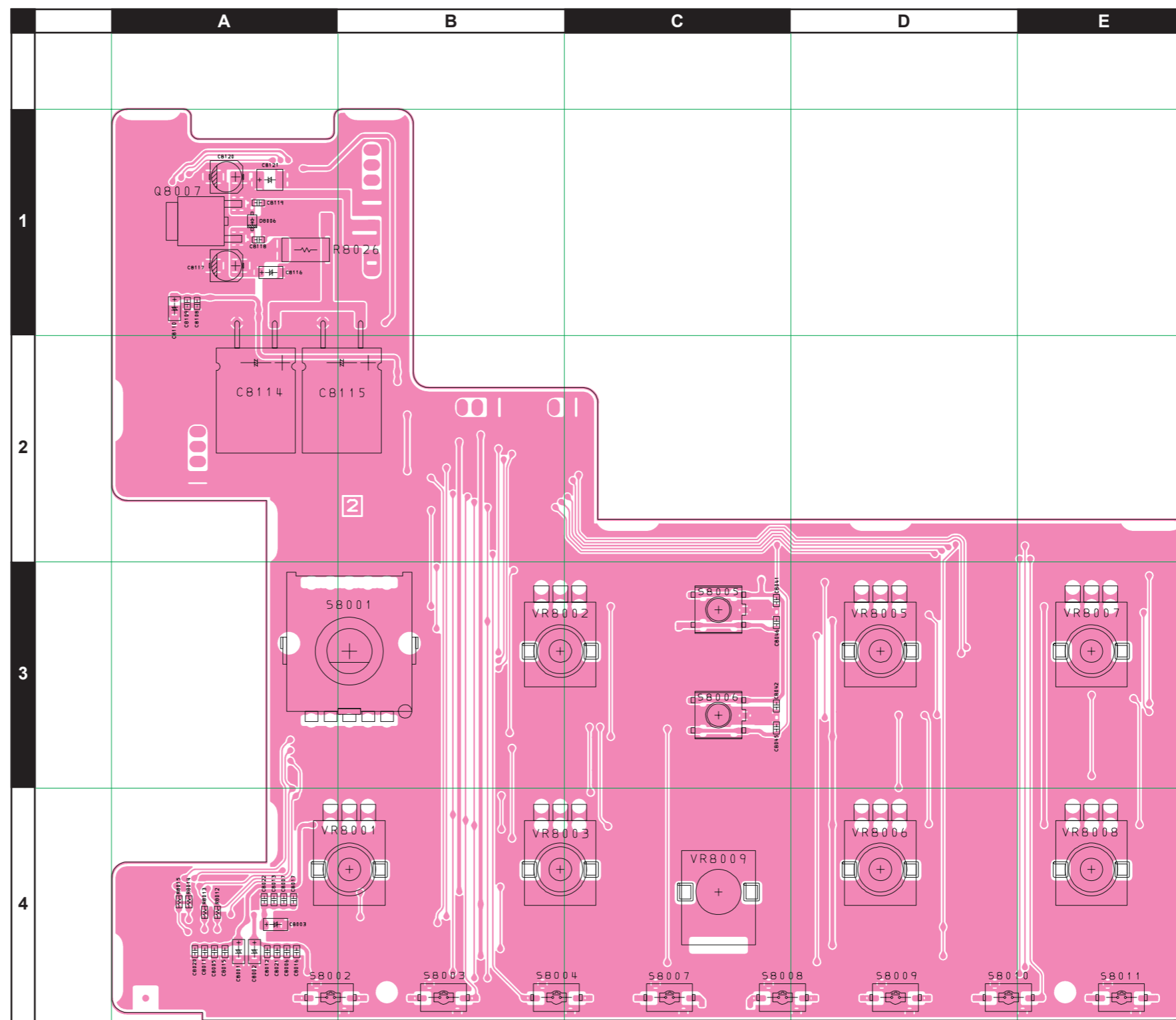
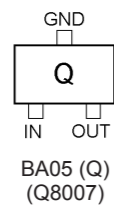

VR-A Unit

Parts Layout (Side B)

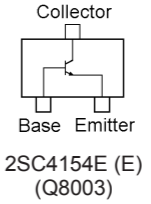
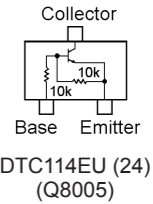
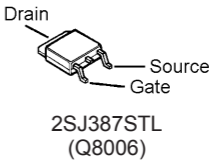
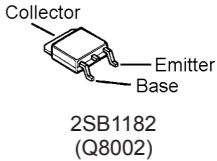
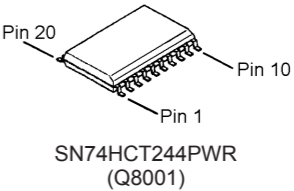
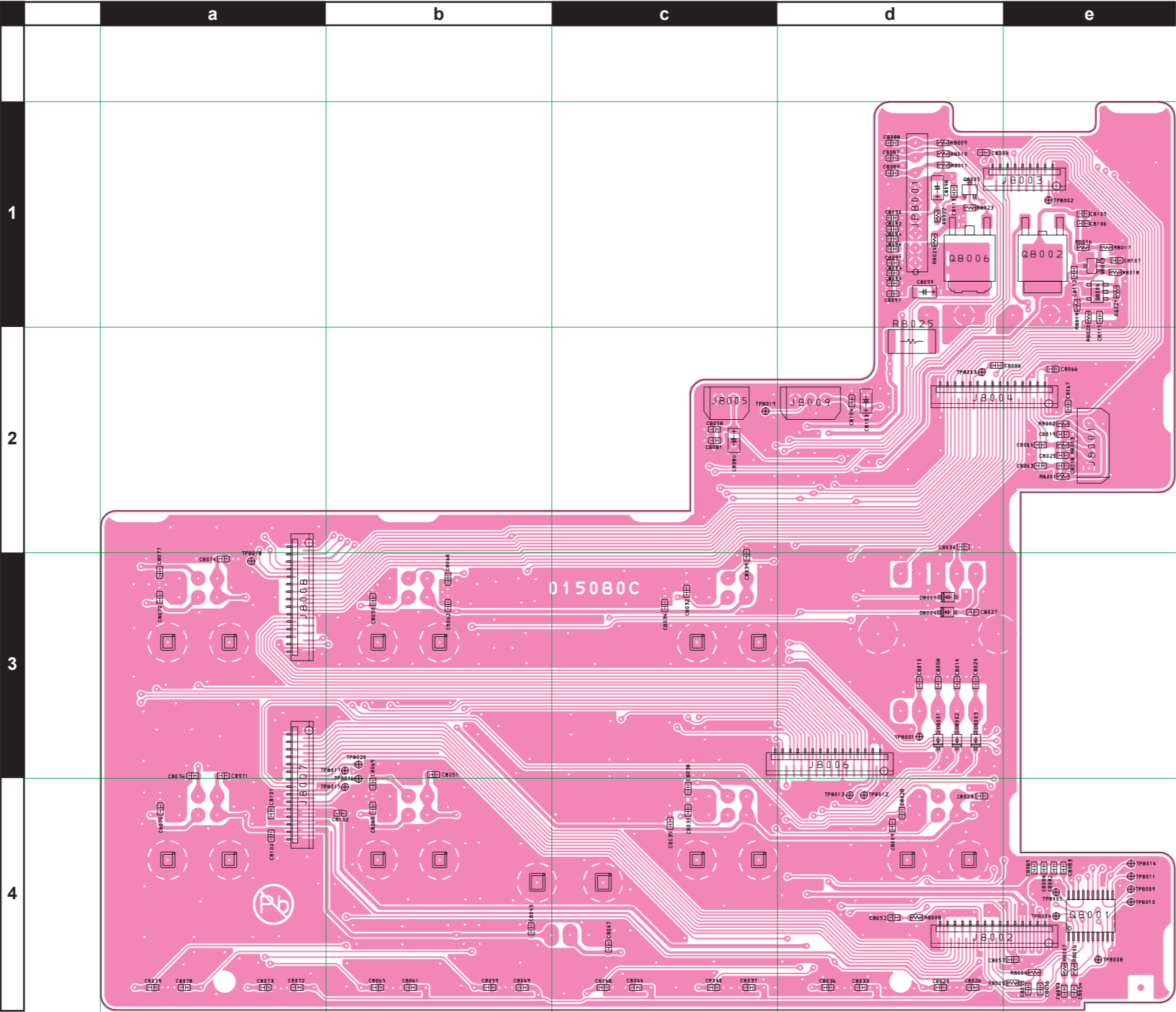

VR-A Unit

Parts List

REF	DESCRIPTION	VALUE	V/W	TOL.	MFR'S DESIG	VXSTD P/N	VERS.	LOT	SIDE	LAY ADR
PCB with Components						CB3629001				
	Printed Circuit Board				AH025H000	FR0150800			1-	
C 8001	CHIP TA.CAP.	10uF	16V		TEESVA1C106M8R	K78120077			1-	A A4
C 8002	CHIP TA.CAP.	10uF	16V		TEESVA1C106M8R	K78120077			1-	A A4
C 8003	CHIP TA.CAP.	10uF	16V		TEESVA1C106M8R	K78120077			1-	A A4
C 8004	CHIP CAP.	0.01uF	50V	B	GRM188B11H103KA01D	K22174823			1-	B d1
C 8005	CHIP CAP.	0.1uF	16V	B	GRM188B11C104KA01D	K22124805			1-	A A4
C 8006	CHIP CAP.	0.1uF	16V	B	GRM188B11C104KA01D	K22124805			1-	A A4
C 8007	CHIP CAP.	0.1uF	16V	B	GRM188B11C104KA01D	K22124805			1-	A A4
C 8011	CHIP CAP.	0.01uF	50V	B	GRM188B11H103KA01D	K22174823			1-	A A4
C 8012	CHIP CAP.	0.01uF	50V	B	GRM188B11H103KA01D	K22174823			1-	A A4
C 8013	CHIP CAP.	0.01uF	50V	B	GRM188B11H103KA01D	K22174823			1-	A A4
C 8015	CHIP CAP.	0.001uF	50V	B	GRM188B11H102KA01D	K22174809			1-	A A4
C 8016	CHIP CAP.	0.001uF	50V	B	GRM188B11H102KA01D	K22174809			1-	A A4
C 8017	CHIP CAP.	0.001uF	50V	B	GRM188B11H102KA01D	K22174809			1-	A A4
C 8018	CHIP CAP.	0.001uF	50V	B	GRM188B11H102KA01D	K22174809			1-	B e2
C 8019	CHIP CAP.	0.001uF	50V	B	GRM188B11H102KA01D	K22174809			1-	B e2
C 8020	CHIP CAP.	220pF	50V	B	GRM188B11H221KA01D	K22174801			1-	A A4
C 8021	CHIP CAP.	220pF	50V	B	GRM188B11H221KA01D	K22174801			1-	A A4
C 8022	CHIP CAP.	220pF	50V	B	GRM188B11H221KA01D	K22174801			1-	A A4
C 8025	CHIP CAP.	0.001uF	50V	B	GRM188B11H102KA01D	K22174809			1-	B e2
C 8057	CHIP CAP.	0.01uF	50V	B	GRM188B11H103KA01D	K22174823			1-	B e4
C 8058	CHIP CAP.	0.01uF	50V	B	GRM188B11H103KA01D	K22174823			1-	B c2
C 8080	CHIP TA.CAP.	10uF	16V		TEESVA1C106M8R	K78120077			1-	B c2
C 8081	CHIP CAP.	0.01uF	50V	B	GRM188B11H103KA01D	K22174823			1-	B c2
C 8084	CHIP CAP.	0.01uF	50V	B	GRM188B11H103KA01D	K22174823			1-	B e4
C 8085	CHIP CAP.	0.1uF	16V	B	GRM188B11C104KA01D	K22124805			1-	B e4
C 8090	CHIP CAP.	220pF	50V	B	GRM188B11H221KA01D	K22174801			1-	B d1
C 8091	CHIP CAP.	220pF	50V	B	GRM188B11H221KA01D	K22174801			1-	B d1
C 8092	CHIP CAP.	0.001uF	50V	B	GRM188B11H102KA01D	K22174809			1-	B d1
C 8093	CHIP CAP.	0.001uF	50V	B	GRM188B11H102KA01D	K22174809			1-	B d1
C 8094	CHIP CAP.	0.01uF	50V	B	GRM188B11H103KA01D	K22174823			1-	B d1
C 8095	CHIP CAP.	0.01uF	50V	B	GRM188B11H103KA01D	K22174823			1-	B d1
C 8096	CHIP CAP.	0.1uF	16V	B	GRM188B11C104KA01D	K22124805			1-	B d1
C 8097	CHIP CAP.	0.1uF	16V	B	GRM188B11C104KA01D	K22124805			1-	B d1
C 8098	CHIP TA.CAP.	10uF	16V		TEESVA1C106M8R	K78120077			1-	B d1
C 8099	CHIP TA.CAP.	10uF	16V		TEESVA1C106M8R	K78120077			1-	B d1
C 8100	CHIP CAP.	0.01uF	50V	B	GRM188B11H103KA01D	K22174823			1-	B a4
C 8101	CHIP CAP.	0.01uF	50V	B	GRM188B11H103KA01D	K22174823			1-	B a4
C 8102	CHIP CAP.	0.01uF	50V	B	GRM188B11H103KA01D	K22174823			1-	B b4
C 8103	CHIP TA.CAP.	10uF	16V		TEESVA1C106M8R	K78120077			1-	B d2
C 8104	CHIP CAP.	0.01uF	50V	B	GRM188B11H103KA01D	K22174823			1-	B d2
C 8105	CHIP CAP.	0.1uF	16V	B	GRM188B11C104KA01D	K22124805			1-	B e1
C 8106	CHIP CAP.	0.01uF	50V	B	GRM188B11H103KA01D	K22174823			1-	B e1
C 8107	CHIP CAP.	0.01uF	50V	B	GRM188B11H103KA01D	K22174823			1-	B e1
C 8108	CHIP CAP.	0.01uF	50V	B	GRM188B11H103KA01D	K22174823			1-	A A1
C 8109	CHIP CAP.	0.1uF	16V	B	GRM188B11C104KA01D	K22124805			1-	A A1
C 8110	CHIP TA.CAP.	10uF	16V		TEESVA1C106M8R	K78120077			1-	A A1
C 8111	CHIP CAP.	0.1uF	16V	B	GRM188B11C104KA01D	K22124805			1-	B e1
C 8112	CHIP CAP.	0.01uF	50V	B	GRM188B11H103KA01D	K22174823			1-	B e1
C 8113	CHIP CAP.	1uF	6.3V	B	GRM188B10J105KA01D	K22084801			1-	B d1
C 8114	AL.ELECTRO.CAP.	1000uF	16V		RE3-16V102MH3#	K40129096			1-	A A1
C 8115	AL.ELECTRO.CAP.	1000uF	16V		RE3-16V102MH3#	K40129096			1-	A B1
C 8116	CHIP TA.CAP.	1uF	35V		TEMSVA1V105M-8R	K78160032			1-	A A1
C 8118	CHIP CAP.	0.01uF	50V	B	GRM188B11H103KA01D	K22174823			1-	A A1
C 8119	CHIP CAP.	0.01uF	50V	B	GRM188B11H103KA01D	K22174823			1-	A A1
C 8121	CHIP TA.CAP.	22uF			TPSB226M016Y0600	K78120075			1-	A A1
D 8001	DIODE				BAS316	G2070716			1-	B d3
D 8002	DIODE				BAS316	G2070716			1-	B d3
D 8003	DIODE				BAS316	G2070716			1-	B d3
D 8004	DIODE				BAS316	G2070716			1-	B d3
D 8005	DIODE				BAS316	G2070716			1-	B d3
J 8001	CONNECTOR				SB20-04WS	P0090611			1-	B e2
J 8002	CONNECTOR				30FLT-SM1-TB	P1091142			1-	B d4
J 8003	CONNECTOR				18FLT-SM1-TB	P1091176			1-	B e1
J 8004	CONNECTOR				30FLT-SM1-TB	P1091142			1-	B d2
J 8005	CONNECTOR				SB20-02WS	P0090609			1-	B c2
J 8006	CONNECTOR				30FLT-SM1-TB	P1091142			1-	B d3
J 8007	CONNECTOR				30FLT-SM1-TB	P1091142			1-	B a4
J 8008	CONNECTOR				30FLT-SM1-TB	P1091142			1-	B a3
J 8009	CONNECTOR				SB20-03WS	P0090610			1-	B d2
JP8001	WIRE ASSY				AH025H 300MM	T9207314			1-	B d1
JP8001	WIRE ASSY				AH025H 180MM	T9207314A			3-	B d1

VR-A Unit

Parts List

REF	DESCRIPTION	VALUE	V/W	TOL.	MFR'S DESIG	VXSTD P/N	VERS.	LOT	SIDE	LAY ADR
Q 8001	IC				SN74HCT244PWR	G1094091		1-	B	e4
Q 8002	TRANSISTOR				2SB1182-TLQ	G3070063		1-	B	e1
Q 8003	TRANSISTOR				2SC4154-T11-1E	G3341548E		1-	B	e1
Q 8005	TRANSISTOR				DTC114EUA T106	G3070084		1-	B	d1
Q 8006	FET				2SJ387STL	G3703878		1-	B	d1
Q 8007	IC				BA05FP-E2	G1093209		1-	A	A1
R 8001	CHIP RES.	1k	1/16W	5%	RMC1/16 102JATP	J24185102		1-	B	e2
R 8002	CHIP RES.	1k	1/16W	5%	RMC1/16 102JATP	J24185102		1-	B	e2
R 8003	CHIP RES.	1k	1/16W	5%	RMC1/16 102JATP	J24185102		1-	B	e2
R 8004	CHIP RES.	0	1/16W	5%	RMC1/16 000JATP	J24185000		1-	B	e4
R 8005	CHIP RES.	0	1/16W	5%	RMC1/16 000JATP	J24185000		1-	B	e4
R 8006	CHIP RES.	0	1/16W	5%	RMC1/16 000JATP	J24185000		1-	B	e4
R 8007	CHIP RES.	0	1/16W	5%	RMC1/16 000JATP	J24185000		1-	B	e4
R 8008	CHIP RES.	0	1/16W	5%	RMC1/16 000JATP	J24185000		1-	B	d4
R 8009	CHIP RES.	0	1/16W	5%	RMC1/16 000JATP	J24185000		1-	B	d1
R 8010	CHIP RES.	0	1/16W	5%	RMC1/16 000JATP	J24185000		1-	B	d1
R 8011	CHIP RES.	0	1/16W	5%	RMC1/16 000JATP	J24185000		1-	B	d1
R 8016	CHIP RES.	12k	1/16W	5%	RMC1/16 123JATP	J24185123		1-	B	e1
R 8017	CHIP RES.	4.7k	1/16W	5%	RMC1/16 472JATP	J24185472		1-	B	e1
R 8018	CHIP RES.	1.8k	1/16W	5%	RMC1/16 182JATP	J24185182		1-	B	e1
R 8021	CHIP RES.	0	1/16W	5%	RMC1/16 000JATP	J24185000		1-	B	e1
R 8022	CHIP RES.	4.7k	1/16W	5%	RMC1/16 472JATP	J24185472		1-	B	d1
R 8023	CHIP RES.	4.7k	1/16W	5%	RMC1/16 472JATP	J24185472		1-	B	d1
R 8025	CHIP RES.	3.3	1W	5%	RMC1 3R3JTE	J24305339		1-	B	d2
R 8026	CHIP RES.	12	1W	5%	RMC1 120JTE	J24305120		1-	A	A1
S 8001	ROTARY SWITCH				SRBV160800	N0190187		1-	A	B3
S 8002	TACT SWITCH				SKQYPAE010	N5090144		1-	A	A4
S 8003	TACT SWITCH				SKQYPAE010	N5090144		1-	A	B4
S 8004	TACT SWITCH				SKQYPAE010	N5090144		1-	A	B4
S 8005	TACT SWITCH				SKHUPDE010	N5090126		1-	A	C3
S 8006	TACT SWITCH				SKHUPDE010	N5090126		1-	A	C3
S 8007	TACT SWITCH				SKQYPAE010	N5090144		1-	A	C4
S 8008	TACT SWITCH				SKQYPAE010	N5090144		1-	A	C4
S 8009	TACT SWITCH				SKQYPAE010	N5090144		1-	A	D4
S 8010	TACT SWITCH				SKQYPAE010	N5090144		1-	A	D4
S 8011	TACT SWITCH				SKQYPAE010	N5090144		1-	A	E4
VR8001	POT.				RH96D190 30F B103 RY8151	J62800149		1-	A	B4
VR8002	POT.				RH96D190 30F B103 RY8151	J62800149		1-	A	B3
VR8003	POT.				RH96D190 30F B103 RY8151	J62800149		1-	A	B4
VR8005	POT.				RH96D190 30F B103 RY8151	J62800149		1-	A	D3
VR8006	POT.				RH96D190 30F B103 RY8151	J62800149		1-	A	D4
VR8007	POT.				RH96D190 30F B103 RY8151	J62800149		1-	A	E3
VR8008	POT.				RH96D190 30F B103 RY8151	J62800149		1-	A	E4
VR8009	POT.				RK09K1130AH1 10KB	J60800291		1-	A	C4

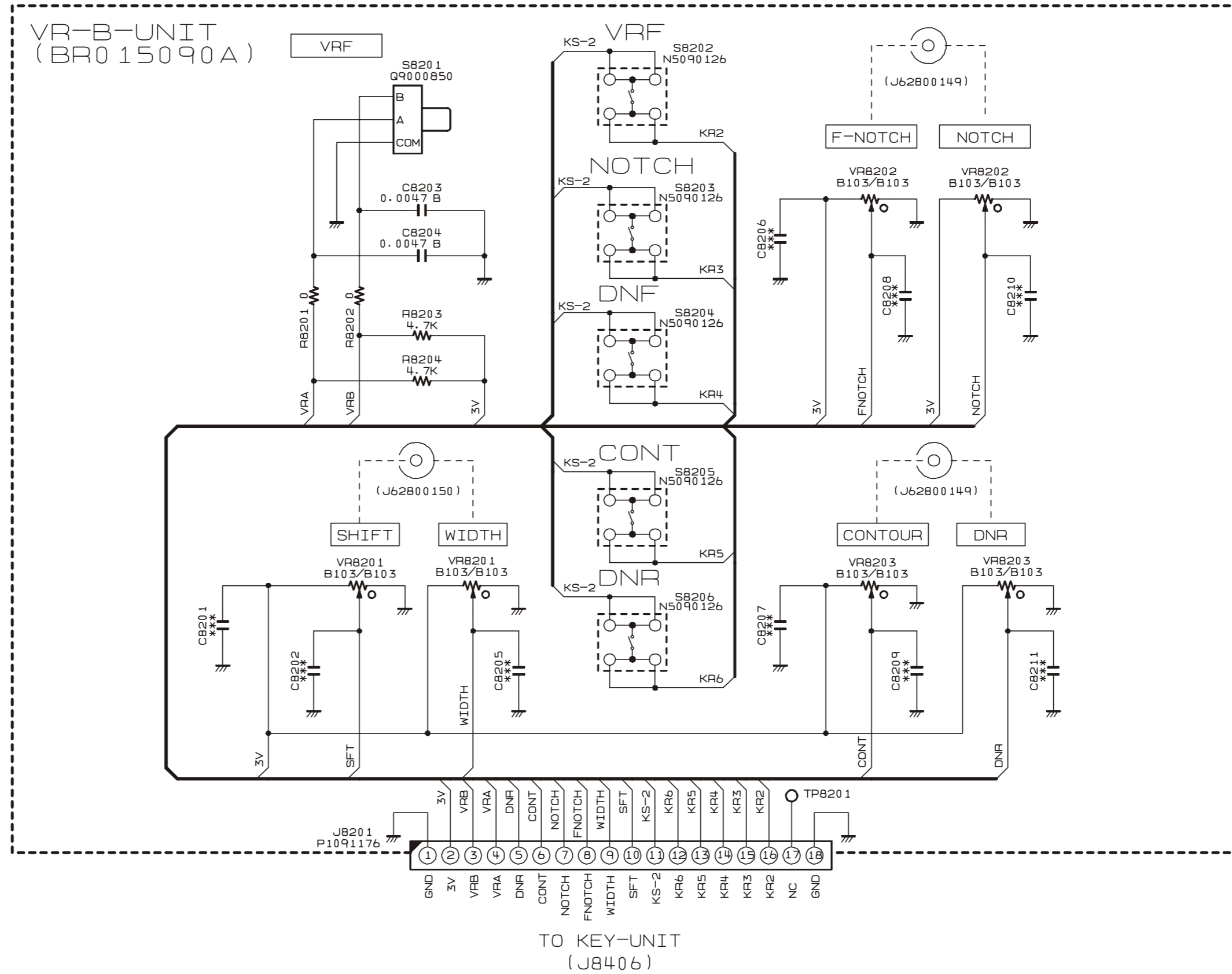

VR-B Unit

Parts Layout

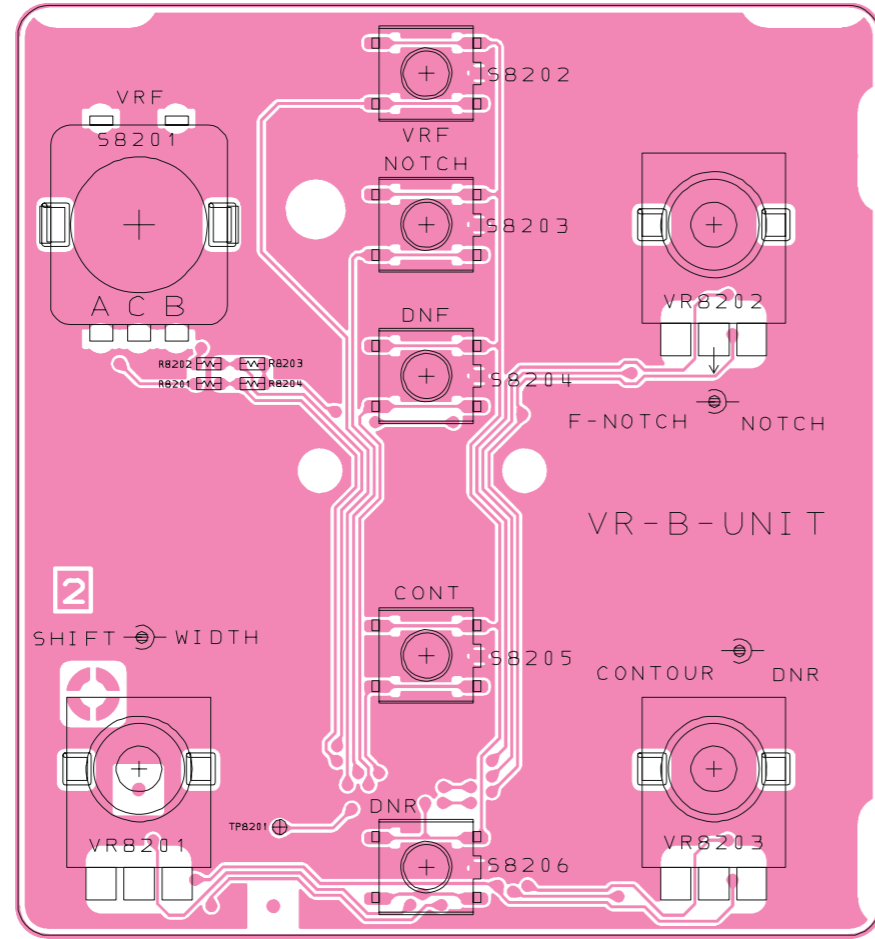

Side A

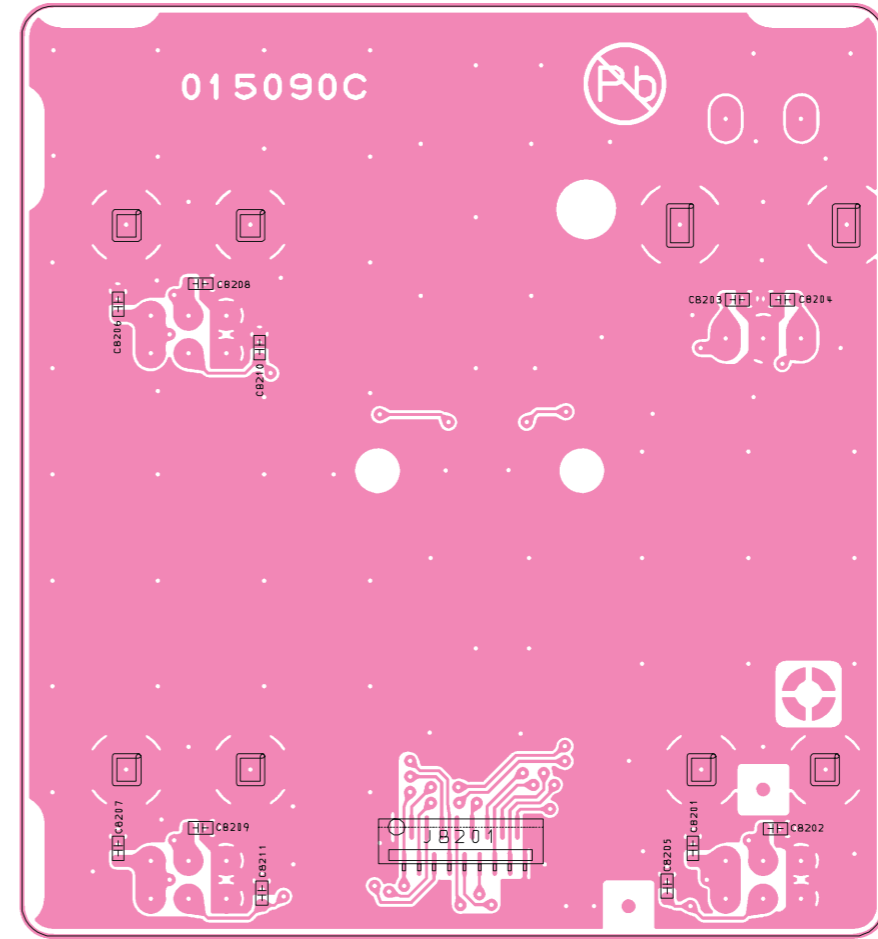

Side B

VR-B Unit

Parts List

REF	DESCRIPTION	VALUE	V/W	TOL.	MFR'S DESIG	VXSTD P/N	VERS.	LOT	SIDE	LAY ADR
PCB with Components						CB3630001				
Printed Circuit Board						AH025H000	FR0150900		1-	
C 8202	CHIP CAP.	0.01uF	25V	B	GRM39B103K25PT	K22144803		1-	B	
C 8203	CHIP CAP.	0.0047uF	50V	B	GRM188B11H472KA01D	K22174833		1-	B	
C 8204	CHIP CAP.	0.0047uF	50V	B	GRM188B11H472KA01D	K22174833		1-	B	
J 8201	CONNECTOR				18FLT-SM1-TB	P1091176		1-	B	
R 8201	CHIP RES.	0	1/16W	5%	RMC1/16 000JATP	J24185000		1-	A	
R 8202	CHIP RES.	0	1/16W	5%	RMC1/16 000JATP	J24185000		1-	A	
R 8203	CHIP RES.	4.7k	1/16W	5%	RMC1/16 472JATP	J24185472		1-	A	
R 8204	CHIP RES.	4.7k	1/16W	5%	RMC1/16 472JATP	J24185472		1-	A	
S 8201	ROTARY ENCODER				EC11G15204	Q9000850		1-	A	
S 8202	TACT SWITCH				SKHUPDE010	N5090126		1-	A	
S 8203	TACT SWITCH				SKHUPDE010	N5090126		1-	A	
S 8204	TACT SWITCH				SKHUPDE010	N5090126		1-	A	
S 8205	TACT SWITCH				SKHUPDE010	N5090126		1-	A	
S 8206	TACT SWITCH				SKHUPDE010	N5090126		1-	A	
VR8201	POT.				RH96D236 30F B103 RY8150	J62800150		1-	A	
VR8202	POT.				RH96D190 30F B103 RY8151	J62800149		1-	A	
VR8203	POT.				RH96D190 30F B103 RY8151	J62800149		1-	A	

VR-B Unit

Note:

SW-A-UNIT (BR0 15 100 A)

Provided by YAESU museum
 Downloaded by RadioAmateur.EU

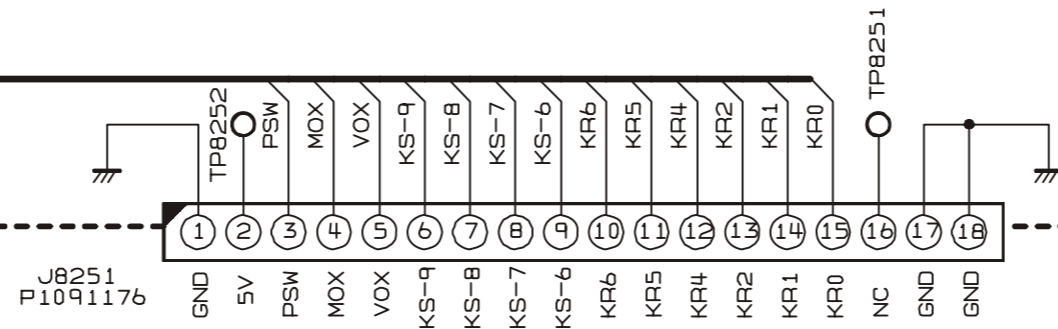
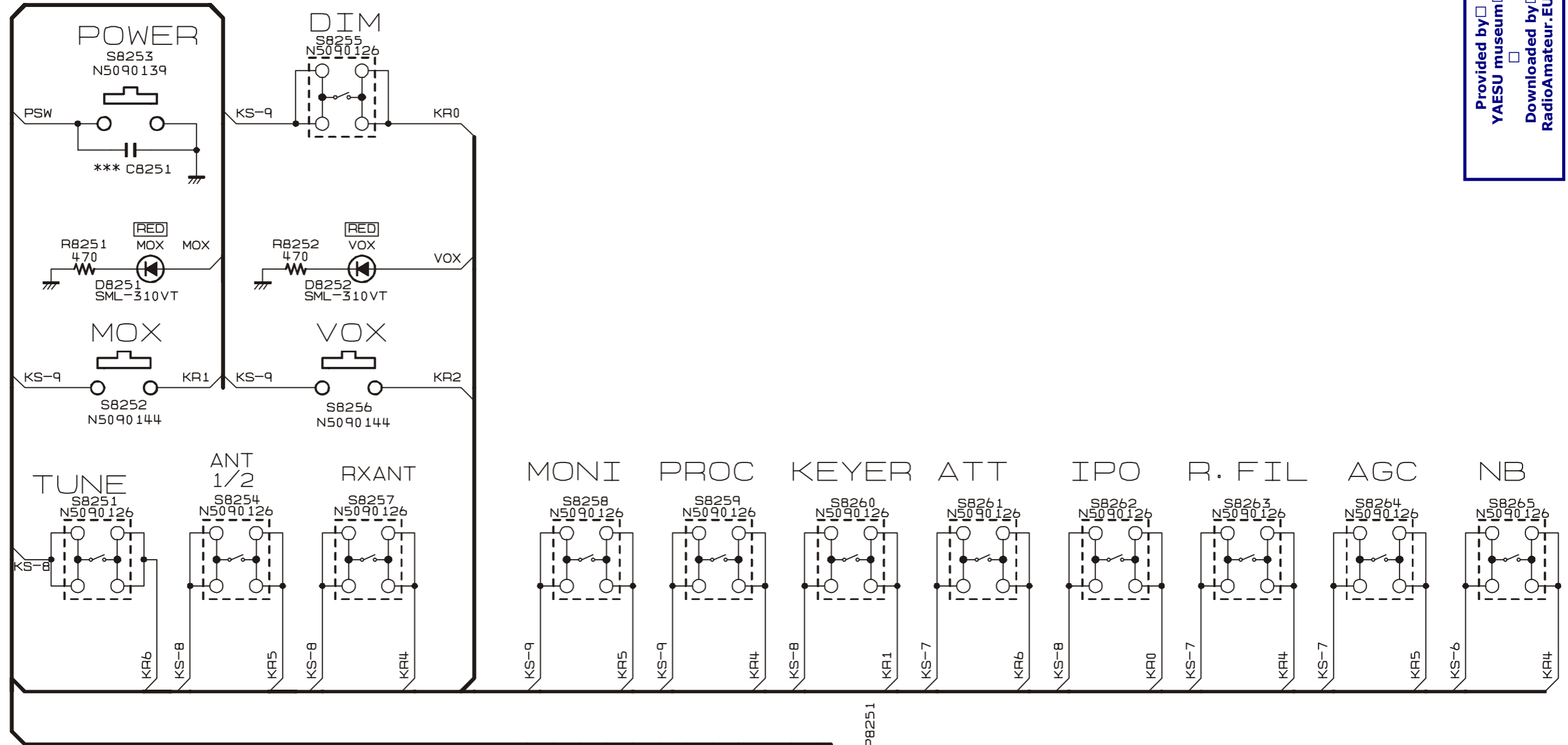

TO VR-A-UNIT
(J8003)

SW-A Unit

Note

SW-A Unit
Parts Layout (Side A)

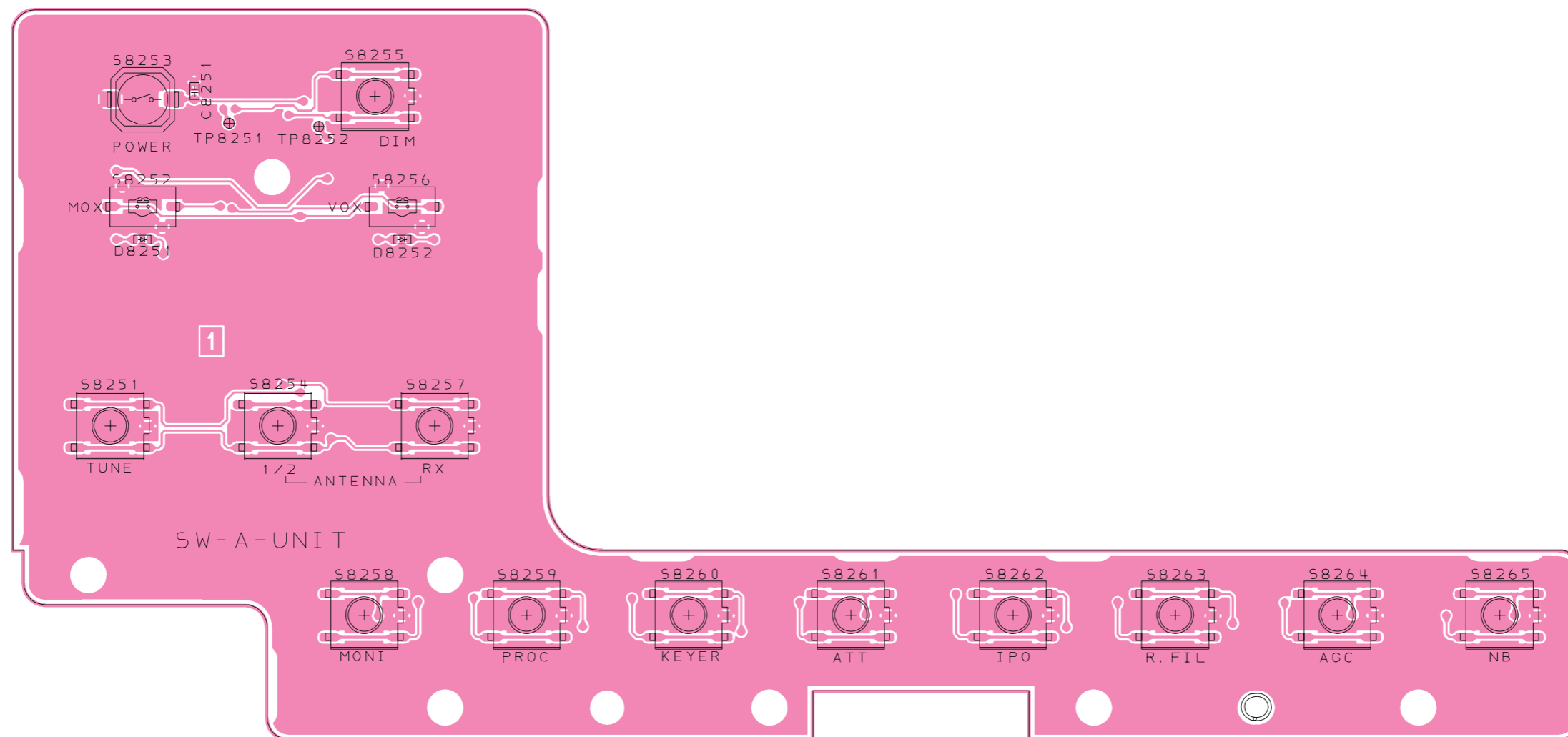

SW-A Unit

Parts Layout (Side B)

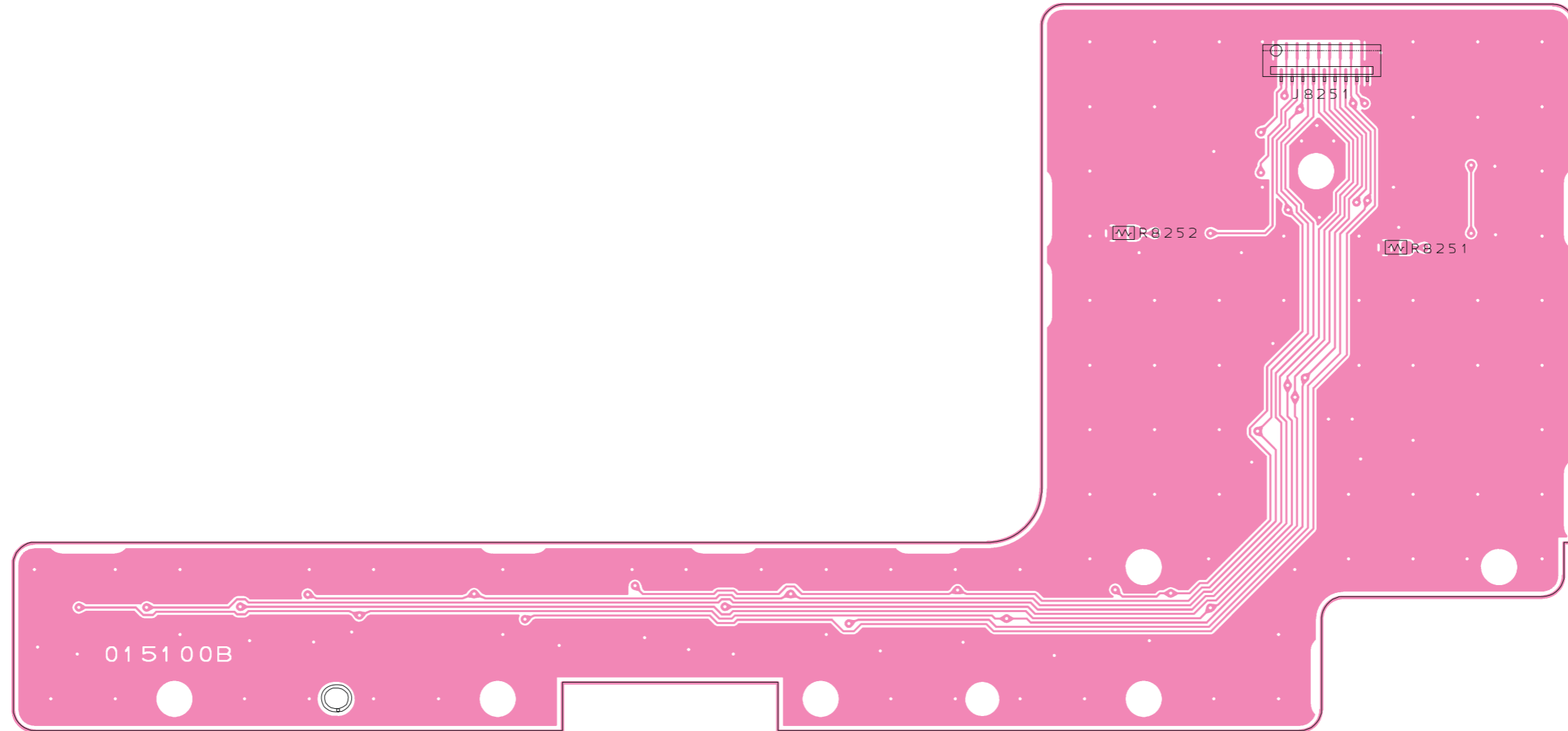

SW-A Unit

Parts List

REF	DESCRIPTION	VALUE	V/W	TOL.	MFR'S DESIG	VXSTD P/N	VERS.	LOT	SIDE	LAY ADR
PCB with Components						CB3631001				
Printed Circuit Board						AH025H000	FR0151000		1-	
D 8251	LED				SML-310VTT86JK	G2071032		1-	A	
D 8252	LED				SML-310VTT86JK	G2071032		1-	A	
J 8251	CONNECTOR				18FLT-SM1-TB	P1091176		1-	B	
R 8251	CHIP RES.	1k	1/16W	5%	RMC1/16 102JATP	J24185102		1-	B	
R 8251	CHIP RES.	1k	1/10W	5%	RMC1/10T 102J	J24205102		4-	B	
R 8252	CHIP RES.	1k	1/16W	5%	RMC1/16 102JATP	J24185102		1-	B	
R 8252	CHIP RES.	1k	1/10W	5%	RMC1/10T 102J	J24205102		4-	B	
S 8251	TACT SWITCH				SKHUPDE010	N5090126		1-	A	
S 8252	TACT SWITCH				SKQYPAE010	N5090144		1-	A	
S 8253	TACT SWITCH				SKPMAPE010	N5090139		1-	A	
S 8254	TACT SWITCH				SKHUPDE010	N5090126		1-	A	
S 8255	TACT SWITCH				SKHUPDE010	N5090126		1-	A	
S 8256	TACT SWITCH				SKQYPAE010	N5090144		1-	A	
S 8257	TACT SWITCH				SKHUPDE010	N5090126		1-	A	
S 8258	TACT SWITCH				SKHUPDE010	N5090126		1-	A	
S 8259	TACT SWITCH				SKHUPDE010	N5090126		1-	A	
S 8260	TACT SWITCH				SKHUPDE010	N5090126		1-	A	
S 8261	TACT SWITCH				SKHUPDE010	N5090126		1-	A	
S 8262	TACT SWITCH				SKHUPDE010	N5090126		1-	A	
S 8263	TACT SWITCH				SKHUPDE010	N5090126		1-	A	
S 8264	TACT SWITCH				SKHUPDE010	N5090126		1-	A	
S 8265	TACT SWITCH				SKHUPDE010	N5090126		1-	A	

SW-A Unit

Note:

MIC Unit

Circuit Diagram

MIC-UNIT (BR0 15 1 10A)

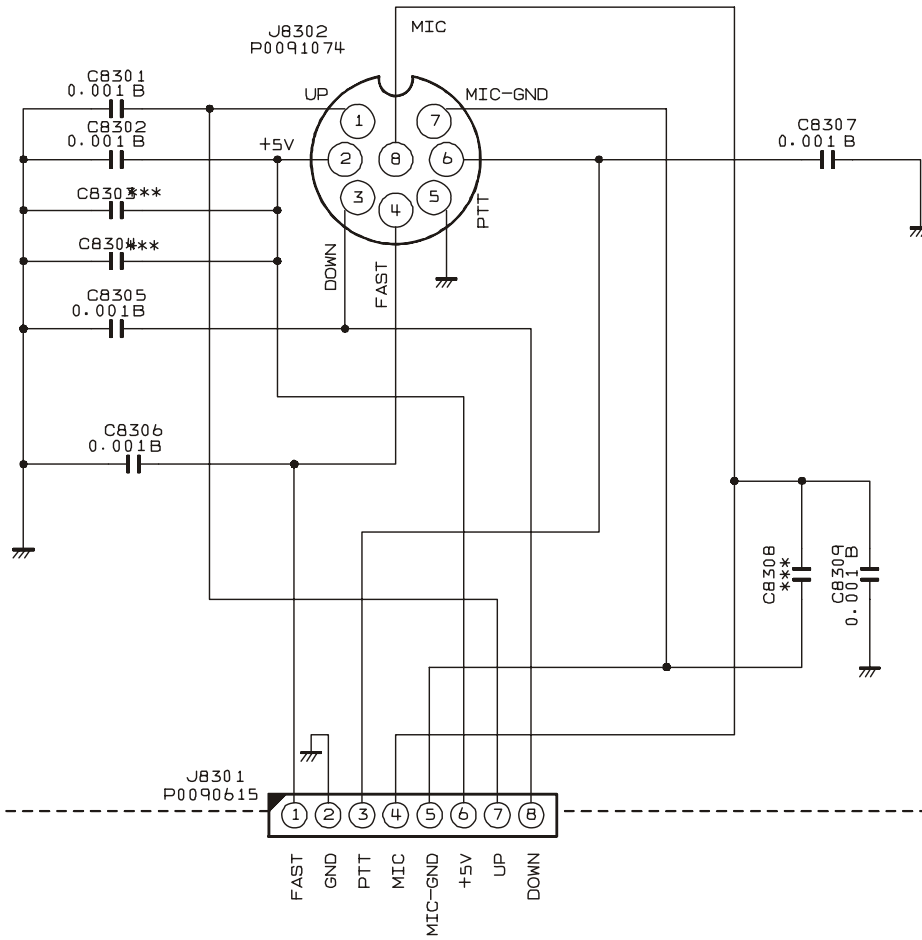

-- TO MAIN-UNIT --

MIC Unit

Parts Layout

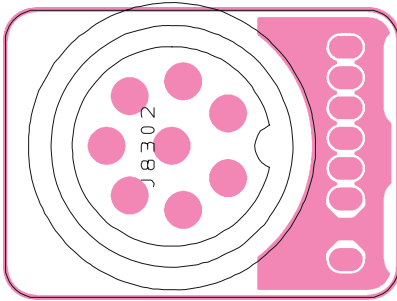

Side A

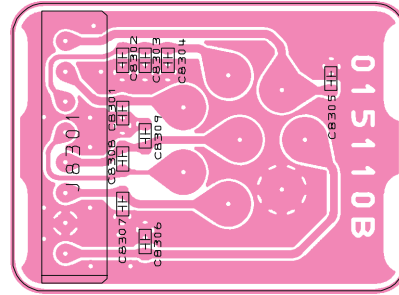

Side B

Parts List

REF	DESCRIPTION	VALUE	V/W	TOL.	MFR'S DESIG	VXSTD P/N	VERS.	LOT	SIDE	LAY ADR
	PCB with Components					CB3632001				
	Printed Circuit Board					AH025H000	FR0151100		1-	
C 8301	CHIP CAP.	0.001uF	50V	B	GRM188B11H102KA01D	K22174809		1-	B	
C 8302	CHIP CAP.	0.001uF	50V	B	GRM188B11H102KA01D	K22174809		1-	B	
C 8305	CHIP CAP.	0.001uF	50V	B	GRM188B11H102KA01D	K22174809		1-	B	
C 8306	CHIP CAP.	0.001uF	50V	B	GRM188B11H102KA01D	K22174809		1-	B	
C 8307	CHIP CAP.	0.001uF	50V	B	GRM188B11H102KA01D	K22174809		1-	B	
C 8309	CHIP CAP.	0.001uF	50V	B	GRM188B11H102KA01D	K22174809		1-	B	
J 8301	CONNECTOR				SB20-08WS	P0090615		1-	B	
J 8302	CONNECTOR				FM214-8SMPT-NI	P0091074		1-	A	

JACK Unit

Circuit Diagram

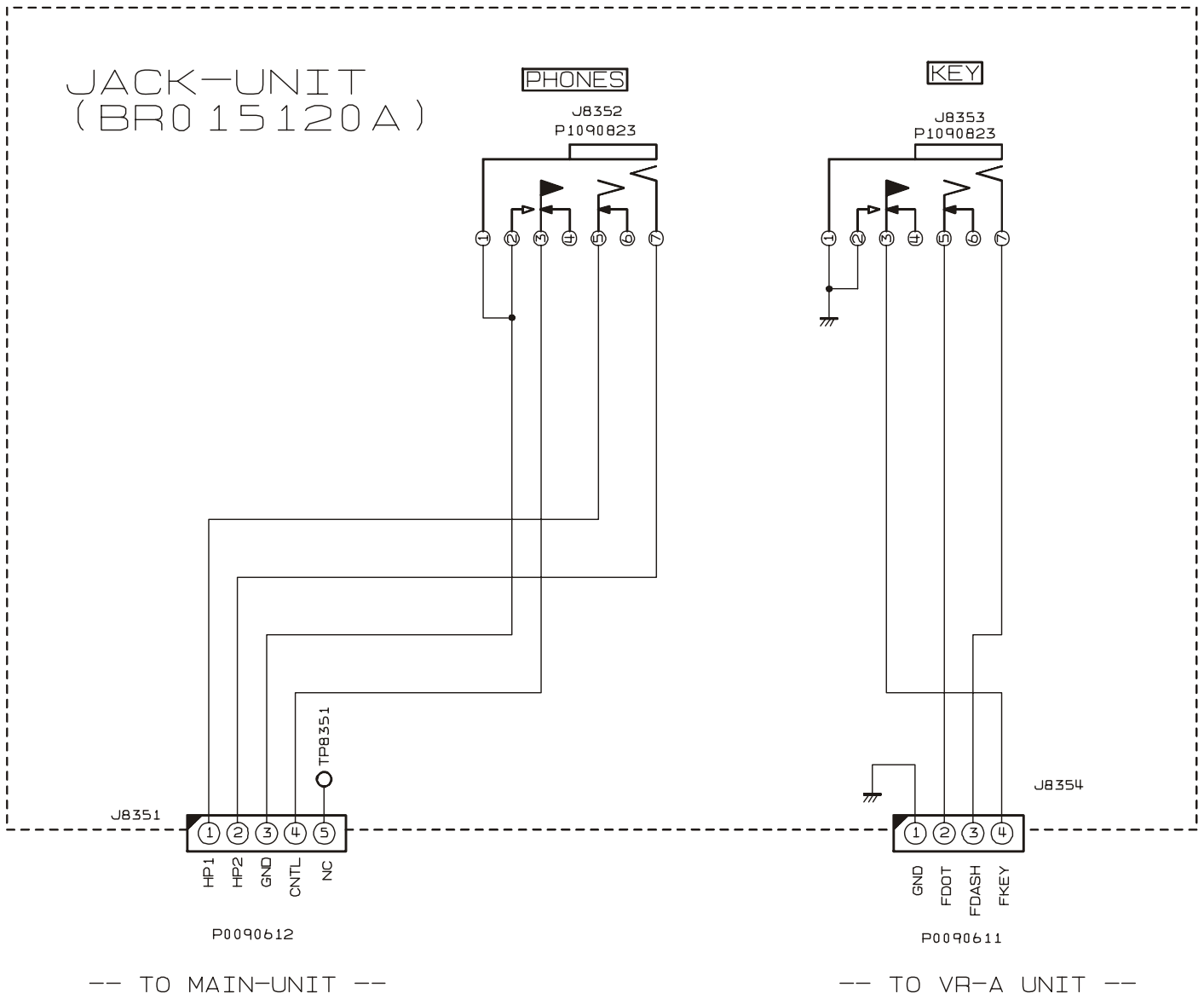

JACK Unit

Parts Layout

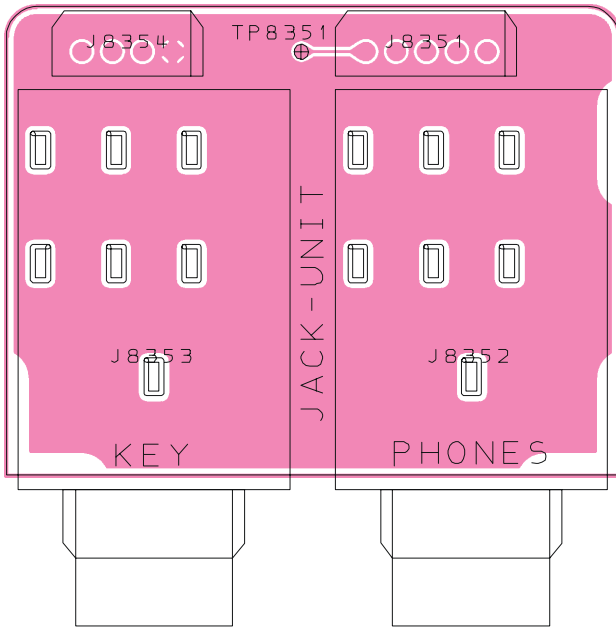

Side A

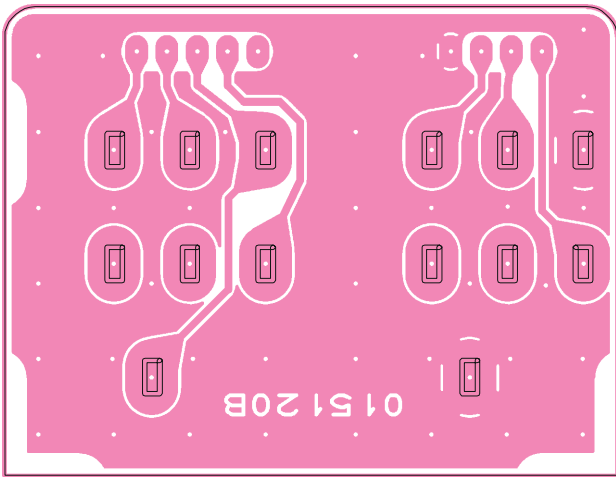

Side B

Parts List

REF	DESCRIPTION	VALUE	V/W	TOL.	MFR'S DESIG	VXSTD P/N	VERS.	LOT	SIDE	LAY ADR
	PCB with Components					CB3633001				
PB8351	Printed Circuit Board				AH025H000	FR015120B		1-		
J 8351	CONNECTOR				SB20-05WS	P0090612		1-	A	
J 8352	CONNECTOR				HLJ2305-0130609	P1090823		1-	A	
J 8353	CONNECTOR				HLJ2305-0130609	P1090823		1-	A	
J 8354	CONNECTOR				SB20-04WS	P0090611		1-	A	

Provided by YAESU museum
Downloaded by RadioAmateur.EU

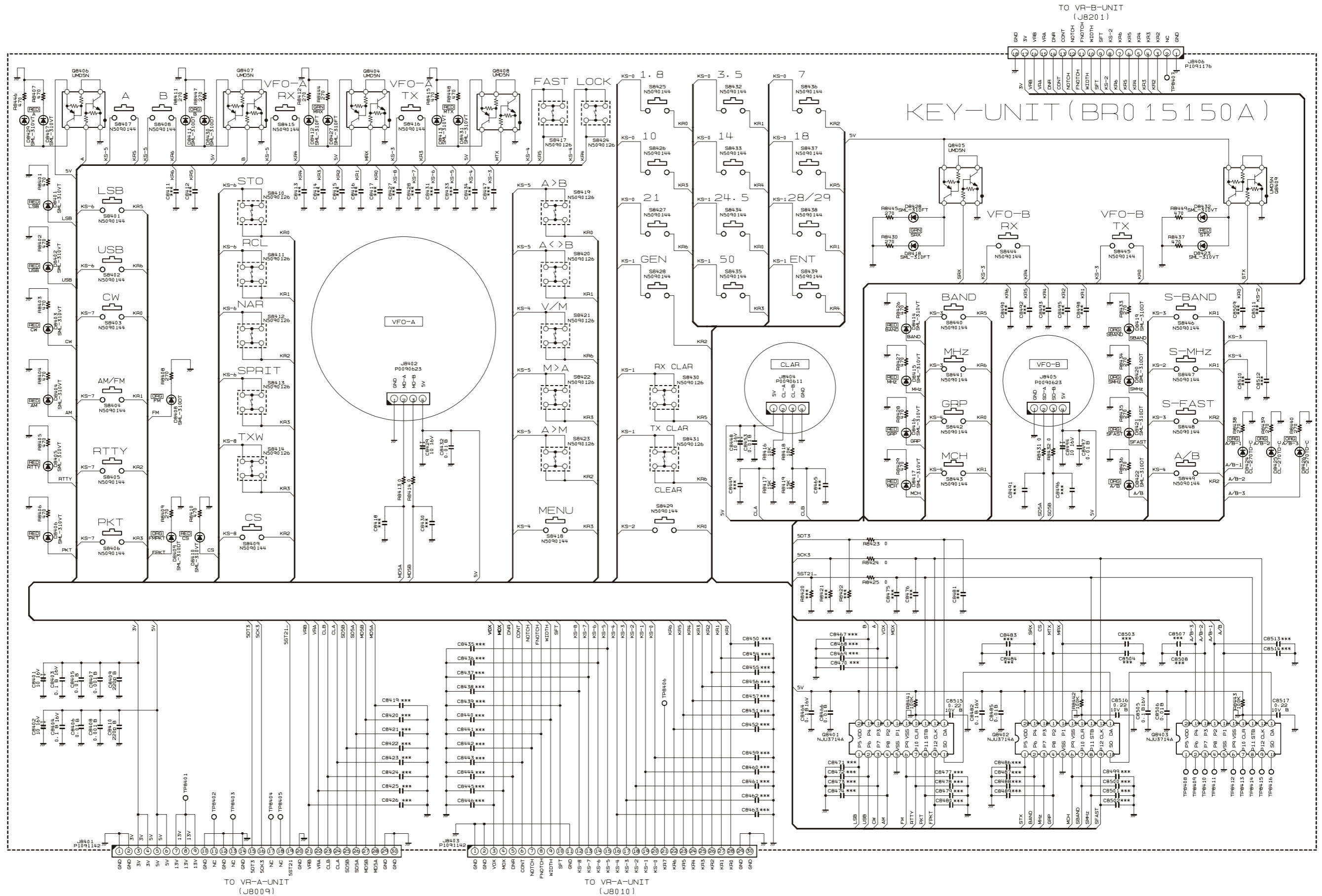

KEY Unit

Note

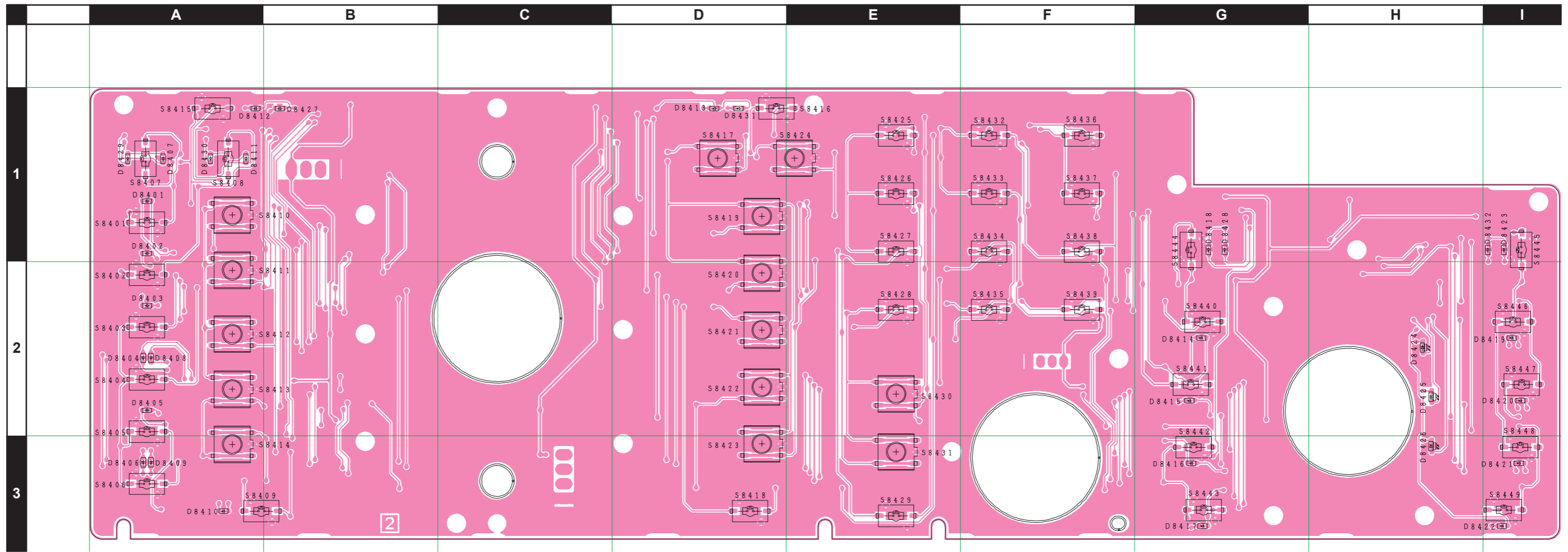

KEY Unit

Parts Layout (Side B)

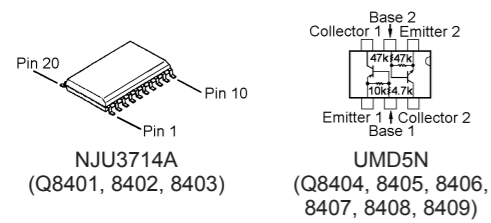
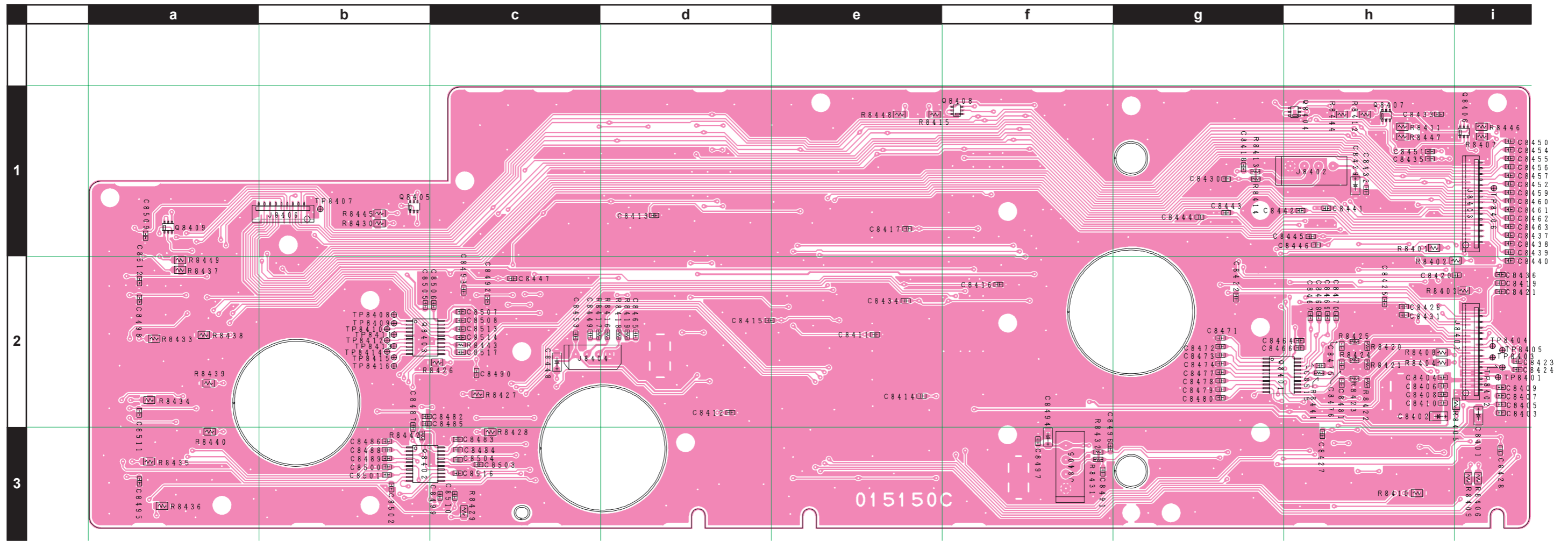

KEY Unit

Parts List

REF	DESCRIPTION	VALUE	V/W	TOL.	MFR'S DESIG	VXSTD P/N	VERS.	LOT	SIDE	LAY ADR	
PCB with Components						CB3653001					
Printed Circuit Board						AH025H000	FR0151500		1-		
C 8401	CHIP TA.CAP.	10uF	16V		TEESVA1C106M8R	K78120077		1-	B	i2	
C 8402	CHIP TA.CAP.	10uF	16V		TEESVA1C106M8R	K78120077		1-	B	h2	
C 8403	CHIP CAP.	0.1uF	16V	B	GRM188B11C104KA01D	K22124805		1-	B	i2	
C 8404	CHIP CAP.	0.1uF	16V	B	GRM188B11C104KA01D	K22124805		1-	B	h2	
C 8405	CHIP CAP.	0.01uF	50V	B	GRM188B11H103KA01D	K22174823		1-	B	i2	
C 8406	CHIP CAP.	0.01uF	50V	B	GRM188B11H103KA01D	K22174823		1-	B	h2	
C 8407	CHIP CAP.	0.001uF	50V	B	GRM188B11H102KA01D	K22174809		1-	B	i2	
C 8408	CHIP CAP.	0.001uF	50V	B	GRM188B11H102KA01D	K22174809		1-	B	h2	
C 8409	CHIP CAP.	220pF	50V	B	GRM188B11H221KA01D	K22174801		1-	B	i2	
C 8410	CHIP CAP.	220pF	50V	B	GRM188B11H221KA01D	K22174801		1-	B	h2	
C 8429	CHIP TA.CAP.	10uF	16V		TEESVA1C106M8R	K78120077		1-	B	h1	
C 8432	CHIP CAP.	0.01uF	50V	B	GRM188B11H103KA01D	K22174823		1-	B	h1	
C 8448	CHIP TA.CAP.	10uF	16V		TEESVA1C106M8R	K78120077		1-	B	c2	
C 8453	CHIP CAP.	0.01uF	50V	B	GRM188B11H103KA01D	K22174823		1-	B	c2	
C 8464	CHIP CAP.	0.1uF	16V	B	GRM188B11C104KA01D	K22124805		1-	B	h2	
C 8466	CHIP CAP.	0.01uF	50V	B	GRM188B11H103KA01D	K22174823		1-	B	h2	
C 8482	CHIP CAP.	0.1uF	16V	B	GRM188B11C104KA01D	K22124805		1-	B	b2	
C 8485	CHIP CAP.	0.01uF	50V	B	GRM188B11H103KA01D	K22174823		1-	B	b2	
C 8494	CHIP TA.CAP.	10uF	16V		TEESVA1C106M8R	K78120077		1-	B	f3	
C 8497	CHIP CAP.	0.01uF	50V	B	GRM188B11H103KA01D	K22174823		1-	B	f3	
C 8505	CHIP CAP.	0.1uF	16V	B	GRM188B11C104KA01D	K22124805		1-	B	b2	
C 8506	CHIP CAP.	0.01uF	50V	B	GRM188B11H103KA01D	K22174823		1-	B	c2	
C 8515	CHIP CAP.	0.22uF	10V	B	GRM188B11A224KA01D	K22104801		1-	B	h2	
C 8516	CHIP CAP.	0.22uF	10V	B	GRM188B11A224KA01D	K22104801		1-	B	c3	
C 8517	CHIP CAP.	0.22uF	10V	B	GRM188B11A224KA01D	K22104801		1-	B	c2	
D 8401	LED				SML-310VTT86JK	G2071032		1-	A	A1	
D 8402	LED				SML-310VTT86JK	G2071032		1-	A	A1	
D 8403	LED				SML-310VTT86JK	G2071032		1-	A	A2	
D 8404	LED				SML-310VTT86JK	G2071032		1-	A	A2	
D 8405	LED				SML-310VTT86JK	G2071032		1-	A	A2	
D 8406	LED				SML-310VTT86JK	G2071032		1-	A	A3	
D 8407	LED				SML-310VTT86JK	G2071032		1-	A	A1	
D 8408	LED				SML-310DTT86KL	G2071024		1-	A	A2	
D 8409	LED				SML-310DTT86KL	G2071024		1-	A	A3	
D 8410	LED				SML-310VTT86JK	G2071032		1-	A	A3	
D 8411	LED				SML-310DTT86KL	G2071024		1-	A	A1	
D 8412	LED				SML-310FTT86KL	G2071026		1-	A	A1	
D 8413	LED				SML-310VTT86JK	G2071032		1-	A	D1	
D 8414	LED				SML-310VTT86JK	G2071032		1-	A	G2	
D 8415	LED				SML-310VTT86JK	G2071032		1-	A	G2	
D 8416	LED				SML-310VTT86JK	G2071032		1-	A	G3	
D 8417	LED				SML-310VTT86JK	G2071032		1-	A	G3	
D 8418	LED				SML-310FTT86KL	G2071026		1-	A	G1	
D 8419	LED				SML-310DTT86KL	G2071024		1-	A	I2	
D 8420	LED				SML-310DTT86KL	G2071024		1-	A	I2	
D 8421	LED				SML-310DTT86KL	G2071024		1-	A	I3	
D 8422	LED				SML-310DTT86KL	G2071024		1-	A	I3	
D 8423	LED				SML-310VTT86JK	G2071032		1-	A	I1	
D 8424	LED				CL-270TD-C-TS	G2070930		1-	A	H2	
D 8425	LED				CL-270TD-C-TS	G2070930		1-	A	H2	
D 8426	LED				CL-270TD-C-TS	G2070930		1-	A	H3	
D 8427	LED				SML-310FTT86KL	G2071026		1-	A	B1	
D 8428	LED				SML-310FTT86KL	G2071026		1-	A	G1	
D 8429	LED				SML-310VTT86JK	G2071032		1-	A	A1	
D 8430	LED				SML-310DTT86KL	G2071024		1-	A	A1	
D 8431	LED				SML-310VTT86JK	G2071032		1-	A	D1	
D 8432	LED				SML-310VTT86JK	G2071032		1-	A	I1	
J 8401	CONNECTOR				30FLT-SM1-TB	P1091142		1-	B	i2	
J 8402	CONNECTOR				SC25-04WS	P0090623		1-	B	h1	
J 8403	CONNECTOR				30FLT-SM1-TB	P1091142		1-	B	i1	
J 8404	CONNECTOR				SB20-04WS	P0090611		1-	B	c2	
J 8405	CONNECTOR				SC25-04WS	P0090623		1-	B	f3	
J 8406	CONNECTOR				18FLT-SM1-TB	P1091176		1-	B	b1	
Q 8401	IC				NJU3714A(TAPE)	G1094291		1-	B	g2	
Q 8402	IC				NJU3714A(TAPE)	G1094291		1-	B	b3	
Q 8403	IC				NJU3714A(TAPE)	G1094291		1-	B	b2	
Q 8404	TRANSISTOR				UMD5N TR	G3070343		1-	B	h1	
Q 8405	TRANSISTOR				UMD5N TR	G3070343		1-	B	b1	
Q 8406	TRANSISTOR				UMD5N TR	G3070343		1-	B	i1	
Q 8407	TRANSISTOR				UMD5N TR	G3070343		1-	B	h1	
Q 8408	TRANSISTOR				UMD5N TR	G3070343		1-	B	f1	

KEY Unit

Parts List

REF	DESCRIPTION	VALUE	V/W	TOL.	MFR'S DESIG	VXSTD P/N	VERS.	LOT	SIDE	LAY ADR
Q 8409	TRANSISTOR				UMD5N TR	G3070343		1-	B	a1
R 8401	CHIP RES.	470	1/10W	5%	RMC1/10T 471J	J24205471		1-	B	h1
R 8402	CHIP RES.	470	1/10W	5%	RMC1/10T 471J	J24205471		1-	B	i2
R 8403	CHIP RES.	470	1/10W	5%	RMC1/10T 471J	J24205471		1-	B	i2
R 8404	CHIP RES.	470	1/10W	5%	RMC1/10T 471J	J24205471		1-	B	h2
R 8405	CHIP RES.	470	1/10W	5%	RMC1/10T 471J	J24205471		1-	B	i2
R 8406	CHIP RES.	470	1/10W	5%	RMC1/10T 471J	J24205471		1-	B	i3
R 8407	CHIP RES.	820	1/10W	5%	RMC1/10T 821J	J24205821		1-	B	i1
R 8408	CHIP RES.	270	1/10W	5%	RMC1/10T 271J	J24205271		1-	B	h2
R 8409	CHIP RES.	270	1/10W	5%	RMC1/10T 271J	J24205271		1-	B	i3
R 8410	CHIP RES.	470	1/10W	5%	RMC1/10T 471J	J24205471		1-	B	h3
R 8411	CHIP RES.	270	1/10W	5%	RMC1/10T 271J	J24205271		1-	B	h1
R 8412	CHIP RES.	270	1/10W	5%	RMC1/10T 271J	J24205271		1-	B	h1
R 8413	CHIP RES.	0	1/16W	5%	RMC1/16 000JATP	J24185000		1-	B	g1
R 8414	CHIP RES.	0	1/16W	5%	RMC1/16 000JATP	J24185000		1-	B	g1
R 8415	CHIP RES.	470	1/10W	5%	RMC1/10T 471J	J24205471		1-	B	e1
R 8416	CHIP RES.	10k	1/16W	5%	RMC1/16 103JATP	J24185103		1-	B	d2
R 8417	CHIP RES.	15k	1/16W	5%	RMC1/16 153JATP	J24185153		1-	B	c2
R 8418	CHIP RES.	10k	1/16W	5%	RMC1/16 103JATP	J24185103		1-	B	d2
R 8419	CHIP RES.	15k	1/16W	5%	RMC1/16 153JATP	J24185153		1-	B	d2
R 8423	CHIP RES.	0	1/16W	5%	RMC1/16 000JATP	J24185000		1-	B	h2
R 8424	CHIP RES.	0	1/16W	5%	RMC1/16 000JATP	J24185000		1-	B	h2
R 8425	CHIP RES.	0	1/16W	5%	RMC1/16 000JATP	J24185000		1-	B	h2
R 8426	CHIP RES.	470	1/10W	5%	RMC1/10T 471J	J24205471		1-	B	c2
R 8427	CHIP RES.	470	1/10W	5%	RMC1/10T 471J	J24205471		1-	B	c2
R 8428	CHIP RES.	470	1/10W	5%	RMC1/10T 471J	J24205471		1-	B	c3
R 8429	CHIP RES.	470	1/10W	5%	RMC1/10T 471J	J24205471		1-	B	c3
R 8430	CHIP RES.	270	1/10W	5%	RMC1/10T 271J	J24205271		1-	B	b1
R 8431	CHIP RES.	0	1/16W	5%	RMC1/16 000JATP	J24185000		1-	B	f3
R 8432	CHIP RES.	0	1/16W	5%	RMC1/16 000JATP	J24185000		1-	B	f3
R 8433	CHIP RES.	270	1/10W	5%	RMC1/10T 271J	J24205271		1-	B	a2
R 8434	CHIP RES.	270	1/10W	5%	RMC1/10T 271J	J24205271		1-	B	a2
R 8435	CHIP RES.	270	1/10W	5%	RMC1/10T 271J	J24205271		1-	B	a3
R 8436	CHIP RES.	270	1/10W	5%	RMC1/10T 271J	J24205271		1-	B	a3
R 8437	CHIP RES.	470	1/10W	5%	RMC1/10T 471J	J24205471		1-	B	a2
R 8438	CHIP RES.	1k	1/10W	5%	RMC1/10T 102J	J24205102		1-	B	a2
R 8439	CHIP RES.	1k	1/10W	5%	RMC1/10T 102J	J24205102		1-	B	a2
R 8440	CHIP RES.	1k	1/10W	5%	RMC1/10T 102J	J24205102		1-	B	a3
R 8441	CHIP RES.	100k	1/16W	5%	RMC1/16 104JATP	J24185104		1-	B	h2
R 8442	CHIP RES.	100k	1/16W	5%	RMC1/16 104JATP	J24185104		1-	B	b3
R 8443	CHIP RES.	100k	1/16W	5%	RMC1/16 104JATP	J24185104		1-	B	c2
R 8444	CHIP RES.	270	1/10W	5%	RMC1/10T 271J	J24205271		1-	B	h1
R 8445	CHIP RES.	270	1/10W	5%	RMC1/10T 271J	J24205271		1-	B	b1
R 8446	CHIP RES.	820	1/10W	5%	RMC1/10T 821J	J24205821		1-	B	i1
R 8447	CHIP RES.	270	1/10W	5%	RMC1/10T 271J	J24205271		1-	B	h1
R 8448	CHIP RES.	470	1/10W	5%	RMC1/10T 471J	J24205471		1-	B	e1
R 8449	CHIP RES.	470	1/10W	5%	RMC1/10T 471J	J24205471		1-	B	a2
S 8401	TACT SWITCH				SKQYPAE010	N5090144		1-	A	A1
S 8402	TACT SWITCH				SKQYPAE010	N5090144		1-	A	A2
S 8403	TACT SWITCH				SKQYPAE010	N5090144		1-	A	A2
S 8404	TACT SWITCH				SKQYPAE010	N5090144		1-	A	A2
S 8405	TACT SWITCH				SKQYPAE010	N5090144		1-	A	A2
S 8406	TACT SWITCH				SKQYPAE010	N5090144		1-	A	A3
S 8407	TACT SWITCH				SKQYPAE010	N5090144		1-	A	A1
S 8408	TACT SWITCH				SKQYPAE010	N5090144		1-	A	A1
S 8409	TACT SWITCH				SKQYPAE010	N5090144		1-	A	A3
S 8410	TACT SWITCH				SKHUPDE010	N5090126		1-	A	A1
S 8411	TACT SWITCH				SKHUPDE010	N5090126		1-	A	A2
S 8412	TACT SWITCH				SKHUPDE010	N5090126		1-	A	A2
S 8413	TACT SWITCH				SKHUPDE010	N5090126		1-	A	A2
S 8414	TACT SWITCH				SKHUPDE010	N5090126		1-	A	A3
S 8415	TACT SWITCH				SKQYPAE010	N5090144		1-	A	A1
S 8416	TACT SWITCH				SKQYPAE010	N5090144		1-	A	D1
S 8417	TACT SWITCH				SKHUPDE010	N5090126		1-	A	D1
S 8418	TACT SWITCH				SKQYPAE010	N5090144		1-	A	D3
S 8419	TACT SWITCH				SKHUPDE010	N5090126		1-	A	D1
S 8420	TACT SWITCH				SKHUPDE010	N5090126		1-	A	D2
S 8421	TACT SWITCH				SKHUPDE010	N5090126		1-	A	D2
S 8422	TACT SWITCH				SKHUPDE010	N5090126		1-	A	D2
S 8423	TACT SWITCH				SKHUPDE010	N5090126		1-	A	D3
S 8424	TACT SWITCH				SKHUPDE010	N5090126		1-	A	E1
S 8425	TACT SWITCH				SKQYPAE010	N5090144		1-	A	E1
S 8425	TACT SWITCH				SKQYPBE010	N5090155		4-	A	E1

KEY Unit

Parts List

REF	DESCRIPTION	VALUE	V/W	TOL.	MFR'S DESIG	VXSTD P/N	VERS.	LOT	SIDE	LAY ADR
S 8426	TACT SWITCH				SKQYPAE010	N5090144		1-	A	E1
S 8426	TACT SWITCH				SKQYPBE010	N5090155		4-	A	E1
S 8427	TACT SWITCH				SKQYPAE010	N5090144		1-	A	E1
S 8427	TACT SWITCH				SKQYPBE010	N5090155		4-	A	E1
S 8428	TACT SWITCH				SKQYPAE010	N5090144		1-	A	E2
S 8428	TACT SWITCH				SKQYPBE010	N5090155		4-	A	E2
S 8429	TACT SWITCH				SKQYPAE010	N5090144		1-	A	E3
S 8430	TACT SWITCH				SKHUPDE010	N5090126		1-	A	E2
S 8431	TACT SWITCH				SKHUPDE010	N5090126		1-	A	E3
S 8432	TACT SWITCH				SKQYPAE010	N5090144		1-	A	F1
S 8432	TACT SWITCH				SKQYPBE010	N5090155		4-	A	F1
S 8433	TACT SWITCH				SKQYPAE010	N5090144		1-	A	F1
S 8433	TACT SWITCH				SKQYPBE010	N5090155		4-	A	F1
S 8434	TACT SWITCH				SKQYPAE010	N5090144		1-	A	F1
S 8434	TACT SWITCH				SKQYPBE010	N5090155		4-	A	F1
S 8435	TACT SWITCH				SKQYPAE010	N5090144		1-	A	F2
S 8435	TACT SWITCH				SKQYPBE010	N5090155		4-	A	F2
S 8436	TACT SWITCH				SKQYPAE010	N5090144		1-	A	F1
S 8436	TACT SWITCH				SKQYPBE010	N5090155		4-	A	F1
S 8437	TACT SWITCH				SKQYPAE010	N5090144		1-	A	F1
S 8437	TACT SWITCH				SKQYPBE010	N5090155		4-	A	F1
S 8438	TACT SWITCH				SKQYPAE010	N5090144		1-	A	F1
S 8438	TACT SWITCH				SKQYPBE010	N5090155		4-	A	F1
S 8439	TACT SWITCH				SKQYPAE010	N5090144		1-	A	F2
S 8439	TACT SWITCH				SKQYPBE010	N5090155		4-	A	F2
S 8440	TACT SWITCH				SKQYPAE010	N5090144		1-	A	G2
S 8441	TACT SWITCH				SKQYPAE010	N5090144		1-	A	G2
S 8442	TACT SWITCH				SKQYPAE010	N5090144		1-	A	G3
S 8443	TACT SWITCH				SKQYPAE010	N5090144		1-	A	G3
S 8444	TACT SWITCH				SKQYPAE010	N5090144		1-	A	G1
S 8445	TACT SWITCH				SKQYPAE010	N5090144		1-	A	I1
S 8446	TACT SWITCH				SKQYPAE010	N5090144		1-	A	I2
S 8447	TACT SWITCH				SKQYPAE010	N5090144		1-	A	I2
S 8448	TACT SWITCH				SKQYPAE010	N5090144		1-	A	I3
S 8449	TACT SWITCH				SKQYPAE010	N5090144		1-	A	I3

KEY Unit

Note:

BACK-LIGHT Unit

Circuit Diagram

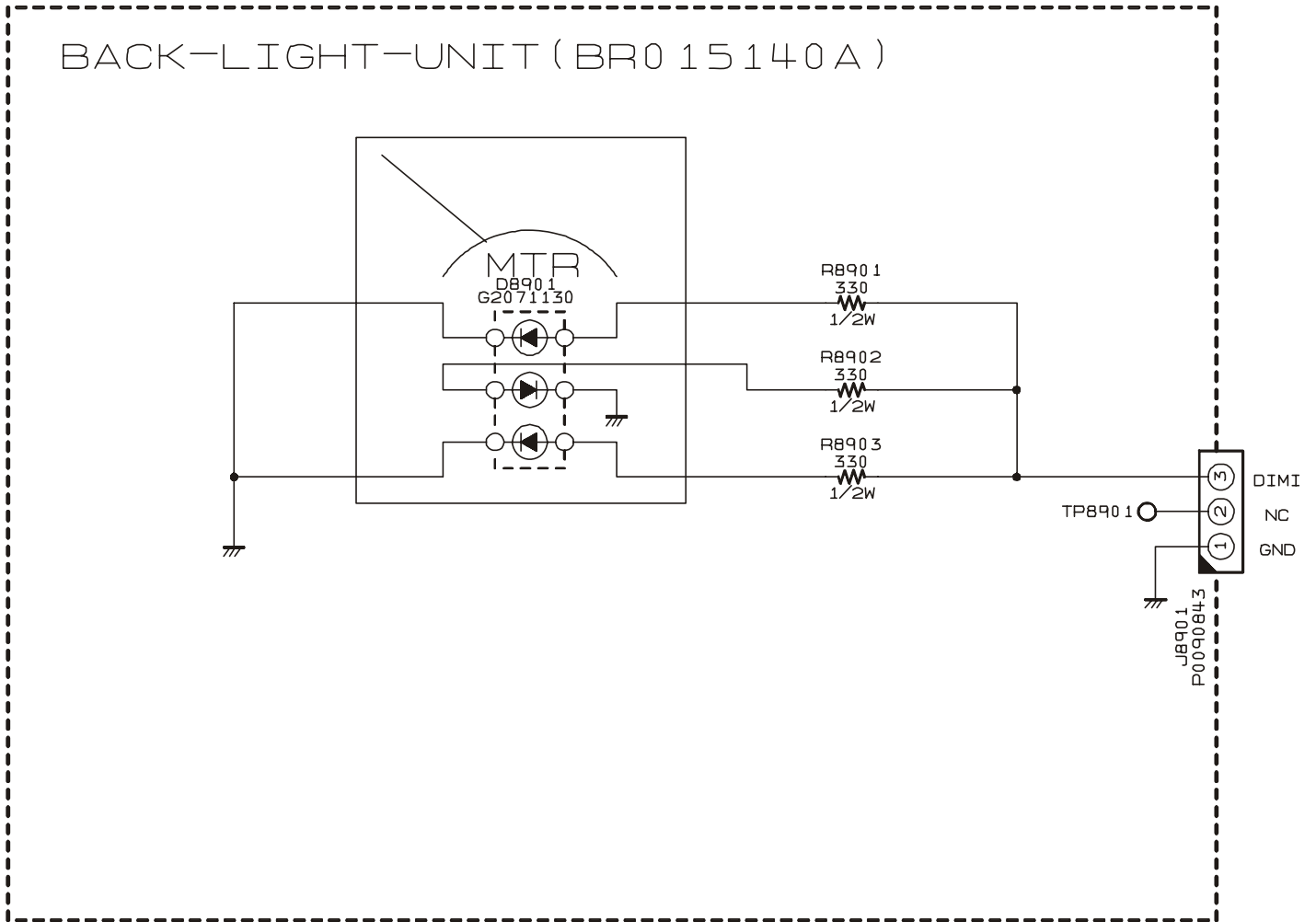

BACK-LIGHT Unit

Parts Layout

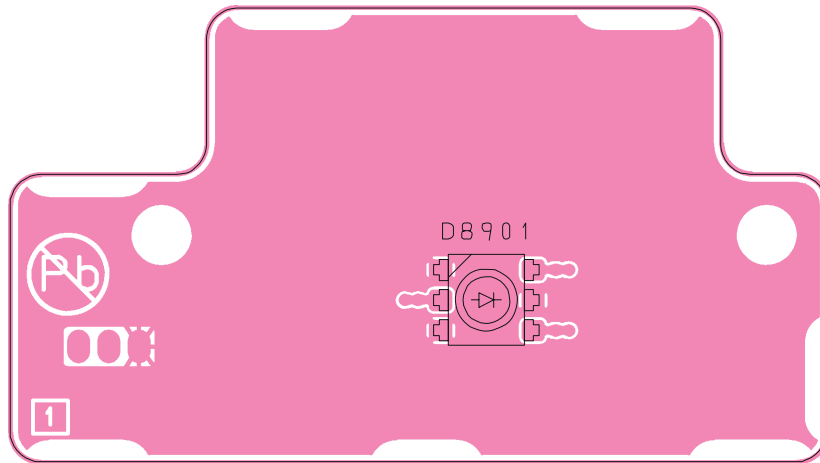

Side A

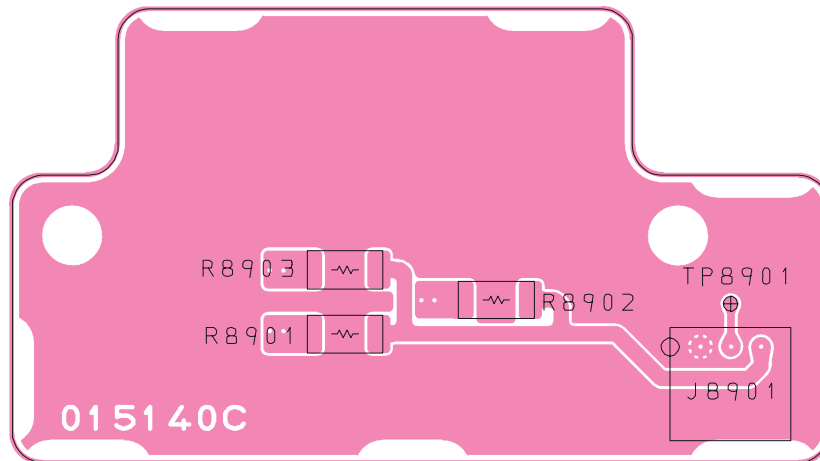

Side B

Parts List

REF	DESCRIPTION	VALUE	V/W	TOL.	MFR'S DESIG	VXSTD P/N	VERS.	LOT	SIDE	LAYADR
	PCB with Components					CB3635001				
	Printed Circuit Board				AH025H000	FR0151400		1-		
D 8901	LED				GM5BW01300A	G2071130		1-	A	
J 8901	CONNECTOR				SB20-03WL	P0090843		1-	B	
R 8901	CHIPRES.	2.2k	1/2W	5%	RMC1/2222JCTP	J24275222		1-	B	
R 8902	CHIPRES.	2.2k	1/2W	5%	RMC1/2222JCTP	J24275222		1-	B	
R 8903	CHIPRES.	2.2k	1/2W	5%	RMC1/2222JCTP	J24275222		1-	B	

F-CONNECT Unit

Circuit Diagram

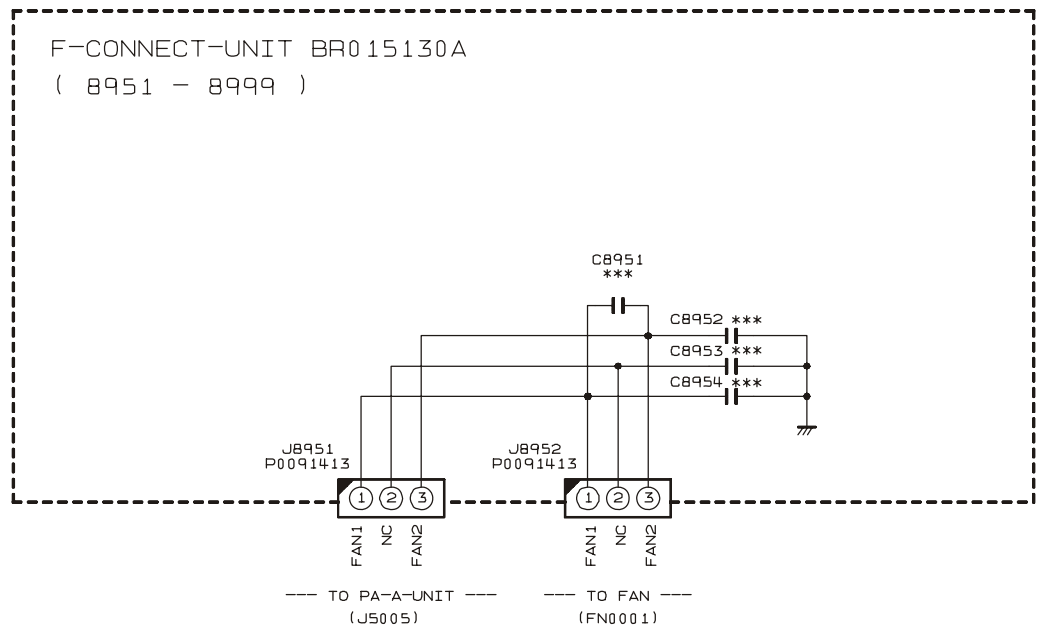

Parts Layout

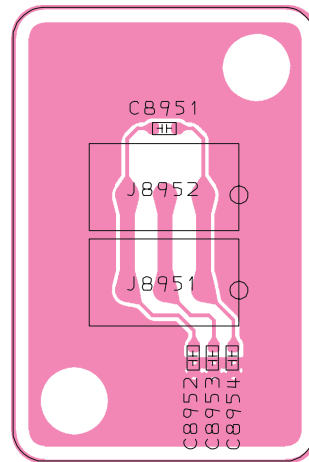

Side A

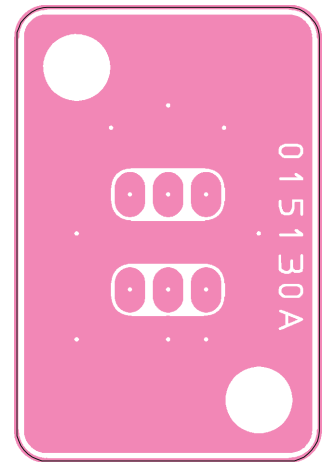

Side B

Parts List

REF	DESCRIPTION	VALUE	V/W	TOL.	MFR'S DESIG	VXSTD P/N	VERS.	LOT	SIDE	LAY ADR
	PCB with Components					CB3753001				
PB8951	Printed Circuit Board				AH025H000	FR0151300		1-		
J 8951	CONNECTOR				B03B-XH-A	P0091413		1-	A	
J 8952	CONNECTOR				B03B-XH-A	P0091413		1-	A	

F-CONNECT Unit

Note



Copyright 2006
VERTEX STANDARD CO., LTD.
All rights reserved

No portion of this manual
may be reproduced without
the permission of
VERTEX STANDARD CO., LTD.

Provided by
YAESU museum

Downloaded by
RadioAmateur.EU