INSTRUCTION MANUAL

EICO

710

GRID DIP
METER

710-2

The EICO logo is rendered in a stylized, italicized font with a thick black outline and a white fill. The letters are slanted to the right, giving it a sense of motion or precision. The logo is centered between two horizontal lines that extend outwards from the left and right sides of the logo.

131-01 39th Ave., Flushing, N. Y. 11352

MODEL 710

GRID DIP METER



general description

A grid-dip oscillator (g. d. o.) is basically a variable high frequency oscillator with a d-c microammeter in the grid return circuit to indicate relative power. The selected plug-in tank coil is mounted externally to serve as a "probe" that can be coupled appropriately to the circuit or source in question; a complete set of plug-in coils is provided to cover a wide range of frequencies from 400 kc to 250 mc. The tank capacitor is variable and calibrated for eight frequency ranges, one frequency range for every coil provided. As a g. d. o., the 710 can be used to determine the resonant frequency of de-energized resonant circuits or self-resonant components. Indirectly, therefore, it can also be used to determine values of capacitance, inductance, or Q by procedures that will be described. Since it is basically a v. f. o., the 710 may also be used as a signal or marker generator. By switching off the oscillator plate supply, the 710 becomes a tuned r-f diode detector with a meter in the diode load circuit. As such, it can be used to determine the frequency of rf energy sources. With the plate supply switched on again, but a headphone plugged into the phone jack, the 710 becomes an oscillating detector. This provides a very sensitive method for determining the frequency of unknown r-f energy sources, namely that of "beating" the unknown r-f energy picked up by the "probe" coil against the frequency generated by the internal variable oscillator.

SPECIFICATIONS

Frequency Range: 400 kc-250 mc in 8 overlapping ranges

Meter Movement: 500 microamperes.

Plug-in Coils: Wound to $\pm 0.5\%$ accuracy on polystyrene forms. Coil A - 400 to 700 kc; coil B - 700 to 1380 kc; coil C - 1380 to 2900 kc; coil D - 2.9 to 7.5 mc; coil E - 7.5 to 18 mc; coil F - 18 to 42 mc; coil G - 42 to 100 mc; coil H - 100 to 250 mc (hairpin).

Circuit: Exceptional stability is obtained with improved grid current stability over tuning range.

Tuning: Variable capacitor, equipped with planetary drive of 1:7 ratio.

Tube: 6AF4 (A) (Colpitts oscillator).

Scales: All the same length, 3 3/4" long, wrapped on cylindrical drum rotating through 340 degrees. Pilot lamp illuminates scales and edge-lights hairline engraved on plexiglass scale window.

Power Requirements: 117V 50/60 cy; 10 watts.

Power Supply: Transformer-operated selenium rectifier.

Dimensions: 2 1/4" high, 2-9/16" wide, 6 7/8" long.

Net Weight: 3 lbs.

Panel: Brushed satin aluminum, permanent acid-etched lettering.

Case: Steel, permanent gray wrinkle finish.

functions of controls

TUNING Control: Mechanically coupled to shaft of variable air capacitor. Determines the tuning frequency of the variable air capacitor and the plug-in "probe" coil.

OSCILLATOR-DIODE Switch: SPST switch in the oscillator plate voltage supply line. At **OSCILLATOR** position, B+ voltage is applied to the plate of the internal tube which then operates as an oscillator. At **DIODE** position, plate supply is disabled and the internal tube operates as a diode.

METER: Sensitive d-c microammeter in grid return circuit of oscillator tube to indicate relative power at the **OSCILLATOR** position of the **OSCILLATOR-DIODE** switch. In the diode load circuit to indicate relative value of detected r-f at the **DIODE** position of the **OSCILLATOR-DIODE** switch.

PHONE Jack: Intended to receive high impedance head-

phone (over 500 ohms), either crystal or magnetic. Inserting the phone plug automatically cuts out the meter with the phone taking its place in the circuit. Phone is an audio frequency signal indicator required for "zero-beat" comparison of internal and external frequencies, rather than a dc level indicator as is the meter.

SENSITIVITY Control: Rheostat, shunting meter or phone. Setting determines meter or phone sensitivity, which has to be adjustable to the conditions of use (degree of coupling, strength of signal, mode of operation, etc.).

ON-OFF Switch: Connects or disconnects instrument from a-c power line.

COIL Socket: Receives appropriate plug-in coil for desired range of frequencies.

operation

In all cases, the instrument takes operating power from the 105-125 volt, 50/60 cycle ac line and is turned on or off by the **ON-OFF** switch. The size and arrangement of controls permits one-handed operation and the meter is angled to permit observation in any position from vertical to horizontal.

WARNING: It is possible to receive a disabling or lethal shock when operating the grid-dip meter near high-voltage circuits should accidental contact of the probe coil or the instrument case to the high voltage circuit occur. Be extremely careful and observe all high voltage precautions.

1) **Grid-Dip Oscillator (g. d. o.):** Used to determine the resonant frequency of de-energized r-f circuits or self-resonant components such as coils and capacitors. The probe coil covering the expected frequency range is plugged into the coil socket and the **OSCILLATOR-DIODE** switch is thrown to **OSCILLATOR**. The 710 then becomes a variable high frequency oscillator with a d-c microammeter in the grid return circuit to indicate relative power. When the "probe" coil is coupled to an r-f circuit resonant in the frequency range covered by the particular coil, turning the **TUNING** control to the resonant frequency will be accompanied by a dip (decrease) in the meter reading due to the power absorbed by the resonant circuit. Before searching for the grid-dip, set the **SENSITIVITY** control for a mid-scale reading on the meter at the center of the frequency range, which will normally be satisfactory for a search over that particular band. In searching for the grid-dip, the meter reading will vary gradually as the **TUNING** control is turned, until the vicinity of the

correct frequency is reached. In this vicinity, a more or less sharp dip will occur, depending on the circuit Q. Read the frequency dial setting for the particular coil used at the lowest point of the dip. Note that no power is applied to the r-f circuit in question during g. d. o. operation. If there is some question as to whether the g. d. o. is measuring the resonant frequency of the desired tuned circuit in an equipment, vary the g. d. o. frequency until the grid dip is obtained; then moisten one finger and touch it to an ungrounded point in the circuit in question. No reaction in the g. d. o. meter means the resonance is of another circuit. Remember that power must be turned off before touching the test circuit. Another point worthy of note regards g. d. o. operation is that harmonics of lumped-constant networks will not show up. However, indication will sometimes occur of other resonant circuits formed by wiring, stray capacitances, etc., usually at a higher frequency. Harmonics of transmission lines and antennas will be indicated also.

2) **Tuned R-f Diode (t. r. f. diode):** (Also called non-oscillating detector, or absorption-type frequency meter). Used to determine the frequency of r-f energy in an energized r-f circuit. The probe coil covering the expected range is plugged into the coil socket and the **OSCILLATOR-DIODE** switch is thrown to **DIODE**. The 710 then becomes a tuned r-f diode detector or absorption-type frequency meter. The instrument meter is effectively in the diode load circuit and will read increasingly up-scale as the **TUNING** control is turned to the vicinity of the r-f frequency in question when the "probe" coil is coupled closely to the r-f energy source. The energy of the r-f

source must be at least 500,000 microvolts if this method of frequency determination is to be effective. Read the frequency dial setting for the particular coil used at the maximum meter reading. Use the SENSITIVITY control to keep the maximum meter reading on-scale. See methods of coupling.

3) Oscillating Detector: Another and more sensitive method used to determine the frequency of r-f energy. The probe coil covering the expected frequency range is plugged into the coil socket and the OSCILLATOR-DIODE switch is thrown to OSCILLATOR. A high impedance magnetic headphone is plugged into the PHONE jack which automatically cuts out the instrument meter. When the "probe" coil is suitably coupled to the unknown r-f energy source, the unknown r-f energy picked up mixes with the r-f energy in the instrument tank-circuit generated by the internal oscillator. A difference frequency equal to the difference between the external and internal frequencies is developed in the mixing and is called the

"beat" frequency. When the difference is very small, the "beat" frequency falls into the audible range and can be heard in the headphone. The "beat" note, or whistle, will drop in pitch as the external and internal frequencies are made to approach each other by varying either one as required. When one frequency is made to pass the other, the pitch of the "beat" note will rise again. The lowest pitched whistle corresponds to coincidence and is called "zero-beat", meaning a zero difference frequency. At high frequencies, the entire audible range is such a small fraction of the frequency in question, that the "zero-beat" is heard simply as a click in passing through coincidence. The oscillating detector method of frequency measurement is more sensitive than the t. r. f. diode method because the Q of the tank circuit is lowered by the diode.

4) Signal Marker Generator: With g. d. o. operation, the 710 can be used as a signal or marker generator, except where special shielding or a known r-f output voltage is required.

methods of coupling

Various proper methods of coupling are shown in Fig. 1. In any case, greatest frequency accuracy can be achieved by using the loosest possible coupling that gives sufficient indication.

Too close a coupling in g. d. o. operation is indicated by the dip occurring at a slightly different frequency when it is approached from the high frequency side than when it is approached from the low frequency side. It is therefore, desirable to check the dip frequency from both the high and low sides. However, a close coupling (e.g. 1/4 inch) is desirable at first to find the dip; a further aid

in finding the dip is to approach it from the frequency side on which the meter reading is generally rising, so that the dip is more noticeable when it occurs.

Too close a coupling in oscillating detector operation may cause the 710 oscillator to "lock in" with the external r-f source, thus defeating the measurement. This condition can be uncovered by rechecking the frequency of the "zero-beat" with a looser coupling. When using capacitive coupling, avoid, as much as possible, detuning of the circuit under investigation.



Fig. 1A. Preferred method (inductive coupling)

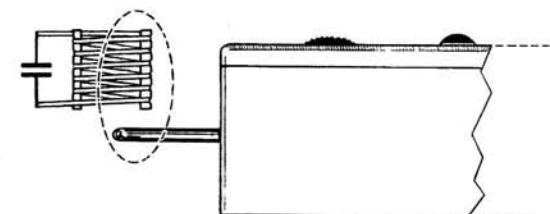

Fig. 1A'. High frequency hairpin coil inductively coupled at side

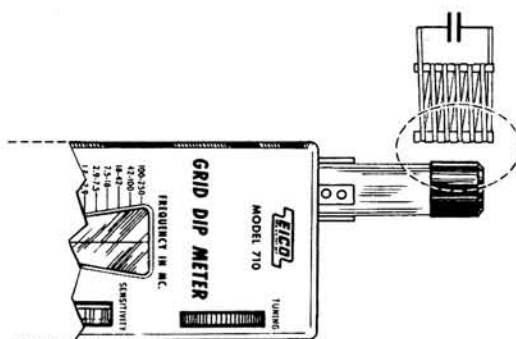

Fig. 1B. Alternate method of inductive coupling

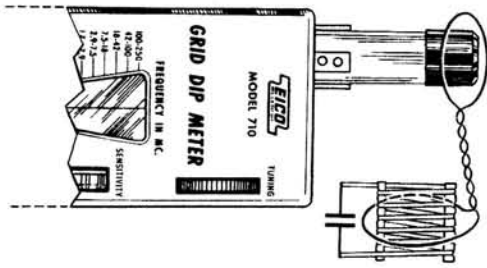

Fig. 1C. Link coupling for concealed or obstructed coil, or coils in a shielded can

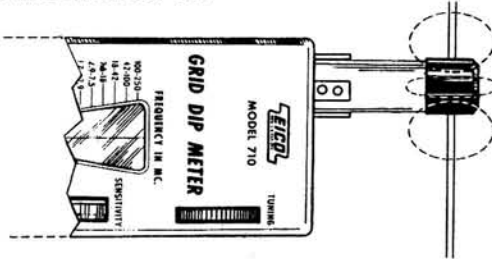

Fig. 1D. Inductive coupling to straight ungrounded wire or antenna

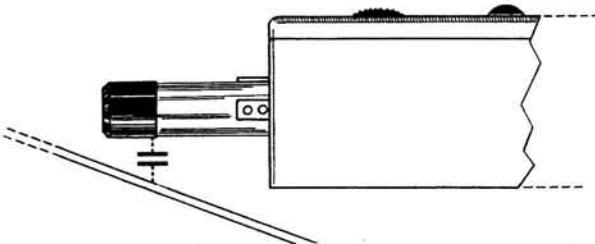

Fig. 1E. Capacitive coupling to ungrounded straight wire or antenna

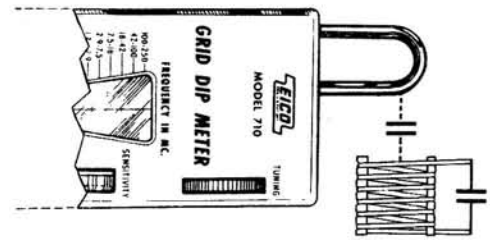

Fig. 1F. High frequency hairpin coil capacitively coupled to coil

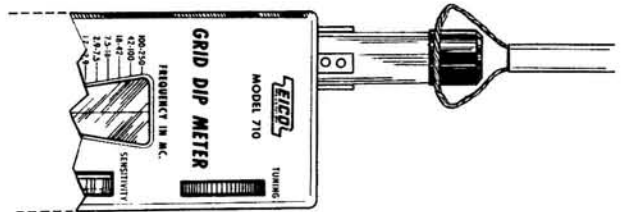

Fig. 1G. Inductive coupling to end of shorted parallel feeder line

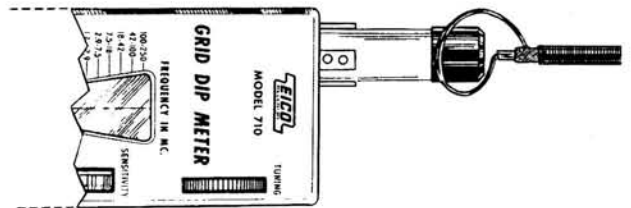

Fig. 1H. Inductive coupling to end of shorted co-axial line

applications

MEASURING AN UNKNOWN CAPACITY

The value of an unknown capacity between 50uuf and 5000uuf can be determined with the 710. The method is to connect the unknown capacitance across the F coil to create a resonant circuit. The 710 is then used as a g. d. o. with the C, D, or E coils plugged in, depending on the estimated capacity, to determine the resonant frequency. From the resonant frequency, the unknown capacity can be obtained from the graph of Fig. 3.

IMPORTANT NOTE: A suitable means has been provided to connect the unknown capacitance across the F coil. Two pin sockets with solder tabs are provided to which small alligator clips (not provided) should be soldered. A pin socket-&-clip arrangement is then fitted to each pin of the F coil. The pig-tail leads of the unknown capacitance are inserted in the alligator clips. **DO NOT**

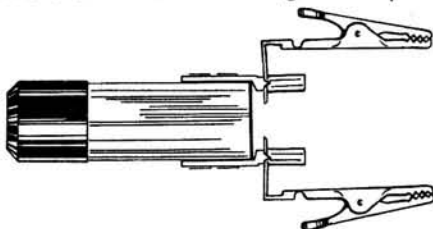

Fig. 2. Pin socket & clip attachments affixed to F coil

solder leads directly to the pins of the F coil, as the heat would melt the plastic coil form. See Fig. 2. If the unknown capacity is less than 50uuf, its value can be determined by paralleling an additional fixed known capacity of about 100uuf across the unknown capacity. Subtract this fixed known capacity from the value corresponding to the resonant frequency shown in the graph of Fig. 3 to find the unknown capacity. If the precise value of the fixed capacity to be added is not known, it can be found by the method described above. Note that a slight error may be encountered in measuring capacitance values due to the distributed capacitance of the coils, shift in resonance due to self-inductance of large capacitors, and capacitance due to nearby metallic objects. The error is usually negligibly small.

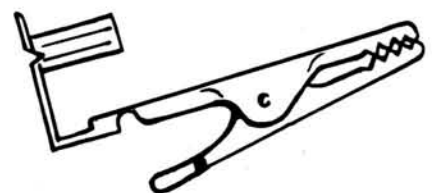
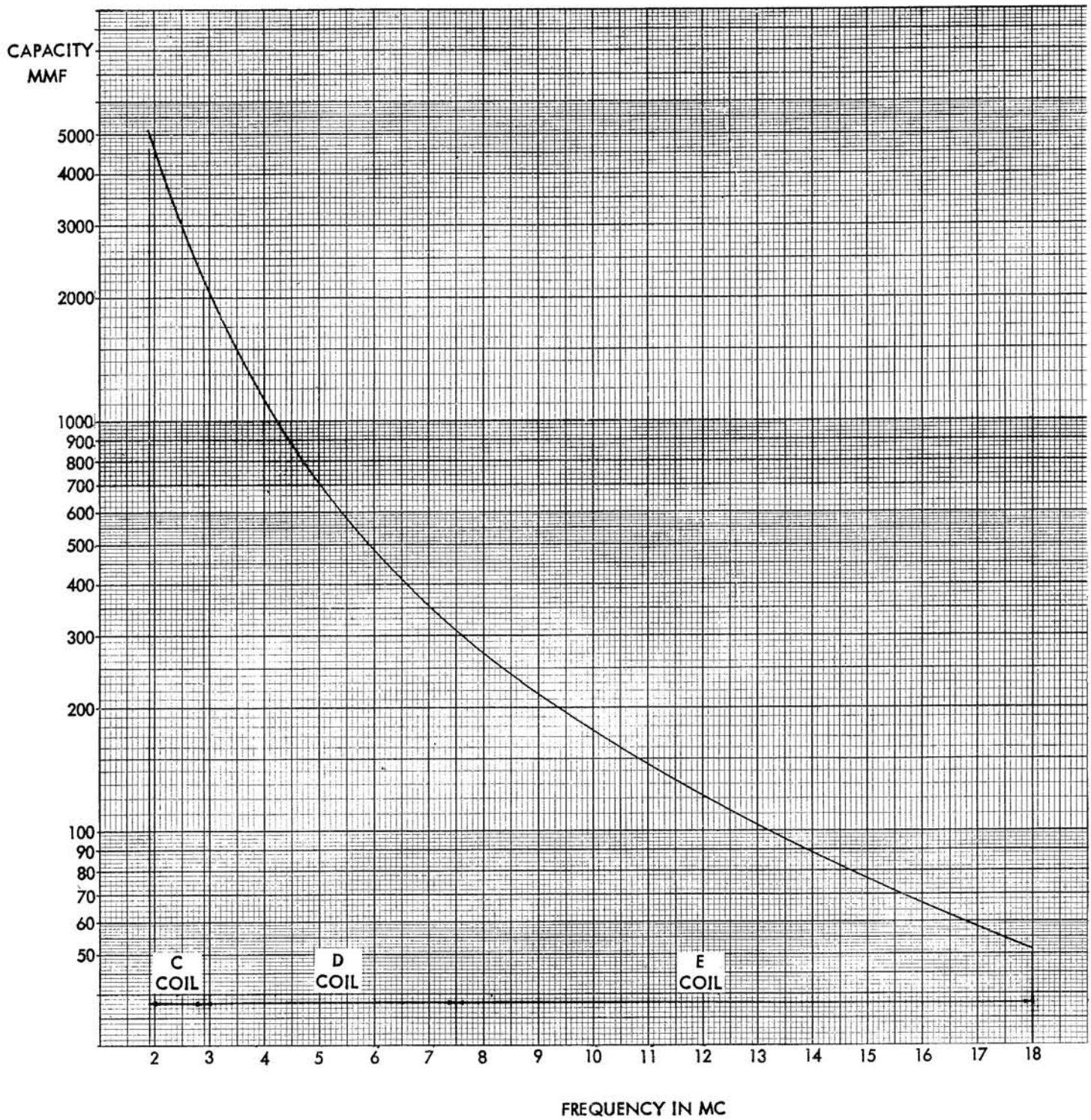

Fig. 2. Pin socket & clip detail



DETERMINE COIL (C, D, OR E) TO BE PLUGGED INTO 710 FROM ESTIMATED VALUE OF UNKNOWN CAPACITY. CAPACITY RANGE COVERED BY EACH COIL SHOWN ON FREQUENCY AXIS

BAND F COIL IN PARALLEL WITH UNKNOWN CAPACITOR IN ALL MEASUREMENTS

FIG. 3 CAPACITANCE MEASUREMENT

MEASURING INDUCTANCE

To measure the inductance of a coil, connect a low tolerance capacitor (silver mica) across it of about 100 uuf. Using the 710 as a g. d. o., couple the probe coil to the unknown coil and determine the resonant frequency. The unknown coil inductance L can be found from the relationship given below. In this formula, the resonant frequency measured is "f" (in cps) and the known fixed capacity "C" (in farads). The value found for L will be in henries.

$$L = \frac{1}{39.48f^2C}$$

MEASURING CIRCUIT Q

To measure the Q of a resonant circuit, use the 710 as a signal generator. Connect a VTVM with an RF probe across the circuit in question. Couple the probe coil to the coil in the resonant circuit and find the resonant frequency, which should correspond to a maximum or peak voltage reading on the VTVM. Note the resonant frequency. Then shift the 710 frequency on both sides of resonance to points where the VTVM voltage reading is about 70.7% (3 db down) of the maximum voltage reading noted at resonance. Note the frequencies at which these voltage readings occur, and then subtract the lower frequency value from the higher frequency value to determine the difference frequency. The value of Q can be found from the following relationship, where fr is the resonant frequency and f1-f2 the difference between the frequencies where the response is 3 db down.

$$Q = \frac{f_r}{f_1 - f_2}$$

RECEIVER TUNED CIRCUITS

Use instrument as g. d. o. With receiver power off adjust each tuned circuit to the desired frequency. Gang-tuned circuits should be checked at both ends of the range and a few points in between. After completing these adjustments, apply power to the receiver and use the 710 as a signal generator to check the final alignment. This is done by attaching a very short antenna to the receiver input terminals and locating the 710 a few feet away from the receiver at some point where it is removed from nearby conductors, and where body movements can not affect the r-f signal from the instrument. Alternatively, the 710 can be located a few feet from the receiver at a convenient point along the receiver transmission line. Tune the receiver, with AVC on, to a frequency at which no signals are present. An "S" meter, a vtvm, or some sort of indicator must be connected to the receiver detector. If the receiver is a superheterodyne and it is not functioning it may be useful to check the operation of the local oscillator. Using the 710 as a t. r. f. diode, couple the probe coil to the receiver oscillator coil. A maximum up-scale reading should be obtained at the resonant frequency of oscillator tank circuit if it is functioning.

PRE-SETTING TRANSMITTER TUNED CIRCUITS

Use instrument as g. d. o. Remove plate power from transmitter but leave all tube in the sockets and all circuits completed. Proceed to adjust tank circuits to desired frequency, after which plate power may be applied and final adjustments of alignment made with grid and plate meter indications. Using the 710 as a t. r. f. diode, each tank may be checked for correct frequency. The 710 may also be used as an oscillating detector for this work, but the increased sensitivity makes it necessary to avoid mistaking beats with other energized r-f circuits. Beating with the desired tank circuit may be checked by moving the probe coil nearer to it; increased volume of the audible beat indicates that the desired circuit is being checked. Also, beating against harmonics may occur. The lowest frequency beat heard is the fundamental.

NEUTRALIZATION

Use instrument as t. r. f. diode. Remove plate power from the stage to be neutralized (filament power should remain applied) and apply power to the driving stage. Couple the 710 "probe" coil to the output tank of the stage being neutralized. Set the instrument to the driving frequency and check for the presence of r. f. in the output tank circuit as evidenced by some meter reading other than zero. If r. f. is present, adjust the neutralizing capacitor until the meter reading goes to zero.

Another method, which can be used to check neutralization, requires operation of the 710 as a g. d. o. Again, plate power is removed from the transmitter but filament power remains applied. The 710 is then coupled to the grid tank of the stage to be neutralized with the meter set to the bottom of the dip. The instrument meter reading should remain unaffected as the plate tank capacitor is varied if neutralization has been achieved.

PARASITIC OSCILLATIONS

Use instrument as oscillating detector. With power applied to the transmitter, listen on headphone while varying the operating frequency of the 710 for a beat indicating the presence of a parasitic oscillation. If a parasitic is found, read its frequency from the 710 scale. Remove power from the transmitter and use the instrument as a g. d. o. to find the circuit or component resonant at the parasitic frequency.

ANTENNA ADJUSTMENTS

The 710 used as a g. d. o. aids in the adjustment of antennas without causing interference. However, there are many different types of antennas, feeders, and couplings that can be used and each situation has its specific adjustment requirements. When a particular antenna set-up is chosen to meet the needs of a given situation, an understanding of how the antenna operates will permit intelligent use of the 710 to aid in making adjustments properly. The antenna should always be near its final height and position if the resonance readings are to have real value.

GENERAL INSTRUCTIONS

The section of the manual beginning with this page is the CONSTRUCTION section. All pages in this section have page numbers followed by "C" (1C, 2C, etc.). The instruction section resumes on the pages following the CONSTRUCTION section. Note that the CONSTRUCTION section is located centrally in the manual and may be removed if desired.

We always urge care in the construction of a kit. In this case, it is doubly important because miniaturization techniques are employed in order to meet the size requirement and practically every bit of space inside the instrument is used. As a result, clearance between parts are small, and the sequence of assembly steps and the accompanying adjustment instructions must be followed to the letter if access and mechanical interference problems are to be avoided. For these reasons and electrical operation reasons as well, component placement and lead dress must also be exactly as instructed and shown in the drawings. Regardless of how experienced you are and how many kits you have built before, you can not afford to ignore the order of the construction steps, or any bit of information in an instruction step or in the carefully prepared drawings.

The construction techniques and the tools required given below are very important to the proper and easy building of this particular kit. Actual experience is behind every statement and the kit builder will be well rewarded by satisfaction with the completed instrument if heed is given now to the right way of going about the job. This is particularly true if your previous experience has been only with unminiaturized equipment and have become accustomed to construction techniques not as demanding as those suitable for building miniaturized equipment. To build miniaturized equipment successfully requires more patience and care, normal dexterity, and the proper tools for the job.

UNPACKING THE KIT: Unpack the kit carefully and check each part against the parts list including those parts that are mounted to the chassis. If you have trouble identifying any parts refer to the pictorial diagrams of the color code chart. The color code of each component is printed each time the component is referred to in the book.

You will find that the value of a component will vary within the allowable circuit tolerance. For example, the 4.7K Ω , $\pm 10\%$ resistor may measure anywhere between 4.2K Ω and 5.2K Ω . Tolerances on paper capacitors are substantially greater, and the tolerance for electrolytics is usually $\pm 100\%$ and -50% .

ESSENTIAL CONSTRUCTION TECHNIQUES: USE THE BEST GRADE OF ROSIN CORE SOLDER ONLY, preferably one containing the new activated fluxes such as Kester "Resin-Five", Ersin "Multicore" or similar types. UNDER NO CIRCUMSTANCES USE ACID CORE SOLDER OR ACID FLUX since acid flux can cause serious corrosion. Before soldering make certain of a good mechanical connection. Use a clean, freshly tinned soldering iron, or gun, and place the solder on the joint (not on the iron) so that the solder is melted by the heat from the joint itself. Do not remove the soldering iron until the solder flows and check to see that the resulting joint is smooth and shiny when the solder has cooled. There are two extremes to be avoided; too little heat and too much heat. If too little heat is supplied, the joint will appear pitted and grey, indicating a rosin joint which is unsatisfactory. On the other hand, if too much heat is applied to a joint, the parts connected to it may either change value, lose their protective coating, or break down. If you are soldering close to a part, hold the lead between the part and the joint being soldered with the tip of a pair of longnose pliers. The pliers will conduct the heat away and prevent the component from being unduly overheated. If for any reason it is necessary to resolder a joint, be sure to use new solder.

It should also be noted that the leads on resistors, capacitors, and transformers are often longer than required. These leads should be trimmed to the proper lengths. The recommended lengths, as well as the required lengths of all wires, are indicated in the wiring steps.

Another procedure adopted in the Model 710 is to mount some parts to the main chassis temporarily (e.g. slide switches) in order to make wiring easier. These parts are subsequently loosened and then re-tightened together with another part which is held in place by the mounting. The top panel and the gear drum assembly are mounted in this manner. Specific instructions will always be given which cover every step required. Finally, it should be mentioned that certain parts like the plexiglass scale window and the dial drum itself are delicate and can be scratched easily. Handle these parts with care.

BASIC TOOLS REQUIRED: These basic tools are required for the proper construction of the kit.

1. A 50-60 watt soldering iron with a long thin soldering tip (at least 1 1/2" long and no more than 1/4" diameter). A soldering gun of no more than 100 watts is also very good for the job.
2. A sturdy tweezers.
3. Screwdrivers of 3/32" and 1/8" blade widths are required. The 3/32" blade is used to tighten the set screws on the large gear and the drive knob

of the dial drum assembly. The 1/8" blade is used for general assembly work.

4. Longnose pliers — 5 or 6".
 5. Diagonal cutters.
 6. High quality rosin or equivalent synthetic flux core solder. Do not use acid or paste flux under any circumstances.
- A set of spinrites and a wire stripper are also very useful supplementary tools.

PARTS IDENTIFICATION: Please note that many of the resistors and capacitors for which color coding is given, may not be color coded, but have their values and ratings printed. To aid in rapid identification 10% and 20% resistors are almost always color coded, while all 1%, 5% resistors and all capacitors usually have their values printed. Printed numbers may appear with the letter "K", indicating that the number is to be multiplied by 1000. The letter "M" indicates a multiplication by 1,000,000. "mf" indicates microfarads or 1/1,000,000 farad. "mmf" indicates microfarads or 1/1,000,000 of a microfarad. The alternate way of writing capacitor values are indicated in the construction book when the component is used. Please note the

following examples of relationship between units.

- 1,000,000 micro-microfarads (mmf) = 1 microfarad (mf)
- 10,000 mmf = 10K mmf = .01 mf
- 1,000,000 ohms (Ω) = 1000 kilohms = 1 megohm ($M\Omega$)
- 2,700,000 Ω = 2,700K Ω = 2.7M Ω
- 470,000 Ω = 470K Ω = 0.47M Ω
- 2,700 Ω = 2.7K Ω

CONSTRUCTION PROCEDURE: The complete step-by-step mounting and wiring procedure follows. To keep the drawings uncrowded, unnecessary repetition of mounting or wiring details may be omitted. Note: The abbreviation (C) means connect but do not solder (until other leads have been connected). The abbreviation (S) means connect and solder. The number after "(S)" indicates the number of connections to be soldered to the terminal. You can also check if you have made the proper number of connections to the terminal.

SOCKET PREPARATION

One seven pin miniature tube socket is supplied with your Model 710 grid dip meter. To assure proper operation of the instrument, this socket must be prepared for wiring, as shown in the figure.

- () 1. Fig. 1. On the metal saddle, you will find four lugs which can be used for grounding purposes. In the bakelite portion, you will find seven pins, each numbered in clockwise sequence. Place the socket on table, with the seven pins up towards you. Look straight down on the socket. Each ground lug, although physically closer to the table than the tube pins, is located between two of the pins. Thus one ground lug is between pins 2 and 3, a second ground lug is between pins 4 and 5, etc. Bend the ground lug that is located between pins 2 and 3, so that it is facing straight out, parallel to the table. The three other ground lugs are bent down against the metal socket saddle, so that they are pointing towards the table.

- () 2. Fig. 1. Position the socket as in step 1, flat against the table, with the seven pins pointing upwards, towards you. Bend the seven pins back, away from the center of the socket, so that they are all parallel to the table, and are against the bakelite portion of the socket. When this operation is completed, the pin numbers are clearly visible. Note that they are not to be bent down towards the table or short against the saddle.

- () 3. Fig. 1. Cut the lugs #1, #2, #6 and #7 to $3/16"$. This is to be measured from the point of emergence of the pin from the bakelite. Keep the above pin lengths to the $3/16"$, or they will short against the panel and chassis after they have been wired. Do not cut lugs #3, #4 and #5.

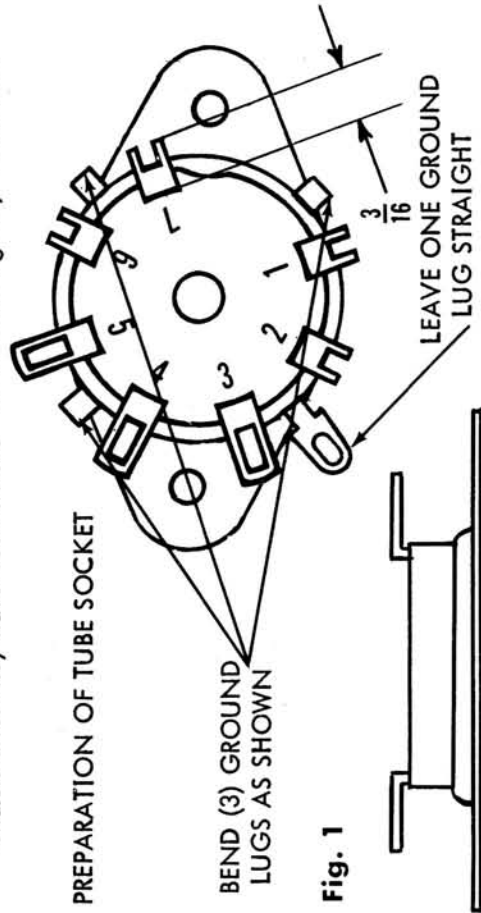

Fig. 1

CHASSIS ASSEMBLY

The completed EICO Model 710 grid dip meter consists of four major metal components: 1. Panel, 2. case, 3. main chassis and 4. "U" shaped bracket. These parts are easily differentiated from each other. The complete chassis assembly consists of components 3 and 4 -- the main chassis and the "U" shaped bracket, respectively. The following steps will involve these two metal pieces and the electrical components mounted to them.

Note that the complete assembly of your grid dip meter is shown in figure 2. Letters "L", "V", "W", "X", "Y" and "Z" have been assigned to the components comprising the drum gear assembly. This item will be furnished to you preassembled by EICO. Only the main chassis and "U" bracket assembly will be completed on this page.

- () 1. Fig. 2. On the flat back surface of the chassis, you will find very small holes, approximately $1/16"$ diameter, spotted along the center line. These are intended to receive the self-tapping PK screws which fasten the chassis to the cabinet. However, these small holes must be tapped in order to receive the PK screws easily. Do this by laying the chassis down, overhanging the edge of the work table, so that the flat back surface is parallel to the work table surface. Drive one of the self-tapping PK screws all the way into each of the holes, in order to get a full top (drive by applying pressure to the screw while turning clockwise with a screwdriver). When you are through, place the PK screw back with the rest of the kit hardware.

- () 2. Fig. 2. Mount the seven pin miniature tube socket XV1 prepared above, as shown. Use two #4-40 x $1/4$ screws, two #4 lockwashers and two #4-40 x $1/4$ hex nuts.

- () 3. Fig. 2. Mount the four post terminal strip, TB1, and the two post right with ground terminal strip, TB2, as shown. Use one #4-40 x $1/4$ screw, one #4 lockwasher and one #4-40 x $1/4$ hex nut on each. Bend the ground lug on TB2 so that it is parallel to the large flat surface of the chassis, pointing towards the tube socket, XV1.

- () 4. Fig. 2. The coil receptacle jack consists of two pieces of bakelite riveted together at the center. Three solder lugs surround this center rivet. At the two extremes, are two mounting holes. Mount this jack, J2, as shown. Note the direction of orientation of the solder lugs. Use two #6-32 flat head screws and two #6-32 hex nuts.

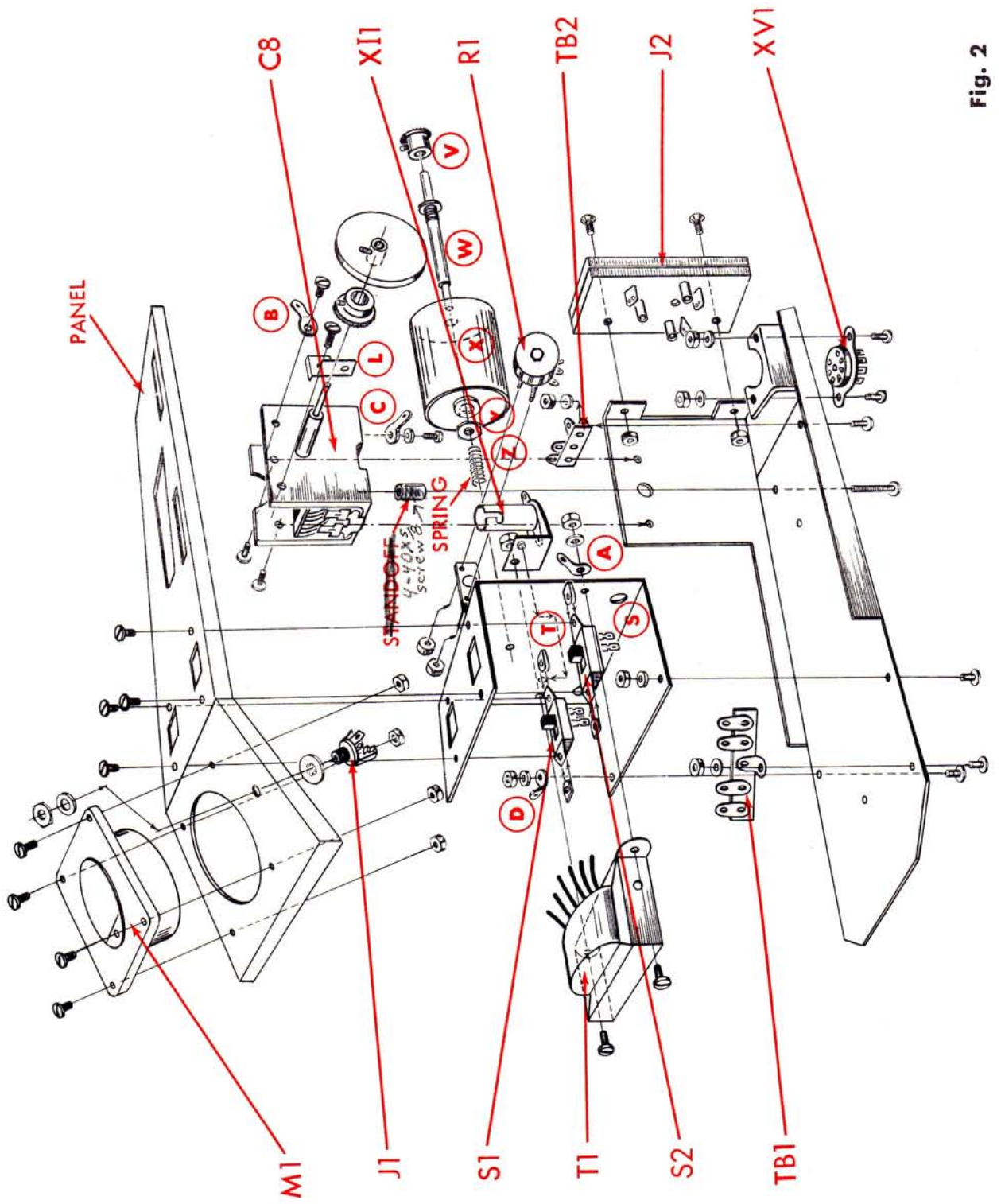

Fig. 2

screws, two #4 lockwashers and two #4-40 x 1/4 hex nuts. Next to one of the transformer mounting holes, you will find a second hole. Under the nut holding the screw going through this transformer mounting hole, mount the pilot light socket, X11. The indentation from the pilot light socket goes through the adjacent second hole just discussed. Under the nut holding the remaining screw used for mounting the transformer, mount #4 ground lug "A".

() 5. Fig. 2. Turn the plates on the variable capacitor so that they are fully meshed to prevent damage. From below the chassis (large flat surface), push a #4-40 x 5/8 screw through the appropriate hole to mount the variable capacitor, C8, as shown. ~~From above the chassis, place a screw over the screws.~~ Holding the capacitor as shown, turn the screw into the threaded hole in the bottom frame of the capacitor. Do not tighten this screw yet.

Rest the capacitor on the variable capacitor support bracket

() 10. Fig. 2. Four small triangular Tinnerman nuts are supplied with the kit. These small nuts have two wings, held together by the spring action of the metal. Mount these four nuts on the two slide switch mounting brackets. The Tinnerman nut holes are to coincide with the switch mounting holes. The flat side of the Tinnerman nut must be facing up, so that when looking straight down at the switch, you can see the flat side of the Tinnerman nuts, as well as the switch slider.

() 6. Fig. 2. Two of the solder lugs on the variable capacitor C8, are near lugs #1 and #2 on the coil receptacle jack J2. The capacitor lugs should touch these receptacle lugs. If they do not, bend the capacitor lugs towards the receptacle lugs until they do touch. On the opposite side of the capacitor, you will find two similar lugs. Cut these off.

() 11. Fig. 2. Place the miniature potentiometer, R1, flat on a table, so that the lugs are facing up towards you. Bend the lugs so that they are parallel to the table, away from the center of the potentiometer, and are against the body of the component. Use two #1-64 hex nuts, (the two smallest nuts in this kit) to mount the pot to the small "L" shaped bracket which has been welded to the "U" bracket. Align the center pin on the pot so that it is concentric with the hole in the "L" bracket. Tighten the nuts. Note the position of the lugs in fig. 5.

() 7. Fig. 2. Mount a #6 solder lug "B" to the side of the variable capacitor frame, C8, as shown. Use one #4-40 x 1/8 screw. Orient this lug and bend it so that it touches lug #3 on coil receptacle jack J2.

() 12. Fig. 2. Mount the "U" shaped bracket to the main chassis, in such a direction that the pilot light socket is next to the variable capacitor, as shown. Use two #4-40 x 1/4 screws, two #4 lockwashers and two #4-40 x 1/4 hex nuts. Under one of the lockwashers, mount the #4 ground lug "D". Do not tighten these screws yet.

() 8. Fig. 2. Mount a #4 solder lug "C" to the bottom of the variable capacitor frame, C8, as shown in figure 3. Use one #4-40 x 1/4 screw and one #4 lockwasher. Orient this lug and bend it so that it touches the nearest ground lug on the socket, XV1.

() 9. Fig. 2. On power transformer, T1, cut one green lead to 3 1/2" and the second green lead to 2 3/4". Cut one red lead to 1 1/4" and the second red lead to 2 5/8". Cut one black lead to 1" and the second black lead to 4 1/4". Strip off 1/4" of the insulation from the end of each lead.

Mount the power transformer to the "U" shaped bracket of the chassis assembly, as shown. The transformer is mounted so that the leads are toward the wing with the two rectangular slits. Use two #4-40 x 1/4

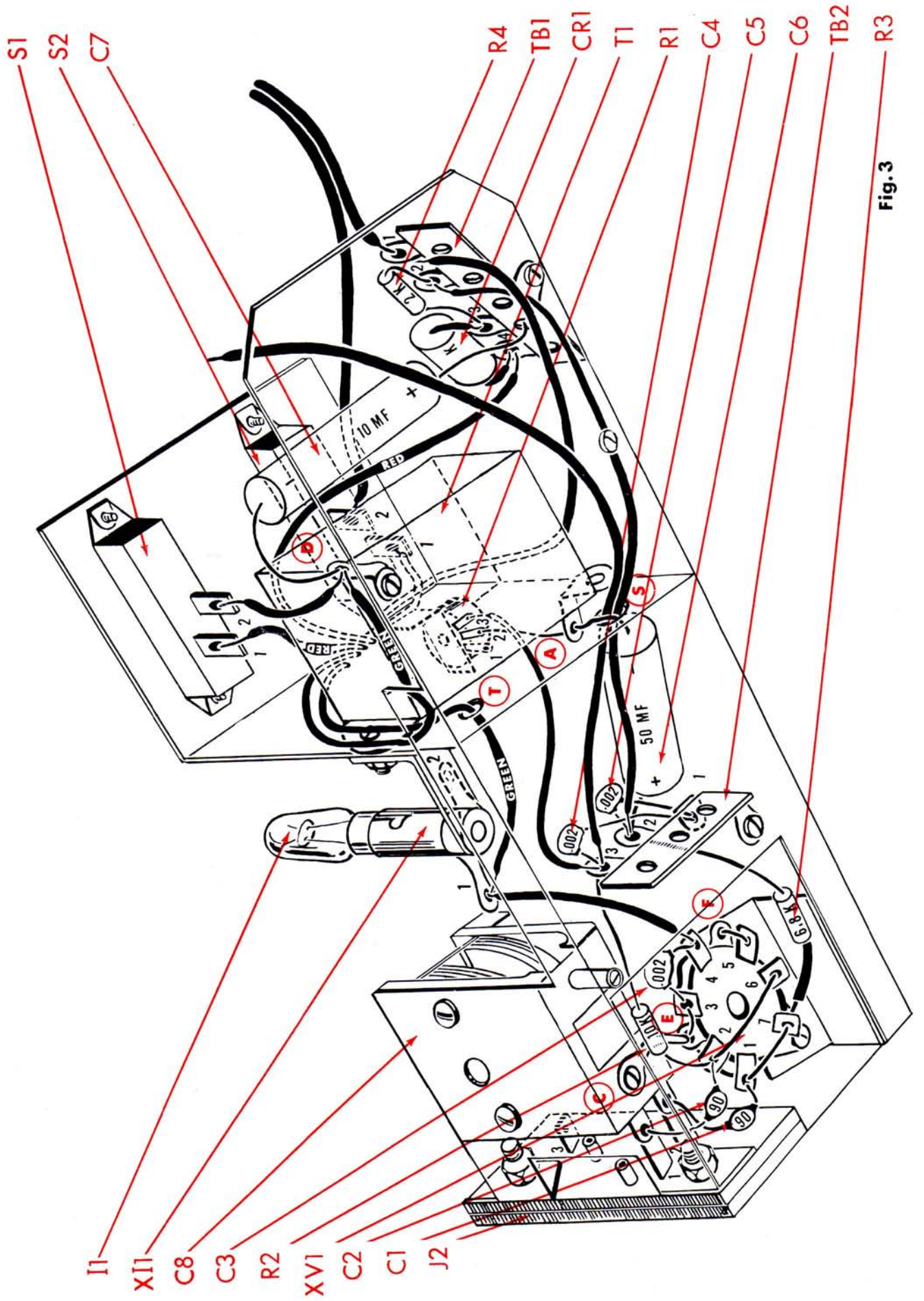

Fig. 3



WIRING

Figure 3 is a view of the wiring from below the chassis. Imagine that the chassis is transparent, and that you are looking through the main chassis.

- () 1. Fig. 3. From power transformer T1, push the longer green lead through hole "T" in the "U" bracket and connect it to X11-1 (C). Connect the shorter green lead to ground lug "D" (C). Connect the shorter red lead to S1-1 (S1) and the longer red lead to TB1-4 (C). Connect the shorter black lead to S2-1 (S1) and the longer black lead to TB1-1 (C). See figures 4 and 5.
- () 2. Fig. 3. Connect a 1 1/2" piece of black wire from S1-2 (S1) to ground lug "D" (C).
- () 3. Fig. 3. Connect one end of 5 1/2" of red wire to TB1-2 (C). Push the other end of the wire through hole "S" in the "U" bracket. Connect this end to TB2-2 (C).
- () 4. Fig. 3. On the 10 mfd, 150 volt electrolytic capacitor, C7, cut both leads to 1/2". Connect the positive (+) lead to the lower hole, nearest the chassis, in TB1-3 (C) and the negative (-) lead to ground lug "D" (S3). See figure 4. Dress the capacitor close to the power transformer and to the main chassis.
- () 5. Fig. 3. Cut both leads on the 2K (red, black, red, silver) resistor, R4, to 1/2". Connect from TB1-2 (S2) to TB1-3 (C). See figure 5.
- () 6. Fig. 3. Cut both leads on the selenium rectifier, CR1, to 3/4". Connect the red cathode end to TB1-3 (S3) and the black anode end to TB1-4 (S2). See figure 5. (Make sure you solder the lead coming through the lower hole in TB1-3).
- () 7. Fig. 3. Solder lug #2 on the pilot light socket, X11, to the pilot light bracket. See figure 4.
- () 8. Fig. 3. Cut both leads on a 90 mmf disc capacitor, C1, to 1/2".
- Connect from J2-2 (S2) to XV1-1 (C). At J2-2, be sure to solder the lug from the variable capacitor as well as one lead from C1. Dress this capacitor against the insulating body of the coil receptacle jack, J2.
- () 9. Fig. 3. On the 90 mmf disc capacitor, C2, cut one lead to 3/4" and the second lead to 1/2". Connect the longer lead to J2-1 (S2) and the shorter lead to XV1-2 (C). Solder the variable capacitor as well as one lead from C1 to J2-1. Keep this capacitor away from C1. (Step 8 above).
- () 10. Fig. 3. Connect a 3/4" piece of bare wire from XV1-1 (S2) to XV1-7 (C). Keep wire straight. Cut off any excess wire.
- () 11. Fig. 3. Connect a 1" piece of bare wire from XV1-2 (C) to XV1-6 (S1). Keep wire straight. Cut off any excess wire.
- () 12. Fig. 3. Connect a 1/2" piece of bare wire from XV1-3 (C) to ground lug "E" (C), on XV1.
- () 13. Fig. 3. Solder the ground lug "C" to the ground lug "E" on XV1 as well as the lead connected to ground lug "E" in step 12, above.
- () 14. Fig. 3. Connect a 1/2" piece of bare wire from XV1-5 (S1) to ground lug "F" (S1) at XV1.
- () 15. Fig. 3. Cut both leads on a .0022mfd (2.2K or 2200mmf) disc capacitor, C3, to 1/2". Connect from XV1-3 (S2) to XV1-4 (C).
- () 16. Fig. 3. Cut both leads on a 10K (brown, black, orange, silver) resistor, R2, to 3/4". Connect from XV1-2 (S3) to TB2-3 (C).
- () 17. Fig. 3. Cut one lead on a 6.8K (blue, grey, red, silver) resistor, R3, to 3/4" and the second lead to 1/2". Cover the longer lead with a 1/2" piece of spaghetti, and connect to XV1-7 (S2). Connect the shorter lead to TB2-2 (C).
- () 18. Fig. 3. Connect a 2" piece of green wire from XV1-4 (S2) to X11-1 (S2). See figure 4.

() 5. Fig. 2. Turn the plates on the variable capacitor so that they are fully meshed to prevent damage. From below the chassis (large flat surface), push a #4-40 x 5/8 screw through the appropriate hole to mount the variable capacitor, C8, as shown. ~~From above the chassis, place a screw over the screw.~~ Holding the capacitor as shown, turn the screw into the threaded hole in the bottom frame of the capacitor. Do not tighten this screw yet.

Rest the capacitor on the variable capacitor bracket

() 10. Fig. 2. Four small triangular Tinnerman nuts are supplied with the kit. These small nuts have two wings, held together by the spring action of the metal. Mount these four nuts on the two slide switch mounting brackets. The Tinnerman nut holes are to coincide with the switch mounting holes. The flat side of the Tinnerman nut must be facing up, so that when looking straight down at the switch, you can see the flat side of the Tinnerman nuts, as well as the switch slider.

() 6. Fig. 2. Two of the solder lugs on the variable capacitor C8, are near lugs #1 and #2 on the coil receptacle jack J2. The capacitor lugs should touch these receptacle lugs. If they do not, bend the capacitor lugs towards the receptacle lugs until they do touch. On the opposite side of the capacitor, you will find two similar lugs. Cut these off.

() 7. Fig. 2. Mount a #6 solder lug "B" to the side of the variable capacitor frame, C8, as shown. Use one #4-40 x 1/8 screw. Orient this lug and bend it so that it touches lug #3 on coil receptacle jack J2.

() 8. Fig. 2. Mount a #4 solder lug "C" to the bottom of the variable capacitor frame, C8, as shown in figure 3. Use one #4-40 x 1/4 screw and one #4 lockwasher. Orient this lug and bend it so that it touches the nearest ground lug on the socket, XV1.

() 9. Fig. 2. On power transformer, T1, cut one green lead to 3 1/2" and the second green lead to 2 3/4". Cut one red lead to 1 1/4" and the second red lead to 2 5/8". Cut one black lead to 1" and the second black lead to 4 1/4". Strip off 1/4" of the insulation from the end of each lead.

Mount the power transformer to the "U" shaped bracket of the chassis assembly, as shown. The transformer is mounted so that the leads are toward the wing with the two rectangular slits. Use two #4-40 x 1/4

() 11. Fig. 2. Place the miniature potentiometer, R1, flat on a table, so that the lugs are facing up towards you. Bend the lugs so that they are parallel to the table, away from the center of the potentiometer, and are against the body of the component. Use two #1-64 hex nuts, (the two smallest nuts in this kit) to mount the pot to the small "L" shaped bracket which has been welded to the "U" bracket. Align the center pin on the pot so that it is concentric with the hole in the "L" bracket. Tighten the nuts. Note the position of the lugs in fig. 5.

() 12. Fig. 2. Mount the "U" shaped bracket to the main chassis, in such a direction that the pilot light socket is next to the variable capacitor, as shown. Use two #4-40 x 1/4 screws, two #4 lockwashers and two #4-40 x 1/4 hex nuts. Under one of the lockwashers, mount the #4 ground lug "D". Do not tighten these screws yet.

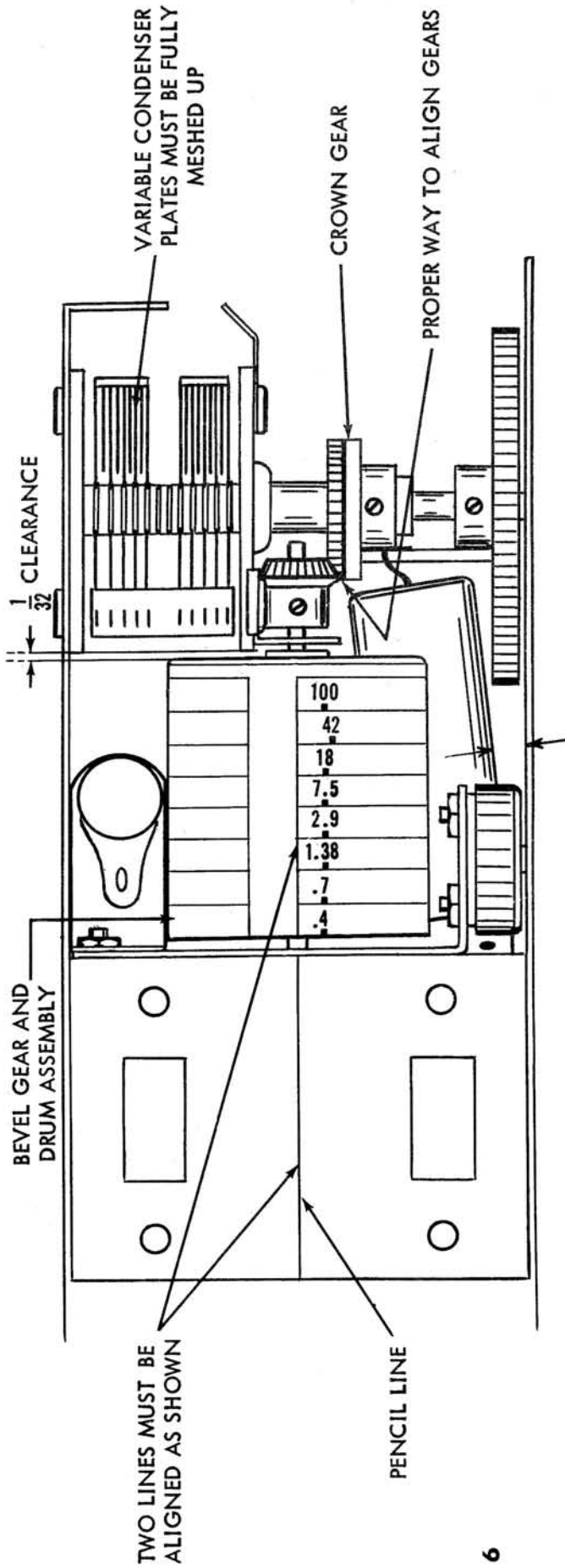

Fig. 6

DRUM AND GEAR ASSEMBLY

In the following steps, $1/16$ " and $1/32$ " measurements can be made with gauges similar to that used for adjusting automobile spark plugs, or with a ruler.

- () 1. Fig. 6. $1/8$ " from either edge of the top of the "U" shaped bracket, draw a line perpendicular to the variable capacitor. This is at the center of the bracket.
- () 2. Fig. 6. Loosen completely the two screws holding the "U" bracket to the main chassis. The nuts should be held onto the screw with several threads.
- () 3. Fig. 6. Push a spring over the thinner portion of the center axle inside the drum assembly. Do not force the spring over the thicker portion of the axle.
- () 4. Fig. 6. With the left hand, push the "U" shaped bracket toward the 4 post terminal strip TB1, mounted on the main chassis. With the right hand, push the axle with the spring on the drum assembly, through the hole "R" in the "U" shaped bracket. See fig. 5 for location of the hole. The spring tends to push the drum assembly towards the variable capacitor.

With a #4-40 x $1/8$ screw fasten the bracket "L" on the drum assembly to the frame of the variable capacitor. Center the "U" shaped bracket on the main chassis and tighten the screws holding this bracket to the chassis. When properly assembled, the drum has $1/16$ " axial play, and rotates freely.

- () 5. Fig. 6. The capacitor plates must be fully meshed (maximum capacity). Push the drum towards the "U" shaped bracket so that the clearance between the frame of the capacitor and the body of the drum is $1/32$ ". See fig. 6. Turn the drum so that the beginning of the scale, nearest the .4 mc marking, coincides with the line drawn in step 1, above.

Slip a crown gear over the $1/4$ " shaft on the variable capacitor. Engage this with the small conical gear, "V", on the drum assembly. Tighten the set screw on the crown gear. Note that the pressure of the conical gear (on the drum) on the crown gear is the force necessary to keep the drum $1/32$ " from the frame of the variable capacitor. When properly assembled, results will appear as shown in figure 6. Drum will rotate freely with $1/32$ " axial play compensated by the spring. This is an example of a spring loaded, right angle gear drive which takes out the backlash.

- () 6. Fig. 6. Slip the black tuning knob over the $1/8$ " shaft on the variable capacitor. Do not tighten the set screw as yet.

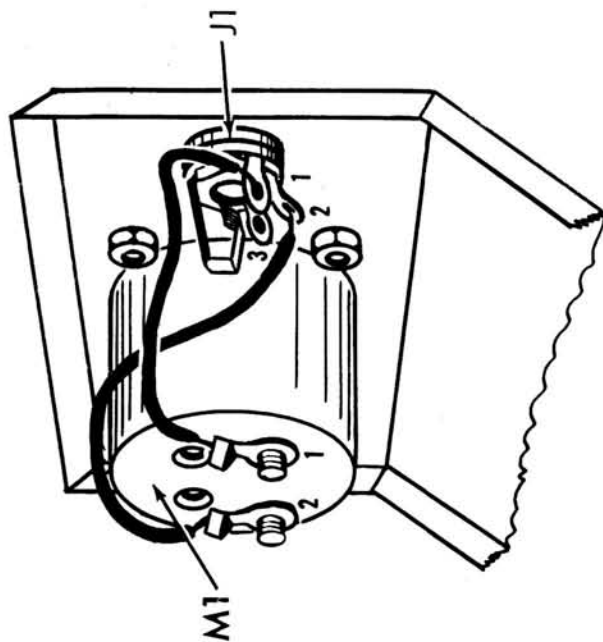

Fig. 7

PANEL ASSEMBLY AND WIRING

- () 4. Fig. 7. Connect a 3 1/4" piece of black wire from J1-2 (S1) to M1-2 (S1). Dress the wire close to the meter body and panel, as shown.
- () 5. Fig. 7. Push the pilot light into the pilot light socket, X11. Place a shield over the pilot light bulb.
- () 6. Fig. 7. Push the 6AF4A tube, V1, into the socket, XV1. The tube is positioned at a slight angle with the chassis, when it fits snugly in its socket.
- () 7. Fig. 7. Unscrew the four screws holding the slide switches, S1 and S2. The panel is mounted to the "U" shaped bracket with these four screws. Slide the black tuning knob, previously mounted on the shaft of the capacitor, so that it fits through the slit marked tuning on the panel. Align the panel so that the inscribed line on the plastic plate, which appears in the center of the trapezoidal cutout, is directly over and parallel to the line used in step 5 referring to figure 6. Tighten the panel to the "U" shaped bracket and the slide switches, using the #4-40 screws just removed from the switches. All controls and both switches should move freely without rubbing or sticking.
- () 8. Fig. 7. Center the black tuning knob in the slit and tighten the screw from the front side of the unit, next to the tube.
- () 9. Fig. 7. Turn tuning knob. Note that it should rotate freely. If it does not, check point of friction. If it hits the side of the tube, bend the tube bracket slightly with a pair of long nose pliers. If it rubs against the electrolytic capacitor, push the capacitor out of the way, so that there is a 1/32" clearance.
- () 10. Fig. 7. Solder the black wire from hole "5" to J1-3 (S1).
- () 11. Fig. 7. Push a 5/16" rubber grommet through the hole in the short side of the cabinet.
- () 12. Fig. 7. Push the end of the line cord with the tinned leads from the outside of the cabinet, through the grommet. Solder one tinned lead to S2-2 (S1) and the second tinned lead to TB1-1 (S2). See Fig. 3.

- () 1. Fig. 7. Mount phone jack J1 as shown in figure 2. Use the lock-washer, flatwasher and hex nut supplied with the jack to secure it to the panel.
- () 2. Fig. 7. If the meter you have has four mounting studs screws already mounted on the meter movement, push the meter through the holes and mount it with the four #4-40 x 3/16 hex nut. If your meter is of the type that does not have the four screws already mounted to its frame, push 4-40 x 5/16 screws through the four holes on the front of the meter. Secure the meter to the panel using four #4-40 x 3/16 hex nuts. Orient as shown. Note the front panel so that meter is mounted properly up and down.
- () 3. Fig. 7. Connect a 2 1/2" piece of red wire from J1-1 (S1) to M1-1 (S1). Dress the wire close to the meter body and panel, as shown.

TEST AND FINAL ASSEMBLY

You have now completed the wiring and assembly of your Model 710 grid dip meter. Make the following checks to ascertain that your meter is working properly before putting the unit into its cabinet.

- () 1. Put slide switch S1 into the "DIODE" position and slide switch S2 into the OFF position. Plug unit into a 110, 120 volt, 60 cycle AC line. Slide S2 to the ON position. Scale should be illuminated by bulb I1, immediately. If it fails to light, check the filament and transformer primary wiring.
- () 2. Plug in coil marked .4 to .7 mc. Turn sensitivity control to maximum counter clockwise position. Put slide switch S1 into "OSCILLATOR" position. Measure voltage at TB1-2. Meter should read between 90 and 120 volts DC.
- () 3. With coil plugged in as in 2, turn the sensitivity control to a suitable clockwise position, so that you get a reading at mid-scale on the meter movement. Lack of deflection indicates that instrument is not oscillating. Check wiring, soldering, and tube if oscillation is not detected.
- () 4. Check all the coils by plugging each one into the coil socket. With each coil, turn the tuning control through the complete frequency range. It is normal for the meter reading to vary with the setting of the tuning control. At any frequency with any coil, it should be possible to find a setting of the sensitivity control that results in a mid-scale reading.
- () 5. Put instrument into its cabinet, pulling line cord through the hole to

the outside of the cabinet. Line up the screw holes in the bottom of the cabinet with the screw holes in the bottom of the chassis. Note that the apron on the panel fits over the cabinet. Secure the chassis to the cabinet using #4 self-tapping PK screws.

SERVICE

If you are still having difficulty, write to our service department listing all possible indications that might be helpful. If desired, you may return the instrument to our factory where it will be placed in operating condition for \$5.00 plus the cost of parts replaced due to their being damaged in the course of construction. This service policy applies only to completed instruments constructed in accordance with the instructions as stated in the manual. Instruments that are not completed or instruments that are modified will not be accepted for repair. Instruments that show evidence of acid core solder or paste fluxes will be returned not repaired. NOTE: Before returning this unit, be sure all parts are securely mounted. Attach a tag to the instrument, giving your home address and the trouble with the unit. Pack very carefully in a rugged container, using sufficient packing material (cotton, shredded newspaper, or excelsior), to make the unit completely immovable within the container. The original shipping carton is satisfactory, providing the original inserts are used or sufficient packing material is inserted to keep the instrument immovable. Ship by prepaid Railway Express, if possible, to the Electronic Instrument Co., Inc., 33-00 Northern Blvd., L.I.C. 1, New York. Return shipment will be made by express collect. Note that the carrier cannot be held liable for damages in transit if packing, IN HIS OPINION, is insufficient.

EICO THE EICO WARRANTY **EICO**

The Electronic Instrument Company, Inc., hereafter referred to as EICO, warrants that, for a period of 90 days from the date of purchase, any EICO kit will be free of defects in parts, and that any EICO factory-wired unit will be free of defects in parts and workmanship. For an EICO kit, EICO's obligation is limited to those parts which are returned transportation prepaid to the factory or authorized service agency without further damage, and in the judgement of EICO are either originally defective or have become defective in normal use. EICO's obligation does not include any labor required to locate trouble in or repair a kit. For an EICO factory-wired unit, EICO's obligation is limited to replacement or repair, at EICO's option, of those parts, sections, or entire units returned transportation prepaid to the factory or authorized service agency without further damage, and in the judgement of EICO are either originally defective or have become defective in normal use.

The warranty does not apply to any parts damaged in the course of handling, assembling, or wiring by the customer, or damaged due to abnormal usage or in violation of instructions or reasonable practice, or further damaged to a consequential degree in return shipment. Furthermore, the foregoing warranty is made only to the original customer, and is and shall be in lieu of all other warranties, whether expressed or implied, and of all other obligations or liabilities on the part of EICO, and in no event shall EICO be liable for any anticipated profits, consequential damages, loss of time, or other losses incurred by the customer in connection with the purchase or operation of EICO products or components thereof.

The registration card, which accompanies each EICO kit or factory-wired unit, must be filled in and returned to the company within 10 days after the date of purchase. This warranty applies only to registered units.

SCHEDULE OF SERVICE CHARGES

1. Same prices for wired units or completed kits.
2. Charges are based on the schedule of minimum charges above. Some exceptions are noted below.
3. If the published rate is \$ 5.00-\$ 6.00, this covers up to 1 hour of labor time (minimum \$5.00).
If the published rate is \$ 6.50-\$ 8.00, this covers up to 1½ hours.
If the published rate is \$ 9.00-\$10.00, this covers up to 2 hours.
If the published rate is \$11.00-\$14.50, this covers up to 2½ hours.
If the published rate is \$15.00-\$20.00, this covers up to 3½ hours.
4. Time required in excess of these minimum charges is calculated at \$5.00 per hour.
5. Above prices are for labor only. Parts are additional.
6. Miscellaneous prices not published in manuals are:
Probes - \$2.00 RP-100 Playback amp. only or
CRA & CRU - \$3.00 Power Supply only
or Record amp. only ... \$5.00
2536 Printed Circuit Board - \$5.00.
7. **ESTIMATES:** An estimate for repairs will be given before repairs are made where repairs will exceed stated minimum charges. If you choose not to have your unit repaired, a charge of \$3.00 for estimating time will be made.
8. All prices are subject to change without notice.

MINIMUM LABOR AND HANDLING FEES

AF4	\$ 7.50	488	5.00
RA6	5.00	495	5.00
HF12	7.50	526	5.00
HF14	5.00	536	5.00
HF20	10.00	540	5.00
HF22	5.00	555	5.00
HF30	5.00	556	5.00
HF32	9.50	565	5.00
HF35	5.00	566	5.00
ST40	15.00	584	5.00
HF50	5.00	610	5.00
HF52	10.00	612	5.00
HF60	5.00	625	6.00
HF61	6.00	628	7.00
HF61A	6.00	630	5.00
HF65	6.50	632	7.00
HF65A	6.50	666	10.00
ST70	15.00	667	10.00
HF81	13.50	680	6.00
ST84	10.00	706	5.00
HF85	8.00	710	5.00
HF86	9.00	720	13.50
HF87	9.00	722	9.00
HF89	9.00	723	10.00
HFT90	7.50	730	10.00
HFT92	9.00	740	9.00
HFT94	7.50	753	25.00
ST96	13.50	760	9.00
ST97	13.50	761	9.00
MX99	7.50	762	9.00
RP100*	*	770	12.00
		771-2	12.00
145	5.00	777	20.00
145A	5.00	779	20.00
147	5.00	790	20.00
214	6.00	803	5.00
221	6.00	902	25.00
222	7.00	944	5.00
232	6.00	950	5.00
249	6.00	955	6.00
250	7.00	965	15.00
255	7.00	1020	5.00
260/261	7.00	1050	5.00
315	6.00	1055	5.00
320	5.00	1060	5.00
322	5.00	1064	6.00
324	5.00	1073	5.00
342	15.00	1078	5.00
352	5.00	1100	5.00
360	5.00	1120	5.00
368	12.50	1140	5.00
369	12.50	1171	5.00
377	6.00	1180	5.00
380	16.00	2036	13.50
425	6.00	2050	13.50
427	12.50	2080	13.50
430	12.50	2200	10.00
435	15.00	2400*	*
460	15.00	2510	12.00
470	15.00	2536	17.50
		2715/16	10.00
		3566	25.00
		4000	20.00

* Model RP100 and Model 2400 will be billed on the basis of \$10.00 for the first hour and \$5.00 each additional hour, with a maximum unauthorized repair of \$50.00 for the kit and \$25.00 for a wired unit.

In any case, the proper type of coupling should be used (inductive at current maximums, capacitive at voltage maximums) and this coupling should usually be loose. Coupling along the line or at the ends is possible with parallel feed lines, but a co-axial line can only be coupled to at the ends. Checking at the end of a line is usually done by inductive coupling to a shorting loop across the inner and outer conductors of the co-ax cable or across the ends of the parallel feeders.

Correct matching of open wire lines to an antenna can be checked by using the 710 as a t.r.f. diode to indicate the presence of standing waves. The instrument "probe" coil must be moved along the line with constant coupling maintained. All of the "probe" coils, except the hair-pin high-frequency coil, have insulating caps which permit this to be done without holding a piece of insulating material between the "probe" coil and the line. Considerable variation in readings indicates the presence of standing waves. When correct matching of the line is obtained,

standing waves will disappear. For the latter operation, power must be fed into the feed lines by the transmitter.

To determine correct matching of a co-axial line, use the instrument as a t.r.f. diode. Only in this case, place it near the antenna where it will serve as a field-strength meter. Correct matching is indicated by maximum strength indication, corresponding to maximum output from the antenna.

CHECKING QUARTZ CRYSTALS

Use the instrument as a g.d.o. Connect a short lead with an alligator clip at each end across the crystal holder pins. Insert the instrument "probe" coil into the loop made by the lead and tune for the grid-dip indication. The crystal frequency can then be read from the instrument's frequency scales. This check also indicates the activity of the crystal, since an inactive crystal will not produce the grid-dip indication.

maintenance

Included in this section are a VOLTAGE CHART, a RESISTANCE CHART, and a TROUBLE-SHOOTING CHART

listing common symptoms of trouble together with their possible causes.

VOLTAGE CHART

TERMINAL BOARD TB1	Lug 2	Lug 3
	125 DC	108 DC

TUBE SOCKET XV1	Pin 1	Pin 3	Pin 4	Pin 5	Pin 7	Pin 2	Pin 6	
	55 DC	0	6.3 AC	0	55 DC	-20 DC	-20 DC	
							NEGATIVE	

CONDITIONS OF MEASUREMENT: Coil A is inserted in coil socket. OSCILLATOR-DIODE switch set to OSCILLATOR position. ON-OFF switch set to ON. SENSITIVITY control set to obtain approximately half-scale reading on meter. Negative voltages are so indicated by a minus (-) sign, positive voltages have no sign. All voltage measurements made to chassis ground. Measurements given were made with a 20,000 Ω /V VOM. Operating line voltage at which measurements are made is 117VAC, 60 cps. NOTE: ALL VOLTAGE & RESISTANCE VALUES MAY NORMALLY VARY BY \pm 15%.

RESISTANCE CHART

TERMINAL BOARD TB1	Lug 2	CONDITIONS OF MEASUREMENT: 710 line cord disconnected from AC outlet. No coil plugged into coil socket. OSCILLATOR-DIODE switch set at DIODE position. ON-OFF switch set at OFF position.		
	1 MegΩ or more*			
TUBE SOCKET XV1	Pins 1 & 7	Pins 2 & 6	Pins 3 & 5	Pin 4
	1 MegΩ or more*	10kΩ	0	0

*After one minute

TROUBLE-SHOOTING CHART

This chart is based on the assumption that all wiring is correct. All symptoms include assumption that the line cord is connected to the 117VAC, 60 cps line and the ON-OFF switch S2 is set at ON. M1 is meter, I1 is pilot lamp, R1 is SENSITIVITY control, S1 is OSCILLATOR-DIODE switch.

SYMPTOM	POSSIBLE CAUSE	CHECK/REMEDY
S1 at OSC., I1 not lit.	S1, S2 defective T1 defective	Replace Replace
M1 does not read with R1 adjusted to mid-rotation		
S1 at DIODE, I1 lit.	S1 defective	Short two lugs of S1 with jumper. If M1 reads, replace S1
Throwing S1 to OSC. with coil plugged in and R1 at mid-rotation does not result in M1 reading	T1 defective	Check AC voltage between T1 secondary leads (red). If absent, replace T1
	CR1 defective	Replace
S1 at DIODE, I1 lit. Throwing S1 to OSC. dims I1.	Short in B+ supply Most likely shorted C7 or C6	Replace
With S1 at OSC., and any coil except H plugged in, it is impossible to obtain full-scale reading on M1 at maximum sensitivity setting of R1	Low B+ voltage Tube V1 defective Low AC line voltage (below 100 VAC)	C7, C6 defective. Replace Replace Check voltage. Booster transformer may be required if condition is usual
M1 does give any indication. Operation otherwise seems normal	M1 defective Normally closed PHONE jack is open	Replace Clean or replace
M1 reading erratic. Reading jumps while tuning	Dirt between wiper spring and shaft of C8	Clean with benzine
S1, S2, R1 do not slide or turn freely	Front panel misaligned against chassis	Loosen 4 screws which hold front panel and position it so that the controls are centered in the panel openings and no rubbing can occur. Re-tighten 4 screws.
TUNING knob rubs against tube side	Tube bracket accidentally bend	Bend tube bracket further away from TUNING knob with long-nose pliers

SERVICE

If trouble develops in your instrument which you can not remedy yourself, write to our service department listing all possible indications that might be helpful. If desired you may return the instrument to our factory where it will be placed in operating condition for \$5.00 plus the cost of parts replaced due to their being damaged in the course of construction. NOTE: Before returning this unit, be sure all parts are securely mounted. Attach a tag to the instrument, giving your home address and the trouble with the unit. Pack very carefully in a rugged container, us-

ing sufficient packing material (cotton, shredded newspaper, or excelsior), to make the unit completely immovable within the container. The original shipping carton is satisfactory, providing the original inserts are used or sufficient packing material inserted to keep the instrument immovable. Ship by prepaid Railway Express, if possible, to Electronic Instrument Co., Inc., 33-00 Northern Blvd., Long Island City 1, New York. Return shipment will be made by express collect. Note that a carrier cannot be held liable for damages in transit if packing IN HIS OPINION, is insufficient.

PARTS LIST

Stock #	Symbol	Description	Am't.
22559	C1, 2	cap., disc, ceramic, 90uuf ±5%	2
22561	C3, 4, 5	cap., disc, ceramic, 2200uuf ±5%	3
23015	C6	cap., electrolytic, 50uf 150V	1
23028	C7	cap., electrolytic, 10uf 150V	1
29012	C8	cap., variable	1
93004	CR1	rectifier, selenium	1
92000	I1	bulb, #47	1
50010	J1	jack, phone	1
97042	J2	coil, jack	1
74004	M1	meter, 500 uA	1
16018	R1	pot., miniature, 2.5K	1
10400	R2	res., 10K, 1/2W, ±10%	1
10421	R3	res., 6.8K, 1/2W, ±10%	1
10532	R4	res., 2K, 1/2W, ±5%	1
62001	S1, 2	switch, slide SPST	2
30028	T1	transformer, power	1
54008	TB1	term. board, 4 post	1
54005	TB2	term. board, 2 post right, w/gnd.	1
90053	V1	tube, 6AF4A	1
97714	X11	pilot light assembly	1
97022	XV1	socket, 7 pin miniature	1
35039	A	coil, 400 to 700kc	1
35040	B	coil, 700 to 1380kc	1
35041	C	coil, 1380 to 2900kc	1
35042	D	coil, 2.9 to 7.5mc	1
35043	E	coil, 7.5 to 18mc	1
35044	F	coil, 18-42mc	1
35045	G	coil, 42-100mc	1
35046	H Loop	coil, 100-250mc	1
40000		nut, hex 6-32 x 1/4	2
40007		nut, hex #4-40 x 1/4	8
40037		nut, hex (for miniature pot) #1-64 x 5/32	2
40034		nut, tin., #4	4
40038		nut, hex (for min. phone jack) 1/4-32 x 3/8	1
41015		screw, flat head 6-32 x 3/8	2
41016		screw, bd. head, 4-40 x 1/4	13
41023		PK, bd. head, #4 x 1/4	3
41067		screw, #4-40 x 5/8	1
41068		screw, #4-40 x 1/8	4
41069		set screw, (for large gear & tun. knob) 6-32 x 1/8	2
41070		set screw, (for bevel gear) 3-56 x 1/8	1
42007		washer, lock #4	9
42023		washer, lock 1/4" I.D.	1
42049		washer, flat 17/64 I.D. (min. phone jack)	1
43006		lug, ground #4	3
43000		lug, ground #6	1
44013		spacer, 29/64" long	1
46010		grommet, rubber 5/16 dia.	1
47005		spring	1
47502		large gear assembly	1
47503		bevel gear and drum assembly	1
47504		tuning knob assembly	1
57000		line cord	1
58004		wire, hook-up, thin wall	length
58300		spaghetti	length
58501		wire, bare	length
80041		panel	1
81158		chassis	1
81159		chassis "U" bracket	1
88024		cabinet	1
89605		window, plastic	1
89613		sleeve for #47 bulb	1
66076		manual of instruction (wired)	1
66330		manual of instruction (kit)	1
89627		capsule, glue	/

CAPACITOR COLOR CODES

RMA 3-DOT COLOR CODE FOR MICA-DIELECTRIC CAPACITORS

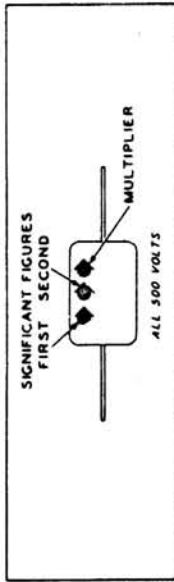

JAN 6-DOT COLOR CODE FOR PAPER-DIELECTRIC CAPACITORS

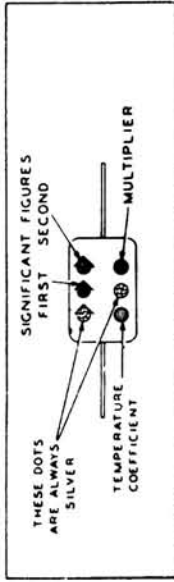

RMA 6-DOT COLOR CODE FOR MICA-DIELECTRIC CAPACITORS

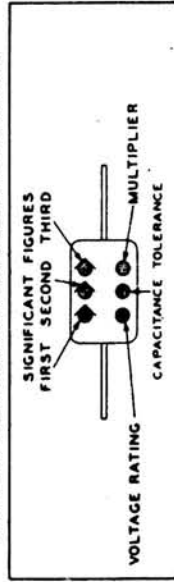

JAN 6-DOT COLOR CODE FOR MICA-DIELECTRIC CAPACITORS

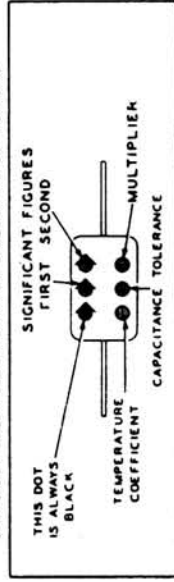

RMA COLOR CODE FOR TUBULAR CERAMIC-DIELECTRIC CAPACITORS

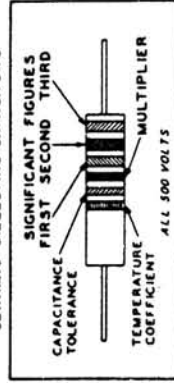

JAN COLOR CODE FOR FIXED CERAMIC-DIELECTRIC CAPACITORS

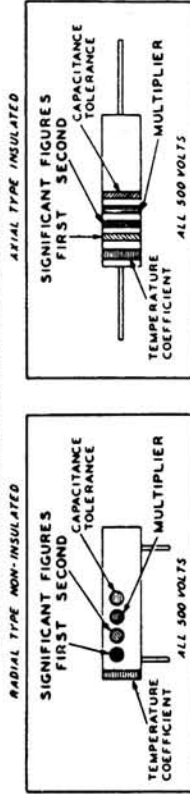

RMA: RADIO MANUFACTURERS ASSOCIATION
JAN: JOINT ARMY-NAVY

RESISTORS		CAPACITORS			
TOLERANCE	MULTIPLIER	RMA MICA AND CERAMIC-DIELECTRIC	JAN MICA AND CERAMIC-DIELECTRIC	JAN CERAMIC DIELECTRIC	TEMPERATURE COEFFICIENT
	1	1	1	1	A
	10	10	10	10	B
	100	100	100	100	C
	1000	1000	1000	1000	D
	10000	10000	10000	10000	E
	100000	100000	100000	100000	F
	1000000	1000000	1000000	1000000	G
	10000000	10000000	10000000	10000000	
	100000000	100000000	100000000	100000000	
5	0.1	0.1	0.1	0.1	
10	0.01	0.01	0.01	0.01	
20					

RESISTOR COLOR CODES

RMA COLOR CODE FOR FIXED COMPOSITION RESISTORS

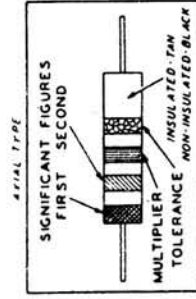

RADIAL TYPE

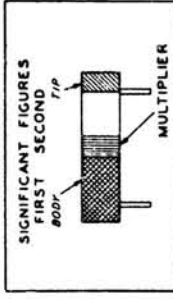

JAN COLOR CODE FOR FIXED COMPOSITION RESISTORS

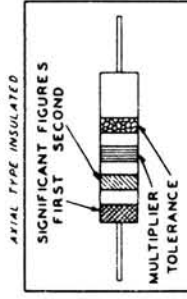

RADIAL TYPE NON-INSULATED

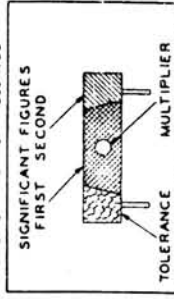

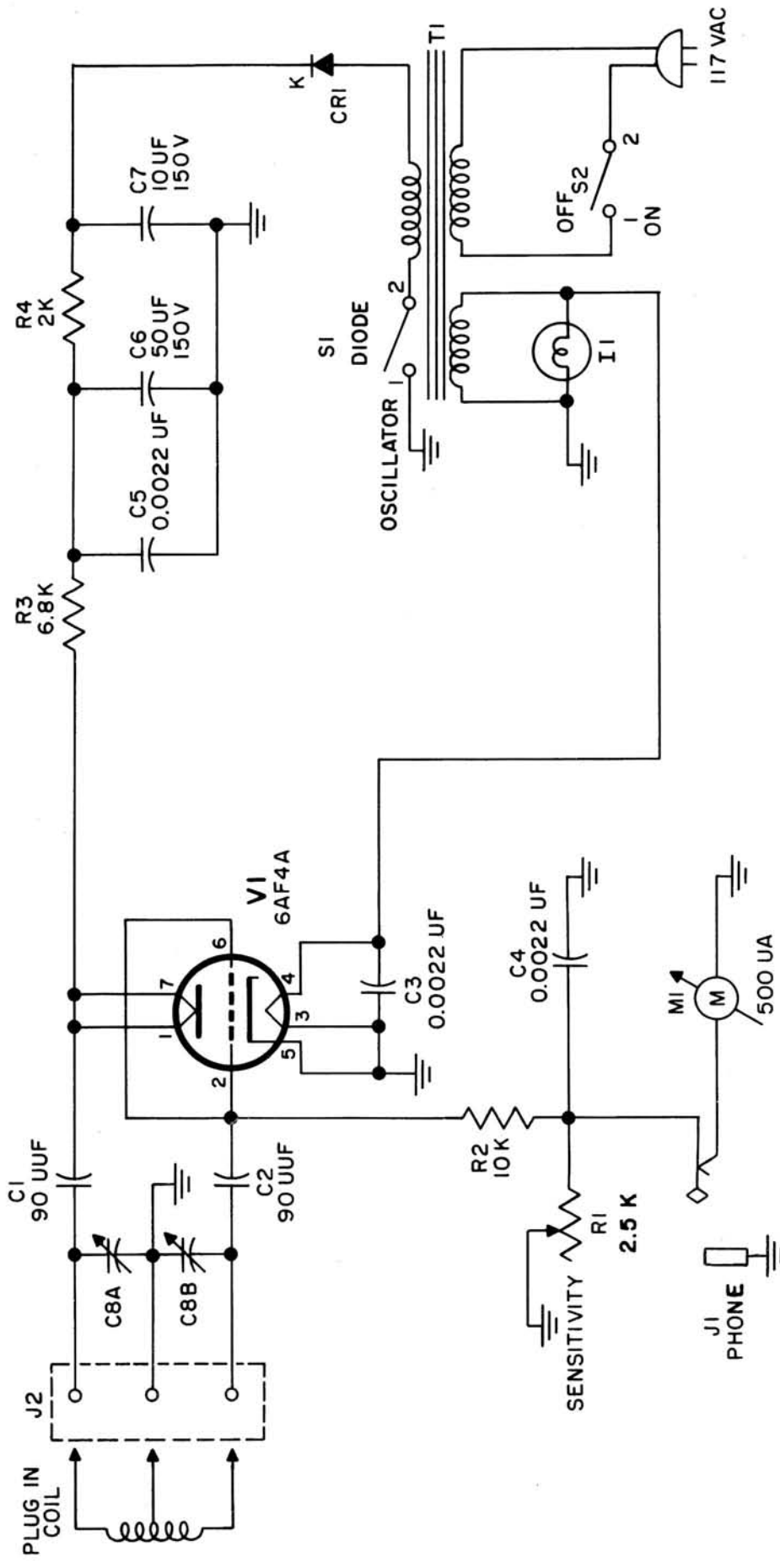

ELCO

MODEL 710 GRID DIP METER



EICO

Service Policy

PARTS REPLACEMENT

If it appears that a component is defective, and you desire a replacement, contact your nearest EICO Authorized Service Agency or our Customer Service Department.

If you are claiming the right to a no-charge replacement under the terms and conditions of the warranty, it is required that you shall have sent in the registration card within 10 days of the date of purchase, and that you send back the defective part transportation prepaid. In claiming warranty service or parts, please send or show your original sales slip plus the IBM card from the carton. EICO or its authorized agency will make the necessary replacement at no charge for parts eligible under the terms and conditions of the warranty. In returning tubes, pack them very carefully to avoid breakage in shipment. Broken tubes will not be replaced. Please read the warranty on the subject of parts eligible for replacement.

Further information required on a part returned for a no-charge replacement under the terms and conditions of the warranty is as follows:

- a) Model number and serial number, if any, of unit. Also any code numbers in red under the words INSTRUCTION MANUAL on the cover of the book supplied with the unit.
- b) Stock number and description of part as given on the parts list. If the part is not listed (of itself) in the parts list, it means that the part is integral with a sub-assembly, which we consider replaceable only as an entity. Parts integral with a sub-assembly may be listed in the parts list, so identified, if we consider that some or all of the parts may be individually replaced in the field under appropriate circumstances. If your unit is out of warranty, you are generally advised to order a replacement sub-assembly.
- c) Describe as completely as possible the nature of the defect, or reason for requiring replacement.

REPAIR SERVICE

EICO maintains a national network of authorized service agencies for in-warranty or out-of-warranty repair of EICO equipment. It is intended to serve those customers who are not sufficiently familiar with electronics to make use of the EICO Service Consultation facilities, or whose difficulties cannot be solved by correspondence.

For all out-of-warranty units, there is a minimum labor and handling fee. Charges for parts replaced are additional to the minimum fee.

For in-warranty completed kit units, there is a minimum labor and handling fee. There is no charge for a replaced defective part provided that the terms and conditions of the warranty for no charge replacement are not violated in the judgement of EICO.

For in-warranty factory-wired units, there is no charge for labor or parts if the unit complies with the terms and conditions of the warranty in the judgement

of EICO. However, if the terms and conditions of the warranty are violated there will be a charge for labor plus parts.

In all cases, the unit must be sent to the factory or service agency transportation prepaid, and the unit will be returned to the customer transportation collect.

On kits, the services rendered for the minimum labor and handling fee are the correction of any minor wiring errors (not extensive corrections or rewiring), the labor involved in replacing defective parts, and any adjustments, alignment, or calibration procedures that would normally be performed on a factory-wired unit. Units not wired according to instructions, or modified in any way, or showing evidence of the use of acid core solder, will not be serviced and will be returned to the customer forthwith.

SEE OUR SCHEDULE OF SERVICE CHARGES

Units requiring extensive corrections or rewiring will incur an additional labor charge. An advance estimate will be submitted.

Please note: minimum labor and handling fees and service charges are subject to revision at any time.

LOCAL REPAIR FACILITIES

A list of authorized service stations is provided with this manual. The roster of stations may change from time to time, and if considerable time has elapsed since you purchased your unit, you are advised to contact the station you choose before sending the unit to them for repair. Use of a local service station will often result in faster service, and, usually, lower transportation costs.

It is necessary that you comply with the Shipping Instructions that follow when sending in a unit for service.

SHIPPING INSTRUCTIONS

You are strongly advised to retain the original shipping carton and inserts should reshipment be required for service or any other purpose. The carton may be collapsed for storage in as small a space as possible. In very many cases, the same carton is used for kit and factory-wired units so that the kit carton will serve for reshipment of the completed kit.

When sending a unit for service pack the unit very carefully, preferably in the original shipping carton with the original inserts.

If this is not possible, use a strong oversize carton, preferably wood, and using at least 3 inches of resilient packing material such as shredded paper or excelsior inserted between all sides of the unit and the carton. Seal the carton with strong gummed paper tape or strong twine or both. Attach a tag to the instrument on which is printed your name and address and brief reference to the trouble experienced. Affix "FRAGILE" or "HANDLE WITH CARE" labels to at least four sides of the carton or print these words large and clear with a bright color crayon. Ship prepaid.

Include your name and address on the outside of the carton. Return shipment will be made transportation charges collect. Note that a carrier cannot be held liable for damage in transit, if packing, IN HIS OPINION, is insufficient.

EICO ELECTRONIC INSTRUMENT CO., INC.
131-01 39th Ave., Flushing, N.Y. 11352

AUTHORIZED WARRANTY SERVICE AGENCIES

ALABAMA

Birmingham
Godwin Radio Co.
3131-4th Avenue S.
Prince Radio Co., Inc.
2208-2nd Ave. N.
Mobile
Universal Electronics & Instr. Svce.
3058 Brookline Dr. W.
(Instr., CB & Ham Only)

ARIZONA

Phoenix
Stereo Specialists
4807 North Central
(Hi-Fi Only)

Tucson
Park Music Shop
1702 E. Speedway

CALIFORNIA

Anaheim
United Sound & TV Co.
2010 W. Lincoln Ave.

Barstow
Roy's Communications Svce.
615 E. Main St.

Los Angeles
Electronic Instrument Service
8907 So. Vermont Ave.

United Sound & TV Co.
5036 Venice Blvd.

San Diego
Lewton's Radio & TV
4251 University Ave.
(High Fidelity Only)

San Francisco
Prompt Radio & TV Co.
3143 Mission St.
(Hi-Fi & Tape Recorders only)

COLORADO

Colorado Springs
Clyde N. Still
2630 W. Kiowa St.

Denver
A. B. & K. Service, Inc.
1459 South Pearl St.

CONNECTICUT

West Hartford Center
Herbert Electronics
959½ Farmington Ave.

New Haven
Baltimore Electronics
546 Whalley Ave.
(Hi-Fi Only)

Norwich
La Course Radio-Electric Svce.
184 Franklin St.

DISTRICT OF COLUMBIA

Washington
Sylvan Radio & TV Co.
306 Kennedy St., N. W.

FLORIDA

Miami
Southern Authorized Factory Service
62 N. W. 27th Ave.

Spire Audio-Visual Co.
24 N. W. 36th St.

North Miami Beach
Southeastern Communications, Inc.
2055 N. E. 151st St.

Orlando
Electronic Service Labs.
1024 N. Mills
Electro-Tech., Inc.
307-27th St.
(Instruments Only)

Tampa
Maurice Wood
5812 Gomez St.

GEORGIA

Hapeville
Electro-Tech, Inc.
3020 Commerce Way
(Instruments Only)

HAWAII

Honolulu
CAATEX Corp.
1223 Hopaka St.

IDAHO

Twin Falls
TV Tuner Service
P. O. Box 793

ILLINOIS

Oak Park
B & S Electronics, Inc.
6326 W. Roosevelt Rd.

Chicago
Electronic Engineers, Inc.
5615 W. Division St.

Springfield
Stelte Communication Engineers
1700 East Jackson St.

INDIANA

Indianapolis
Aid TV & General Appliance
4145 North College Ave.

Component Electronics
319 W. Maryland St.

La Grange
Westview Electronics
R. R. 4

IOWA

Sioux City
Mar-Bon, Inc.
Route 2, Box 138
(CB & Ham Only)

KANSAS

Wichita
Alan Appliance Service, Inc.
339 North Main St.

KENTUCKY

Louisville
Maury's Fluorescent & Appl. Svce
962 South 3rd St.

LOUISIANA

Kenner
Coastal Electronics
2114 Williams

Lake Charles
TEK Service, Inc.
212 Ridge View Drive
(Instruments Only)

Metairie
Airline Electronic Svce.
3626 Airline H'way

MAINE

Portland
Air-Tronics
987 Westbrook St.

MARYLAND

Baltimore
Clayton Electronics, Inc.
4723 Gwynn Oak Ave.

Bethesda
American Technical Services
4961 Bethesda Ave.

MASSACHUSETTS

Boston
Park Armature Co.
1218-30 Columbus Ave.

Medford
Electron Service Ctr.
229 Salem St.

Pembroke
South Shore Instrument Labs.
20 Chapel St.
(Instruments Only)

Somerville
Electronic Repair Svce.
206-208 Highland Ave.

Worcester
Audio-Visual Associates
8 Boylston St.

MINNESOTA

Minneapolis
Andersen Audio Laboratory
4145 Minnehaha Ave. South

MISSOURI

Kansas City
Carroll Electronics
2410 Grand Ave.

St. Louis
Scherrer Instruments
5449 Delmar Blvd.
A. A. Kelley Radio & Elect. Svce.
4181 Manchester

NEBRASKA

Lincoln
Northland Electronics
1601 "P" St.

Omaha
Hi-Pix Stereo Service
3427 S. 42nd St.

NEW JERSEY

Jamesburg
Universal Television Svce.
39 E. Railroad Ave.

Newark
Associated Electronics
464 Orange St.
(Hi-Fi & Tape Recorders Only)
Warranty Radio & TV
750 S. Orange Ave.
(Instruments, CB & Ham Only)

Riverside
Dixey-Bonas TV
52 Scott St.

Wayne
Hosica Laboratories
100 Parish Drive

NEW MEXICO

Albuquerque
Ed's TV & HI-FI
301 Maple Ave. N. E.

NEW YORK

Albany
Baker Electronics
514 Second St.

Binghamton
Ross' Radio & TV Service
116 Main St.

Hastings on the Hudson
(Westchester County)
Central TV & HI-FI Service
543 Warburton Ave.

Huntington Station
Suffolk Sound Repair, Inc.
1671 New York Ave.

New Hyde Park
Ethical Electronic Service
3330 Hillside Ave.

New York City
Manhattan
Winters' Radio Laboratory
11 Warren St.

Brooklyn
G. M. T. V.
252 Prospect Park West

Queens
H & E Clock and Elect. Corp.
144-33 Jamaica Ave.

Syracuse
Radio & Electronic Svce.
401 N. Townsend St. at Willow

Vestal
Compton Industries, Inc.
333 Vestal P'kway East

West Hempstead
Audotronic, Inc.
96 Hempstead Turnpike

NORTH CAROLINA

Charlotte
Electro-Tech, Inc.
3107 Cullman Ave.
(Instruments Only)

Tryon Repair Service
3125 Tuckaseegee Rd.

Raleigh
Speed Instrument Co.
3028 E. Rothgeb Dr.
(For Instruments Only)

OHIO

Cleveland
Bob Whitlow Radio & TV
13914 St. Clair Ave.

Dayton
Far Hills Service Center
51 W. Whipp Rd.

Toledo
Don's Electronics
1682 Belmont Ave.
(Hi-Fi & Tape Recorders Only)

OREGON

Lebanon
Lines Communications
RR Box 226X
(C-B Only)

PENNSYLVANIA

Delmont
Eltron Electronics
P. O. Box 99

Havertown
Michael's TV & Radio Service
1127 West Chester Pike

Lehighton
Lehighton Electronics
P. O. Box 281

Philadelphia
Electronic Servicenter
13 S. 21st St.
Transistor Eqpt. Service Ctr.
2212 Glendale St.

Pittsburgh
Scott's Electronic Svce.
2280 Lutz Ave.

Woodlyn
(Suburban Philadelphia)
Altron Electronics Co.
1309 Jefferson Ave.

TEXAS

Austin
Park Forest TV
2601 South First

Dallas
Electromec Co.
926 Industrial Blvd.

El Paso
Test Equipment Co.
5319 Harlan Dr.

La Feria
La Feria Radio & TV Service

San Antonio
Electronics Unlimited
4404 San Pedro

Texas City
Ham's Communication Svce.
3001 Somerset Ave.

Wichita Falls
Ken Dixon Radio & TV
2612 Grant St.

UTAH

Bountiful
Anderton Electronic Lab.
129 E. 1800 South

VIRGINIA

Arlington
Washington Electronic Service Co.
122 South Wayne St.

WASHINGTON

Seattle
Ron Merritt Co.
1320 Prospect St.

CANADA

Toronto, Ontario
John R. Tilton, Ltd.
51 McCormack St.

Vancouver
National TV Service Co., Ltd.
2145 Commercial Drive

NEW ZEALAND

Auckland
John Gilbert & Co., Ltd.
Anzac Ave.

MODEL 710-2 (KIT) ADDENDA

Please make the following change in your Model 710 Instruction Book.

1. Page 10. Add the following item to your parts list:

89627 capsule, glue 1

2. Page 10. Under stock #89605, in the description, omit the phrase in the parenthesis (mounted on panel).

Please add the following to page 2C in your Construction Book.

Gluing Plastic Window to Panel

Place the panel with the printing face down on a table. Exercise the necessary precautions not to scratch the panel. The large round hole in the bent section of the panel should be towards you.

Note the trapezoidal cutout in the middle of the larger flat section of the panel. The shortest side of this cutout is towards you. A vertical line is inscribed across the center of the cutout. This will be one of the guide lines used to align the plastic window when gluing it to the panel.

The second line is perpendicular to the first line and is just below the shortest side of the trapezoidal cutout.

Peel off the protective paper coating from each side of the plastic window.

A line has been inscribed on one of the flat sides of the plastic window. Run your fingernail over each flat side of the window to determine on which side the line has been inscribed. Hold the window with this side facing towards you.

A 3/8" hole has been drilled through one side of the window. Orient the plastic window so that this hole is at your right. When oriented properly, the inscribed line is facing towards you and the 3/8" hole is at your right. In this position place the window on the table next to the panel.

Cut the tip of the glue capsule with a pair of scissors. Caution: Capsule is not to be swallowed. It is not for internal use.

Squeezing the capsule, apply a liberal amount of glue just above and to the right of the trapezoidal opening in the panel, and somewhat less glue to the left of the trapezoidal opening in the panel. Do not apply glue any closer than 1/8" to the trapezoidal opening on any side. In this way you will avoid getting glue on the edges of the cutouts and on the window.

MODEL 710-2 (KIT) ADDENDA

Align the vertical line on the window with the vertical line inscribed on the panel and the bottom of the window with the horizontal line inscribed on the panel. Place the window as just indicated on the panel. Do not rotate the window substantially from the position on the table.

When mounted properly, the window is on the panel with the inscribed line facing you and the 3/8" hole at your right. The inscribed line in the window is located precisely at the center of the cutout.

Press the window gently against the panel. Do not allow the glue to run into the trapezoidal cutout. Do not place any weight on the panel or window.

Put the panel with the glued window aside to dry for at least six hours.

I. E. 1281 Electronic Instrument Co., Inc., Long Island City 1, N. Y.

7/7/59

MODEL 710-1 & 2 ADDENDA

Please make the following changes to your Model 710 Construction Book:

Page 4C - Mark the screw going through the standoff "#4-40 x 5/8 screw".

Page 4C - Omit the standoff

Page 5C, Step 5. - Omit the sentence: "From above the chassis, place a spacer over the screw". In place of this sentence, substitute: "Rest the capacitor on the variable capacitor support bracket".

Note: This variable capacitor support bracket is not shown in Fig. 2. It is a small angle bracket welded to the chassis (large flat surface). The chassis supplied with the kit is supplied with this bracket welded to its surface near the hole for the #4-40 x 5/8 screw.

Page 10. Omit Stock #44013, spacer, from the parts list.

I.E. 1266 Electronic Instrument Co., Inc., Long Island City 1, New York

MODEL 710-2 ADDENDA

Please make the following changes in your parts list:

Lug, ground #4, (3 required); stock #43006 was 43000
Lug, ground #6, (1 required); stock #43000 was 43006
40007, nut hex, #4-40 x $\frac{1}{4}$, 8 required was 9 required.

I. E. 1580 EICO Electronic Instrument Co., Inc.
131-01 39th Avenue, Flushing, New York