

MARCH 1980 Volume 5, Number 3 \$2.50 in USA/\$2.95 in Canada

BYTE[®]

the small systems journal

A MCGRAW-HILL PUBLICATION

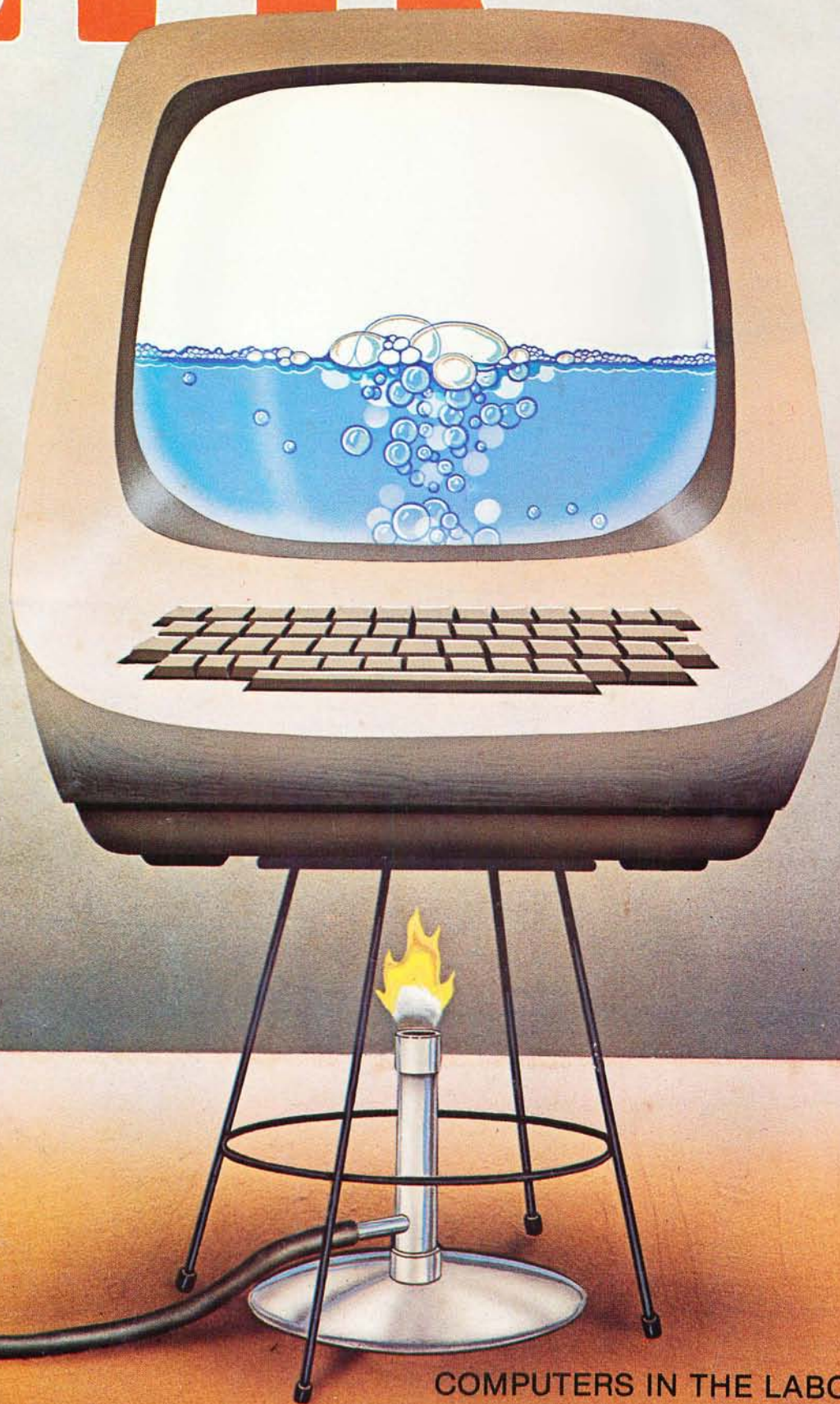

ROBERT
30 111117

COMPUTERS IN THE LABORATORY

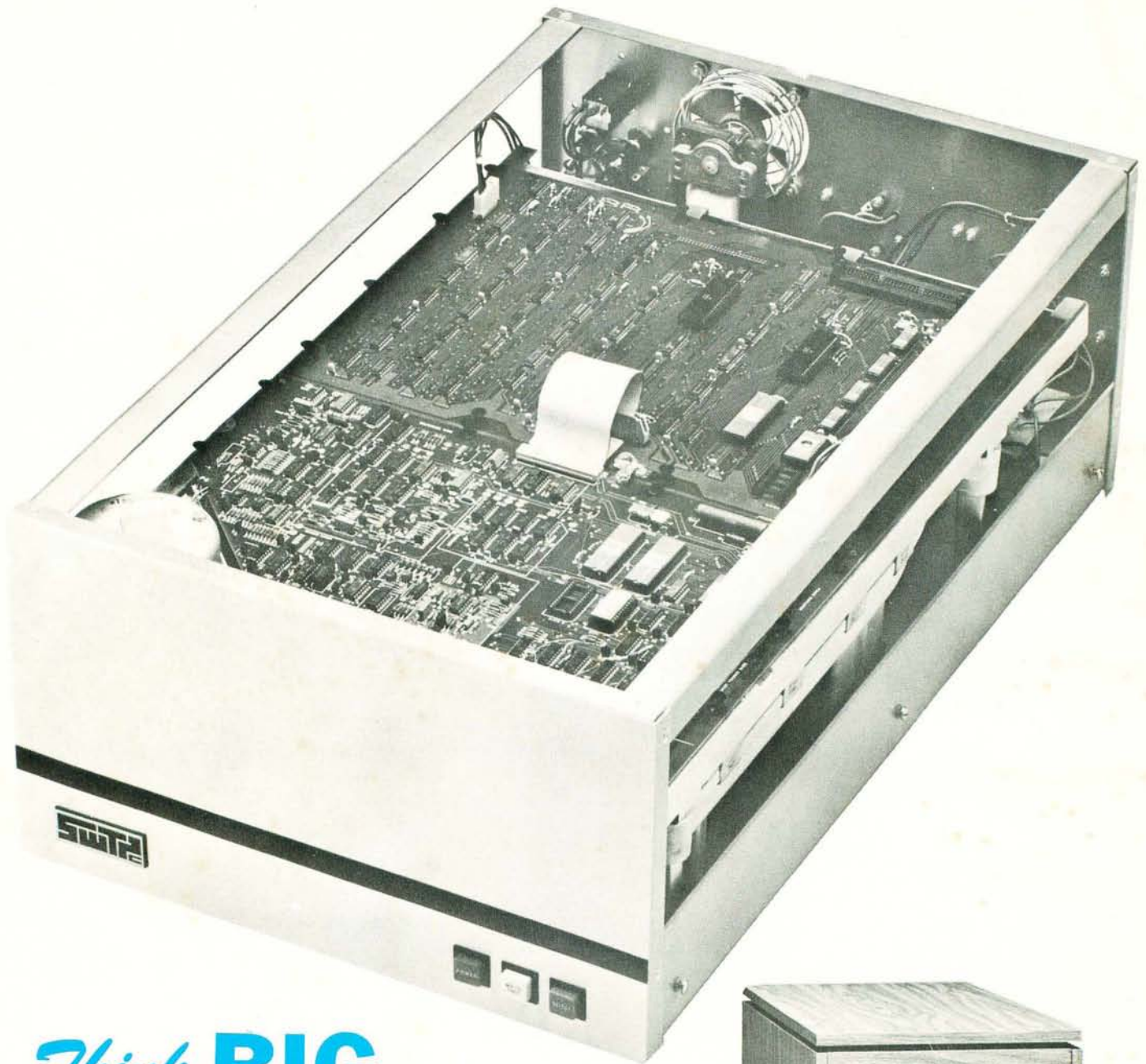

Think **BIG**

State of the art "Winchester" type hard disk with a data storage capacity of nearly 16 Megabytes, makes the SWTPC 6809 system the most flexible as well as the most powerful eight-bit microcomputer system in the world. The intelligent controller, using DMA data transfer, makes maximum use of the "Winchester" capability. It is completely compatible with the FLEX9 operating system used on the SWTPC 6809 floppy disk system.

CDS-1 "Winchester" disk drive with controller . . \$3,995.00
Cabinet—matching our 6809 computer desk . . . \$150.00



SOUTHWEST TECHNICAL PRODUCTS CORPORATION
219 W. RHAPSODY
SAN ANTONIO, TEXAS 78216

(512) 344-0241

Circle 279 on inquiry card.



Low-cost hard disk computers are here and field proven

11 megabytes of hard disk and 64 kilobytes of fast RAM in a Z80A computer for under \$10K. Two floppy drives, too. Naturally, it's from Cromemco.

It's a reality. In Cromemco's new Model Z-2H you get all of the above and even more. With Cromemco you get it all.

In this new Model Z-2H you get not only a large-storage Winchester hard disk drive but also two floppy disk drives. In the hard disk drive you get unprecedented storage capacity at this price—11 megabytes unformatted.

You get speed—both in the 4 MHz Z80A microprocessor and in the fast 64K RAM which has a chip access time of only 150 nanoseconds. You get speed in the computer minimum instruction execution time of 1 microsecond. You get speed in the hard disk transfer rate of 5.6 megabits/sec.

EXPANDABILITY

You get expandability, too. The high-speed RAM can be expanded to 512 kilobytes if you wish.

And the computer has a full 12-slot card cage you can use for additional RAM and interface cards.

BROADEST SOFTWARE SUPPORT

With the Z-2H you also get the broadest software support in the

microcomputer field. Software Cromemco is known for. Software like this:

- Extended BASIC
- FORTRAN IV
- RATFOR (RATional FORtran)
- COBOL
- Z80 Macro Assembler
- Word Processing System
- Data Base Management

with more coming all the time.

SMALL, RUGGED, RELIABLE

With all its features the new Z-2H, including its hard disk drive, is still housed in just one compact cabinet.

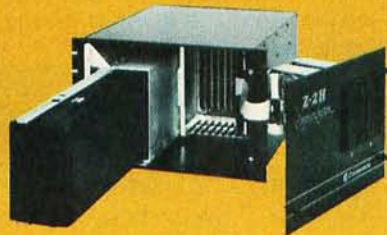

Hard disk drive at lower left can be interchanged just by sliding out and disconnecting plug. Seven free card slots are available. Z-2H includes printer interface card.

Included in that cabinet, too, is Cromemco ruggedness and reliability. Cromemco is time-proved. Our equipment is a survey winner for reliability. Of course, there's Cromemco's all-metal cabinet. Rugged, solid. And, there's the heavy-duty power supply (30A @ 8V, 15A @ +18 V, and 15A @ -18V) for circuitry you'll sooner or later want to plug into those free card slots.

SEE IT NOW

Last summer we told you this new Z-2H would be a smash. And it is. So see it at your dealer's now. Have him put you in touch with a user—there are lots of them because Cromemco has been delivering for months. See for yourself how pleased our users are.

PRESENT CROMEMCO USERS

We've kept you in mind, too. Ask about the new Model HDD Disk Drive which can combine with your present Cromemco computer to give you up to 22 megabytes of disk storage.



Cromemco
i n c o r p o r a t e d

280 BERNARDO AVE., MOUNTAIN VIEW, CA 94040 • (415) 964-7400
Tomorrow's computers today

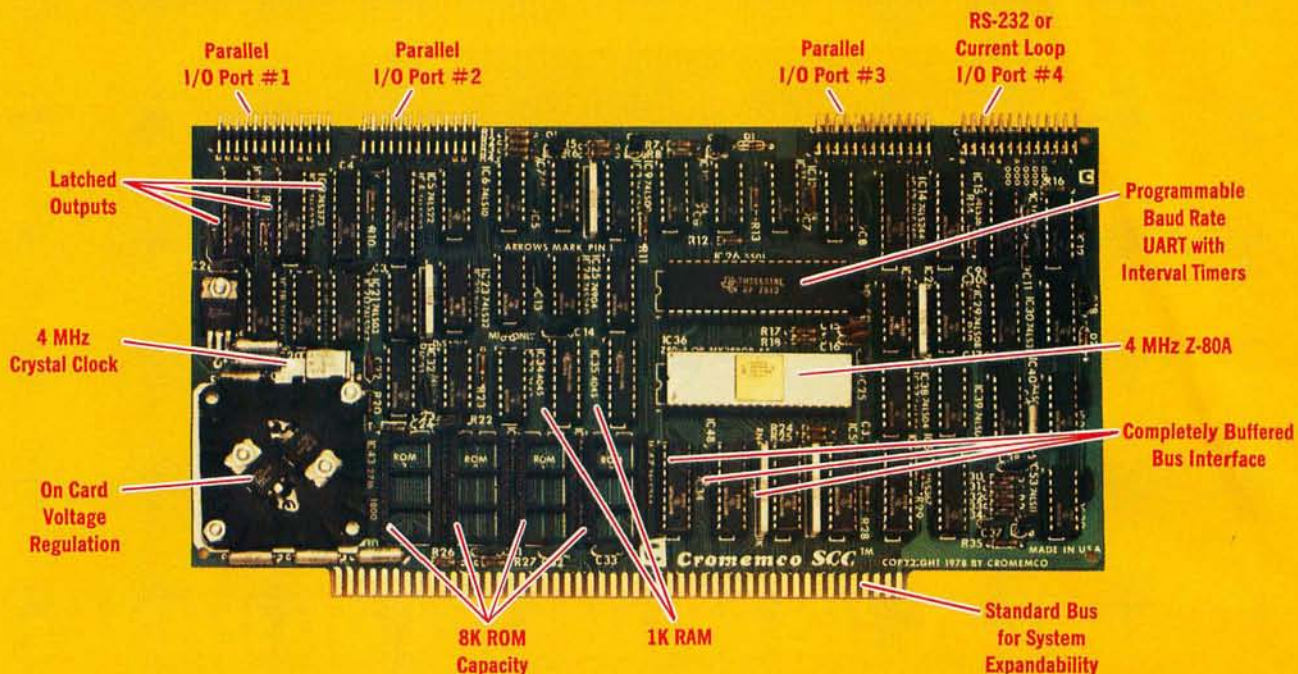

The single card computer with the features that help you in real life

COMPLETE COMPUTER

In this advanced card you get a professional quality computer that meets today's engineering needs. And it's one that's complete. It lets you be up and running fast. All you need is a power supply and your ROM software.

The computer itself is super. Fast 4 MHz operation. Capacity for 8K bytes of ROM (uses 2716 PROMs which **can be programmed by our new 32K BYTESAVER®** PROM card). There's also 1K of on-board static RAM. Further, you get straightforward interfacing through an RS-232 serial interface with ultra-fast speed of up to 76,800 baud — software programmable.

Other features include 24 bits of bi-directional parallel I/O and five on-board programmable timers.

Add to that vectored interrupts.

ENORMOUS EXPANDABILITY

Besides all these features the Cromemco single card computer gives you enormous expandability if you ever need it. And it's easy to expand. First, you can expand with the new Cromemco 32K BYTESAVER PROM card mentioned above. Then there's Cromemco's broad line of S100-bus-compatible memory and I/O interface cards. Cards with features such as relay interface, analog interface, graphics interface, optoisolator input, and A/D and D/A conversion. RAM and ROM cards, too.



Card Cage



32K BYTESAVER PROM card

EASY TO USE

Another convenience that makes the Model SCC computer easy to use is our Z-80 monitor and 3K Control BASIC (in two ROMs). With this optional software you're ready to go. The monitor gives you 12 commands. The BASIC, with 36 commands/functions, will directly access I/O ports and memory locations — and call machine language subroutines.

Finally, to simplify things to the ultimate, we even have convenient card cages. Rugged card cages. They hold cards firmly. No jiggling out of sockets.

AVAILABLE NOW/LOW PRICE

The Model SCC is available now at a low price of only \$450 burned-in and tested (32K BYTESAVER only \$295).

So act today. Get this high-capability computer working for you right away.



Cromemco
i n c o r p o r a t e d

Specialists in computers and peripherals

280 BERNARDO AVE., MOUNTAIN VIEW, CA 94040 • (415) 964-7400



page 6



page 17



page 60



page 114

Foreground

17 EASE INTO 16-BIT COMPUTING: GET 16-BIT PERFORMANCE FROM AN 8-BIT COMPUTER by Steve Ciarcia

Steve tells you how the Intel 8088 is well-suited for building a minimum-configuration 16-bit computer.

34 ELECTRON BEHAVIOR IN A CHEMICAL BOND by Michael Lieb

Learn how to use a computer to explore the inner processes of a molecule by finding solutions to the Schrödinger wave equation.

74 SOLVING PROBLEMS INVOLVING VARIABLE TERRAIN, PART 2: SPECIAL CASES, INCLUDING HEXAGONAL GRIDS by Scott T Jones

After developing a general algorithm last month, Scott now explores several modifications that may be applied to typical conflict-simulation problems.

126 A POWER-LINE PROTECTION CIRCUIT by Neil Schneider and Bror Erickson

For hobby applications where an isolation transformer is too big and expensive, this relay-based circuit can provide some protection from power-line wiring errors.

130 LANDING MODULE SIMULATION WITH RANDOM SURFACE by S J Houng

This game uses the Motorola MEK6800 D2 kit. It can be interfaced to display the landing approach on an oscilloscope.

142 THE DIRT-CHEAP BOOTSTRAP, MORE NOTES ON BRINGING UP A MICROCOMPUTER by Albert S Woodhull

An inexpensive way to add front-panel functions to a minimal microcomputer system.

156 HYDROCARBON MOLECULE CONSTRUCTOR, by Randall S Matthews

The program presented here uses the high-resolution graphics ability of the Apple II to give a visual representation of molecular bonding.

232 SUPER TIC by J Roehrig

This is a three-dimensional, 4-by-4-by-4, tic-tac-toe game that can play against a human opponent. The program has ten levels of expertise, is written in BASIC, and can be modified to run in two dimensions.

Background

60 HEWLETT-PACKARD'S NEW PERSONAL COMPUTER, THE HP-85

by Christopher P Morgan

A first look at a personal computer from a company esteemed for its calculators and minicomputers.

84 TRS-80 PERFORMANCE, EVALUATION BY PROGRAM TIMING

by James R Lewis

James provides us with a direct comparison of the TRS-80 computer with an IBM System/370.

114 ELECTRONIC PLANIMETRY by Peter A Santi, John Fryhofer and Gregory Hansen

These authors describe a situation in which a specialized tool was replaced by a general-purpose minicomputer.

194 OPERATION CODES FOR 8080, 8085, AND Z80 PROCESSORS

by D Martin Harrell

The need to convert an assembler mnemonic to the hexadecimal object code often occurs when programming the 8080 microprocessor family. Here is a helpful summary of related information.

230 TO ERR IS HUMAN by Roger A McGregor

Techniques to enable your computer to detect and correct typographical errors in assembly-language programs.

Nucleus

6 Editorial: Hunting the Computerized Eclipse

14 Letters

68, 212, 240 Programming Quickies: Gear-Ratio Calculations for Bicycle Derailleurs; and many more

108 BYTE News

168 Book Reviews

174 BYTE's Bits

176 Clubs and Newsletters

180 BYTE's Bugs

184 Product Review: Lucidata P-6800 Pascal

186 Technical Forum: The Direct Impact of the Computer; Cutting the Gregorian Knot

208 Desktop Wonder: The Periodic Chart at Your Fingertips....

218 Event Queue

246 What's New?

287 Unclassified Ads

288 Reader Service, BOMB

Publishers

Virginia Londoner, Gordon R Williamson

Associate Publisher

John E Hayes

Assistant

Jill E Callihan

Editorial Director

Carl T Helmers Jr

Editor in Chief

Christopher P Morgan

Editors

Richard S Shuford, Gregg Williams

Editorial Assistant

Faith Ferry

New Products Editor**Clubs, Newsletters**

Charles Freiberg

Drafting

Jon Swanson

Production Director

Nancy Estle

Senior Copy Editor

David William Hayward

Copy Editors

Faith Hanson, Warren Williamson,

Robin M Moss, Anthony J Lockwood

Production Art

Wai Chiu Li, Christine Dixon,

Holly Carmen LaBossiere, Deborah Porter

Typographers

Cheryl A Hurd, Debe L Wheeler,

Sherry McCarthy

Advertising Director

Thomas Harvey

Assistants

Ruth M Walsh, Marion Gagnon

Marketing Coordinator

Laura A Hanson

Circulation Manager

Gregory Spitzfaden

Assistants

Pamela R H Spitzfaden, Agnes E Perry,

Melanie Bertoni, Barbara Varnum

Dealer Sales

Anne M Baldwin

Receptionist

Jacqueline Earnshaw

Traffic Department

Mark Sandagata, Thomas Yanni

Controller

Daniel Rodrigues

Assistant

Mary E Fluhr

Advertising Billing

Karen Burgess

National Advertising Sales Representatives:

Hajar Associates Inc

East

280 Hillside Av, Needham Heights MA 02194

(617) 444-3946

521 Fifth Av, New York NY 10017

(212) 682-5844

Midwest

664 N Michigan Av, Suite 1010,

Chicago IL 60611 (312) 337-8008

West, Southwest

1000 Elwell Ct, Suite 227, Palo Alto CA 94303

(415) 964-0706/(714) 540-3554



ON THE COVER

This month's cover theme is "Computers in the Laboratory." Personal computers can be employed as a tool of analysis and control in scientific applications. We celebrate this theme with a fantasy suggestive of one area of scientific application: an advanced color-graphics-oriented personal computer is shown over a Bunsen burner on a beaker stand. On the terminal is a high-resolution image of some liquid boiling. This computer, without floppy-disk drives, certainly suggests a future direction: built-in, permanent mass storage with sufficient capacity to eliminate any need for removable media. We might even conjecture that a pattern is shown here being "boiled" into a bubble memory.

Officers of McGraw-Hill Publications Company: Paul F. McPherson, President; Executive Vice Presidents: James E. Boddorf, Gene W. Simpson; Group Vice President: Daniel A. McMillan; Senior Vice President-Editorial: Ralph R. Schulz; Vice Presidents: Kemp Anderson, Business Systems Development; Stephen C. Croft, Manufacturing; Robert B. Doll, Circulation; James E. Hackett, Controller; William H. Hammond, Communications; Eric B. Herr, Planning and Development; John W. Patten, Sales; Edward E. Schirmer, International.

Officers of the Corporation: Harold W. McGraw Jr, President, Chief Executive Officer and Chairman of the Board; Robert F. Landes, Senior Vice President and Secretary; Ralph J. Webb, Treasurer.

BYTE is published monthly by BYTE Publications Inc, 70 Main St, Peterborough NH 03458, a wholly-owned subsidiary of McGraw-Hill, Inc. Address all mail except subscriptions to above address; phone (603) 924-9281. Address subscriptions, change of address, USPS Form 3579, and fulfillment questions to BYTE Subscriptions, PO Box 590, Martinsville NJ 08836. Second class postage paid at Peterborough NH 03458 and at additional mailing offices—USPS Publication No. 102410 (ISSN 0360-5280). Canadian second class registration number 9321. Subscriptions are \$18 for one year, \$32 for two years, and \$46 for three years in the USA and its possessions. In Canada and Mexico, \$20 for one year, \$36 for two years, \$52 for three years. \$32 for one year air delivery to Europe. \$32 surface delivery elsewhere. Air delivery to selected areas at additional rates upon request. Single copy price is \$2.50 in the USA and its possessions, \$2.95 in Canada and Mexico, \$4.00 in Europe, and \$4.50 elsewhere. Foreign subscriptions and sales should be remitted in United States funds drawn on a US bank. Printed in United States of America.

Address all editorial correspondence to the editor at the above address. Unacceptable manuscripts will be returned if accompanied by sufficient first class postage. Not responsible for lost manuscripts or photos. Opinions expressed by the authors are not necessarily those of BYTE. Entire contents copyright © 1980 by BYTE Publications Inc. All rights reserved.

BYTE® is available in microform from University Microfilms International, 300 N Zeeb Rd, Dept PR, Ann Arbor MI 48106 USA or 18 Bedford Row, Dept PR, London WC1R 4EJ ENGLAND.



Subscription WATS Line: (800) 258-5485

Office hours: Mon-Thur 8:30 AM - 4:30 PM, Friday 8:30 AM - Noon, Eastern Time

**MICROANGELOTM
HIGH RESOLUTION
GRAPHICS SUBSYSTEM**

\$1995.00

Light Pen Optional



- 512 x 484 resolution display supervised by its own Z80 microprocessor
- 32K bytes of dual port memory give a completely undisturbed screen image
- Resident software emulates an ASCII terminal and provides graphics routines for point, line, region, and light pen usage, and more
- Compatible with any S-100 system, yet easily interfaced to other computers
- 72 key keyboard with graphics function keys
- 15" high performance monitor

SUBSYSTEMS

By
Micro Diversions

**WORDSMITHTM
VIDEO
SUBSYSTEM**
\$1595.00



- Wordsmith Word Processor software
- 40-line page display
- Selectric layout keyboard plus 20 Wordsmith function keys
- 15" high performance monitor
- Compatible with S-100 systems
- Complete documentation

Call or write:
Micro Diversions, Inc.
8455-D Tyco Road
Vienna, Virginia 22180
(703) 827-0888

**Look for
Shugart drives
in personal
computer systems
made by these
companies.**

Altos Computer Systems
2378-B Walsh Avenue
Santa Clara, CA 95050

Apple Computer
10260 Bandley Dr.
Cupertino, CA 95014

Commodore Business Machines, Inc.
3330 Scott Boulevard
Santa Clara, CA 95050

Digital Microsystems Inc.
(Formerly Digital Systems)
4448 Piedmont Ave.
Oakland, CA 94611

Industrial Micro Systems
633 West Katella, Suite L
Orange, CA 92667

North Star Computer
2547 9th Street
Berkeley, CA 94710

Polymorphic Systems
460 Ward Dr.
Santa Barbara, CA 93111

Problem Solver Systems
20834 Lassen Street
Chatsworth, CA 91311

Processor Applications Limited
2801 E. Valley View Avenue
West Covina, CA 91792

Technico Inc.
9130 Red Branch Road
Columbia, MD 21045

Texas Electronic Instruments
5636 Etheridge
Houston, TX 77087

Thinker Toys
1201 10th Street
Berkeley, CA 94710

Editorial

Hunting the Computerized Eclipse

by Carl Helmers

As noted last month, the subject of this editorial is completing some technical details of a project that has consumed all my spare time during the closing months of 1979. This project is the practical execution of what was really a pipe dream last March when the July 1979 editorial ("Computers and Eclipses") was written. The July editorial was inspired by my travels the previous February to see my first total solar eclipse from a roadside near Roundup, Montana. During that event, which took place in cold wintry weather, all my pictures were taken manually using the telephoto lens on my Nikon F2A camera. I knew there had to be a better way of controlling my camera during an eclipse event, and set about concocting a suitable first approximation of a computer-control method.

As a result of writing about the problem, I received a letter from and eventually met one of our readers, Norm Whyte, of Monte Rio, California. In the course of the ensuing correspondence and telephone calls, we developed a degree of friendship based on mutual interests in matters scientific and technological. The result was that since there were a couple of berths left in the travel plans for Norm's eclipse trip to Kenya during February 1980, I was able to become more serious about making a real version of the fantasy sketch outlined in last July's editorial.

With the decision to go made, the next decision was how to implement the system. The number one step, of course, was to order a motor drive and a magazine back for the Nikon camera. I quickly came to the conclusion that if I were going to travel all the way to Kenya to watch 4 minutes of celestial follies, more than thirty-six exposures would be appropriate. The Peterborough Camera Shop did their job, so by September I had the motor drive, and I had the magazine-back and bulk-loading accessories by mid-October. The camera system and methods of developing a 250-frame roll in a small batch tank were debugged at the camera store in November, through the efforts of its owner Wayne Esty and lab technician Skip DeLiquori.

At about this time, I began testing my refined concept of electrical control for the motor-drive/shutter mechanism. It took about 15 minutes to verify what I wanted to know: applying an ohmmeter and a miniature Phillips screwdriver to the detachable control head of the motor drive, I was able to determine the proper wiring of the four-wire MC-1 remote-control cable I had purchased. In the normal use of a Nikon motor drive, this cable serves as the electrical equivalent of a mechanical cable release.

In my application, I simply cut off and set aside the extension socket for the control head. In its place I wired an electronic simulation of the control head. This electronic simulation is the circuit of figure 1 (see page 10), which acts like the push-button switch of the motor drive head. One silicon diode is required in the logic which distinguishes between single shot and continuous firing of the motor drive.

The relatively machine-independent, Pascal language interface to the machine-dependent absolute addresses of the annunciator output ANO is provided through a variant record technique. This technique works in UCSD Pascal implementations such as Apple Pascal, but may not work in all implementations since it definitely "bends" the formal definition of the language.

 **Shugart**

If it isn't Shugart, it isn't minifloppy.™

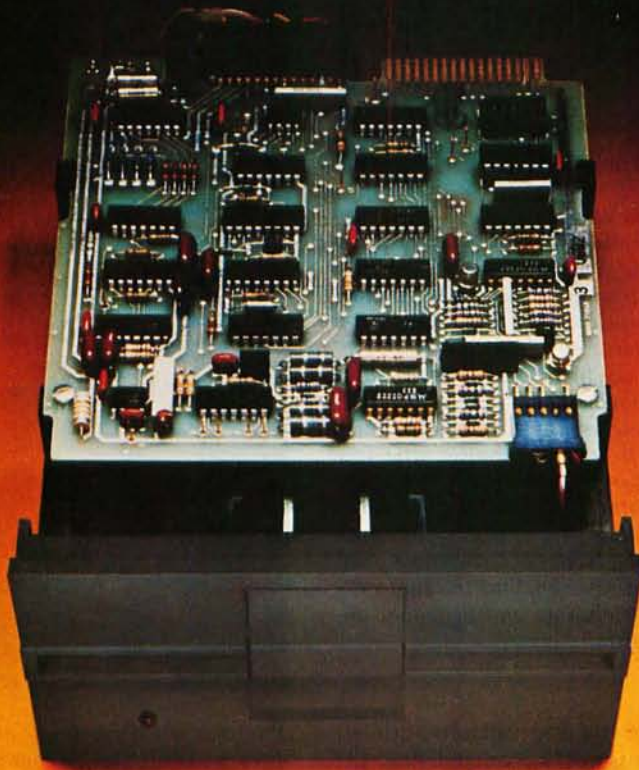

Shugart invented the minifloppy in 1976. Today there are more than 100,000 of the little drives in use. That's because users want the affordable random access data storage of the minifloppy.

Shugart packs years of proven floppy drive technology into this tiny package. Up to 110 kbytes of data storage. Fast random access of about one-half second. And high speed data transfer of 125 kbits per second. Plus sensible, maintenance-free features like write protect to prevent accidental data loss, an activity light to indicate when the drive is selected by your computer and a door interlock to protect your media from damage.

Our proprietary read/write head provides maximum data interchange margins, and it is

positioned precisely on the selected track by a patented spiral cam actuator. The DC drive motor with integral tachometer assures accurate diskette rotation and low heat dissipation. A die cast aluminum base plate provides a solid foundation for the drive.

At Shugart, technology leadership is more than a slogan, it's a commitment. Get reliability and value when you invest your money for floppy disk storage. Ask for the standard of the industry, minifloppy. If it isn't Shugart, it isn't minifloppy.

 **Shugart Associates**

435 Oakmead Parkway, Sunnyvale, California 94086

™ minifloppy is registered trademark of Shugart Associates

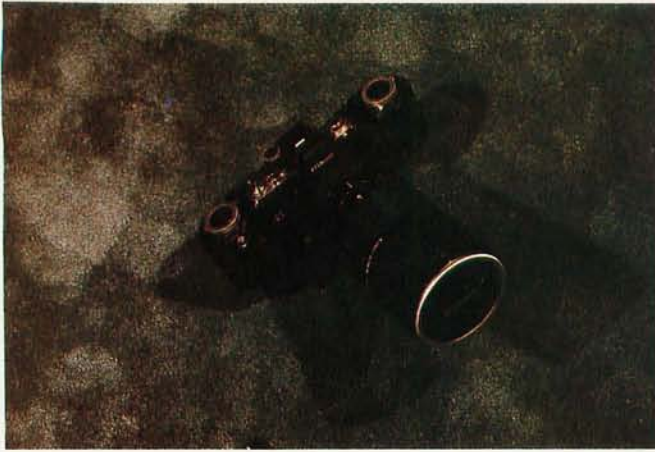

Photo 1: The Camera. The camera equipment has slightly expanded since originally conceived. The method of interfacing has also been greatly simplified. The camera now has a 250-exposure magazine back, which will be loaded with ASA 64 Kodak Ektachrome slide film. It turns out that the Nikon MD-2 motor drive allows direct computer control of camera operation, through a single bit interface (see figure 1). When the shutter speed control is in the "bulb" position, this single bit out of the computer controls exposure time and motor drive action.

A transition from 0 to 1 opens the camera shutter after flipping the reflex mirror out of the way; a transition from 1 to 0 closes the shutter and causes the motor drive to advance the film to the next frame. The optically isolated two-transistor interface is wired to the four conductors in the Nikon MC-1 remote shutter extension cable. Readers should refer back to the July 1979 BYTE editorial for a much more elaborate and probably unworkable mechanical kludge suggestion.

All one needs to do is reference the appropriate address. One address, if referenced, sets the ANO output line; the second address, if referenced, resets the ANO line. I could have used the Apple-dependent, machine-language routine called TTLOUT, but decided instead to use the variant record escape of setting a pointer to an integer address value. The test program of listing 4 was used to verify the operation of the circuit in figure 1.

At the stage of this editorial's writing during December 1979, I had created a Pascal program shown in listing 1 (with execution shown in listings 2 and 3 photographed from my terminal). This program represents the most difficult part of the model, allocating the detail exposure times for all the shots of the eclipse.

The advantages of using this high-level language become obvious whenever such an elaborate program is even contemplated. I started out with a first version of the program that defined the application-specific data types of "seconds," "milliseconds," "absolute-time," "exposures," and "an-exposure-detail." The records "absolute-time" and "an-exposure-detail" give examples of how Pascal may be used to create conceptually oriented data types for specific purposes.

In this real-time simulation, I chose to use the millisecond as the basic unit of time, with actual time values on the order of seconds expressed as a two-part record with an integer value 0 thru 999 of milliseconds and an integer value of 0 thru 32,767 of seconds. I chose to express time in this manner as a part of my original intention to use a small, single-board computer programmed in



Photo 2: Field computer equipment. My original plan was to take a small, single board computer for use in the field. However, as the winter solstice of 1979 was fast approaching, it became obvious that it would be far easier to simply take along the Apple II Pascal machine which has the complete simulation of the event written in a high-level form. Thus, I went hunting at a local computer store, where I came upon a truly elegant Apple II traveling case. (Contact Bob McGuffie, Computerland of Nashua, New Hampshire, if you want one. I paid \$108 for this product.) The case will accept two floppy-disk drives, the Apple, and the Sanyo miniature television which will be used as my field display. (At the eclipse field site, we will have 110 V AC power provided by a small gasoline generator.)

assembly language. Such an expression of the data would have made it easy to translate the high-level language simulation into a hand-crafted small program.

(After time started growing short and I had not yet received the small computer I had intended to use, I started asking skeptical questions like: "Why should I flagellate myself with a macroassembly language expression of a perfectly good program written in Pascal?" After all, this "big machine" with its new suitcase is certainly portable and has the single-bit output needed.)

The variables needed by the program are declared with long, explanatory names immediately following the TYPE declarations. Thus, whenever I need a variable which is intended to be an "absolute-time" value, I declare it using the application-specific type of that name.

Text continued on page 12

At Intersystems, "dump" is an instruction. Not a way of life.

(Or, when you're ready for IEEE S-100, will your computer be ready for you?)

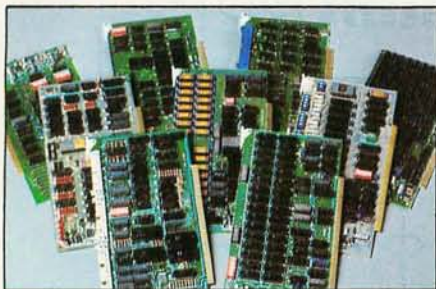

We're about to be gadflies again.

While everyone's been busy trying to convince you that large buses housed in strong metal boxes will guarantee versatility and ward off obsolescence, we've been busy with something better. Solving the *real* problem with the first line of computer products built from the ground up to conform to the new IEEE S-100 Bus Standard. Offering you extra versatility in 8-bit applications today. And a full 16 bits tomorrow.

We call our new line Series II™. And even if you don't need the full 24-bit address for up to 16 megabytes (!) of memory right now, they're something to think about. Because of all the perform-

ance, flexibility and economy they offer. Whether you're looking at a new mainframe, expanding your present one or upgrading your system with an eye to the future. (Series II boards are compatible with most existing S-100 systems and all IEEE S-100 Standard cards as other manufacturers get around to building them.)

Consider some of the features: Reliable operation to 4MHz and beyond. Full compatibility with 8- and 16-bit CPUs, peripherals and other devices. Eight levels of prioritized interrupts. Up to 16 individually-addressable DMA devices, with IEEE Standard overlapped operation. User-selectable functions addressed by DIP-switch or jumpers, eliminating soldering. And that's just for openers.

The best part is that all this heady stuff is available now! In our advanced processor—a full IEEE Bus Master featuring Memory Map™ addressing to a full megabyte. Our fast, flexible 16K Static RAM and 64K Dynamic RAM boards. An incredibly versatile and

economical 2-serial, 4-parallel Multiple I/O board. 8-bit A/D-D/A converter. Our Double-Density High-Speed Disk Controller. And what is undoubtedly the most flexible front panel in the business. Everything you need for a complete IEEE S-100 system. Available separately, or all together in our new DPS-1 Mainframe!

Whatever your needs, why dump your money into obsolete products labelled "IEEE timing compatible" or other words people use to make up for a lack of product. See the future now, at your Intersystems dealer or call/write for our new catalog. We'll tell you all about Series II and the new IEEE S-100 Bus we helped pioneer. Because it doesn't make sense to buy yesterday's products when tomorrow's are already here.

Intersystems™

Ithaca Intersystems Inc.,
1650 Hanshaw Road/P.O. Box 91,
Ithaca, NY 14850
607-257-0190/TWX: 510 255 4346

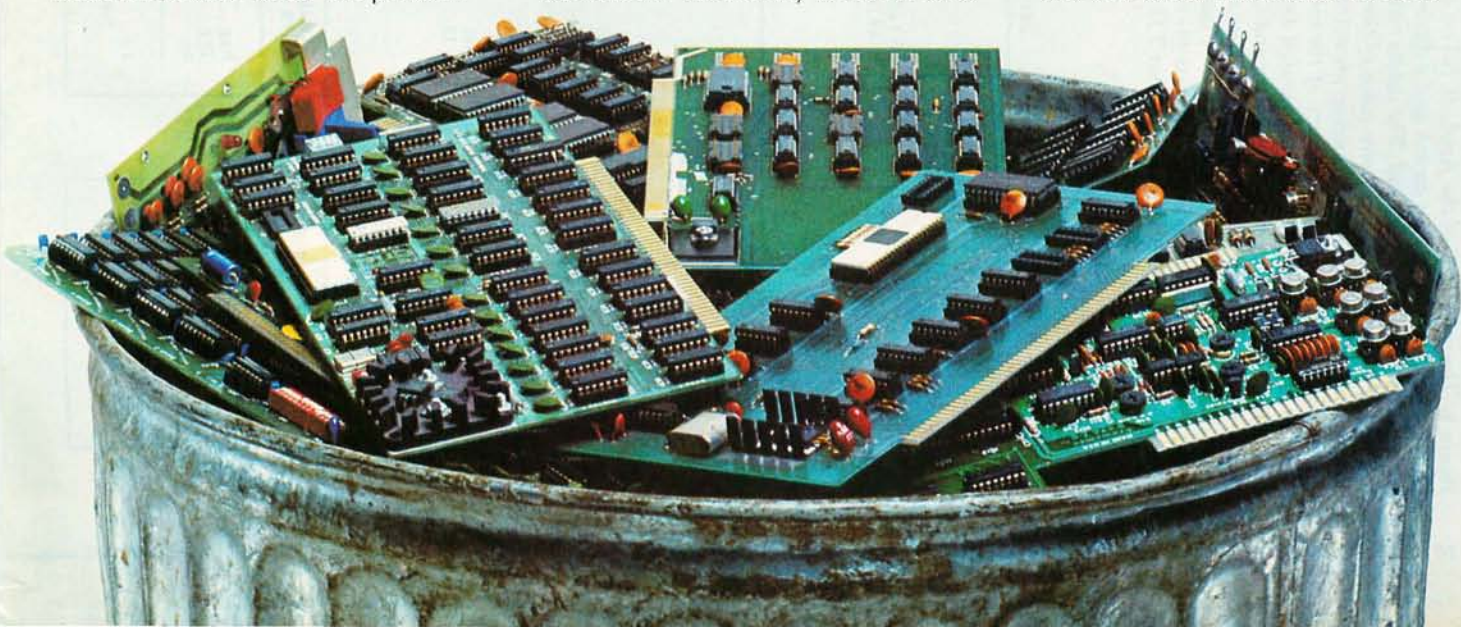

flip state. But at random times when operating the motor drive, the ANO output bit would refuse to stay in the state defined by my program. So, I then tried eliminating the relay entirely and using both output transistors of the 75450 in parallel.

The random state changes remained. The lack of a 100 MHz storage scope prevented me from seeing what had to be there: short (order of magnitude: nanoseconds) high voltage, inductive transients occurring during the time when the LS Schottky TTL latch in the Apple was having its state redefined by the program. After a trip to a Radio Shack store to buy two transistors and two packages of random assorted opto-isolators, the present circuit resulted.

The opto-isolator darlington phototransistor and transistor Q1 provide drive to an output transistor Q2. If all of the transistor collectors are wired to a common supply provided by the "black" lead of the MC-1 cable, then the circuit will latch into the "shutter open" state with transistor Q2 conducting between emitter and collector. Thus a separate power supply provided by a 9 V transistor radio battery is required for the opto-isolator's phototransistor and Q1. The 10 K ohm resistor limits current from the

Figure 1: The schematic of the Apple II/Nikon interface. The two transistors (Q1 and Q2) and diode D1 simulate a switch and a diode found inside the original Nikon MD-2 motor drive shutter-control head. The colors noted at the right in this figure correspond to the colors found in the four-wire cable of the Nikon MC-1 remote shutter extension cable. An opto-isolator with Darlington phototransistor was required in order to isolate the Apple II from the noisy transients of the motor drive.

Before this final optically isolated version was devised after much frustration (and productive suggestions from Steve Ciarcia and Chris Bancroft), three different versions were tried in which switching transients propagated back to the Apple II via a common ground. The first unsuccessful version simply had a 7404 gate driving a reed relay. Then a 75450 peripheral driver was tried because the surplus relay proved to require a higher voltage (12 V) than the 5 V available from TTL. The peripheral driver made the relay

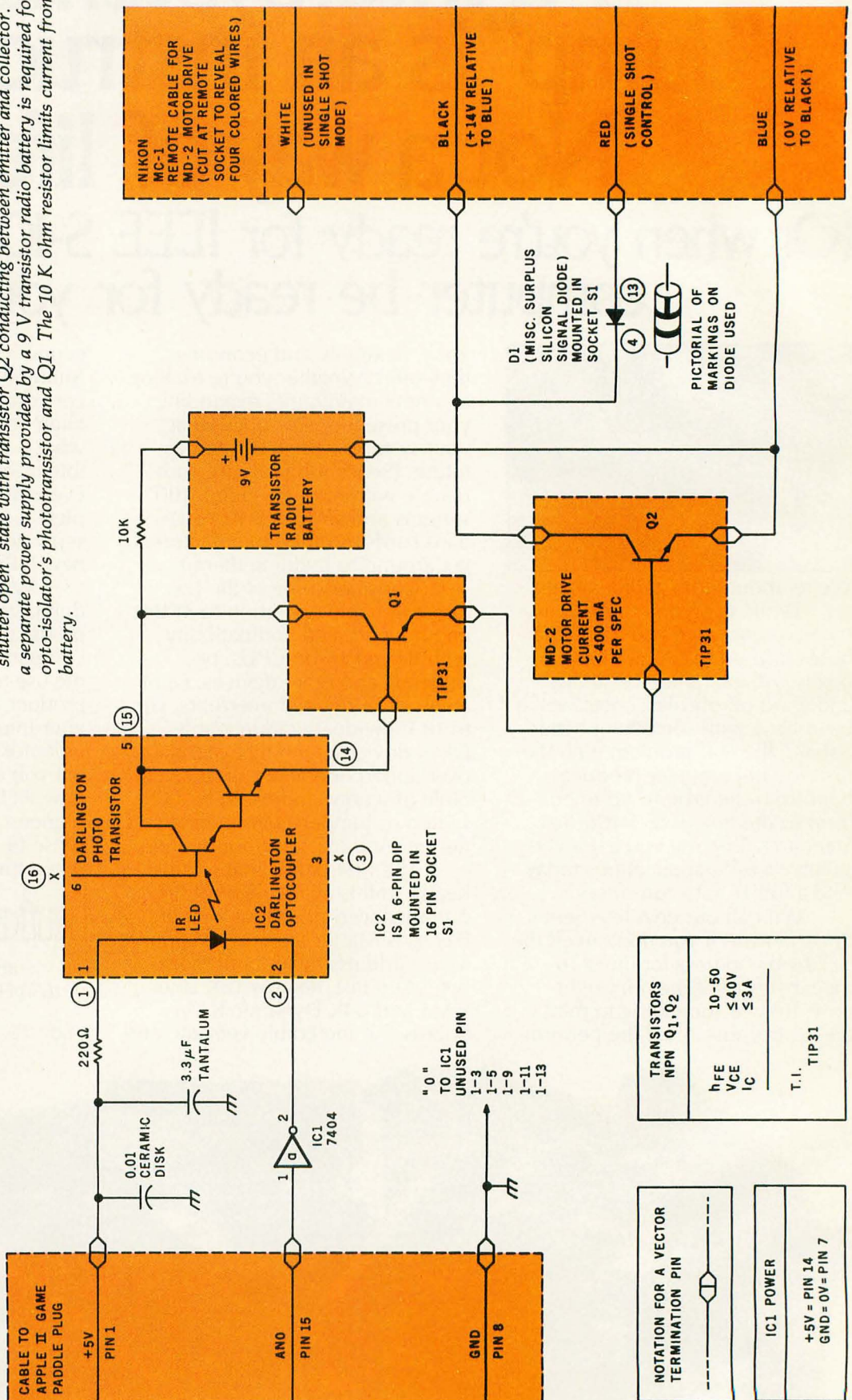

NOTATION FOR A VECTOR TERMINATION PIN	TRANSISTORS NPN Q1, Q2
IC1 POWER	VCE ≤40V
	IC ≤3A
+5V = PIN 14 GND = 0V = PIN 7	

New from SSM.



80 Character Video

With 80 characters per line our VB3 is the perfect video interface for word processing. It produces a standard 80x24 display of upper and lower case characters or as much as 80x51 for a full page of text. The matrix for graphic display goes up to 160x204. And with optional EPROM, as many as 256 user programmed characters or symbols can be produced.

VB3 is memory mapped for rapid screen updating. But it occupies memory only when activated. So one or more VB3s can be located at the same address with a full 65K of memory still available to the user.

It generates both U.S. and European TV rates and meets the new IEEE S-100 standard. Other features include keyboard input, black on white or white on black, one level of grey, underline, strike thru, blinking char., blank-out char., and programmable cursor. Software includes a CP/M compatible driver and a powerful terminal simulator.

VB3 is available in several configurations. Retail prices start at \$375 kit, \$440 assembled.

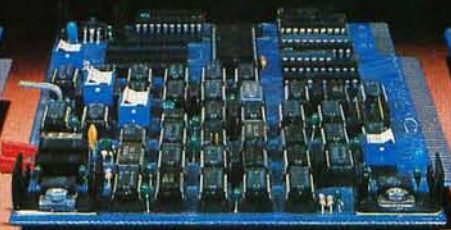

Z-80 CPU

We spent over a year designing the CB2 to assure that it will be the most fully S-100 compatible Z-80 CPU on the market.

It operates at 2MHZ or 4MHZ by DIP switch selection and includes two sockets for 2716/2732 EPROMs or TMS 4016 2K RAMs. Memory sockets can be disabled. Separate run/stop and single step switches allow system evaluation without the benefit of a front panel.

CB2 also features an MWRITE signal, firmware vector jump, and an output port to control 8 extended address lines (allowing use of more than 65K of memory). Jumper options generate the new IEEE S-100 signals to insure future S-100 compatibility.

Retail price—\$210 kit, \$275, assembled.

Our line. CPU, Video, I/O, RAM, EPROM, EPROM Programmer, Music, Prototyping, Terminator, Extender, and Mother boards. Available assembled or as kits.



8080 CPU

Our new CBIA is identical to our popular CB1 with the exception that the on-board RAM has been increased from 256 bytes to a full 1K.

It also features an optional 2K of 2708 EPROMs, power-on/reset vector jump, MWRITE, parallel input port with status and DIP switch addressing.

Retail price—\$159 kit, \$219 assembled.



2116 Walsh Avenue
Santa Clara, CA 95050 (408) 246-2707

Send for our free brochure and find out why SSM has become the favorite of discerning Hobbyists and OEMs.



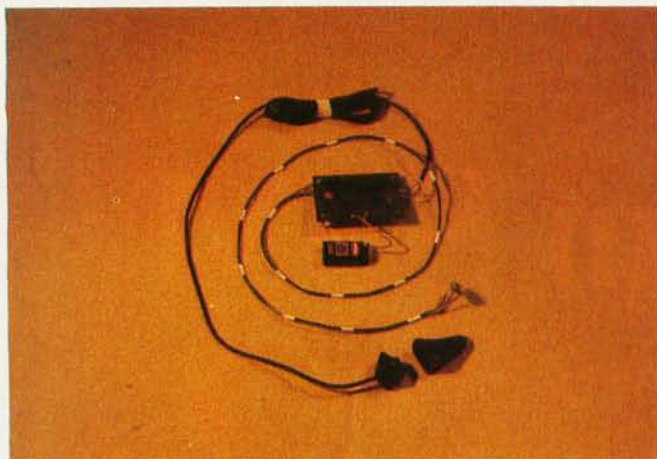

Photo 3: The Apple II/Nikon interface. The interface of figure 1 was wired on a framework of "P" pattern Vector perforated board. Vector terminal pins were used to provide anchorage for the Apple II cable (left edge), the cable from the Nikon MC-1 shutter extension (right edge), the connector for a 9 V transistor radio battery (bottom edge), and mountings for the two NPN transistors. Wiring was done using number 20 guage copper wire for most connections; wire-wrap connections were used for one or two signal buses.

Text continued from page 8:

The model I am using for exposure control is a table-driven one, with two tables of the data type "an-exposure-detail." The table "ten-shot-grouping" is initialized (in procedure "initialize," naturally) with a set of ten exposures bracketing a range from 2 milliseconds to about 4 seconds. The second table "transient-shots" is used to specify the exposures that will be taken during the transient diamond ring events at the beginning and the end of the eclipse.

The exposure control details are provided by two numbers in my model: the number of milliseconds devoted to the open camera shutter state, and the number of milliseconds of waiting time which will be used to separate the shot from the next shot. This waiting time is initialized to an "overhead-duration" figure set by a Pascal constant of that name. The present value of "overhead-duration" is set at 200 milliseconds, corresponding to the motor drive's maximum speed of 5 frames per second. This initial value of the time required for each frame is used for the first pass through the procedure "sum-up-eclipse" in order to calculate the minimum time needed for all the exposures in the total phase.

The procedure "normalize-timing" is the main portion of the simulation program as it stands in listing 1. After some initialization dialog in listing 2, the procedure "alloc-exposures" is used to assign an equal number of exposures to each diamond ring sequence (second contact and third contact) given the number of exposures during totality and the total number of exposures available in the bulk film cassette.

Then the procedure "preliminary-allocation" is used to total up the time requirements of the diamond ring exposures, totality exposures, and an arbitrary amount of slack time entered to allow a hand-coordinated cuing of the third contact diamond ring sequence. The margin

Text continued on page 102

Listing 1: A Pascal eclipse interval-allocation program. This listing contains the first cut at a Pascal camera-control program for the 1980 solar eclipse. The program's name is "eclipse-monitor-simulation" in order to emphasize that the entire process is a conceptual simulation of an actual detailed sequence of events. At this stage in the design, most of the model details have been selected in order to produce a detailed time line specified by tables. The input parameters to the program are the number of exposures, the number of exposures during totality, the time expected for totality at the site of observation, and the time to be reserved at the end of totality for manual cuing of the second diamond ring/Baily's beads (so-called third contact) exposure sequence. Listings 2 and 3 were made photographically from the terminal during a run of the program. The program as shown here has the time allocation portion completed, with the details of the actual time line simulation represented by dummy procedures, which were written in late December 1979.

```
( ) NOTES ABOUT THE DESIGN PROCESS )
( ) Step 1: High Level Description - begun November 22, 1979 )
( ) This is a first cut at a program to simulate the eclipse )
( ) photography process, and define some of the necessary global )
( ) data of the problem. )
( ) COMPLETED 11/24/79 )
( )
( ) Step 2: Fill in allocation details - )
( ) Achieve a complete allocation of the eclipse camera con- )
( ) trol function as evidenced by calculation of a detailed time )
( ) line for the eclipse event given various conditions: )
( ) Given: )
( ) n = number of totality exposures )
( ) m = number of diamond rings exposures )
( ) t = totality time )
( ) s = slack in allocated totality time )
( ) Then let us seek the followings... )
( ) * d2 = diamond rings time at 2nd contact )
( ) * d3 = diamond rings time at 3rd contact )
( ) * z = extra slack (one half of diamond rings total) )
( ) * p = anticipation time (half first diamond rings) )
( ) * A = required time for exposures during totality )
( ) * a = allocated totality time for exposures )
( ) * x = margin per frame in totality )
( ) Theorems: )
( ) d2+d3 derived from table of diamond rings frames )
( ) A derived from table of totality frames )
( ) z = (d2 + d3)/2 )
( ) p = d2 / 2 )
( ) a = t - s - z )
( ) x = (a - A) / n )
( )
( ) PROCEDURES Detailed Here Are... )
( ) initialize )
( ) normalize )
( ) COMPLETED 12/16/79 )
( )
( ) Step 3: Fill in the simulated details... )
( ) Create a program which uses the results of step 3 to )
( ) go through a detailed time line of the experiment on paper )
( ) (or terminal screen). Each event (shutter transition )
( ) open-->close or close-->open will be marked by a report of )
( ) its nature and time of execution relative to <start> signal )
( )
( ) PROCEDURES Detailed Here Are... )
( ) wait_cue )
( ) diamond_rings_burst )
( ) totality )
( )
( ) Step 4: Adapt to real time control - )
( ) Put in augmentations of the software to actually demon- )
( ) strate operation with the Nikon F2A camera via a relay )
( ) plugged into the Apple II Game Paddle Socket )
( ) THIS IS THE FINAL FORM OF THE PROGRAM TO BE USED IN THE )
( ) FIELD CONTROLLING THE EXPERIMENT... )
( ) Necessary step: determines a method of measuring time )
( ) intervals from the CPU clock which is consistent with UCSD )
( ) Pascal. Possibly use assembly language subroutine. )
( )
```

PROGRAM eclipse_monitor_simulation;

```
CONST
  overhead_duration = 200 (milliseconds);

TYPE
  seconds = INTEGER;
  milliseconds = INTEGER;
  absolute_time =
    RECORD
      units : seconds;
      thousandths : milliseconds;
    END;
  exposures = INTEGER;
  an_exposure_detail =
    RECORD
      duration : milliseconds;
      wait_after : milliseconds;
    END;
  string_pointer = ^STRING;

VAR
  s : STRING[128];
  crash_ahead : BOOLEAN;
```

Listing 1 continued on page 96

MORE CAPABILITIES THAN ANY OTHER PERSONAL COMPUTER UNDER \$1,000*

Compare the built-in features of the ATARI® 800™ with other leading personal computers. Whether you program it yourself or use pre-programmed cartridges or cassettes, the ATARI 800 gives you more for your money.

Run your own programs? Easy. Just plug in the 8K BASIC or optional Assembler language cartridge, and go. They're ROM based. That means more RAM for your programs.

Also included with the ATARI 800 is an internal speaker and four separate sound channels, FCC approval, a built-in RF modulator, the ATARI 410™ Program Recorder and a high speed serial I/O.

Peripherals? Add up to 48K of user installable RAM. Or up to four individually accessible floppies.

A high-speed printer. And more to come.

Graphics programs? No problem. The ATARI 800 offers 128 color variations: 16 colors in 8 luminance levels. Plus 29 keystroke graphics symbols and 8 graphics modes. All controlled from a 57 character ASCII keyboard. With upper and lower case.

Or, program it our way. There are exciting programs available and many more on the way for the ATARI 800. Business programs. Home Management programs. Entertainment. And with the 410 audio/digital recorder, you can add Atari's unique Talk & Teach™ Educational System cassettes.

Your way or our way, you'll find that the ATARI 800 is probably the most powerful computer that \$999.99* can buy.

And with that power, you get dependability. Dependability built into Atari's custom designed and fully-tested LSI circuitry and lower component count, (less components, less chance for failure).

But if anything ever does go wrong, you'll find a complete network of computer-connected Atari service facilities waiting for you throughout the country.

Make your own comparison. Hands on. Anywhere computers are sold. Or, send for a free chart that compares the features of the ATARI 800 to other leading fully-programmable computers.

*Suggested retail price \$999.99, includes computer console, program recorder and BASIC language cartridge.

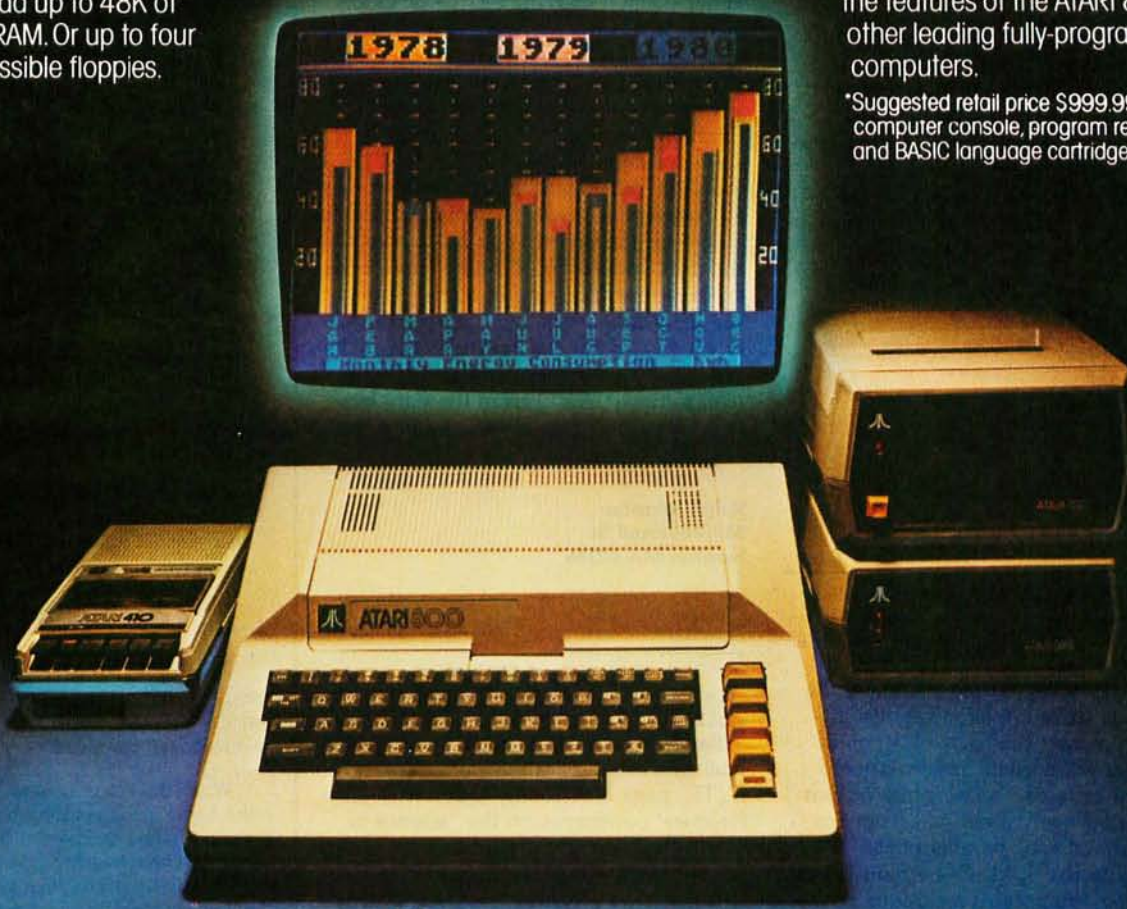

ATARI®
PERSONAL COMPUTER SYSTEMS

1265 Borregas Ave., Dept. C, Sunnyvale, California 94086. Call toll-free 800-538-8547
(In California 800-672-1404) for the name of your nearest Atari retailer.

Letters

Needed: Software and/or Computers in Rhodesia

In the Faculty of Engineering at the University of Rhodesia, we have a critical shortage of computing facilities, and we do not have the foreign currency or the monies to purchase even simple systems like the Apple II or Cromemco. We are therefore obliged to build our own microcomputer systems. Unfortunately, we do not have the necessary expertise at the University or in the country to write the necessary BASIC interpreters, assemblers, and editors to make our systems useful or suitable for teaching purposes. I would appreciate it if one of your readers could put me on to someone who could possibly supply the BASIC interpreter and/or compiler; assembler, with loader if required; and a text editor for the Intel 8080 or 8085 microprocessors.

I have been through BYTE magazine, but no one seems to offer the above software in the form which we could adapt for our own homebrew computers, and, therefore, we would appreciate it if one of your readers could advise us of anyone who may be able to sell or donate such software to enable us to offer a more effective computer teaching facility.

W B Green
Projects Engineer
POB M P 167
Mount Pleasant
Salisbury
RHODESIA

The Bare Necessities

I enjoyed the article "Budget Building on a Bare Board" by Dan S Parker (October 1979 BYTE, page 206). As he points out, there are large savings in building up only the parts of a circuit board that are needed. For instance, I have built only one serial input/output (I/O) port (for my Teletype) from the two serial and four parallel ports available on the SSM IO-4 circuit board. I have also applied this technique to a Z80 processor board, an 8 K-byte memory board, an erasable programmable-read-only memory board, and a cassette interface board.

Mr Parker's article did not go on to

describe what you can do using these partially built-up boards. I am using the Integrand Research mainframe box, the SSM Monitor VI.0 (in the erasable programmable-read-only memory), and Palo Alto Tiny BASIC (Extended), which I typed into my system from the May 1976 and February 1977 issues of *Dr Dobb's Journal of Computer Calisthenics and Orthodontia*. This BASIC interpreter fits in only 2 K bytes of memory and is amazingly powerful.

I am writing a program to store a mailing list of 1000 names and addresses in main memory. The program should be able to add, delete, alphabetize, sort by ZIP code, and compress the list to free space from deleted entries. Just how far can one go without a floppy disk drive?

Readers of BYTE can obtain copies of the software I have written from me for either a small copying charge or in exchange for other software. I use the Intel hexadecimal checksum format on either paper tape or Kansas City cassette tape.

I have found that the Jade Serial/Parallel/Cassette I/O board is not software-compatible with the SSM monitor, but it can be made so through a process that involves cutting conductor etches on the board. You must reverse the port address bits 0 and 7, invert the transmitter-buffer-empty signal, invert the read-data-available signal and move to bit 7, and cut the control bits for the universal asynchronous receiver/transmitter (UART) from the data bus. Following this, you rewire these in the desired format.

Ralph Johnston
35 Groveland St
Newton MA 02166

Biological Rhythms and Biased Data

Regarding the editorial ". . . Pseudoscience Done . . ." (November 1979 BYTE, page 6): I totally agree with Carl Helmers' comments on the "science of biorhythms." At many times I have also been curious about the apparent cyclical nature of my physical and mental processes — such as, a few occasional nights of especially weird dreams; or several days of running slower and more painfully than usual (I run for exercise); days of great mental energy filled with

A growing line of tools to expand the Apple.

7400A Programmable Interrupt Timer Module. Time events in four operating modes — continuous, single shot, frequency comparison, and pulse width comparison. Includes three 16-bit interval timers, plus flexible patch area for external interface. Programmable interrupts, on-board ROM, and much more.

7720A Parallel Interface. Two bi-directional 8-bit I/O ports will connect your Apple to a variety of parallel devices, including printers, paper tape equipment, current relays, external on/off devices. Full featured, programmable interrupts, supports DMA daisy chaining.

7811B Arithmetic Processor. Interfaces with Applesoft, so you just plug in and run. Based on the AM 9511 device, provides full 16/32-bit arithmetic, floating point, trigonometric, logarithmic, exponential functions. Programmed I/O data transfer, much, much more. (Not currently compatible with Apple II Plus — check with your dealer.)

7710A Asynchronous Serial Interface. Conforming to RS-232-C A thru E 1978 standard, this card will drive a variety of serial devices such as CRT terminals, printers, paper tape devices, or communicate with any standard RS-232 device, including other computers. Full hand-shaking, and fully compatible with Apple PASCAL!

7470A 3% BCD A/D Converter. Converts a DC voltage to a BCD number for computerized monitoring and analysis. Typical inputs include DC inputs from temperature or pressure transducers. Single channel A/D, 400 ms per conversion.

7490A GPIB IEEE 488 Interface. A true implementation of the IEEE 488 standard — the standard protocol for instrumentation and test devices. Control and monitor test instruments such as digital voltmeters, plotters, function generators, or any other device using the IEEE 488.

7114A PROM Module. Permits the addition to or replacement of Apple II firmware without removing the Apple II ROMs. Available with on-board enable/disable toggle switch.

7500 A Wire Wrap Board. For prototyping your own designs.

7510A Solder Board.

7590A Extender Board.

7016A 16K Dynamic Memory Add-On.

Watch this space for new CCS products for the Apple. We've got some real surprises in the works. To find out more about the CCS product line, visit your local computer retailer. The CCS product line is available at over 250 locations nationally, including most that carry the Apple. Or circle the reader service number on this ad.

Apple II, Apple II Plus, and Applesoft are trademarks of the Apple Corporation.

CCS makes the difference.

We see the Apple a little differently.



We see it as a good way to get things done.

Apple has built a great computer. We at CCS have built a great line of peripherals and components to expand the Apple. To do almost anything you want to get done with a computer.

If you want to do business with an Apple, we've got tools to connect the Apple to standard business printers and terminals. Or to modems, for communications over telephone lines, with other computers, even with other Apples.

If you want to apply your Apple to engineering, scientific, or graphic projects, we've got tools for high-powered,

high-speed math functions, and fast, high resolution graphics. And tools to connect the Apple to lab test equipment like function generators or plotters.

And we have tools to connect the Apple to the outside world, including A/D converters and interval timers with external interface.

We make components for the S-100 bus, the PET, and the TRS-80, too. We built our products to deliver hard-nosed value to the OEM, and to the inventor who knows the best, at prices that are unbeaten.

To find out how much computer your Apple II can be, see things our way. Because for serious users with serious uses for the Apple, we've got the tools.



California Computer Systems

250 Caribbean Sunnyvale, CA 94086 (408) 734-5811

UP TO 2400 MEGABYTES OF HARD DISK CONTROL FOR THE S-100 BUS

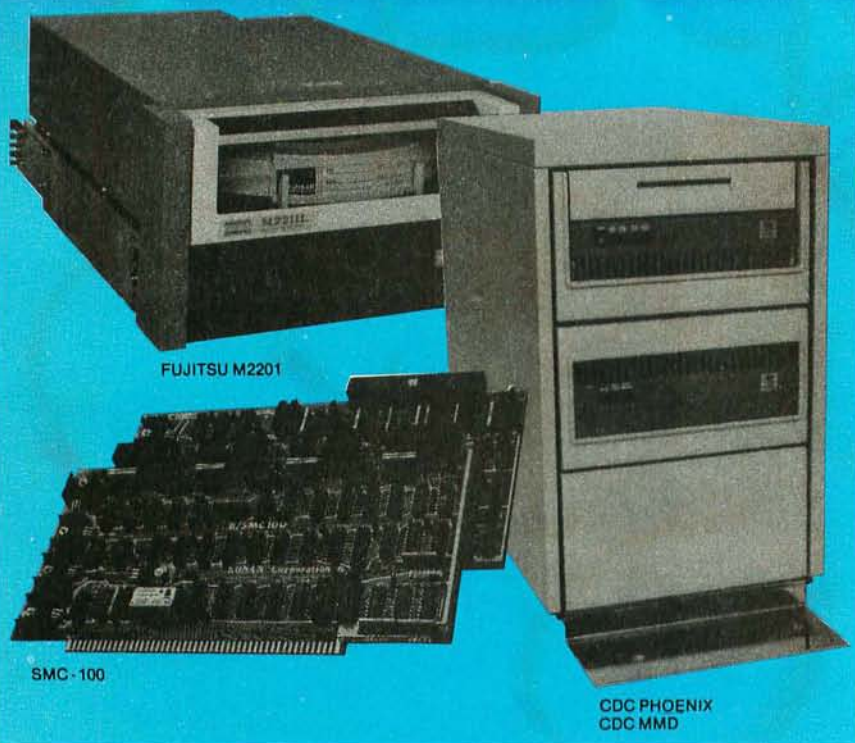

FUJITSU M2201

SMC-100

CDC PHOENIX
CDC MMD

Konan's SMC-100 is versatile, fast, cost efficient. It's the disk controller that brings S-100 bus micro computers together with large capacity hard disk drives.

Versatile

Interfaces S-100 bus micro computers with all fixed or removable media disk drives with storage module (SMD) interfaces. Each Konan SMC-100 will control up to 4 drives ranging from 8 to 600 megabytes per drive, including most "Winchester" type drives. Up to 2400 megabytes of hard disk per controller! And you can take your pick of hard disk drives: Kennedy, Control Data, Fujitsu, Calcomp, Microdata, Memorex, and Ampex, for example.

Fast

SMC-100 transfers data at fast, 6 to 10 megahertz rates, with full onboard sector buffering and sector interleaving, and a DMA that's faster than other popular S-100 DMA controllers.

Cost efficient

SMC-100 is priced right to keep your micro computer system micro-priced. It takes advantage of low-cost-per-megabyte disk drive technology to make the typical cost less than \$80 per megabyte. The OEM/Dealer single quantity price is only \$1650, with driver ROM option. Excellent quantity discounts are available.

SMC-100 availability:

Off the shelf to 30 days in small quantities. (Complete subsystems are on hand for immediated delivery.)

Konan has the answers. Talk to them today. Call direct on Konan's order number: 602-269-2649. Or write to Konan Corporation, 1448 N. 27th Avenue, Phoenix, Arizona 85009.

KONAN™

1448 N. 27th Avenue • Phoenix, Arizona 85009 • 602-269-2649

great plans, etc. . . . But each time I think about "taking data" on these phenomena, I realize the strong possibility that such data would be biased by my expecting that cycles do exist. We know how powerful our subconscious minds are. I feel my subconscious mind is easily capable of keeping track of days and thus creating (or at least influencing) the very cyclical data I am searching for.

If this is the case, perhaps the data gathering would only be valid for someone who had never heard of biorhythms. Or, maybe the human-behavior guys can figure a way around the bias.

Anyway, thanks for a good magazine.

Sid G Knox
4621 South G St
Oxnard CA 93030

Correspondence Regarding "Curve Fitting with Your Microcomputer"

"Curve Fitting with Your Microcomputer" (October 1979 BYTE, page 150) has resulted in interesting mail correspondence, some of which has enough general value to merit discussion in BYTE.

Several readers have requested information on reference books which relate to least-squares curve fitting in more than one dimension. I have yet to find a book which has a good, balanced discussion on this subject. Perhaps a reader has. One useful book is *Applied Regression Analysis*, by Norman Draper and Harry Smith (John Wiley and Sons, 1966). Another more detailed and complicated discussion appears in *Computational Geometry for Design and Manufacture*, by I D Faux and M J Pratt (John Wiley and Sons, 1979).

Dr Titus (of Tychon) has informed me of a convolution technique for least-squares smoothing of equally spaced data. The mechanics of the method are very similar to those involved in non-recursive digital filters, and reminiscent of Akima's approximation to the cubic spline fit. The reference Dr Titus supplied was "Smoothing and Differentiation of Data by Simplified Least-Squares Procedures," by A Savitsky and M J E Golay (*Analytical Chemistry*, volume 36, number 8, July 1964).

As a final note, it has been noted that program line 800 in listing 1 has an error in it. The correct statement is $S = S/(I-3)$, instead of $S = S/(I-1)$. This does not affect the curve fit or relative comparisons, but influences the printed value of the standard deviation by several percent.

F R Ruckdeschel
Xerox Corp
Xerox Square
Rochester NY 14644 ■



Apple lets you get personal with Pascal.

There's only one logical way to find out what a person wants in a personal computer.

Ask the person who'll be using one.

At Apple, we've been very successful at identifying just what people look for in computers. And then providing them with it.

In spades.

For serious enthusiasts, this means making available sophisticated innovations that are often conspicuously absent from other personal computers.

Like Pascal.

Apple II is one of the few personal computers that has it. And when you turn this page and feast your eyes on the many advantages this

high level, general-purpose language has to offer, you'll see why that's very good news indeed.



When you've got it, flaunt it.

If you'd like to let the world know who speaks Pascal, here's how:

Follow the dotted line and cut out the transfer image above.

Preheat iron (dry-wool setting) for 3 minutes. Slip garment on ironing board over scrap material. Remove wrinkles. Position transfer face down and pin edges to ironing board cover. Iron transfer slowly for one minute. If paper browns, iron is too hot. Let transfer cool for one minute, then unpin and slowly pull transfer straight up. Results are best when t-shirt is at least 50% polyester.

Pascal by the package.

Our high-level, full feature Language System consists of a plug-in 16K RAM language card, five diskettes containing Pascal as well as Integer BASIC and Applesoft extended BASIC, plus seven manuals documenting the three languages.

The beauty of this Language System is that it speeds up execution and helps cut unwieldy software development jobs down to size. Also, because the languages are on diskette, loaded into RAM, you can quickly and economically take advantage of upgrades and new languages as they're introduced.

Apple's Pascal language takes full advantage of Apple high resolution and color graphics, analog input and sound generation capabilities. It turns the Apple into the lowest priced, highest powered Pascal system on the market. With Pascal, programs can be written, debugged and executed in just one-third the time required for equivalent BASIC programs. With just one-third the memory.

On top of that, Pascal is easy to understand, elegant and able to handle advanced applications. It allows one programmer to pick up where another left off with minimal chance of foul up.

Because Apple uses UCSD Pascal,TM you get a complete software system: Editor, Assembler, Compiler, and File Handler. And because we adhere to the standard, your programs run on any UCSD Pascal system with minimum conversion. Which is really something an enthusiast can get enthusiastic about.

To be more specific.

The Apple II's specs are tempting enough without the Language System and Pascal. With them, they're downright irresistible.

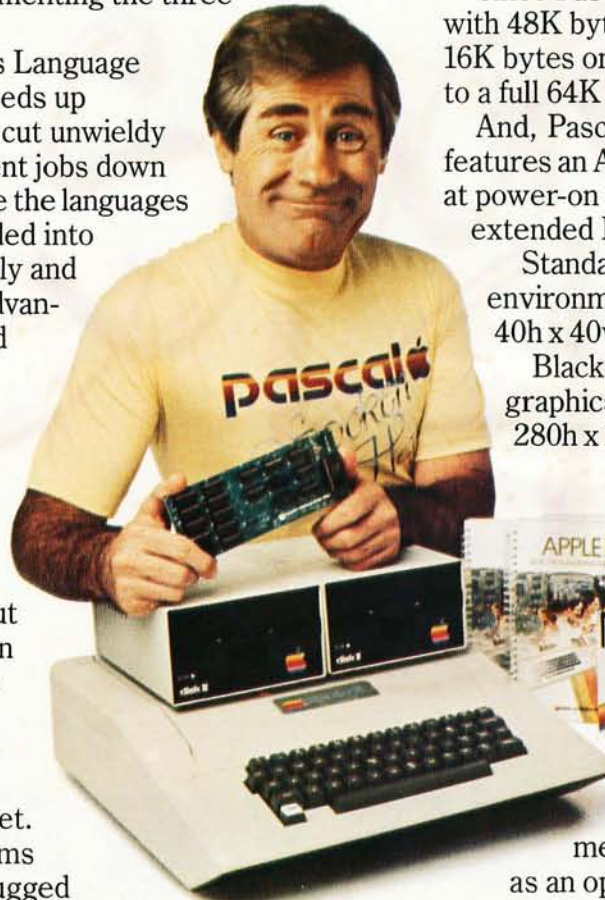

The text screen, a 24x40-line window, can display an entire 80-column Pascal line, thanks to Apple's unique horizontal scrolling feature.

Characters are normal, inverse or flashing, 5x7, upper case. Full cursor control is standard.

Since Pascal runs on an Apple computer with 48K bytes of on-board RAM, the additional 16K bytes on the language card bring the total to a full 64K bytes.

And, Pascal runs on the new Apple II Plus. It features an Auto-Start ROM that boots the Disk II at power-on for turn-key operation. Applesoft extended BASIC is resident in ROM.

Standard color graphics (in the BASIC environment) offer 40h x 48v resolution, or 40h x 40v with 4 lines text, in fifteen colors.

Black/white high resolution, bit-mapped graphics display 8K bytes of memory as a 280h x 192v image (140h x 192v in six colors).

Fully buffered peripheral connectors provide access to all system buses, for complete interface freedom.

And finally, since it weighs a mere 11 lbs. and has its own travel case, as an option, not only is it easy to get carried away with an Apple, it's easy to carry one away.

We've got your numbers.

800-538-9696. (In California, 800-662-9238.) Or write us at 10260 Bandle Drive, Cupertino, California 95014. When you contact us, we'll give you the name, address and telephone number of the Apple computer dealer nearest you.

If you'd like more information on the advantages of owning an Apple personal computer, he can fill you in. Personally.

apple computer 

Ease into 16-Bit Computing: Get 16-Bit Performance from an 8-Bit Computer

Steve Ciarcia
POB 582
Glastonbury CT 06033

Stopping for coffee at the local doughnut shop has become a morning ritual. I am quite capable of making coffee at home, but I am not what you would call a "morning person." Even though I have culinary talents that include the preparation of eggs Benedict and strawberry crepes, it had better be evening when you request them around our house.

This morning started out like any other. I pulled my car into the doughnut shop's parking lot only after carefully examining all the potential hazards. I carefully avoided the broken glass, the beat-up 1962 Chevy and the large black van with a "Tax the Rich!" bumper sticker.

After entering the shop, I sat down and spread my reading material, the latest issue of BYTE, on the counter. As my coffee and bran muffin were delivered, I could not help but overhear the conversation of two other people at the counter.

"Dave, have you been reading any of the magazines lately? It looks like everyone is going 16-bit crazy."

"I've read a lot of descriptive articles, but I suppose it'll take a while before we see any real hardware."

"Actually, I'm a little hesitant to just jump on the bandwagon. My 8085 works just fine."

"I know what you mean, Ed. The Z80 system I built from scratch is still

cranking along. I'd like to do something with the 16-bit chips, but I sure don't want to throw out my 8-bit system."

"What about building a small system to experiment with? Didn't I see an article a few months ago on a single-board 8086?"

"Yeah, I remember. It was in BYTE. Wasn't it written by that guy who lives around here someplace, in his cellar or something?"

Upon hearing that last statement, I nearly choked on my muffin. I thought it would be prudent to remain anonymous until I learned whether or not they enjoyed the article. I carefully closed the magazine and placed it face down on the counter.

.....

One way to ease yourself into the world of 16-bit computers is with the Intel 8088. This micro-processor is an 8086 on the inside with an 8-bit data bus on the outside.

.....

"Maybe, but anyway, the article wasn't too bad," said Ed. I'm sure they didn't hear the sign of relief from across the counter. Then he continued, "But it just seemed like a

larger computer than I have time to build. It's obviously oriented toward guys who don't have any other development system. I'd prefer a minimal hardware configuration to start with. If I want large programs, I'll run a macroassembler on my 8085 system, write the object code into an EPROM, and then plug it into the test board."

"Eliminating all the keys and displays will help, but how small a computer can we end up with and still be 16-bit? You'll need 16-bit address and data buses, and what's 1 K words of memory—four chips? All the EPROMs I know are 8-bit output. That means at least two of them."

"Wait a minute," said Ed. "I didn't say I had all the answers. The minimal configuration may be twenty chips, but isn't this closer to something we could afford to experiment with?"

This was the perfect opportunity to express my point of view concerning the things that I write and consult about. "Excuse me," I said. "I couldn't help but overhear your conversation. Had you considered using an 8088?"

The two young men looked up at me, paused, and harmonized, "An 80 what?"

"I know a little about micro-processors. Have you considered using an Intel 8088?"

"Is it 16-bit?" asked Dave.

"Well, yes and no," I replied. "It uses an 8-bit data bus, but, internally it's an 8086. Essentially it's an 8-bit chip that's completely 8086-software-compatible."

Should they listen to this doughnut and coffee philosopher? "That sounds tremendous, but won't it still require quite a few chips to make an operational computer?"

I sensed that this was a good time for my exit. Staying any longer would involve my designing a computer for them on the back of a napkin. Ordinarily I probably would have stayed, but I had just completed a similar task in my latest article, so I decided to let them wait a few more weeks. I rose to leave, carefully rolling up the copy of *BYTE*, cover page inside, and stopped behind them on my way out. "My recollection is that while four chips is a possibility, a five-chip computer is quite a reality. I've even seen how a BASIC interpreter could be written to run on it. In case you're interested, the next issue of *BYTE* has an article all about it."

I excused myself to attend an

important meeting. As I opened the door I heard, "Thanks, I'll look forward to reading it." They watched me intently as I drove out. I could only speculate on their final conversation.

The 16-Bit Generation

The exciting items in microcomputing these days are the 16-bit microprocessors made by companies such as Intel (the 8086), Zilog (the Z8000) and Motorola (the M68000). All of these devices, although they differ in internal architectures, commonly claim to have compressed the power of a minicomputer within a single chip of silicon. Most notably are the 16-bit data bus and increased addressing space. A 20-bit address can directly address a megabyte of memory.

There seems to be little doubt in the minds of microcomputer-system designers that the 16-bit processors are the wave of the future. Already some major manufacturers are designing the new processors into intelligent terminals, word-processing systems, and other equipment. The day when this revolution within a

revolution will affect the personal and small-business computer marketplace is not too far away.

But if it is obvious that the 16-bit machines will be the trend of future product technology, it is equally obvious that it is relatively difficult for the designer to make a leap from the 8-bit world of the 8080, Z80, 6800 and 6502 to the emerging 16-bit world. The 16-bit instruction sets are more complex. The 8086, for instance, has a repertoire of some 133 instructions, as compared to seventy-eight for the 8080. Simply because of the larger range of memory that can be addressed and because of address segmentation, addressing of memory is more advanced. Also, the register set is more complicated, and the types of operands with which the processor can work are more extensive.

As complex as the 8086 or any other 16-bit microprocessor is from a software viewpoint, it is in the design of hardware circuits to work with the 16-bit processors where the real complexities arise. Peripheral interfaces and existing hardware systems are generally based on an 8-bit data bus. When your whole design is built to make efficient use of an 8-bit data bus, converting to a 16-bit architecture is not a simple matter of replacing the processor. This incompatibility dictates substantial design changes to take advantage of the new 16-bit microprocessor.

A Gradual Approach to 16-Bit Computing

There is an alternative to converting abruptly to 16-bit architecture. Look at photo 1 and observe the Intel 8088 microprocessor. This device uses an 8-bit data bus, so all of your present hardware system components will work with it from the standpoint of getting information between the processor and the peripheral-support devices or memory, but the 8088 features a common internal architecture and complete software compatibility with the 16-bit 8086 processor.

As a result, the 8088 provides an excellent way for designers, engineers, hobbyists, and students to ease into the world of 16-bit computing. Its 8-bit-compatible bus structure makes it the logical choice for upgrading 6800, 6502, Z80 and 8080 designs to 16-bit capability without

NEW

INCREDIBLE Computer Opponent Program only \$24.95

MONTY™ Challenges You to MONOPOLY*

MONTY™ is full of surprises. Entertains as he plays—with music and colorful visual effects. Cassette programs available for 16 K APPLE II* and 16K Level II TRS-80* microcomputers for use with your Monopoly game. MONTY™ is a shrewd operator. But he *can* be beaten. Send \$24.95 check or money order (postage paid) lowans add 3% sales tax. Remember... "MONTY™ plays Monopoly."



Ritam Corporation® P.O. Box 921, Fairfield, Iowa 52556

*Monopoly is a trademark of Parker Bros., Inc.
Apple is a trademark of Apple Computer, Inc.
TRS-80 is a trademark of Tandy Corp.

©Ritam Corporation, 1980

Name _____
Address _____
City _____ State _____ Zip _____
 APPLE TRS-80

I've finally found a personal computer I respect.

Compucolor II.

ratio available in a personal computer.

The complete system is only \$1895*. And that price includes 8K user RAM, RS-232C compatibility and random access file capabilities.

Our 8 foreground and background colors will boost your comprehension, while introducing you to an exciting new dimension in BASIC programming. The vector graphics have 16,484 individually-accessible plot blocks. And the 13" diagonal measure screen gives you 32 lines of 64 ASCII characters. You also have the flexibility that comes with 16K Extended Disk BASIC ROM.

Compucolor II offers a number of other options and accessories, like a second disk drive and expanded keyboard, as well as expandability to 32K of user RAM. Of course we also have a whole library of low-cost Sof-Disk™ programs, including an assembler and text editor.

Visit your nearest computer store for details. And while you're there, do some comparison testing. With all due respect to the others, once you see it, you'll be sold on the Compucolor II.



**Compucolor®
Corporation**

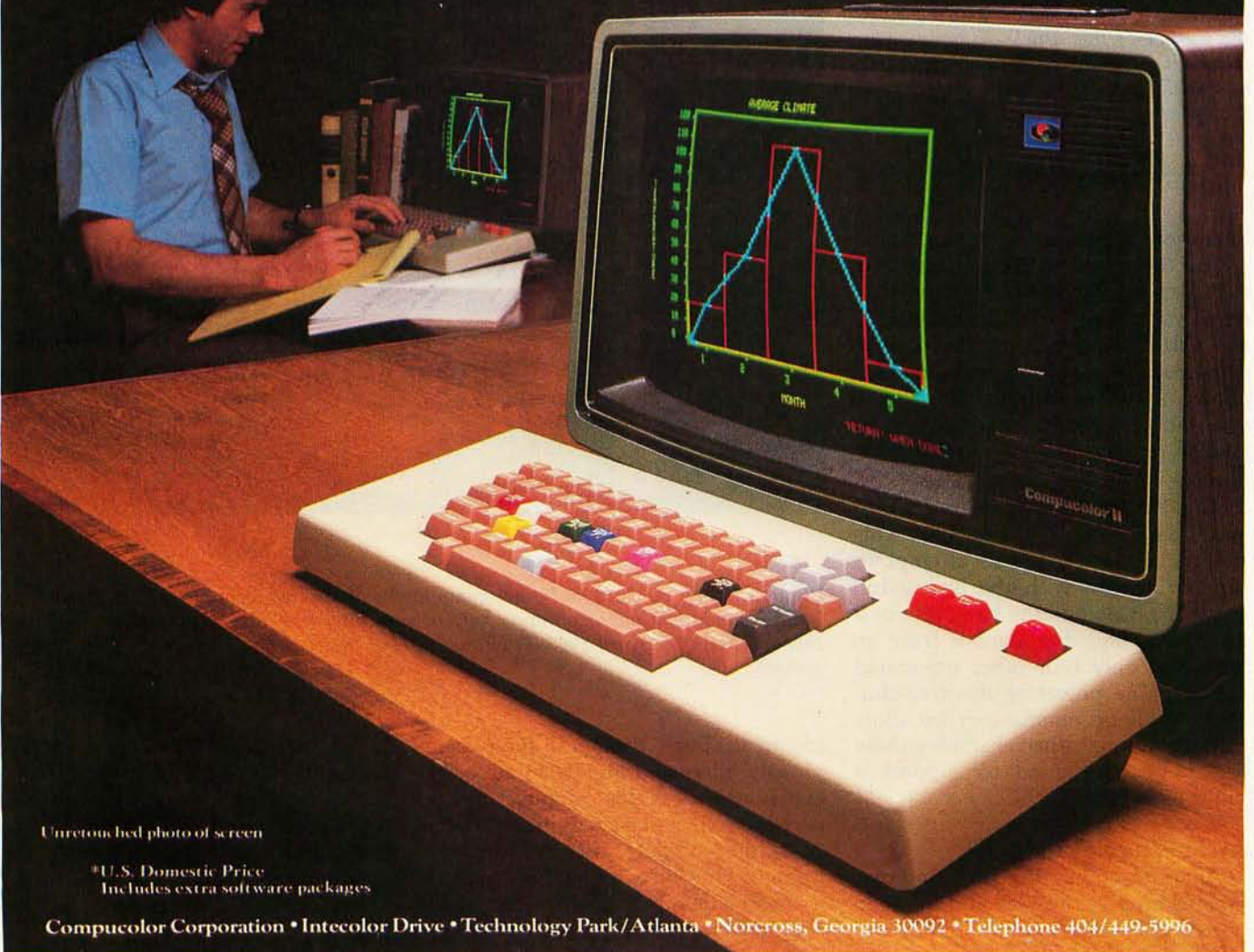

Unretouched photo of screen

*U.S. Domestic Price
Includes extra software packages

Compucolor Corporation • Intecolor Drive • Technology Park/Atlanta • Norcross, Georgia 30092 • Telephone 404/449-5996

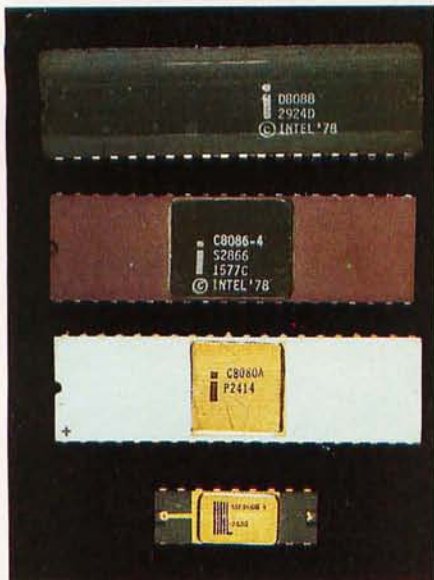

Photo 1: An exhibit of advancing microprocessor technology. Here are four integrated circuits produced by Intel Corporation. From bottom to top, we have the 8008, the first 8-bit general-purpose microprocessor; the 8080A, one of the breed of 8-bit devices that helped ignite the microcomputing boom; the 8086, the advanced 16-bit processor; and the 8088, the subject of this article—a component that contains 16-bit computing capability in a package that can communicate with the outside world through an 8-bit data bus.

alteration of existing 8-bit hardware.

The 8088 can be used in projects such as a low-cost system that employs multiplexed peripherals such as the 8155, 8755A and 8185. Or, fully expanded, it forms a system that allows a full megabyte of address space and compatibility with the 8086 family of coprocessors and multiprocessors.

This two-part article is designed to give you a glimpse of the 8088. This month in Part 1, I shall attempt to familiarize you with the instruction set of the 8088 and the hardware of a microcomputer that is made from an 8088 and only four other integrated circuits. The power of this five-chip circuit will be emphasized by illustrating, among other examples, how it can be configured to support a multi-user Tiny BASIC.

Architecture of the 8088

Anyone comparing the internal architectures of the 8088 and the 8086 processors will realize that they are

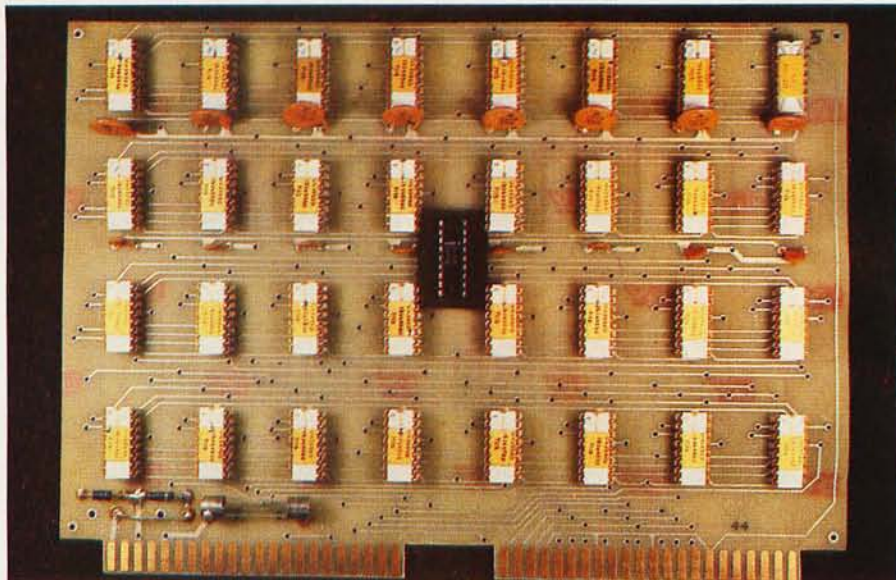

Photo 2: An exhibit of advancing memory technology. The single black integrated circuit at the center can replace the entire board of components. The center component is the Intel 8185 1 K-byte static programmable memory. The board is a 1 K-byte memory board from a Scelbi 8B microcomputer system, which used the 8008 microprocessor (circa 1975).

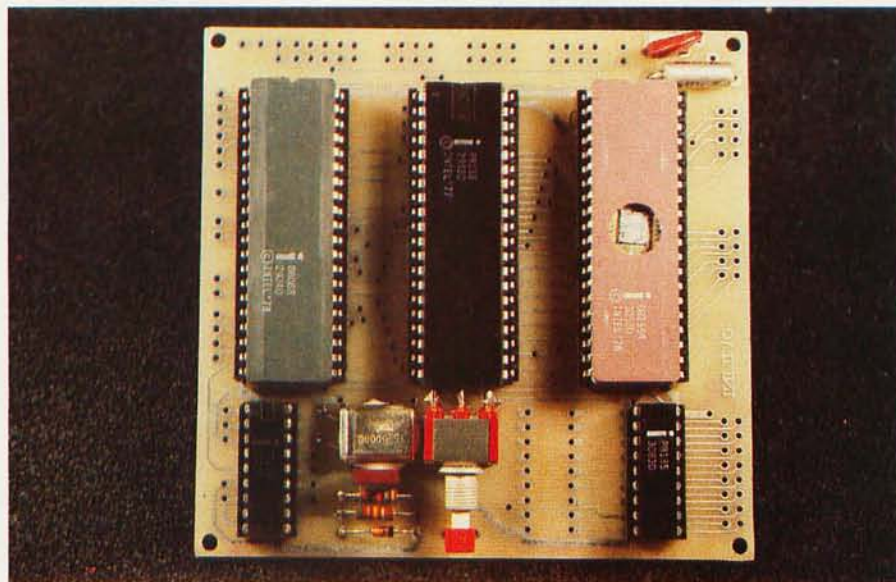

Photo 3: Using the 8088 and other components of kindred technology, it is possible to build a functional microcomputer system with only five integrated circuits. Part 2 of this article (in the April 1980 BYTE) will present more detailed information about this system.

identical. Even though I have previously discussed the 8086, a brief explanation of this architecture is necessary since the capabilities of our five-chip computer depend directly upon it. However, if you wish to read a more detailed description, you should refer to a previous Circuit

Cellar article, "The Intel 8086" (November 1979 BYTE, page 14).

A diagram of the internal structure of the 8088 is shown in figure 1. The 8088 contains two logical "units", the bus-interface unit (BIU) and the execution unit (EU), and a 4-byte instruction queue.

COMPARE SMARTS.



Reverse video
Blinking/blank fields

Upper/lower
case char.

Protected fields

Non-glare screen

Underlining

12 x 10 char. res.

Function/editing keys

Blinking cursor

Typewriter/TTY

keyboards

Numeric pad

• 9 Baud rates
(75-9600 Baud)

• Self test

• Auxiliary port

Feature-for-feature our smart CRT terminals cost less than *their* dumb ones. Much less. Compare smarts. Then compare price. You'll pick TeleVideo.

Four different models to choose from. Each with features you'd expect to pay extra for. But with TeleVideo, they're standard.

We put a lot of engineering savvy into our CRTs. Their modular design means high reliability. It also lets us build in high volume. And sell to you at low prices.

Find out how you can make your next CRT buy a smart one. Contact TeleVideo today for information.

Nationwide Field Service is available from General Electric Co., Instrumentation and Communication Equipment Service shops.



TeleVideo™

TeleVideo, Inc., 3190 Coronado Dr.
Santa Clara, California 95051
Phone (408) 727-5428



COMPARE PRICE.

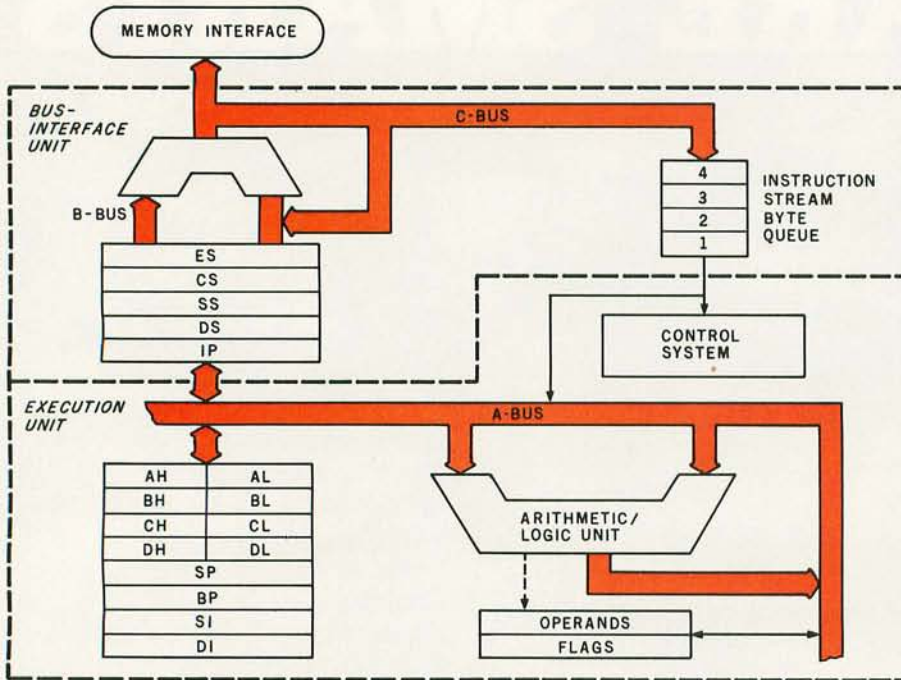

Figure 1: Diagram showing internal operational principles of the 8088 microprocessor. The 8088 (and the 8086) use a pipelined architecture that increases performance by overlapping instruction execution with memory-fetch operations. The 8088 can directly execute any 8086 software.

The *execution unit* is where the actual processing of data takes place inside the 8088. It is here that the familiar arithmetic logic unit (ALU) is located, along with the registers used to manipulate data, store intermediate results, and keep track of the stack. The execution unit accepts instructions that have been fetched by the bus-interface unit, processes the instructions, and returns operand addresses to the bus-interface unit. The EU also receives memory operands through the bus-interface unit, processes the operands, and then passes them back to the bus-interface unit for storage in memory.

The role of the *bus-interface unit* is to maximize bus-bandwidth utilization, (that is, to speed things up by making sure that the bus is used to its full capacity). The bus-interface unit carries out this assignment in two basic ways:

- by fetching instructions *before* they are needed by the execution unit, storing them in the instruction queue
- by taking care of all operand fetch and store operations, address relocation, and bus control (These actions of the bus-interface unit leave the execution unit free to concentrate on processing data and carrying out instructions.)

8088 REGISTER MODEL: (8080 REGISTERS SHADED)

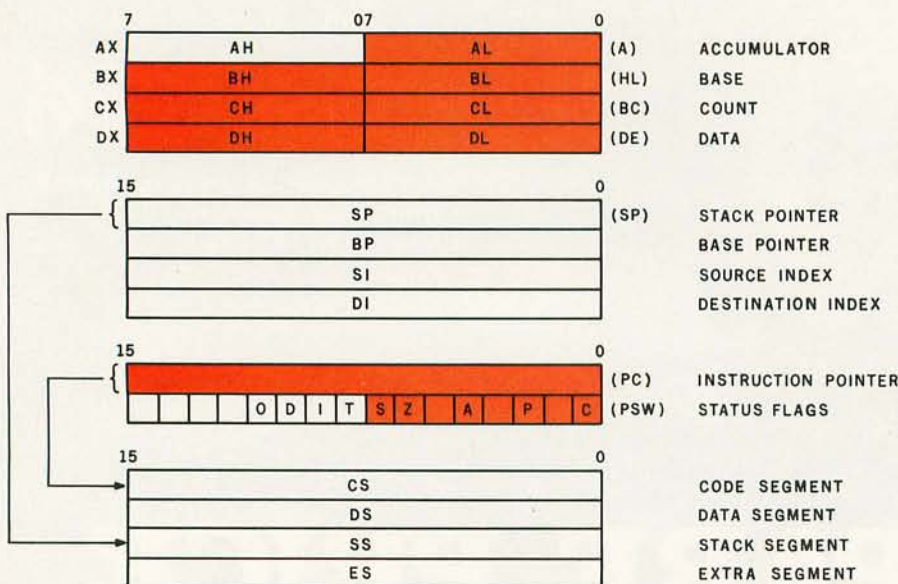

Figure 2: The 8088 contains fourteen 16-bit registers. The shaded registers are those common to the 8088 and the 8080.

Figure 2 summarizes the 8088 register set. The shaded registers are the 8080 register subset, that is, the registers that are common to the 8088 and its 8-bit predecessors.

The *general registers*, also called the HL group because they can be subdivided into *High* and *Low* bytes, include the accumulator (AX), base (BX), count (CX) and data (DX) registers. The AX register may be addressed as a 16-bit register, AX, or the high-order byte can be addressed as the register AH and the low-order byte as AL. The same holds true of the other three general registers (BX, CX, and DX).

Another group of registers is the *pointer and index* (or P and I) group. This set contains the stack pointer (SP), base pointer (BP), source index (SI), and destination index (DI)



More than meets the eye.

The new Series 5000 is mighty for its size. In more than several thousand ways!

In fact, it's the first small system offering over a megabyte of integrated mini-floppy capacity. And with its super memory management, you can have better than 300k of RAM in desk or desktop versions. But hardware is just the beginning of the story.

It's the wide selection of software that really makes this system mighty.

Operating systems? Choose CP/M* with CBASIC†—the most widely accepted small computer operating system ever. Or MVT-FAMOS,** a multi-user, multi-tasking operating system with file management like the big guys, Or MICROCOBOL,††

also for multiple users, but implemented in COBOL, familiar to commercial users the world over.

And applications programs for these operating systems number in the thousands. From real estate to accounting, taxes to inventory control, they're all available at low cost—ready to run.

When you add these software and hardware features to Industrial Micro Systems' reputation for rugged, reliable quality products you'll begin to see it all. A lot more systems than your first glance reveals.

See even more at your dealer. Call us to find out the name of your nearest dealer. He'll tell you everything you need to know. And really open your eyes!

*Trademark of Digital Research Inc.

**Trademark of MVT Microcomputer Systems Inc.

†Trademark of Software Systems

††Product of CAP-CPP

INDUSTRIAL MICRO SYSTEMS

628 N. Eckhoff St., Orange, CA 92668, (714) 978-6966
2800 Lockheed Way, Carson City, NV 89701

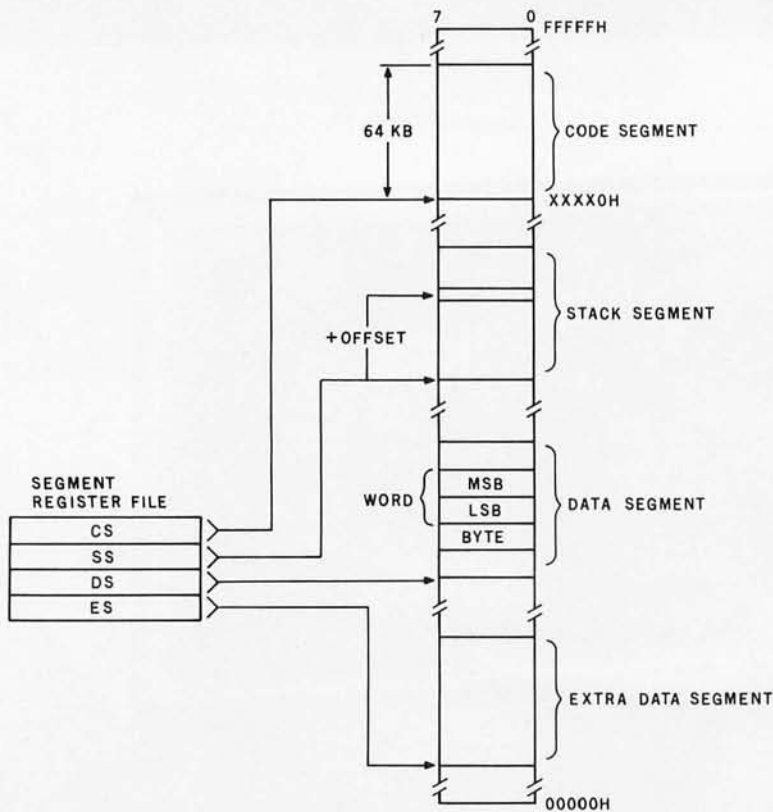

Figure 3: Memory organization. The 8088 uses a memory-segmentation technique to address up to 1,048,576 bytes (1 M byte) of memory. The user can use attributes of the memory-addressing system to dynamically relocate a program anywhere within the entire address space.

registers. Generally speaking, these registers hold offset addresses used for addressing within a segment of memory. They can also participate, along with the general register group, in arithmetic and logical operations of the 8088.

The 8088 uses memory segmentation to address this large memory space efficiently. At any one time, the 8088 can deal with memory as a set of four 64 K-byte segments. The total memory is organized as a linear array of 1,048,576 bytes, addressed as hexadecimal 00000 to hexadecimal FFFFF. The 8088 creates a 20-bit address by combining a 16-bit offset and a segment boundary value stored in one of the segment registers. Figure 3 demonstrates how this works.

Each of the 16-bit-segment registers, the code segment (CS) register, the stack segment (SS) register, the data segment (DS) register, and the extra data segment (ES) register, contains a value that is added to a 16-bit

offset address, forming a 20-bit address. The memory is thus divided into a maximum of four 64 K-byte segments that are active at any single time. The *code segment* of memory is where instructions are stored, the *stack segment* of memory is where the pushdown stack is located, the *data segment* is where data to be operated on is found in memory, and the *extra segment* is an additional 64 K-byte data area.

When fetching an instruction from memory, the location accessed is given by a 20-bit address that is the sum of two numbers. The first number is the value of the 16-bit instruction pointer. The second number is a 20-bit value that is the 16-bit code-segment register with four low-order zero bits appended. This forms the 20-bit address required to specify any location in the megabyte-sized address space.

In the case of a memory-reference operation for a transfer of data, the

absolute memory address referenced by a given memory-access instruction is calculated by adding the given 16-bit address to the base address. The base address is given by the contents of the data-segment or extra-segment register and is followed by four low-order zero bits.

In the case of a stack operation, the memory location referenced is similarly offset from the value contained in the stack-segment register.

The 8088 has both relative and absolute branch instructions. When all branch instructions within a given segment of memory are specified in relation to the instruction pointer and the program segment does not modify the value of the code-segment register, the program segment can be relocated dynamically anywhere within the megabyte address space. A program is relocated in the 8088 simply by moving the code, updating the value of the code-segment register, and resuming execution.

Small System Applications

The 8088 can be used in a broad range of applications, from systems requiring use of a minimum number of components to systems requiring maximum performance. The component-count-sensitive applications include point-of-sale terminals and simple controllers, which require that system cost be kept low, but need substantial processing power. A big reason for this design flexibility is the ability of the 8088 to operate in a minimum-hardware mode.

The minimum-mode, multiplexed configuration, as shown in figure 4, is an effective way of building a powerful system around the 8088, while using the smallest number of parts. The processor is connected in the minimum mode by wiring its Mn/Mx pin in the high-logic state (at V_{cc} potential). The multiplexed bus is directly compatible with the Intel 8085A-family peripheral components (8155, 8355, 8755A, and the new 8185).

A four-chip system can be designed using the following components: an 8088 microprocessor; an 8284 clock generator; an 8155 memory, input/output (I/O), and timer device; and an 8755A EPROM and I/O device. A fifth component, the 8185, is a simple

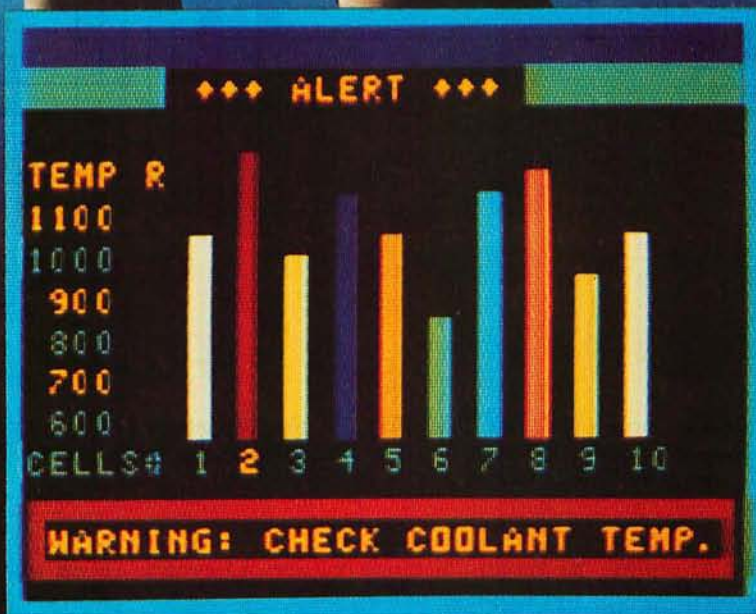

PEOPLE REACT TO COLOR!

Quite frankly, we at DIGITUS weren't surprised when our RAINBOW 2000 started showing up in industries, power facilities, and even hospitals throughout the country. They're who we designed it for.

Standard RS 232 C communication interfacing allows the RAINBOW 2000 to be adapted to any current mini or advanced system. This makes its color characteristics especially useful for

existing monitoring, control, and data storage systems. Plus, maximum ease-of-operator use and FEWER ERRORS!

The RAINBOW 2000... the peripheral that lets any system upgrade to full-color and high resolution graphics—for under \$430.

**THE RAINBOW 2000—
OUR USERS ARE FINDING IT
MORE THAN JUST FUN AND GAMES!**

FOR THE NAME OF YOUR NEAREST
RAINBOW 2000 DISTRIBUTOR
CALL DIGITUS, TOLL FREE
1-800-638-1473

In Maryland,
301-467-3223

DEALER
INQUIRIES
WELCOME



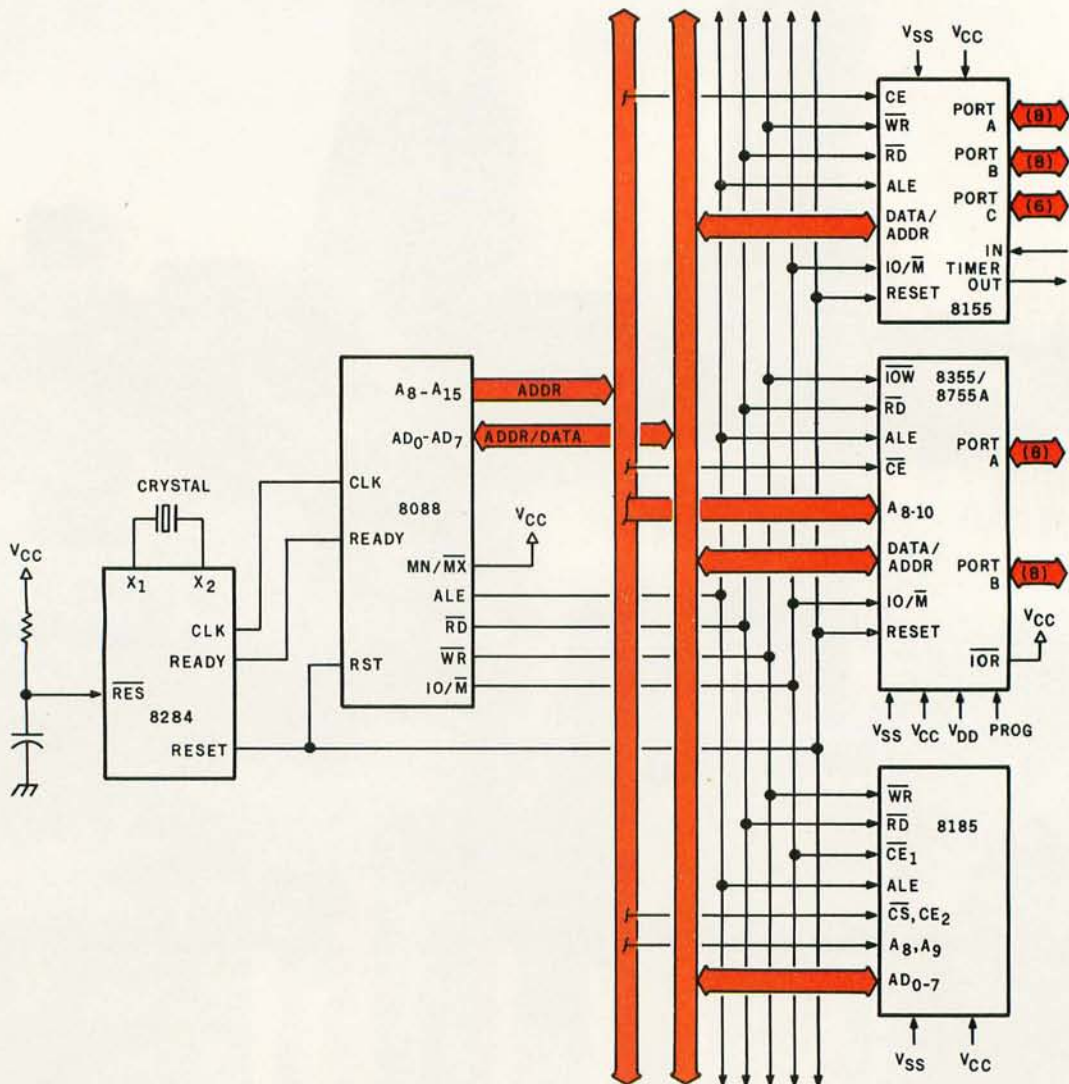

Figure 4: When used in the minimum mode (MN/\overline{MX} line held high), the 8088 interfaces directly with the multiplexed address and data components in the 8085A-support family to form a functional microcomputer system using only five integrated circuits. Detailed information concerning this circuit will be given in Part 2.

addition to the system and provides an extra 1 K bytes of user memory.

In the minimum-mode configuration, the 8088 provides all necessary bus-control signals, including \overline{RD} , \overline{WR} , IO/\overline{M} and ALE. It further provides HOLD and HLDA (hold-acknowledge) signals to allow direct-memory-access (DMA) data transfer, INT and \overline{INTA} to interface the 8259A interrupt controller, and \overline{DEN} and DT/\overline{R} to control transceivers on the data bus.

The power of the 8088 can be extended in large-system applications by wiring it into the maximum-mode configuration. However, a discussion

of maximum-mode features is beyond the scope of this article.

The 8088 Instruction Set

A complete discussion of the 8088's instruction set is also beyond the scope of this article. Rather than attempt it, I shall concentrate on some specific features of the 8088 instruction set that facilitate the specific application discussed next month in Part 2 of this article. These features include extended arithmetic instructions, direct use of ASCII-encoded data, multiprocessing features, string-manipulation instructions, and table-translating aids. The

8088 instruction set includes single-instruction multiplication and division instructions, along with five different types of addition and seven types of subtraction operations.

These multiply and divide instructions greatly facilitate "number crunching." This numerical ability saves much time in such applications as data sampling, signal processing, and scientific calculation. Not only are fewer machine instructions needed to perform a given task, with corresponding savings in memory usage and execution time, but the versatility of the instructions and the

Text continued on page 30

Little Impact.



Meet the IMPs. A pair of stylish 3½ inch high impact printers that will look great on any desk.

Styled for desk top use, these sleek units stand just 3½ inches high, yet the unique fan-cooled printing system can knock out 80, 96 or 132 columns of crisp hardcopy with continuous throughput of one line per second.

A winning pair. IMP-1, with friction feed, can make multi-copies on plain 8½ inch wide paper, or on teletype rolls. In addition, IMP-2 has tractor feed and full forms control, with tractors adjustable from 1 inch to 9½ inches.

Interfaces abound. All IMPs have Centronics parallel and RS232C/20mA serial inputs as standard equipment. But if you need something different, then we make interfaces for just about any system — high speed serial, Apple, Pet, TRS-80, IEEE 488...

Versatile, too. 96 ASCII character set is standard. And you can select 6 character sizes, even graphics, under software control. Options include 2K buffering and special character sets.

Service — a big difference. No other printer manufacturer offers Axiom's combination of low cost and nation-wide service and distribution — in the USA and eighteen overseas countries.

Pssst — the price!!! It's low. \$695 for IMP-1. \$795 for IMP-2. And that's the single unit price.

Better phone, write or mail the bingo card today!

AXIOM
AXIOM CORPORATION

5932 San Fernando Road, Glendale, CA 91202
Tel: (213) 245-9244 • TWX: 910-497-2283

Without an Eaton LRC Printer you

Get serious



are just playing computer games.

for only \$389.

Introducing the New Eaton LRC 7000+ Dot-Matrix Impact Printer.

No matter what type of personal computer you now have, or are thinking of buying —

Apple	Interact
Cromemco	Commodore Pet
TRS-80	Northstar
TI	Ohio Scientific
Exidy	and others

— the new Eaton LRC 7000+ dot-matrix impact printer will quickly interface and be printing in a matter of seconds. You'll immediately have hard copy capabilities that will allow you to go beyond computer games and get down to serious business.

An Invaluable Addition

Adding a printer increases the practicality and usefulness of your personal computer dramatically. You'll be able to perform all sorts of bookkeeping and accounting functions — from balancing your personal checkbook to monitoring your company's inventory — and you'll have a permanent copy for your records. You'll find that whether you're controlling your family's budget, recording your program listing, plotting the



growth of a stock in the market, or any of the other thousands of analytical functions your computer can perform, a quality printer is simply invaluable. But you'll want to be sure to pick the right printer for your system.

The Right Printer



The Eaton LRC 7000+ is designed specifically for personal computers. Its plug-in simplicity makes it remarkably easy to interface with any computer. Its simple design features the fewest possible moving parts, making it virtually maintenance free. Unlike many other printers, the 7000+ can print on any type of roll paper, eliminating the hassle and added expense of purchasing a special, treated paper. Its rugged case is tough enough for industrial environments, yet attractive enough for home or office use. And most importantly, it offers the high performance and features you demand in a quality printer.

Super Performance

The 7000+ features uni-directional printing with a line speed of 1.25 lines per second. It accepts any single or two-ply paper roll from 3/4 inch to 3-7/8 inches wide, and prints a 3-1/3 inch line. Capacity is adjustable and can be 40 columns at 12 characters to the inch using the single width font; or 20 columns at 6 characters to the inch using the double-wide font. An available option allows the unit to print 64 columns at the single width setting, and 32 columns using a double width font.

An Unbeatable Price

The real beauty of the new 7000+ is the fact that you can't buy another printer that offers you all these features at anywhere near the price. Eaton LRC's 7000+ has a suggested retail price of \$389.00 and comes with a 90-day factory warranty.

Specify Eaton LRC

Whether you're looking for a quality printer to add to your existing computer, or are about to buy a complete system, don't settle for less than an Eaton LRC printer. Stop by your local Computerland store or contact Quest Electronics, 2322 Walsh Avenue, Santa Clara, CA 95051, (408) 988-1640 or Sigma International, Inc., P.O. Box 1118, Scottsdale, AZ 85252, (602) 994-3436 for more information. Once you've seen the new 7000+, you won't settle for anything less. LRC, an EATON company, Riverton, Wyoming 82501, (307) 856-4821.

Master distributor inquiries welcome. Contact your nearest LRC Regional Sales Office: Northeastern office, One Lakeside Office Park, Wakefield, MA 01880, (617) 245-2730; Southeastern office, 29 Delmont Drive Northeast, Atlanta, GA 30305, (404) 231-4105; Western office, 510 Lawrence Expressway, Suite 210, Sunnyvale, CA 94086, (408) 245-1590.

an **EATON** company

Listing 1: An example of the efficiency of the 8088 and 8086 instruction set. This short routine accepts input of five values from an input port, and then calculates and sends a running-average value to an output port. Compare this listing with listing 2.

```

XOR    BX, BX           ;CLR BX
MOV    CX, 5           ; Set loop counter

Average INC    BL           ;Increment data counter
        IN     AL, Port # ;Input data
        ADD   BH, AL      ;Update running total
        MOV   AL, BH
        DIV  BL           ;Divide running total by
                           ;data counter.

        OUT   Port #, AL ;Output running average.

        LOOP Average     ;Return unless fifth pass
                           ;is completed.

        HLT

```

Listing 2: A routine that performs the same task as the routine given in listing 1. This code, however, was written for the older 8080 processor. As you can see, it is longer and more tedious to write.

```

MVI    H,00           ;Clear H register
MVI    E,00           ;Clear E register

Average INR    E           ;Increment data counter

        MOV   C, H
        IN   A, Port #   ;Input data
        ADD  H           ;Add data to running total

Divide  XRA    A           ;Clear accumulator
        MOV  B, A
        MOV  L, A
        MVI  C, 80        ;Initialize bit counter

Loop    MOV   A, C
        RAL           ;Shift B and C as
        ;a 16-bit unit—
        MOV  C, A
        MOV  A, B
        RAL
        MOV  B, A

        CMP  E           ;Compare data
        JC  Next         ;counter (divisor) with
                           ;dividend; if divisor is larger,
                           ;bypass subtract.
                           ;Divisor is smaller; subtract.

        SUB  E
        MOV  B, A
        MOV  A, D
        ORA  L
        MOV  L, A

Next    MOV   A, D
        RRC           ;Shift D right and check carry
        JNC  Loop      ;If no carry, return for next bit.

        MOV  A, L
        OUT  Output # ;Outport running average

        MVI  A, 05
        CMP  E
        JNZ  Average   ;Return unless fifth pass is
                           ;completed.

        HLT

```

Text continued from page 26

ability of the 8088 to deal with several types of data remove the usual necessity of handling messy conversions from one type of data representation to another and back again.

Two program listings demonstrate the saving of effort. Listing 1 gives the 8088 code for the skeleton of a subroutine that accepts data from a specified input port and calculates a running average of the values entered. The same subroutine section coded for the older 8080 microprocessor is shown in listing 2.

Direct Use of ASCII and Decimal Data

The direct use of unpacked binary-coded decimal (BCD) or ASCII-encoded data in a microcomputer has a number of obvious advantages. Since many I/O devices present data to the processor in American Standard Code for Information Interchange (ASCII) format and expect responses in the same format, microcomputer-system designers have for years faced the necessity of putting their input and output through a translation process (usually involving a table look-up operation) before processing the input or responding with output.

With the 8088's instruction set, such manipulation is no longer necessary. All four mathematical instruction types (add, subtract, multiply, and divide) provide for ASCII adjustment of the accumulator contents by a single instruction. This feature is obviously of great use in everyday microprocessor applications. Equally interesting (and useful) are the two instructions that adjust the results of addition and subtraction to packed decimal form.

Table-Translating Aid

Despite the availability of single instructions to convert accumulator contents from one type of data representation to another, it may still be necessary from time to time to translate data by means of the traditional look-up table. This might, for example, be necessary if the data is being received or transmitted in EBCDIC (Extended Binary-Coded-Decimal Interchange Code) rather than in ASCII form.

New on the North Star Horizon: 18Mb Hard Disk Drive!

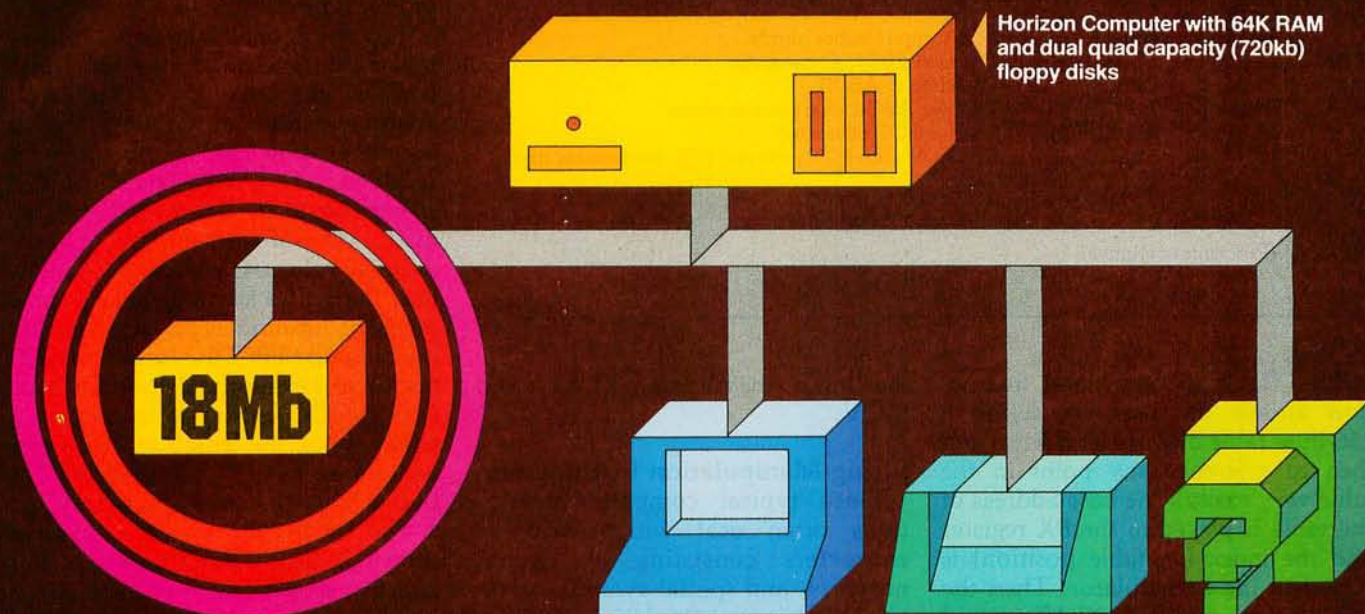

Horizon Computer with 64K RAM and dual quad capacity (720kb) floppy disks

Up to four 18Mb Winchester-type hard disk drives

Display terminal

Letter-quality or dot matrix printer

Horizon I/O flexibility allows expansion to meet your needs

Unsurpassed Performance and Capacity!

North Star now gives you hard disk capacity and processing performance never before possible at such a low price! Horizon is a proven, reliable, affordable computer system with unique hardware and software. Now the Horizon's capabilities are expanded to meet your growing system requirements. In addition to hard disk performance, the Horizon has I/O versatility and an optional hardware floating point board for high-performance number crunching. The North Star large disk is a Century Data Marksman, a Winchester-type drive that holds 18 million bytes of formatted data. The North Star controller interfaces the drive(s) to the Horizon and takes full advantage

of the high-performance characteristics of the drive. Our hard disk operating system implements a powerful file system as well as backup and recovery on floppy diskette.

Software Is The Key!

The Horizon's success to date has been built on the quality of its system software (BASIC, DOS, PASCAL) and the very broad range and availability of application software. This reputation continues with our new hard disk system. Existing software is upward compatible for use with the hard disk system. And, with the dramatic increase in on-line storage and speed, there will be a continually expanding library of readily available application software. For more information, see your North Star dealer!

NorthStar

North Star Computers Inc.
1440 Fourth St.
Berkeley, CA 94710
(415) 527-6950 TWX/Telex 910-366-7001

HORIZON—HD-1

Horizon computer with 64K RAM, 2 quad capacity mini drives and one HD-18 hard disk drive **\$9329**

HD-18

Additional 18Mb hard disk drive for expansion of HD-1, or your present Horizon **\$4999**

SYS-1N

Complete Horizon HD-1 plus 80 x 24 display terminal and NEC Spinwriter printer **\$13,239**

SYS-1A

Complete Horizon HD-1 with 80 x 24 display terminal and Anadex printer **\$11,319**

Listing 3: A segment of 8088 code that translates characters from Extended Binary-Coded-Decimal Interchange Code (EBCDIC) to American Standard Code for Information Interchange (ASCII) form. The 8088 instructions for manipulating and translating strings of characters are put to good use.

```

MOV     SI, FFFE      ; Source index register contains start of EBCDIC Buffer
MOV     BX, 0100     ; B register points to translate table
MOV     DI, ASCBUF   ; Destination index points to ASCII buffer
MOV     CX, 528      ; C register contains length of buffer
CLD
JCXZ   EMPTY        ; Skip if input buffer empty
NEXT:  LODS          ; Get next EBCDIC character
      XLAT          ; Translate to ASCII
      STOS          ; Transfer ASCII character to buffer
      CMP          AL, EOT ; Test for EOT character
      LOOPNE      NEXT ; Continue if no EOT received (CX decrements first)
      .
      .
EMPTY: (Program continues)

```

The XLAT (ie: translate) instruction allows the user to define a 256-byte table of correspondence and then to reference any point in the table very easily. The base address of the table is placed in the BX register and the index (ie: table position) is stored in the accumulator. Then the single instruction code XLAT is used to refer to the proper point in the table, pick out the translation, and store the result in the accumulator.

This is useful particularly when data that has been entered from a port comes into the accumulator for disposition or transfer. If you are dealing with a stream of incoming characters in EBCDIC format, for example, the translation proceeds thusly. You begin by storing the beginning memory address of your 256-byte translation table in the BX register. If you set up the table so that the base address of the table corresponds to an incoming EBCDIC value of 00, the next address to an incoming value of 01, etc, all you must do is simply accept a byte of data and execute the XLAT instruction.

This simple procedure lets us obtain the correct translation of that byte into the proper format for handling by the 8088 or some other processor. A MOV instruction will then store the result of translation until it is needed; the translation process can then be repeated with the next incoming byte. Setting up the necessary instruction sequence requires one instruction: a MOV to the BX register of the base address of the table. The loop for handling the translation requires only three basic instructions:

the input instruction, XLAT, and MOV.

String-Manipulation Instructions

Since typical computer applications often deal with strings of characters consisting of letters, numbers, and special symbols, easy-to-use string-manipulation instructions are a welcome enhancement to 8-bit processors. The 8088 addresses this need by providing five powerful primitive string operators that may be preceded by a single-byte repetition prefix.

For a byte-for-byte or word-for-word comparison of two data strings (as you might use in verifying the accuracy of data loaded into memory from a mass-storage device, for example), the 8088 offers the CMPS instruction. This also allows termination of a program segment upon occurrence of a predetermined equality or inequality condition, as well as automatic incrementing or decrementing.

You can scan through a string of data for an occurrence or for an absence of occurrence of a specific string or character by using the SCAS instruction. This operation subtracts the byte or word operand in memory (or elsewhere) from the accumulator and changes the logic state of the flags; it does not, however, return a result. Again, decrementing or incrementing is automatic.

The STOS instruction allows you to fill a string of arbitrary length with a single value (eg: a string of zeros or nulls for a floppy disk initialization routine), once more with automatic

incrementing or decrementing of a predetermined count.

Putting Some Things Together

Let's take a quick look at a small but powerful example that employs both the string manipulation and the XLAT instructions to solve a very practical problem.

You are designing an input routine that must translate a buffer filled with EBCDIC characters into ASCII form, continuing the transfer until one of several possible EBCDIC characters is received. The transferred ASCII string should be terminated with an EOT (end-of-transmission, hexadecimal value 04) character. Assume that the buffer starts at hexadecimal memory location FFFE, the table to translate the EBCDIC form to ASCII begins at hexadecimal location 0100 and the CX register is to contain a value giving the length of the buffer containing EBCDIC characters. The buffer may, of course, be empty.

The small 8088 program segment shown in listing 3 accomplishes this task in a small number of instructions and handles a great deal of overhead work with little effort or concern on the part of the system designer and programmer.

By now you should have an understanding of the power of the 8088 microprocessor. Even in a minimal-mode, five-component circuit, our little computer will have the following attributes:

- 5 MHz 8088 8-bit processor (completely 8086 software-compatible)
- 1280 bytes of static user memory
- 2048 bytes of erasable, programmable read-only memory (EPROM)
- 38 parallel I/O lines
- a 14-bit counter/timer
- power-on reset and nonmaskable interrupt.

Next month, in Part 2, we will deal with some key features of the 8088 which make it particularly suited to multiprocessing situations. We will investigate the operating system of a multi-user, Tiny BASIC language system on our minimal-configuration computer. ■

These figures are provided through the courtesy of Intel Corporation.

A MCGRAW-HILL PUBLICATION

onComputing™

GUIDE TO PERSONAL COMPUTING

GETTING STARTED
What You Need And What It Will Cost

EQUIPMENT REVIEWS
TRS-80, Apple, Sorcerer and PET

Best-Selling Author
JERRY POURNELLE
"Writing With A Microcomputer"
THE BINARY WORLD

Also...
**A PERSONAL
COMPUTER DIRECTORY**
**COMPUTER CLUBS:
WHO NEEDS THEM?**

Plus much much more
for the new computer user



When will the Personal Computer Explosion touch YOU?

Are you prepared for the explosive transformation? Right in your own home? Electronic mail. Personalized investment analysis. Foreign language tutorial. Home energy management. Robots. Computer music. Secretarial service. Diet and menu planning. And more, more, more.

onComputing™ the new McGraw-Hill quarterly, prepares you for the enormous changes coming during the



1980's (Some are already here). **onComputing™** explains in nontechnical language what personal computers are, how they work, and how you can use them at home, for fun and profit.

Don't let the personal computer explosion catch you off guard. Know what's happening and help make it happen! Prepare now for the exciting future with a subscription to **onComputing™!**

Call Toll-Free
800-258-5485

Start your
subscription today.

onComputing™ Subscription Dept. P.O. Box 307, Martinsville, NJ 08836

DOMESTIC subscription rate:

U.S. 1 yr. (4 issues) @ \$8.50 Canada & Mexico, 1 yr. (4 issues) @ \$10.00

FOREIGN (to expedite service, please remit in U.S. funds drawn on a U.S. bank.)

Europe (and all other countries, except above), 1 yr. @ \$12.00 — surface delivery.

Bill Visa Bill Master Charge Bill me (North America only)

Card Number

Expiration

Signature

Name (please print)

Street/Apartment Number

City

State/Province/Country Code

Please allow 6-8 weeks for processing.

Electron Behavior in a Chemical Bond

Michael Liebl, OSB
Mount Michael High School
Elkhorn NB 68022

Years spent subconsciously gathering and sifting data in our daily lives gives each of us a common sense intuition for the laws of nature. But our intuitive understanding of how nature works often fails when we explore worlds beyond the realm of common experience. In the sub-microscopic world of atoms and molecules, matter exhibits unexpected behavior attributable to its dual nature as particle and wave. Scientists interpret this world with the aid of quantum mechanics, a discipline that more often than not involves long and complicated mathematical operations.

The computer, by virtue of the ease and speed with which it handles such operations, has become an invaluable tool in the quantum-mechanical study of atoms and molecules. This article describes a program written in BASIC which allows anyone with an elementary understanding of quantum mechanics to investigate the behavior of an electron in the bond formed between two atoms in a diatomic molecule.

Electronic Potential Well

A chemical bond is the result of attractive, electric interaction between the atoms' electrons which are negatively charged and the nuclei which are positively charged. Opposite charges attract; like charges repel. In the vicinity of the nucleus of an atom, an electron feels an attractive force. The environment in which the electron is subject to this force is

described as a *potential*. A rectangular *potential well*, as shown in figure 1, is an approximate model of the relation between an electron and its nucleus. The depth of this rectangular well determines the extent to which the electron is confined to the region about the nucleus. If the well is deep, it is difficult for the electron to cross the boundaries of the high walls. If, on the other hand, the well is shallow, then it is relatively easy for the electron to escape the nucleus.

A molecular bond can form when two atoms exchange or share an electron. For example, table salt is composed of two elements, sodium, an alkali metal, and chlorine, a halogen. Sodium, like all alkalis, can arrive at a stable electronic configuration by giving away one of its electrons to form a positively charged sodium ion. This element has a *shallow*

potential well. Chlorine, like all halogens, can arrive at a stable electronic configuration by accepting an extra electron to form a negatively charged chloride ion. Chlorine has a *deep* potential well.

A bond can form between a sodium atom and a chlorine atom, and between any alkali and any halogen, when the former donates an electron to the latter. The result is a molecule, the positively charged sodium ion bound to the negatively charged chloride ion. We will use the potential well model to study different elements and the bonds that they make.

No two elements are exactly alike either in their ability to receive or in their ability to donate an electron. Thus the behavior of the electron in a chemical bond depends upon certain properties of the two elements involved. To determine the depth of the rectangular potential well for a given element, we will refer to two characteristic properties of the elements: ionization potential and electron affinity.

Ionization potential is a measure of the amount of energy required to remove an electron from a neutral atom of some element X: $X \rightarrow X^+ + e^-$. For alkalis this number is small, for halogens large. *Electron affinity* is a measure of the amount of energy released when a neutral atom acquires an extra electron: $X + e^- \rightarrow X^-$. For alkalis this number is 0, for halogens the number is large. (For values of ionization potentials and

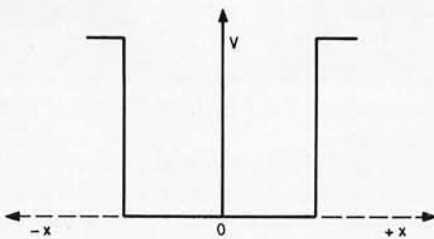

Figure 1: Rectangular potential well model that approximates the relation of an electron to the nucleus of an atom. The depth of the well indicates the extent to which the electron is confined to the region about the nucleus.

The Solution Store



Your Computer Store for the 80's.

MicroAge Computer Stores were designed for the 80's . . . and beyond. Designed to provide solutions, not just to sell hardware. From systems integration to easy-to-use application software. From research and development to warranty service and repair.

From systems consulting to training and installation. In all these, we are the acknowledged leaders, the industry pioneers. The model for all

computer stores of the future. Don't just take our word for it. Visit the MicroAge Computer Store nearest you. You'll leave with a whole new idea about what a computer store is all about . . . and will be for years to come.

MicroAge
COMPUTER STORES

Circle 15 on inquiry card.

Paradise Valley Mall
(Cactus Rd. & Tatum Blvd.)
Phoenix, Arizona

1220 Melbourne Dr.
Hurst, Texas

2525 N. Scottsdale Rd.
Scottsdale, Arizona

Spring Valley Rd. & Coit St.
Richardson, Texas

2612 East Broadway
Tucson, Arizona

24 West Camelback Rd.
Phoenix, Arizona

For franchise opportunities, contact the director of franchising, (602) 967-1421.

electron affinities see the *Handbook of Chemistry and Physics* published by the Chemical Rubber Company.) The depth of the potential well of any element, that is, its ability to hold on to an electron, can be estimated by averaging the element's ionization potential and electron affinity.

Composite Potential Model

When two atoms form a *diatomic* molecule, each of the atoms brings its potential well to the bond. The electron exchanged or shared by the two atoms can be pictured as being confined to a composite rectangular well that consists of the two potential wells placed side by side, as shown in figure 2. Unless the two atoms are of the same element, one side of the composite well will be deeper than the other. The difference in height between the two levels of the well is the essential feature of the bond which determines how much time the electron spends in the vicinity of one atom's nucleus as compared to the other.

Because the *difference* in height is the crucial factor, the lower level of the potential well can always be

assigned as the origin on the potential axis of a Cartesian coordinate system. The upper level of the well is located at the point that represents the difference between the averages of the ionization energies and electron affinities of the two elements. Finally, it is also convenient to assume that the walls of the potential well at the endpoints of the bond are infinitely high. Given this assumption, it is impossible for the electron to escape the confines of the molecule. This potential model of the bond in a diatomic molecule simplifies the equations that describe the behavior of the electron in the bond.

Schrödinger Wave Equation

In 1926, Erwin Schrödinger formulated a differential equation to describe the behavior of a submicroscopic particle such as an electron. This equation incorporates both the particle and wave nature of the electron. Fundamentally, Schrödinger's equation is a restatement of the basic energy relation; the kinetic energy, $p^2/2m$ (derived from momentum and mass), plus the potential energy, V , yields the total energy, E ,

of any particle:

$$p^2/2m + V = E$$

Schrödinger's equation takes the form:

$$-\frac{\hbar^2}{2m} \frac{d^2\psi}{dx^2} + V\psi = E\psi$$

for a single-dimension model.

In the equation, \hbar is read as "h-bar," and stands for a value equal to Planck's constant divided by 2π . Planck's constant, h , is an empirically determined value equal to 6.6256×10^{-34} Joule-seconds. The mass of the particle is shown as m . The Greek psi (ψ) is the notation for the wave function. In Schrödinger's formulation, the energy equation has been multiplied by a wave function, ψ , to account for the wave-like behavior of submicroscopic particles, and the square of the momentum has been replaced by the differential operator, $-\hbar^2 d^2/dx^2$.

When the Schrödinger equation is solved for a particular set of circumstances, called *boundary conditions*, it yields as a solution the form of ψ , the wave equation. ψ^2 gives the relative probability, for the conditions assumed, of finding the particle it describes at some point in space. It is known as the *probability distribution function*.

In our model, the depth of the rectangular potential well is a measure of the magnitude of the potential energy, V , which acts on the electron and affects its location. In a split-level well the deeper side exerts a greater force on the electron. Therefore we

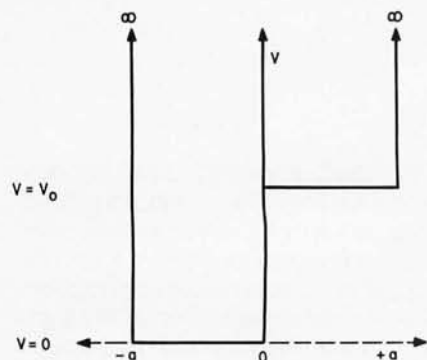

Figure 2: When a diatomic molecule is formed, the relationship between the two atoms may be considered as a combination of two potential wells.

SUPERPASCAL

5-10 times faster...
and more!

Meet Pascal/Z,TM the fast, flexible compiler with higher speed, greater efficiency and improved debugging:

- True Z-80 native code Pascal compiler—5-10X faster than competing P-code implementations—no interpreter required.
- The only multi-tasking Pascal—produces ROMable re-entrant code.
- Optimized for fastest execution—recognizes and exploits special cases.
- Easily transportable—all hooks to your system made through support library.
- Includes standard floating point package. Single copy on CP/M-compatible disk includes compiler, companion macro-assembler & source of the library, \$395. OEM licenses available. Write or call for more information.

InterSystemsTM

Ithaca Intersystems Inc., 1650 Hanshaw Road/P.O. Box 91,
Ithaca, NY 14850/607-257-0190/TWX: 510255 4346

© 1979 Ithaca Intersystems Inc.

m	mass of an electron; 9.109×10^{-31} kilograms
q	charge on an electron; 1.602×10^{-19} Coulombs
\hbar	Planck's constant divided by 2π ; 0.658×10^{-15} electron-volt-seconds
p	momentum of the electron
a	length of chemical bond
V_0	potential difference between elements
E	total energy of the electron
A	coefficient of the wave equation, ψ_L , for the left side of the potential well
B	coefficient of the wave equation, $\psi_{R,1}$, for the right side of the potential well when $E > V_0$
C, D	coefficients of the wave equation, $\psi_{R,2}$, for the right side of the potential well when $E < V_0$

Table 1: Symbols and constants that are used throughout this article.

would expect the probability distribution function, ψ^2 , to be skewed toward the deeper side of the well.

Two-Part Equation Solution

For the potential well pictured in figure 2, the Schrödinger equation is solved in two parts, corresponding to the lower or left side and to the upper or right side of the well. The potential in the left side of the well is equal to zero. The potential in the right side of the well is equal to the difference between the potentials of the two elements, V_0 .

The wave-equation solution, ψ , must meet four requirements:

- At the left boundary of the well, the potential wall is infinitely high. There is no possibility for the electron to pass beyond this point. Therefore at $x = -a$, the value of the function ψ_L must be zero.
- Similarly, the wall at the right boundary is infinitely high. There is no possibility for the electron to pass beyond this point. Consequently at $x = +a$, ψ_R must also be equal to zero.
- We are studying a single electron. Although we attack the solution in two parts that correspond to the two sides of the potential well, a

Text continued on page 44

Listing 1: BASIC program that solves the Schrödinger equation to simulate the behavior of an electron in a diatomic chemical bond. The program finds αa , βa , and γa in terms of V_0 .

The correspondence of variables in the program to terms in the equations is as follows: A1 stands for αa ; B1 stands for βa ; G1 stands for γa ; V0 stands for V_0 .

```

10 REM PROFILE OF A CHEMICAL BOND IN A DIATOMIC MOLECULE
20 REM WRITTEN BY MICHAEL LIEBL
30 REM CALCULATION OF N AND V0
40 REM PROGRAM LINES 10-1000
50 PRINT : PRINT : PRINT
60 DIM S$(10),R(10),IP(10),EA(10)
70 PRINT TAB(20);"-PROFILE OF A CHEMICAL BOND--"
80 PRINT
90 PRINT"      THE ELECTRON DENSITY IN THE CHEMICAL BOND OF A DIATOMIC MOLECULE"
100 PRINT"DEPENDS UPON THE POTENTIAL DIFFERENCE (V0) BETWEEN THE TWO ELEMENTS"
110 PRINT"WHICH ARE BOUND TOGETHER AND UPON THE LENGTH OF THE BOND (A).  THE"
120 PRINT"AVERAGE OF THE IONIZATION ENERGY AND THE ELECTRON AFFINITY OF AN"
130 PRINT"ELEMENT OFFERS A MEASURE OF THE POTENTIAL OF THE ELEMENT."
140 PRINT
150 PRINT"      THIS PROGRAM CALCULATES A PROFILE OF A CHEMICAL BOND BASED"
160 PRINT"UPON THIS INFORMATION.  FROM THE LIST OF ELEMENTS BELOW, SELECT TWO"
170 PRINT"WHICH WILL MAKE UP THE MOLECULE.  ENTER THE SYMBOLS FOR THESE"
180 PRINT"ELEMENTS AT THE REQUEST OF THE PROGRAM."
190 PRINT : PRINT
195 F=0
200 PRINT TAB(10)"HYDROGEN   -  H"
210 PRINT TAB(10)"LITHIUM    -  Li";TAB(40)"FLUORINE   -  F"
220 PRINT TAB(10)"SODIUM     -  Na";TAB(40)"CHLORINE   -  Cl"
230 PRINT TAB(10)"POTASSIUM  -  K";TAB(40)"BROMINE    -  Br"
240 PRINT TAB(10)"RUBIDIUM   -  Rb";TAB(40)"IODINE     -  I"
250 PRINT TAB(10)"CESIUM    -  Cs"
260 PRINT
270 PRINT
280 INPUT"ENTER ELEMENT NUMBER ONE - ";A$
290 FOR I=1 TO 10
300 READ S$(I),R(I),IP(I),EA(I)
310 IF S$(I) <> A$ THEN NEXT I
320 IF I > 11 THEN 350
330 GOSUB 800
340 GOTO 280
350 RESTORE
360 INPUT"ENTER ELEMENT NUMBER TWO - ";A$
370 FOR J=1 TO 10
380 READ S$(J),R(J),IP(J),EA(J)
390 IF S$(J) <> A$ THEN NEXT J
400 IF J > 11 THEN 430

```

Listing 1 continued on page 38

Listing 1 continued:

```
410 GOSUB 800
420 GOTO 360
430 RESTORE
440 PRINT : PRINT : PRINT
450 M=9.109E-31
460 Q9=1.602E-19
470 H=0.658E-15
480 A=(R(I)+R(J))*1E-10
490 V1=(IP(I)+EA(I))/2
500 V2=(IP(J)+EA(J))/2
510 V0=V2-V1
520 IF V0<0 THEN V0=-V0
530 N=SQR(2*M*V0/Q9)*A/H
540 N2=N^2
550 PRINT"V0 = ";
560 PRINT USING"###.###";V0
570 PRINT" N = ";
580 PRINT USING"###.###";N
590 PRINT : PRINT : PRINT
600 INPUT"WHEN READY TO CONTINUE TYPE A CARRIAGE RETURN. ";A$
610 GOTO 1010
800 REM SYMBOL ENTRY ERROR
810 PRINT
820 PRINT"THE CHEMICAL SYMBOL ENTERED DOES NOT MATCH ANY IN THE FILE. CHECK"
830 PRINT"THE LIST AND TRY AGAIN."
840 PRINT
850 RESTORE
860 RETURN
900 REM DATA FILE
910 DATA H, 1.54, 13.595, 0.80
920 DATA Li, 0.68, 5.39, 0
930 DATA Na, 0.97, 5.138, 0
940 DATA K, 1.33, 4.339, 0
950 DATA Rb, 1.47, 4.176, 0
960 DATA Cs, 1.67, 3.893, 0
970 DATA F, 1.33, 17.418, 3.448
980 DATA Cl, 1.81, 13.01, 3.613
990 DATA Br, 1.96, 11.84, 3.363
1000 DATA I, 2.20, 10.454, 3.063
1010 REM CALCULATION OF A1 AND B1 OR G1, LINES 1010-1780
1020 PRINT
1030 PRINT"GRAPHICAL SOLUTION OF"
1040 PRINT"TRANSCENDENTAL EQUATION"
1050 PRINT
1060 PRINT TAB(6);"-30";TAB(36);"0";TAB(64);"+30"
1070 FOR A=1 TO 60
1080 PRINT TAB(A+6);"-";
1090 NEXT A
1100 PRINT
1110 PRINT " -A1-";TAB(36);"!"
1120 FOR A1=.1 TO 3.2 STEP .1
1130 PRINT USING " #.###";A1;
1140 PRINT"--1";
1150 A2=A1^2
1160 GOSUB 1530
1170 IF INT(Y1)=INT(Y2) THEN GOTO 1290
1180 IF Y2<Y1 THEN GOTO 1240
1190 IF ABS(Y1)<=30 THEN PRINT TAB(36+Y1);"+";
1200 IF ABS(Y2)<=30 THEN PRINT TAB(36+Y2);"*" ELSE GOTO 1220
1210 GOTO 1300
1220 PRINT""
1230 GOTO 1300
1240 IF ABS(Y2)<=30 THEN PRINT TAB(36+Y2);"*";
1250 IF ABS(Y1)<=30 THEN PRINT TAB(36+Y1);"+" ELSE GOTO 1270
1260 GOTO 1300
```

Listing 1 continued on page 40

CHOICE PRINTERS FOR THE SMALL BUSINESS FROM CENTRONICS.



Now the small business can have the advantage of Centronics performance. With the introduction of a new series of low-cost printers designed to meet the needs of the small business, Centronics' features and reliability are yours for the choosing. We have models with high thruput for inventory control, full 132 column width

for accounts receivable, versatile forms-handling capability for invoicing, payroll and statements. Plus excellent print quality for correspondence labels and listings. And, we support you with the largest worldwide service organization of any independent printing company.

You can see the Centronics printers

at your Authorized Hamilton/Avnet dealer who can assist you in deciding which one is best suited to your particular application.

Circle 17 on inquiry card.

Hamilton Avnet
ELECTRONICS  A DIV. OF AVNET INC.

CENTRONICS FROM YOUR LOCAL DEALER

For the name of your nearest Authorized Hamilton/Avnet Dealer, just call our toll-free number:

CALL TOLL-FREE:

1-800-252-0627

IN CALIFORNIA CALL TOLL-FREE:

1-800-421-4645

Listing 1 continued:

```

1270 PRINT""
1280 GOTO 1300
1290 PRINT TAB(36+Y1);"x"
1300 NEXT A1
1310 FOR A=1 TO 60
1320 PRINT TAB(6+A);"-";
1330 NEXT A
1340 FOR A=1 TO 3
1350 PRINT
1360 NEXT
1370 PRINT"AT WHAT VALUE OF A1 DO THE LINES SEEM TO INTERSECT?"
1380 PRINT"A1= ";
1390 INPUT A1
1400 IF N=0 THEN A1=1.57079
1410 G9=1000
1420 A1=A1+.0004
1430 A2=A1^2
1440 GOSUB 1530
1450 IF S<G9 THEN G9=S ELSE GOTO 1480
1460 IF A1=3.1416 THEN PRINT"DID NOT FIND POINT OF INTERSECTION"
1470 GOTO 1420
1480 PRINT
1490 PRINT"THE POINT OF INTERSECTION IS:"
1500 PRINT"A1= ";
1510 PRINT USING "##.###"; (A1-.0004)
1520 GOTO 1670
1530 REM SUBROUTINE FOR TRANSCENDENTAL EQUATION
1540 IF N>A1 THEN GOTO 1560 ELSE GOTO 1610
1550 REM PAIR OF EQUATIONS FOR N>A1
1560 Q1=SQR(N2-A2)
1570 Y1=Q1*SIN(A1)/(A1*COS(A1))
1580 Y2=-(EXP(Q1)-EXP(-Q1))/(EXP(Q1)+EXP(-Q1))
1590 S=(Y1-Y2)^2
1600 RETURN
1610 REM PAIR OF EQUATIONS FOR N<A1
1620 Q2=SQR(A2-N2)
1630 Y1=Q2*SIN(A1)/(A1*COS(A1))
1640 Y2=-SIN(Q2)/COS(Q2)
1650 S=(Y1-Y2)^2
1660 RETURN
1670 REM END SEARCH
1680 A2=A1^2
1690 IF N>A1 THEN G2=N2-A2 ELSE B2=A2-N2
1700 G1=SQR(G2)
1710 B1=SQR(B2)
1720 IF N<A1 THEN GOTO 1760
1730 PRINT"G1= ";
1740 PRINT USING "##.###";G1
1750 GOTO 1780
1760 PRINT"B1= ";
1770 PRINT USING "##.###";B1
1780 PRINT
2000 REM CALCULATION OF PSI
2010 PRINT"--CALCULATION OF PSI--"
2020 PRINT
2030 REM CHOICE OF OUTPUT
2040 PRINT"DO YOU WANT OUTPUT AS TABLE OF VALUES (1) OR IN GRAPHICAL FORM (2)?"
2050 PRINT"ENTER A 1 OR 2"
2060 INPUT Z9
2070 IF Z9=1 THEN GOTO 2090
2080 IF Z9=2 THEN GOTO 2310 ELSE GOTO 2050
2090 REM TABLE OF VALUES
2100 PRINT TAB(9);"TABLE OF VALUES"
2110 PRINT TAB(8);"-----"
2120 PRINT

```

Listing 1 continued on page 43

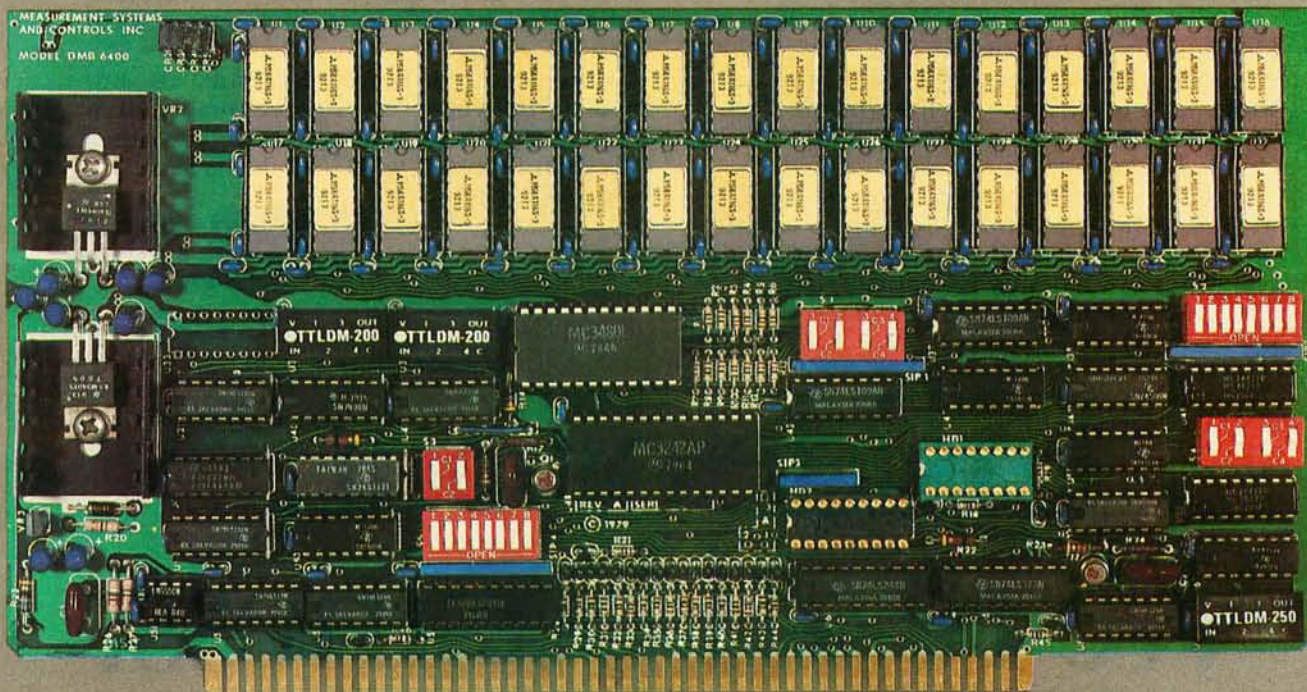

BANK SELECT — 64K BYTE EXPANDABLE MEMORY BOARD

MODEL DMB6400 SERIES
FULLY COMPATIBLE WITH:

**ALPHA MICRO
 CROMEMCO
 NORTH STAR
 MP/M**

and most other
 S-100 systems

- Four independent, 16K software selectable banks.
- Switch selectable bank sizes — from 16K to 64K in 16K increments.
- Eight banks (512K) per I/O port for each of the 256 ports.
- Z-80 4MHz operation with no wait states.
- Low power — 8 watts maximum.
- Reliable, tested and burned-in memory.
- **ONE YEAR GUARANTEE**
- IEEE S-100 compatible timing.
- Attractive Dealer & OEM Prices

MEASUREMENT
 systems & controls
 incorporated

867 North Main Street • Orange, CA 92668
 Telephone: 714/633-4460

You can put our new C8000 microcomputer system to work today. Because while others are talking, we're delivering. *Right off the shelf.*

This powerful general-purpose microcomputer system combines a processor, memory, 8-inch *Winchester* disk and cartridge tape drive into one low-profile desktop package. And the entire 10-Mbyte disk can be backed up on one tape cartridge.

Industry-compatible versions of *BASIC*, *COBOL*, *FORTRAN* and *Pascal* are available on several operating systems, along with communications software, word processing and business applications packages.

When you need to expand the system, you can do it in the field. Just add our forthcoming Z8000* upgrade. Then you can connect eight terminals and link C8000s together. Directly. In a high-speed local network.

More features. Better performance. Immediate delivery. And higher quality than any other unit for the price. To join other successful Onyx OEMs and dealers, call or write us today.



Onyx Systems, Inc.
10575 Bandle Drive
Cupertino, CA 95014
(408) 257-8022

Inside or out, We're all business.



The Onyx C8000

*Z8000 is a registered trademark of Zilog, Inc.

The software you need to sell C8000 microcomputers is available now.

Onyx provides the tools you need to penetrate the business market. Specify either Multi-user OASIS or CP/M 2.0* for an operating system. And select from COBOL, MBASIC, CBASIC II, FORTRAN, Pascal, 2780/3780 Emulator and a CODASYL DBMS.

Choose several popular business and financial applications. These integrated packages include: General Ledger, Accounts Payable, Accounts Receivable, Payroll, Order Entry/Inventory Control. And for the office we have mailing list and word processing systems.

Contact us today about these and other new software products for the Onyx C8000.



Onyx Systems, Inc.
10375 Bandlely Drive
Cupertino, CA 95014
(408) 257-8022

Here's the support
to prove it.



C8000 Software

*CP/M 2.0 is a registered trademark of Digital Research, and CBASIC II is a trademark of Software Systems.

Listing 1 continued:

```

2130 PRINT TAB(4); "A"; TAB(17); "PSI"; TAB(26); "(PSI)^2"
2140 FOR P=-16 TO 0
2150 GOSUB 2610
2160 GOSUB 2830
2170 NEXT P
2180 FOR P=1 TO 16
2190 GOSUB 2680
2200 GOSUB 2830
2210 NEXT P
2220 PRINT
2230 IF F=1 THEN 3000
2240 PRINT "WOULD YOU LIKE TO SEE THE GRAPHICAL FORM?"
2250 PRINT "ENTER A YES OR NO"
2260 F=1
2270 INPUT A$
2280 IF A$="YES" THEN GOTO 2310
2290 IF A$="NO" THEN 3000
2300 GOTO 2250
2310 REM GRAPHICAL FORM
2320 PRINT
2330 PRINT TAB(9); "GRAPHICAL FORM"
2340 PRINT TAB(8); "-----"
2350 PRINT
2360 PRINT TAB(10); "(PSI)^2"
2370 PRINT
2380 FOR A=1 TO 50
2390 PRINT TAB(12+A); "_";
2400 NEXT A
2410 PRINT
2420 FOR P=-16 TO 0
2430 GOSUB 2610
2440 GOSUB 2900
2450 NEXT P
2460 FOR P=1 TO 16
2470 GOSUB 2680
2480 GOSUB 2900
2490 NEXT P
2500 IF F=1 THEN 3000
2510 PRINT
2520 PRINT "WOULD YOU LIKE TO SEE THE TABLE OF VALUES?"
2530 PRINT "ENTER A YES OR NO"
2540 F=1
2550 INPUT A$
2560 IF A$="YES" THEN GOTO 2090
2570 IF A$="NO" THEN 3000
2580 GOTO 2530
2590 PRINT
2600 GOTO 3000
2610 REM SUBROUTINE FOR PSI FROM -16 TO 0
2620 W=P/16
2630 X=W*A
2640 A9=1
2650 P1=A9*SIN(A1*(X+A)/A)
2660 P2=P1^2
2670 RETURN
2680 REM SUBROUTINE FOR PSI FROM 0 TO 16
2690 W=P/16
2700 X=W*A
2710 IF N>A1 THEN GOTO 2720 ELSE GOTO 2790
2720 D=A9*SIN(A1)
2730 C=-D*(EXP(G1)+EXP(-G1))/(EXP(G1)-EXP(-G1))
2740 E5=EXP(G1*X/A)
2750 E6=EXP(-G1*X/A)
2760 P1=C*(E5-E6)/2+D*(E5+E6)/2
2770 P2=P1^2

```

Listing 1 continued on page 44

Listing 1 continued:

```
2780 GOTO 2820
2790 B=A9*SIN(A1)/SIN(B1)
2800 P1=B*SIN(B1*(A-X)/A)
2810 P2=P1^2
2820 RETURN
2830 REM SUBROUTINE FOR TABLE OF VALUES
2840 PRINT USING "##.###";W;
2850 PRINT TAB(14);
2860 PRINT USING " #.###";P1;
2870 PRINT TAB(26);
2880 PRINT USING " #.###";P2
2890 RETURN
2900 REM SUBROUTINE FOR GRAPHICAL FORM
2910 P9=INT(50*P2)
2920 PRINT TAB(5);
2930 PRINT USING"##.###";W;
2940 PRINT "1";
2950 FOR F9=0 TO P9
2960 IF F9+13<>13 THEN PRINT TAB(F9+13);"=";
2970 NEXT F9
2980 PRINT
2990 RETURN
3000 REM CONTINUE OR FINISH
3010 PRINT : PRINT
3020 PRINT"WOULD YOU LIKE TO STUDY ANOTHER PAIR OF ELEMENTS?"
3030 PRINT"ENTER A YES OR NO"
3040 INPUT A$
3050 IF A$="YES" THEN 190
3060 IF A$<>"NO" THEN 3030
3070 END
```

Text continued from page 37:

single function, ψ , must describe a single particle. Thus at the junction of the two sides of the well, the solution for the left side must take on the same value as the solution for the right side:

$$\psi_L = \psi_R \text{ at } x = 0$$

- In addition, the solutions for the left and the right sides must fit together smoothly at the junction of the two sides.

Mathematically, this fourth requirement is met if the first derivatives of the solutions for the left and the right sides of the well take on the same value at the junction:

$$\frac{d\psi_L}{dx} = \frac{d\psi_R}{dx}$$

at $x = 0$.

There is a further complication in the solution for the right side of the potential well. Two cases must be distinguished. The total energy of the

electron, E , may be greater than the potential difference between the elements, V_0 , or E may be less than V_0 . According to classical theory, if E were less than V_0 , the electron would never be able to pass into the region of the bond that is represented by the upper level of the potential well. But such is not the case in quantum mechanics.

Because of the wave-like nature exhibited by submicroscopic particles, it is possible for an electron to enter an area where its total energy is less than the potential of that area. If $E > V_0$, ψ_R is a sine function designated $\psi_{R,i}$ similar in form to the solution for the left side of the potential well. But if $E < V_0$, then ψ_R is a linear combination of hyperbolic functions designated $\psi_{R,ii}$. The Schrödinger equation and these boundary conditions lead to the equations listed in table 2. The program in listing 1 portrays electron behavior in a chemical bond based on these equations.

Algorithm for Simulation

To simulate the behavior of the

electron in a chemical bond, the program executes the following steps:

1. determine the potential difference, V_0 , between the two elements that make up the molecule
2. determine the bond length, a
3. determine the parameter, n , which is a function of V_0 and a
4. determine αa (where α is equal to the momentum of the particle divided by \hbar when the particle is in the left, low side of the well) by solving the appropriate transcendental equation depending upon whether $E > V_0$ or $E < V_0$
5. determine βa or γa (where β and γ correspond to α , but for the right, high side of the well) depending upon whether $E > V_0$ or $E < V_0$
6. determine the coefficients B or C and D in terms of A depending upon whether $E > V_0$ or $E < V_0$
7. evaluate ψ_L and, depending upon whether $E > V_0$ or $E < V_0$, evaluate either $\psi_{R,i}$ or $\psi_{R,ii}$
8. list the values of ψ and ψ^2 in tabular form or display ψ^2 in graphical form



Break out with our breakthrough!

Give your small computer a UDS 103-LP modem for less than \$200

End your isolation. Talk to the rest of the world. Add a UDS 103-LP modem to your personal or small business computer system and you'll have access to the whole dial-up telephone network.

You can communicate with time-sharing services, fellow computer buffs or the larger systems of your customers and suppliers. And, thanks to our breakthrough, the investment is less than \$200.

You get a fully Bell-compatible, originate only, Model 103 modem. It offers full duplex communications capability at any speed from 0 to 300 bps. It fits right under your phone, is FCC certified for direct connection to the telephone network and requires no AC power source. All required operating power comes directly from the phone line itself.

Break out now by getting full details.
Contact Universal Data Systems,
5000 Bradford Drive, Huntsville, AL 35805.
Telephone 205/837-8100.
TWX 810-726-2100.

Patent Applied For

Member IDCMA

"Confidence in Communications"

Universal Data Systems



Table 2: Equations and definitions for solving Schrödinger's equation. The author is indebted to Lars Melander for the potential-well model described in this article and the equations listed in this table. For a complete description of the problem and its solution see Melander's article "Rectangular Box Model of the Polar Bond" in the Journal of Chemical Education, October 1972, pages 686 thru 688. Melander's article was the inspiration for the program of listing 1.

$$\mathbf{A} \quad \frac{d^2\psi}{dx^2} = \frac{-2mE\psi}{\hbar^2} = -\alpha^2\psi; \psi_L = A \sin(\alpha(x+a))$$

The Schrödinger equation and its solution for the left side of the potential well. The solution can be verified by differentiating ψ_L twice.

$$\mathbf{B} \quad \text{i) } \frac{d^2\psi}{dx^2} = \frac{-2m(E - V_0)\psi}{\hbar^2} = -\beta^2\psi; \psi_{R,i} = B \sin(\beta(a - x)) \text{ for } E > V_0$$

$$\text{ii) } \frac{d^2\psi}{dx^2} = \frac{2m(V_0 - E)\psi}{\hbar^2} = \gamma^2\psi; \psi_{R,ii} = C \sinh(\gamma x) + D \cosh(\gamma x) \text{ for } E < V_0$$

The Schrödinger equations and their solutions for the right side of the potential well. There are two possible solutions depending upon whether E is greater than or less than V_0 . The solutions can be verified by differentiating ψ_R twice.

$$\mathbf{C} \quad n^2 = \frac{2mV_0a^2}{\hbar^2}$$

Definition of n , a parameter which is a function of V_0 and a . It is introduced for reasons of convenience.

$$\mathbf{D} \quad \text{i) } \beta^2a^2 = \alpha^2a^2 - n^2 \text{ for } E > V_0$$

$$\text{ii) } \gamma^2a^2 = n^2 - \alpha^2a^2 \text{ for } E < V_0$$

Identities that can be verified by combining the appropriate definitions from A, B and C.

$$\mathbf{E} \quad \text{i) } \sqrt{\frac{\alpha^2a^2 - n^2}{\alpha a}} \tan(\alpha a) = -\tan(\sqrt{\alpha^2a^2 - n^2}) \text{ for } E > V_0$$

$$\text{ii) } \sqrt{\frac{n^2 - \alpha^2a^2}{\alpha a}} \tan(\alpha a) = -\tanh(\sqrt{n^2 - \alpha^2a^2}) \text{ for } E < V_0$$

Pair of transcendental equations that derive from the boundary conditions. They determine the value of αa given n . The equation used depends upon whether E is greater than or less than V_0 .

$$\mathbf{F} \quad \text{i) } B = A \sin(\alpha a) / \sin(\beta a) \text{ for } E > V_0$$

$$\text{ii) } C = -D / \tanh(\gamma a) \text{ for } E < V_0$$

$$D = A \sin(\alpha a)$$

Equations which define the coefficients of the solutions for the right side of the potential well in terms of the coefficient (amplitude), A , of the solution for the left side of the potential well. These equations also derive from the boundary conditions.

A small data file is created. The file contains a list of elements capable of forming a diatomic molecule by exchanging or sharing a single electron with another element. The file contains the following information: the chemical symbol of the element, its ionic radius, ionization potential, and electron affinity. [Note: The ionic radius of an element depends upon whether the molecule is a single unit, as in the gas phase, or whether it belongs to a larger group as in the crystalline or solid phase. The crystalline ionic radii used in this program may be found in the Handbook of Chemistry and Physics, Chemical Rubber Company, 18901 Cranwood Parkway, Cleveland OH 44128.]

The program lists the elements by

name and symbol after a short introduction. The operator enters the symbols for the two elements to be involved in the bond. The program determines potential energy, V_0 , and the bond length, a , then solves for and prints out the parameter, n . Then the product of the momentum and the bond length, αa , must be determined. If the diatomic molecule is in a state of lowest energy, the ground state, then αa must lie in the interval between 0 and π .

Theoretically, the best method of solving the appropriate transcendental equation for αa would be to evaluate each side of the equation separately for all values of αa between 0 and π , and find the point at which the two sides of the equation

are equivalent. It is possible for a computer to find the correct value of αa by stepping αa from 0 to π in very small increments. In practice, this is far too time-consuming, especially on a small computer.

The program of listing 1 determines the value of αa in two stages. In the first stage, αa is increased from 0 to π by steps of 0.1. A graph of each side of the transcendental equation is plotted on the same axis. The point where the two lines generated by the two halves of the equation intersect gives a rough approximation to the proper value of αa . The operator then enters the value of αa immediately before the point of intersection. The program begins with this value of αa and increments it in steps of 0.0004. When

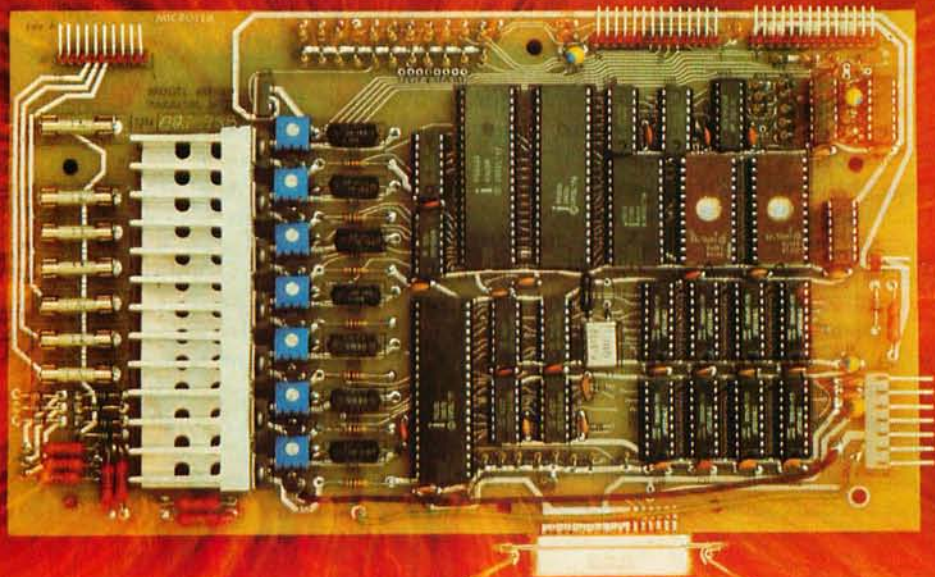

IT'S THE THOUGHT THAT COUNTS

The Microtek MT-80 *looks* like a few other alphanumeric line printers on the market today. But there *is* a difference.

Our versatile, low-cost MT-80 has been designed with a more powerful brain resulting in more advanced features and more dependable performance. We believe our printer is so reliable that we offer you an incredible 365 days warranty.

If you want dependable performance, fast factory service and a low price, look for the Microtek label. The brain behind our printer really makes the difference. It's the thought that counts.

LOADED WITH INNOVATIONS

- 40, 80 or 120 columns (software selectable)
- Non-thermal paper, pin feed
- 125 CPS, 70 lines per minute
- 9 x 7 dot matrix
- Vertical format unit
- 96-character ASCII (upper and lower case)
- Adjustable forms width to 9 1/2"
- Parallel and serial (RS-232C) interfaces available

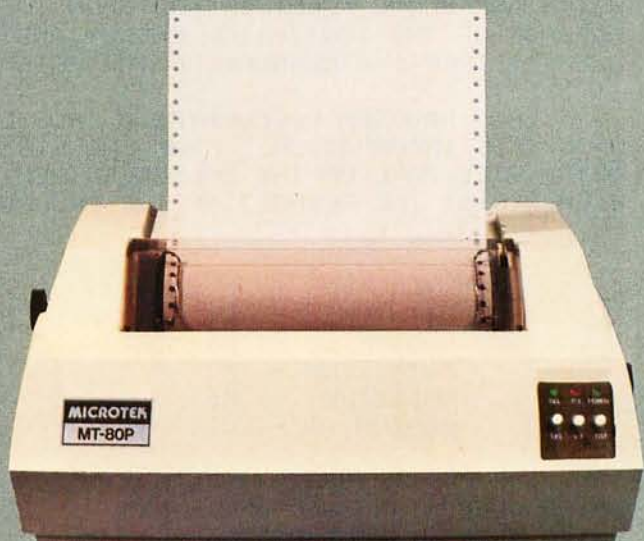

MICROTEK

For more information contact:

MICROTEK, Inc.
9514 Chesapeake Drive
San Diego, CA 92123
Tel. (714) 278-0633

the difference between the two sides of the transcendental equation (squared so that negative numbers are inconsequential) is a minimum, the program prints out the value of αa . Depending upon the relative size of αa and n , the program then evaluates and prints out either βa or γa .

Next the coefficients of the equations for the right side of the potential well are determined in terms of A , the amplitude of the wave equation for the left side of the potential well. The value of the coefficient A could be determined by normalization, making the probability that the electron is at some point between $-a$ and $+a$ equal to 1. In this program, the wave equation is left unnormalized.

The equations defining the relationship among these coefficients are

the result of application of the boundary conditions. Finally, numerical values of ψ and ψ^2 can be determined. The program evaluates ψ for each side of the potential well at fractional intervals along the bond length according to the appropriate equation. The data is available to the operator either in tabular or in graphical form. As might be expected, the graphical form gives a better impression of how the electron behaves in the bond.

Characteristics of the Program

The program of listing 1 was written in AlphaBASIC to run on an AlphaMicro Systems AM-100 computer. The hyperbolic trigonometric functions, $\sinh(x)$ and $\cosh(x)$, do not appear in AlphaBASIC. But these functions can be defined in terms of

the natural exponential function, which appears in most versions of BASIC:

$$\sinh(x) = \frac{e^x - e^{-x}}{2}$$

$$\cosh(x) = \frac{e^x + e^{-x}}{2}$$

In these equations, e is the base of the Napierian natural logarithm and has a value of approximately 2.71828. Otherwise there are no unusual statements or functions in the program. The processing of mathematical variables is carried out in floating-point notation with eleven-digit accuracy.

The formatted output rounds off all results at the third decimal place.

Text continued on page 56

Listing 2: A sample execution of the program of listing 1.

RUM CHMBND

-PROFILE OF A CHEMICAL BOND-

THE ELECTRON DENSITY IN THE CHEMICAL BOND OF A DIATOMIC MOLECULE DEPENDS UPON THE POTENTIAL DIFFERENCE (V_0) BETWEEN THE TWO ELEMENTS WHICH ARE BOUND TOGETHER AND UPON THE LENGTH OF THE BOND (A). THE AVERAGE OF THE IONIZATION ENERGY AND THE ELECTRON AFFINITY OF AN ELEMENT OFFERS A MEASURE OF THE POTENTIAL OF THE ELEMENT.

THIS PROGRAM CALCULATES A PROFILE OF A CHEMICAL BOND BASED UPON THIS INFORMATION. FROM THE LIST OF ELEMENTS BELOW, SELECT TWO WHICH WILL MAKE UP THE MOLECULE. ENTER THE SYMBOLS FOR THESE ELEMENTS AT THE REQUEST OF THE PROGRAM.

HYDROGEN	-	H	FLOURINE	--	F
LITHIUM	-	Li	CHLORINE	-	Cl
SODIUM	-	Na	BROMINE	-	Br
POTASSIUM	-	K	IODINE	-	I
RUBIDIUM	-	Rb			
CESIUM	-	Cs			

ENTER ELEMENT NUMBER ONE - Na
ENTER ELEMENT NUMBER TWO - Cl

$V_0 = 5.743$
 $N = 3.414$

WHEN READY TO CONTINUE TYPE A CARRIAGE RETURN.

GRAPHICAL SOLUTION OF
TRANSCENDENTAL EQUATION

Listing 2 continued on page 50

Listing 2 continued:

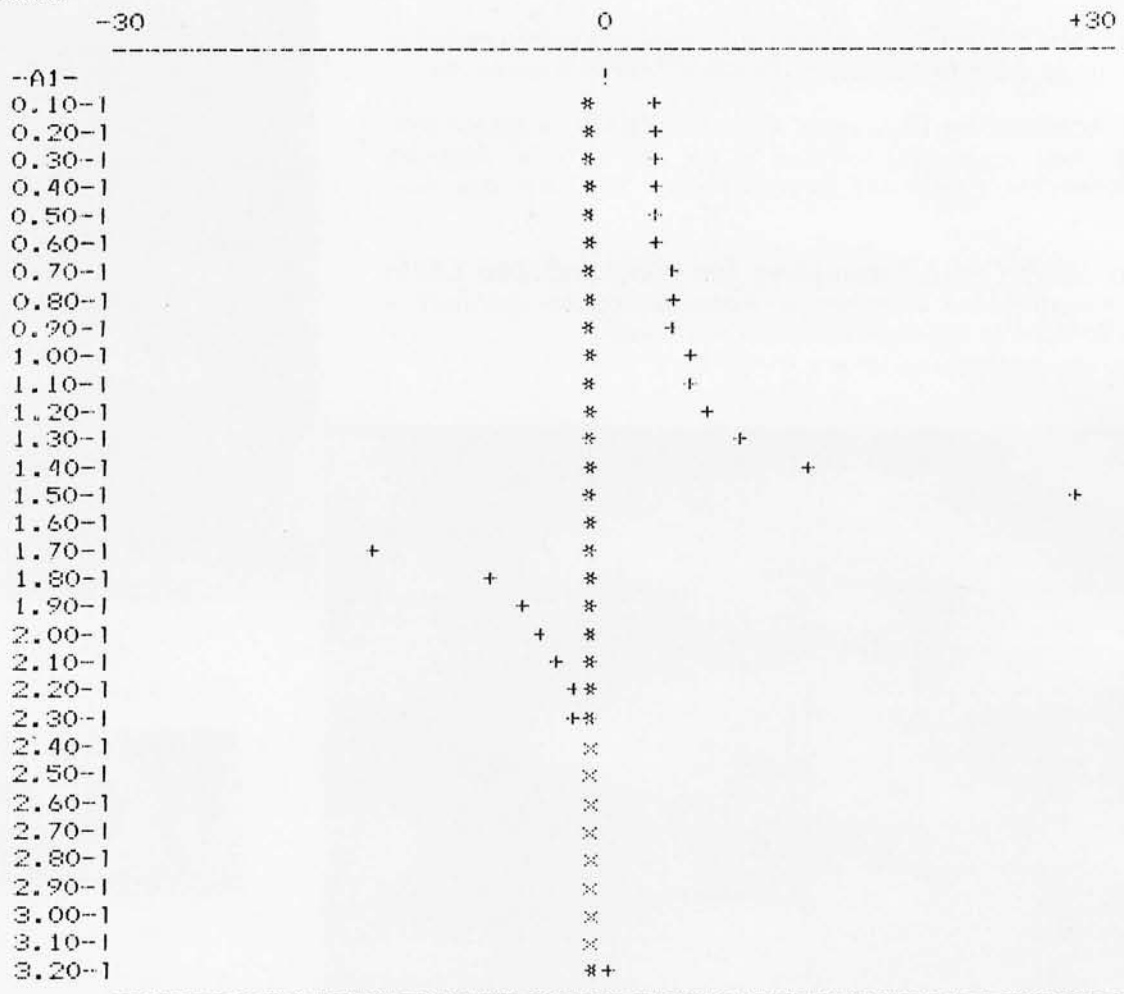

AT WHAT VALUE OF A1 DO THE LINES SEEM TO INTERSECT?
A1 = ? 2.3

THE POINT OF INTERSECTION IS:
A1 = 2.378
G1 = 2.449

-CALCULATION OF PSI -

DO YOU WANT OUTPUT AS TABLE OF VALUES (1) OR IN GRAPHICAL FORM (2)?
ENTER A 1 OR 2
? 1

TABLE OF VALUES

A	PSI	(PSI) ²
-1.000	0.000	0.000
-0.938	0.148	0.022
-0.875	0.293	0.086
-0.813	0.431	0.186
-0.750	0.560	0.314
-0.688	0.677	0.458
-0.625	0.778	0.606
-0.563	0.863	0.744
-0.500	0.928	0.861

Listing 2 continued on page 52

Now...

You, the small systems user can enjoy the advantages of HI-performance *low cost* computer graphics

HIPLLOT™ Digital Plotters

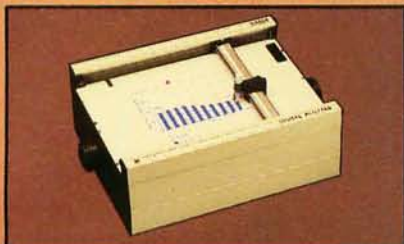

The perfect small system output device

- Displays data in easy to read graphical format
- Both serial and parallel inputs built-in.
- Used standard 8½" x 11" paper (DIN A4)
- Plotting speed up to 2.4 ips (60 mm per sec)
- Resolution of both 0.01 and 0.005 in. (0.1 mm and 0.2 mm)
- Baud rate and step size easily changed
- Completely assembled and ready to use
- Priced at \$1085*

HIPAD™ Digitizers



The perfect small system input device

- Resolution and repeatability of 0.005 in. (0.1 mm)
- Origin is completely relocatable
- RS232C and 8 bit parallel interface selectable at the connector
- Accuracies of ±0.015 in. (0.4 mm)
- Optional LC display shows actual values being inputted
- Digitizing surface 11" x 11" (28 mm x 28 mm)
- Priced at \$795*

For complete information contact Houston Instrument, One Houston Square, Austin, Texas 78753. (512)837-2820. For rush literature requests persons outside Texas call toll free 1-800-531-5205. In Europe contact Houston Instrument, Rochesterlaan 6, 8240 Gistel Belgium. Phone 059/27 74 45.

houston instrument DIVISION OF BAUSCH & LOMB

"the graphics - recorder company"

HIPLLOT-Circle Inquiry #292

HIPAD-Circle Inquiry #293

TM Trademark of Houston Instrument
*U.S. Domestic Price Only

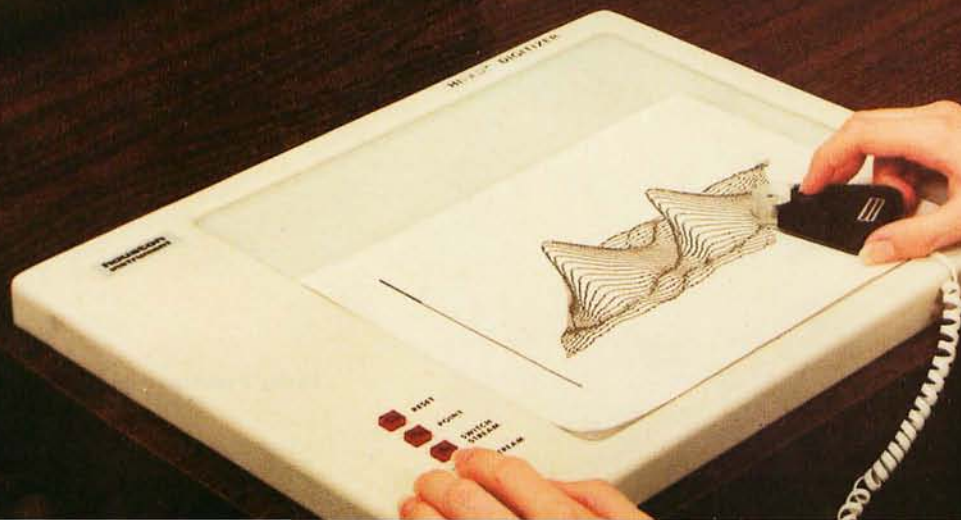
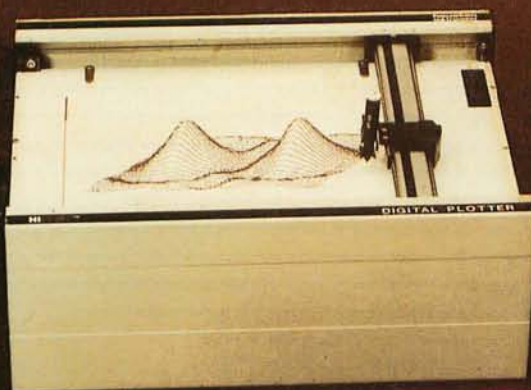

Listing 2 continued:

-0.438	0.973	0.947
-0.375	0.996	0.993
-0.313	0.998	0.996
-0.250	0.977	0.955
-0.188	0.935	0.875
-0.125	0.872	0.761
-0.063	0.790	0.625
0.000	0.691	0.477
0.063	0.591	0.350
0.125	0.506	0.256
0.188	0.432	0.186
0.250	0.368	0.135
0.313	0.313	0.098
0.375	0.265	0.070
0.438	0.223	0.050
0.500	0.187	0.035
0.563	0.155	0.024
0.625	0.127	0.016
0.688	0.101	0.010
0.750	0.078	0.006
0.813	0.057	0.003
0.875	0.037	0.001
0.938	0.018	0.000
1.000	0.000	0.000

WOULD YOU LIKE TO SEE THE GRAPHICAL FORM?
ENTER A YES OR NO
? YES

GRAPHICAL FORM

(PSI)^2



Listing 2 continued on page 54

Chief Relief

For years many small business system buyers thought that in order to get "real" performance and enough storage to be a "real" business system they would have to sacrifice the family jewels.

But with the introduction of the Smoke Signal Chieftain series office computers a lot of people's minds have been changed.

Because we designed the highly reliable Chieftain small business system with the most innovative combination of performance and efficiency around.

At your fingertips there are 64,000 characters of random access memory and you can address anywhere from 740,000 characters to 2 million characters with Smoke Signal's new double density controller. For larger concerns, there's a 20M byte hard disk available.

At a time when other small computer manufacturers tell you "you're on your own", Smoke Signal offers an abundance of easy-to-use software programs such as order entry, inventory control,

accounts receivable, invoice entry, payroll, word processing and much, much more. There's BASIC, COBOL and FORTRAN — even a multi-user BOS (Business Operating System) that allows for numerous users simultaneously.

Chieftain systems starting at under \$200.00 per month display performance on par with systems costing twice to three times as much.

So call (213) 889-9340 for your nearest authorized Smoke Signal dealer — he'll be glad to demonstrate the Chieftain's high reliability and ease of operation.



For dealers only, circle 24

All other inquiries, circle 7

SMOKE SIGNAL



BROADCASTING

31336 Via Colinas, Westlake Village, California 91361, (213) 889-9340



Listing 2 continued:

WOULD YOU LIKE TO STUDY ANOTHER PAIR OF ELEMENTS?
ENTER A YES OR NO
? YES

HYDROGEN	-	H			
LITHIUM	-	Li	FLOURINE	-	F
SODIUM	-	Na	CHLORINE	-	Cl
POTASSIUM	-	K	BROMINE	-	Br
RUBIDIUM	-	Rb	IODINE	-	I
CESIUM	-	Cs			

ENTER ELEMENT NUMBER ONE - H
ENTER ELEMENT NUMBER TWO - I

V0 = 0.439
N = 1.270

WHEN READY TO CONTINUE TYPE A CARRIAGE RETURN.

GRAPHICAL SOLUTION OF
TRANSCENDENTAL EQUATION

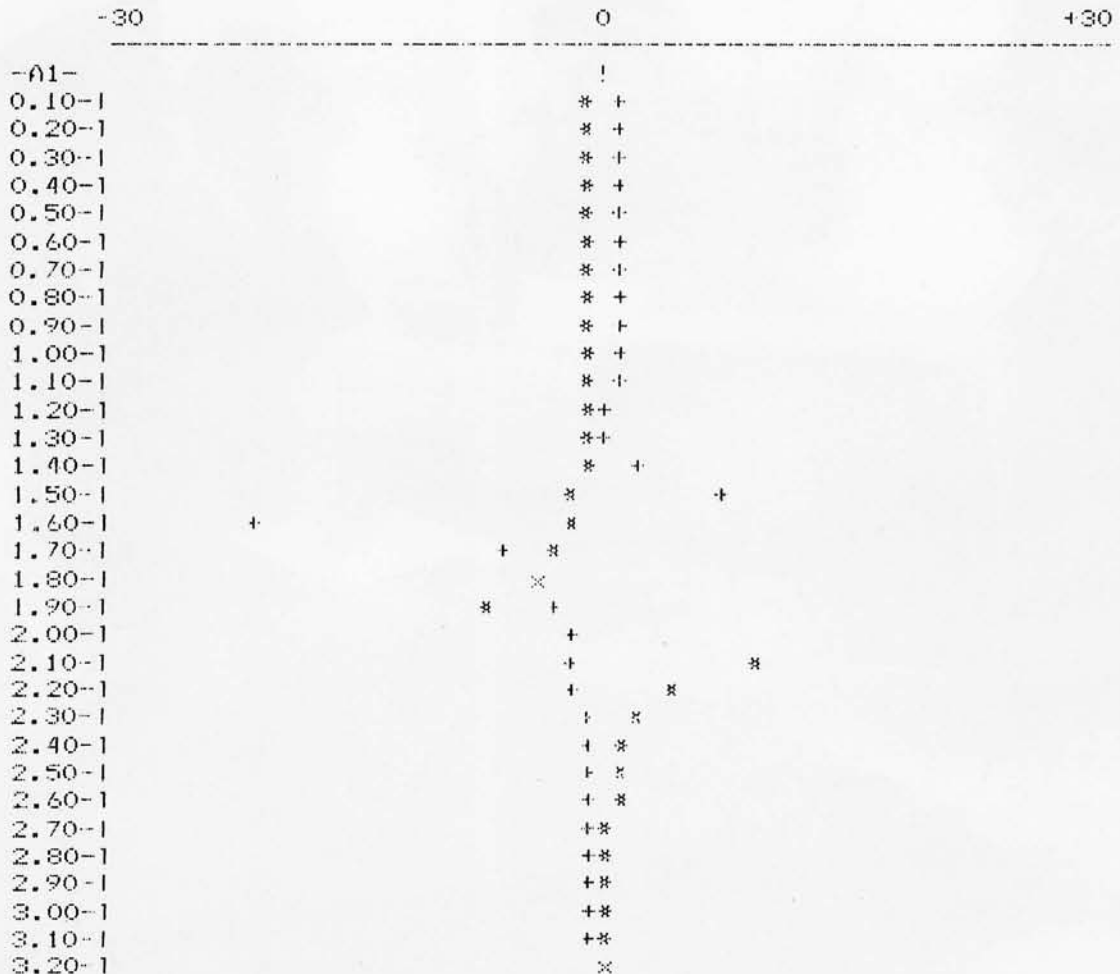

Listing 2 continued on page 56

26 MEGABYTES

\$4995.



DRIVE A HARD BARGAIN!

Suddenly, S-100 microcomputer systems can easily handle 100 million bytes. Because Morrow Designs™ now offers the first 26 megabyte hard disk memory for S-100 systems—the DISCUS M26™ Hard Disk System.

It has 26 megabytes of useable memory (29 megabytes unformatted). And it's expandable to 104 megabytes.

The DISCUS M26™ system is delivered complete—a 26 megabyte hard disk drive, controller, cables and operating system—for just \$4995. Up to three additional drives can be added, \$4495 apiece.

The DISCUS M26™ system features the Shugart SA4008 Winchester-type sealed media hard disk drive, in a handsome metal cabinet with fan and power supply.

The single-board S-100 controller incorporates intelligence to supervise all data transfers, communicating with the CPU via three I/O ports (command, status, and data). The controller has the ability to generate interrupts at the completion of each command to increase system throughput. There is a 512 byte sector buffer on-board. And each sector can be individually write-protected for data base security.

The operating system furnished with DISCUS M26™ systems is the widely accepted CP/M* 2.0.

See the biggest, most cost-efficient memory ever introduced for S-100 systems, now at your local computer shop. If unavailable locally, write Morrow Designs™, 5221 Central Avenue, Richmond, CA 94804. Or call (415) 524-2101, weekdays 10-5 Pacific Time.

*CP/M is a trademark of Digital Research.

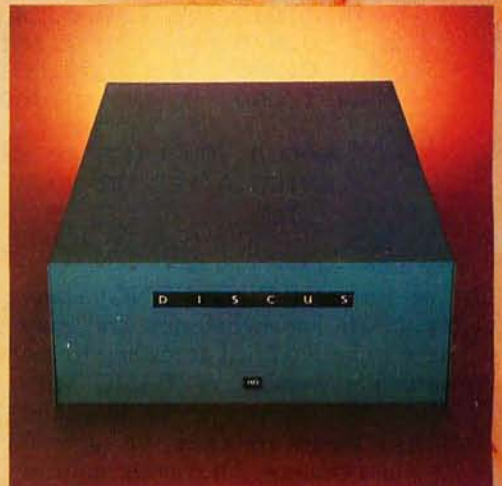
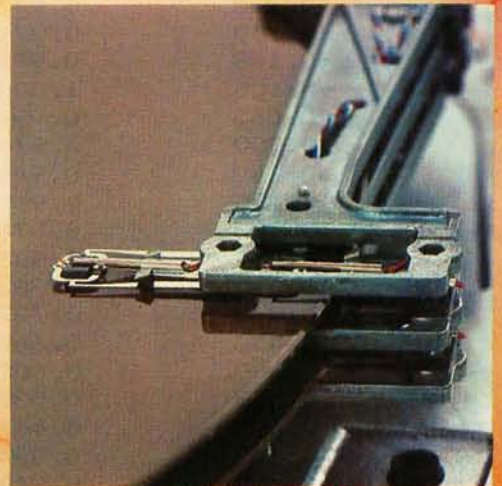

MORROW DESIGNS™
Thinker Toys™

Circle 25 on inquiry card.

Listing 2 continued:

AT WHAT VALUE OF A1 DO THE LINES SEEM TO INTERSECT?

A1 = ? 1.70

THE POINT OF INTERSECTION IS:

A1 = 1.791

B1 = 1.264

-CALCULATION OF PSI-

DO YOU WANT OUTPUT AS TABLE OF VALUES (1) OR IN GRAPHICAL FORM (2)?

ENTER A 1 OR 2

? 1

TABLE OF VALUES

A	PSI	(PSI)^2
-1.000	0.000	0.000
-0.938	0.112	0.012
-0.875	0.222	0.049
-0.813	0.330	0.109
-0.750	0.433	0.188
-0.688	0.531	0.282
-0.625	0.622	0.387
-0.563	0.706	0.498
-0.500	0.781	0.610
-0.438	0.846	0.715
-0.375	0.900	0.810
-0.313	0.943	0.889
-0.250	0.974	0.949
-0.188	0.993	0.987
-0.125	1.000	1.000
-0.063	0.994	0.988
0.000	0.976	0.952
0.063	0.948	0.899
0.125	0.915	0.837
0.188	0.876	0.767
0.250	0.831	0.691
0.313	0.782	0.611
0.375	0.727	0.529
0.438	0.668	0.446
0.500	0.605	0.366
0.563	0.538	0.289
0.625	0.467	0.218
0.688	0.394	0.155
0.750	0.318	0.101
0.813	0.240	0.058
0.875	0.161	0.026
0.938	0.081	0.007
1.000	0.000	0.000

WOULD YOU LIKE TO SEE THE GRAPHICAL FORM?

ENTER A YES OR NO

? YES

Listing 2 continued on page 58

Text continued from page 48:

The format (PRINT USING) statements are somewhat rare and may have to be modified according to the particular version of BASIC with which you happen to be working. The program requires no special graphics systems. All graphic features are generated by using terminal keyboard symbols (such as the asterisk).

Uses of the Program

The program can be easily adapted for further study of chemical bonds in diatomic molecules. You can study the electron distribution for different bond lengths at a constant potential difference. Alternately, you could study the electron distribution for varying potential differences at a constant bond length.

It is also possible to estimate the ionic character of the bond. If the potential difference between two elements was infinitely large, the electron would be confined indefinitely to the lower side of the potential well. The most probable electron location in a symmetrical well would be at the center of the well, in this case at $x = -0.5a$. Since one nucleus would



Color communicates better. That's the *obvious* benefit of ISC's new CP/M[®]2 compatible desktop computer.

What isn't as obvious is the benefit of the CP/M2 operating system. CP/M2 allows Intecolor[®] 8963 users to choose from an abundance of software. The wide variety of business programs available in CP/M greatly reduces the need for specially-prepared software.

Simply load the CP/M2 operating system disk to run any CP/M program (without modification), whether it's in BASIC, COBOL, FORTRAN IV, or any other programming language. Add the superb readability and improved comprehension of color graphics and you've got unparalleled desktop performance.

The Intecolor 8963 is complete with 19" display, 32K of user RAM, 591K dual 8" floppy disk drive, CP/M2 operating system and a color version of Microsoft[®] Business BASIC. At just \$6395,* it's perfect for the small business.

See the new 8963 at selected computer dealers. Or ask your ISC sales representative for a demonstration and find out how color—and CP/M2—can work to your advantage.

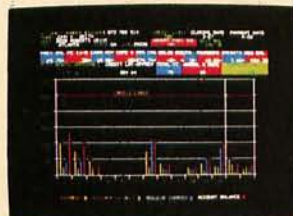
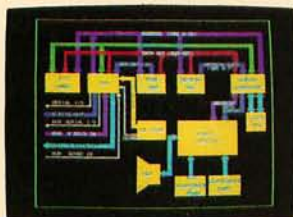

*U.S. domestic price.

Unretouched photo of screen.

CP/M is a registered trademark of Digital Research Corp.

ISC SALES REPRESENTATIVES: AL: 205/883-8660, AZ: 602/994-5400, AR: (TX) 214/661-9633, CA: Alhambra 213/281-2280, Goleta 805/964-8751, Irvine 714/557-4460, Los Angeles 213/476-1241, Los Altos 415/948-4563, San Diego 714/292-8525, CO: 303/779-0666, CT: 203/624-7800, DE: (PA) 412/922-5110, DC: (VA) 703/569-1502, FL: Ft. Lauderdale 305/776-4800, Melbourne 305/723-0766, Orlando 305/425-5505, Tallahassee 904/878-6642, GA: Atlanta 404/455-1035, HI: 808/524-8633, ID: (UT) 801/973-7969, IL: (No.) 312/564-5440, (So. MO) 816/765-3337, IN: (IL) 312/564-5440, IA: (MO) 816/765-3337, KS: (MO) 816/765-3337, KY: 606/273-3771, LA: 504/626-9701, ME: (MA) 617/729-5770, MD: (VA) 703/569-1502, MA: 617/729-5770, MI: Brighton 313/227-7067, Grand Rapids 616/393-9839, MN: 612/822-2119, MS: (AL) 205/883-8660, MO: 816/765-3337, MT: (CO) 303/779-0666, NB: (MO) 816/765-3337, NH: (MA) 617/729-5770, NJ: (No.) 201/224-6911, (So.) 215/542-9876, NV: (AZ) 602/994-5400, NM: 505/292-1212, NY: Metro/LI (No.) 201/224-6911, N. Syracuse 315/699-2651, Fairport 716/223-4490, Ulica 315/732-1801, NC: 919/882-2389, ND: (MN) 612/822-2119, OH: Cleveland 216/398-0506, Dayton 513/429-9040, OK: (TX) 214/661-9633, OR: 503/620-5800, PA: (E) 215/542-9876, (W) 412/922-5110, RI: (MA) 617/729-5770, SC: 803/798-8070, SD: (MN) 612/822-2119, TN: 615/482-5761, TX: Austin 512/454-3579, Dallas 214/661-9633, El Paso Area (Las Cruces, NM) 505/523-0601, Houston Only 713/780-2511, UT: 801/973-7969, VT: (MA) 617/729-5770, VA: 703/569-1502, WA: 206/455-9180, WV: (PA) 412/922-5110, WI: (IL) 312/564-5440, WY: (CO) 303/779-0666, **EUROPEAN EXPORT SALES:** EUROPE: (MA) 617/661-9424, BELGIUM: Brussels 02-242-36-04, FRANCE: Rueil Malmaison 749-40-37, GREECE: Athens 642-1368, ITALY: Milano 02600733, WEST GERMANY: Koblenz (0261)-31025/6, AUSTRALIA & NEW ZEALAND: Auckland 814-9385, Canberra 58-1811, Chermside 59-6436, Melbourne 03-543-2077, Sydney 02-808-1444, Wellington 64-4585, CANADA: Dorval 514/636-9774, Ottawa 613/224-1391, Toronto 416/787-1208, Vancouver 604/684-8625, **CENTRAL AND SOUTH AMERICA & CARIBBEAN:** (GA) 404/394-9603, **MEXICO:** Monterrey 564-876, **FAR EAST:** (CA) 213/382-1107, **HONG KONG:** 5-742211, **JAPAN:** (Tokyo) (03) 463-9231, **TAIWAN:** (Taipei) 02-7026284, **MIDDLE EAST:** (GA) 404/581-0284, **ISRAEL:** Ramat Gan 03725749, **KUWAIT:** Kuwait 438-180/1/2, **LEBANON:** Beirut 221731/260110, **SAUDI ARABIA:** Jeddah 27790, Riyadh 25083-39792.

For sales and service in other countries contact ISC headquarters in Norcross, GA, U.S.A.



Intelligent Systems Corp. Intecolor Drive • Technology Park/Atlanta • Norcross, GA 30092 • Telephone 404/449-5961 • TWX 810-766-1581

Circle 26 on inquiry card.

(PS1)^2

```

-----
-1.0001
-0.9381
-0.8751 ==
-0.8131 =====
-0.7501 =====
-0.6881 =====
-0.6251 =====
-0.5631 =====
-0.5001 =====
-0.4381 =====
-0.3751 =====
-0.3131 =====
-0.2501 =====
-0.1881 =====
-0.1251 =====
-0.0631 =====
0.0001 =====
0.0631 =====
0.1251 =====
0.1881 =====
0.2501 =====
0.3131 =====
0.3751 =====
0.4381 =====
0.5001 =====
0.5631 =====
0.6251 =====
0.6881 =====
0.7501 =====
0.8131 ==
0.8751 =
0.9381
1.0001
    
```

WOULD YOU LIKE TO STUDY ANOTHER PAIR OF ELEMENTS?
 ENTER A YES OR NO
 ? NO

have exclusive possession of the electron, such a bond would be 100% ionic.

If there was *no* potential difference between the two elements, the most probable location in the symmetrical well would again be the center of the well, but this time at $x = 0$. The bond has 0% ionic character.

All real molecular bonds lie between these two extremes. To estimate the ionic character of a bond, search for the fractional value of the bond length at which the probability distribution curve has maximum amplitude. Multiply this number by two, make it positive, and convert it to a percentage form. The result is a model estimate of the ionic

character of the bond.

This program represents a mere peek at the quantum mechanical world of atoms and molecules. Much has been discovered and much remains to be discovered. The computer facilitates investigation of this world. Moreover, the computer can be a spur to our imagination beckoning us to new vistas in the microscopic world and beyond. ■

Bibliography

1. Arya, Atam P, *Elementary Modern Physics*, Addison-Wesley Publishing Company, Reading MA, 1974.
2. Blanchard, C H, *et al*, *Introduction to Modern Physics*, Prentice-Hall Inc, Englewood Cliffs NJ, 1969.

3. Ford, Kenneth W, *Classical and Modern Physics*, Volume 3, A Textbook for Students of Science and Engineering, John Wiley and Sons, New York, 1974.
4. French, A P and Taylor, Edwin F, *An Introduction to Quantum Physics*, The MIT Introductory Physics Series, W W Norton and Company Inc, New York, 1978.
5. Goble, Alfred T and Baker, David K, *Elements of Modern Physics*, The Ronald Press Company, New York, 1962.
6. *Handbook of Chemistry and Physics*, The Chemical Rubber Publishing Company, Cleveland OH.
7. Kim, S K and Strait, E N, *Modern Physics for Scientists and Engineers*, Macmillan Publishing Company Inc, New York, 1978.
8. Melander, Lars, "Rectangular Box Model of the Polar Bond," *Journal of Chemical Education*, October, 1972, pages 686 thru 688.
9. Pauling, Linus, *The Chemical Bond*, Cornell University Press, Ithaca NY, 1967.
10. Strauss, Herbert L., *Quantum Mechanics: An Introduction*, Prentice-Hall Inc, Englewood Cliffs NJ, 1968.



Let this New Series from **BYTE BOOKS™** answer your programming questions

Programming Techniques is a series of collected articles concerned with the art and science of computer programming. The first volume in the Programming Techniques series is entitled **Program Design**. The purpose of the book is to provide the personal computer user with the techniques needed to design efficient, effective, maintainable programs.

ISBN 0-07-037825-8 Pages: 96
Price: \$6

Editor: Blaise W. Liffick

Simulation is the second volume in the Programming Techniques series. Both theoretical and practical applications are included. Particularly stressed is simulation of motion, including wave motion and flying objects, and the use of simulation for experimentation.

ISBN 0-07-037826-6 Pages: 126
Price: \$6

Editor: Blaise W. Liffick

Numbers in Theory and Practice is the third book in the series. It includes information of value to both the novice and the experienced personal computer user. The mechanics of the binary system are discussed, including software division and multiplication, as well as floating point

numbers, numerical methods, random numbers, and the mathematics of computer graphics.

ISBN 0-07-037827-4 Pages: 192
Price: \$8.95

Editor: Blaise W. Liffick

The 4th volume of the Programming Techniques series, **Bits and Pieces**, covers various topics of interest to programmers. It

is a collection of the best articles from past issues of BYTE magazine plus new material collected specifically for the series, on subjects such as multiprogramming, stacks, interrupts optimization, and real time processing.

ISBN 0-07-037828-2 Pages: 160
Price \$8.95

Editor: Blaise W. Liffick



- Please send _____ copies of Program Design
 _____ copies of Simulation
 _____ copies of Numbers in Theory and Practice
 _____ copies of Bits and Pieces

Name _____ Title _____ Company _____

Street _____ City _____ State/Province _____ Code _____

Check enclosed in the amount of \$ _____

Bill Visa Bill Master Charge

Card No. _____ Exp. Date _____

Add 60¢ per book to cover postage and handling.



70 Main St, Peterborough, NH 03458

Hewlett-Packard's New Personal Computer The HP-85

Christopher P Morgan
Editor-in-Chief

Photos by Ed Crabtree

A question often heard in personal computer circles is, "When is Hewlett-Packard going to bring out a personal computer?" The question has been answered, and the new HP-85 computer is quite a system.

Hewlett-Packard (HP) has long been a respected manufacturer of minicomputers, desktop calculators, and handheld calculators; the high quality of their electronic test equipment is well known to the engineering

community. Hewlett-Packard also has the reputation for being a careful, conservative company, and the HP-85 is, not surprisingly, a logical outgrowth of their desktop and handheld calculators.

We recently had the opportunity to audition the HP-85. Our preliminary findings are listed below.

System Features

The basic HP-85, shown in photo

1, costs \$3250 and consists of a micro-computer with a custom 8-bit processor and several other custom integrated circuits, data cartridge drive for DC-100 tape cartridges, a high-resolution video display with a 5-inch screen (measured diagonally) with resolution of 256 by 192 dots (individually addressable) for graphics, 16 lines by 32 characters of text, keyboard, and thermal printer. The unit comes with 16 K bytes of program-



Photo 1: Hewlett-Packard's new entry into the personal computer market: the HP-85. The \$3250 unit features a 5-inch video display, data cartridge drive, keyboard with user-programmable keys, and thermal printer. The HP-85 also offers interesting graphics capabilities. Every point on the 256 by 192 dot array can be individually addressed by the programmer. The built-in thermal printer can make a copy of any graphic design on the screen or any alphanumeric data. Sophisticated features included in this unit are a hardware and software self-test key; four levels of security protection for files on data cartridges; plug-in memory expansion to the basic package of 16 K bytes of programmable memory and 32 K bytes of read-only memory; ANSI standard Enhanced BASIC with the ability to chain programs together; and line editing.

SuperBrain™

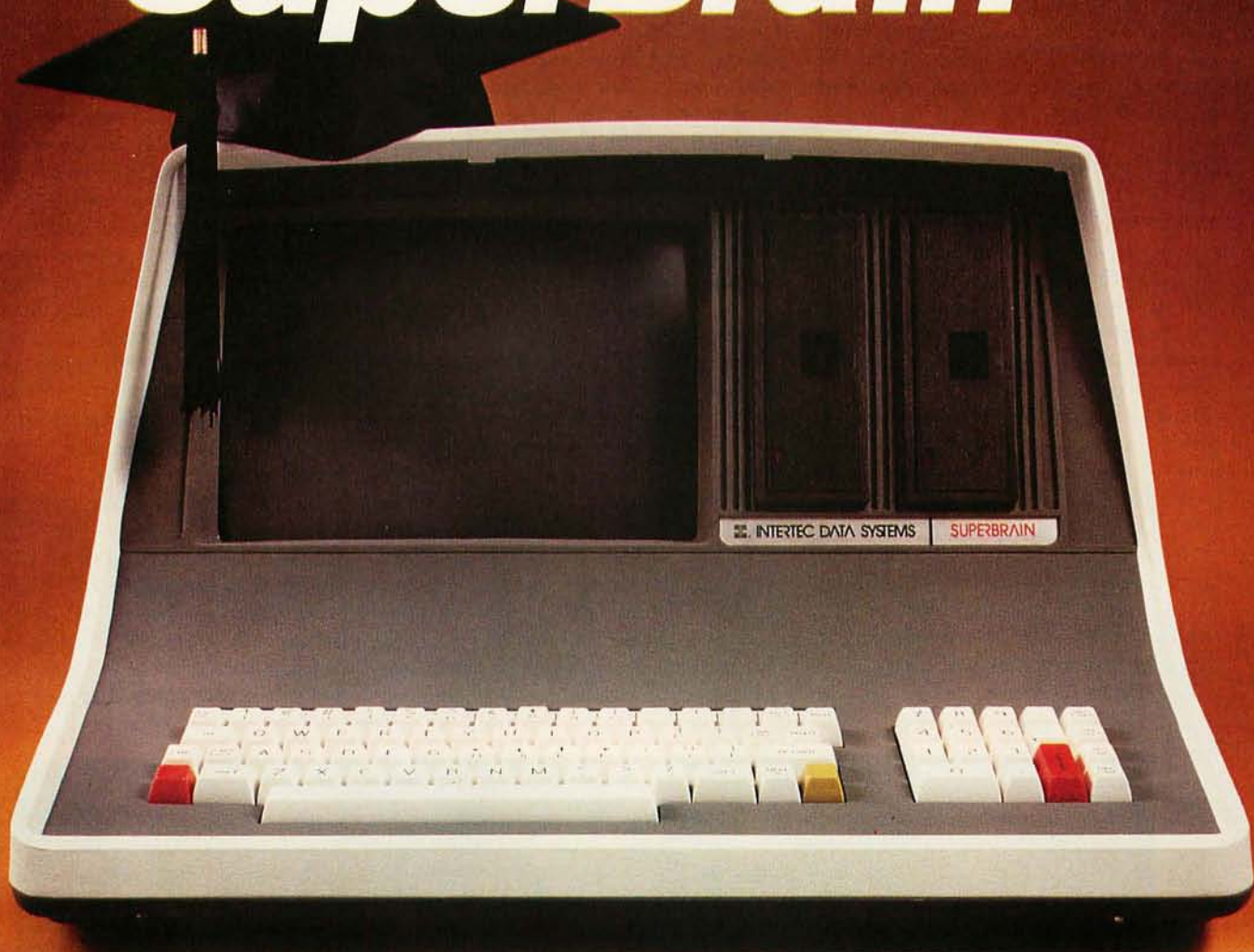

The Honor Graduate

There's been a lot of talk lately about intelligent terminals with small systems capability. And, it's always the same. The systems which make the grade in performance usually flunk the test in price. At least that was the case until the SuperBrain graduated with the highest PPR (Price/Performance Ratio) in the history of the industry.

For less than \$3,000*, SuperBrain users get exceptional performance for just a fraction of what they'd expect to pay. Standard features include: two dual-density mini-floppies with 320K bytes of disk storage, up to 64K of RAM to handle even the most sophisticated programs, a CP/M Disk Operating System with a high-powered text editor, as-

sembler and debugger. And, with SuperBrain's S-100 bus adapter, you can even add a 10 megabyte disk!

More than an intelligent terminal, the SuperBrain outperforms many other systems costing three to five times as much. Endowed with a hefty amount of available software (BASIC, FORTRAN, COBOL), the SuperBrain is ready to take on your toughest assignment. You name it! General Ledger, Accounts Receivable, Payroll, Inventory or Word Processing . . . the SuperBrain handles all of them with ease.

Your operators will praise the SuperBrain's good looks. A full ASCII keyboard with a numeric keypad and function keys. A non-glare, dynamically focused, twelve inch screen. All in an attractive desktop unit weighing less than a standard

office typewriter. Sophisticated users will acclaim SuperBrain's twin Z-80 processors which transfer data to the screen at 38 kilobaud! Interfacing a printer or modem is no problem using SuperBrain's RS-232C communications port. But best of all, you won't need a PhD in computer repair to maintain the SuperBrain. Its single board design makes servicing a snap!

So don't be fooled by all the freshman students in the small systems business. Insist on this year's honor graduate . . . the SuperBrain.



2300 Broad River Road, Columbia, SC 29210
(803) 798-9100 TWX: 810-666-2115

*Quantity one. Dealer inquiries invited.

Circle 28 on inquiry card.

mable memory (14,500 of which are available to the user) expandable to 32 K bytes, and 32 K bytes of read-only memory. The latter contains the operating system and the Enhanced BASIC package.

Data Cartridges

One of the main differences between the HP-85 and most other small systems on the market is its use of data cartridges for reading and writing programs and data. This is not surprising, since the company expects to sell the unit in large quantities to professionals, and the data cartridge is one of the most reliable forms of mass storage available today. The cartridge-drive slot is located on the front of the machine (see photo 1).

Each cartridge can hold 780 program records consisting of 192 K bytes each, or 850 data records of 210 K bytes. There can be a maximum of forty-two named files per cartridge.

Cartridge rewind time is 29

seconds; search speed is 152 cm (60 inches) per second; data transfer speed is 25.4 cm (10 inches) per second; and tape length is 43 meters (141 feet). With the data cartridge system the user can create data files, input arrays into the computer with a single program statement, store an "autostart" program that is automatically loaded and executed at power-on, and secure programs from unauthorized access.

Keyboard

The keyboard is divided by function: the typewriter keyboard for entering alphanumeric data, the numeric pad for entering numeric information, and eight user-definable keys. (These keys are located directly under the video screen. Labels for the keys can be entered by the user and will appear at the bottom of the screen). Display, editing, and system-control keys permit the user to control the video display. The keyboard is hinged and can be easily swung out

of the way after the cover is removed to service the processor board (see photo 3).

Video Display

One of the HP-85's strong points is its graphics and alphanumeric display capability. Sixteen lines of text can be displayed at a time on the screen, but a buffer holds up to sixty-four lines, so the user can back up and see a part of a listing that has scrolled off the screen—a decided convenience in writing or debugging programs. If you come to the end of the sixty-four-line section in the buffer, the display wraps around to the beginning again. Characters are formed in a 5 by 7 dot matrix.

In the graphics mode, the display consists of a 256 (wide) by 192 (high) dot field, giving a total of 49,152 individual dots available for high-resolution plotting. The HP-85 also stores the last alphanumeric display and the last graphics display in separate buffers so the user can switch more freely

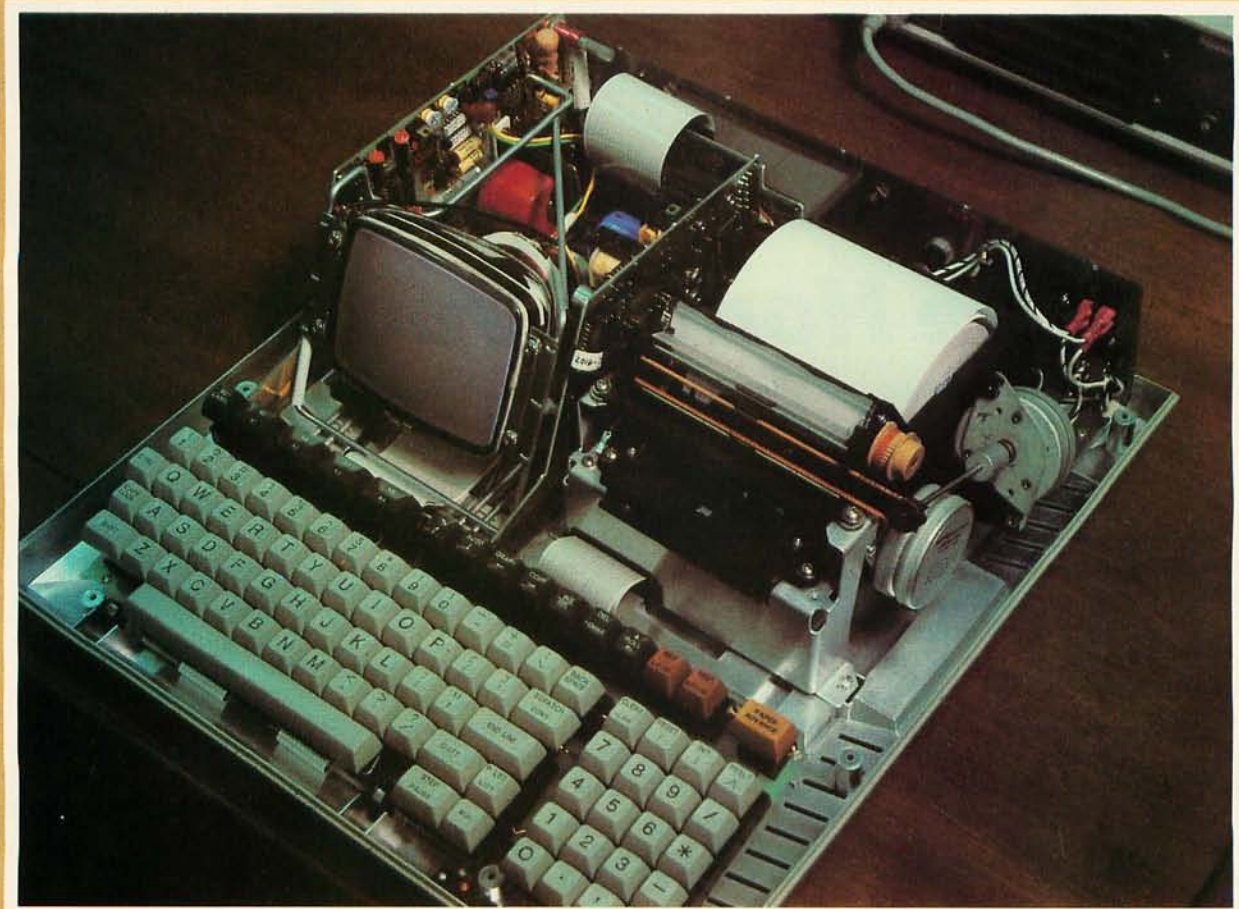

Photo 2: Inside the HP-85, showing the 5-inch video display cathode-ray tube, thermal printer, and data cartridge drive. The processor board is located under the keyboard (see photo 4). Note the set of user-definable keys at upper left of the keyboard. Labels for these keys are displayed at the bottom of the video screen.

MicronET

It's off and running. And delivering as promised.

What is MicroNET?

It is the personal computing service of CompuServe, Incorporated. CompuServe is a nationwide commercial time sharing computer network with large-scale mainframes. MicroNET allows the personal computer user access to CompuServe's large computers, software and disc storage during off-peak hours (from 6 PM to 5 AM weekdays, all day on Saturdays, Sundays and most holidays).

What do I get?

You can use our powerful processors with X-Basic, Fortran, Pascal, Macro-10, AID or APL. You get 128K bytes of storage free (just access it at least once a month). Software includes games—including networking multi-player games—personal, business and educational programs.

In addition, there is the MicroNET National Bulletin Board for community affairs,

for sale and wanted notices and the MicroNET Electronic Mail System for personal messages to other MicroNET users. You can even sell software via MicroNET.

NEW! MicroQUOTE, a security information system for corporate stocks and public debt.

NEW! MicroNET Software Exchange with dozens of new programs available for downloading to your personal computer at a specified charge.

NEW! Executive programs for TRS-80, Apple II and CP/M systems (so your machine and ours can talk to each other error-free). You can switch between terminal and local mode while on line.

What do I have to have to use MicroNET?

The standard 300 baud modem. MicroNET has local phone

service in most major cities (see below) and a reduced phone charge in over a hundred others.

What is the cost?

We've saved the best for last. There is a one-time hook-up charge of only \$9.00! Operating time—billed in minutes to your VISA or MasterCard—is only \$5.00 an hour.

Want more information?

Good. Write to us at the address below. We'll send you a full packet of information about MicroNET.

CompuServe

Personal Computing Division
Dept. B
5000 Arlington Centre Blvd.
Columbus, Ohio 43220

MicroNET is available via local phone calls in the following cities: Akron, Atlanta, Boston, Canton, Chicago, Cincinnati, Cleveland, Columbus, Dallas, Dayton, Denver, Detroit, Houston, Indianapolis, Los Angeles, Louisville, Memphis, West Caldwell (NJ), New York, Philadelphia, Pittsburgh, San Francisco, Stamford (CT), St. Louis, Toledo, Tucson and Washington, D.C.

Access to the MicroNET service is available in 153 other cities for an additional charge of \$4.00 per hour.



"... but the really impressive stuff is in the back room."

from one mode to the other without losing data.

Readers familiar with the company's desktop calculators will be immediately at home with the HP-85's graphics-handling routines. There are sixteen graphics commands for setting up graphs, locating the origin, and scaling and labeling the axes quickly.

Anything that appears on the screen can be printed on the thermal printer by simply pressing the GRAPH and COPY keys in that order. You may also enter commands from the keyboard while in graphics mode. Inverse video is also available, as well as a BPLOT routine for user-defined graphics.

The alphanumeric characters are on the small side compared to the average personal computer display because of the screen size. However, they are quite readable—not unlike the IBM 5100 display. Screen editing is convenient. There are five cursor-

control keys, plus keys for clearing the screen, a line, or a single character. The ability to edit within a program line is a great time saver.

Security

The HP-85 offers unprecedented versatility when it comes to securing data and programs. The SECURE command is used to prevent specific program files from being listed, edited, or stored; to prevent any file's name from appearing in the directory listing; and to protect the user from writing over a file. The UNSECURE command removes security on secured programs or data files. The file name to be secured must already appear in the directory (ie: it must already exist on tape).

The file name may be any string of characters except the null string. The system takes the first two characters of the string and stores them as the security code. There are four levels of security.

At level 0, the program may not be listed or edited. Level 1 further prevents the program from being duplicated. At level 2, the program may also not be overwritten. Level 3 removes the name of the file from the catalog and replaces it with blank.

Printer

The thermal printer operates in both alphanumeric and graphics modes. In the alphanumeric mode, it can print the full 128-character ASCII character set, which includes uppercase and lowercase letters, numerals, and special symbols. The full character set can be underlined. Printer speed is 2 lines per second.

Enhanced BASIC

The HP-85's Enhanced BASIC interpreter meets and exceeds the most recent ANSI standard. Its features include: 12-digit accuracy and exponents up to ± 499 for calculations; extremely versatile

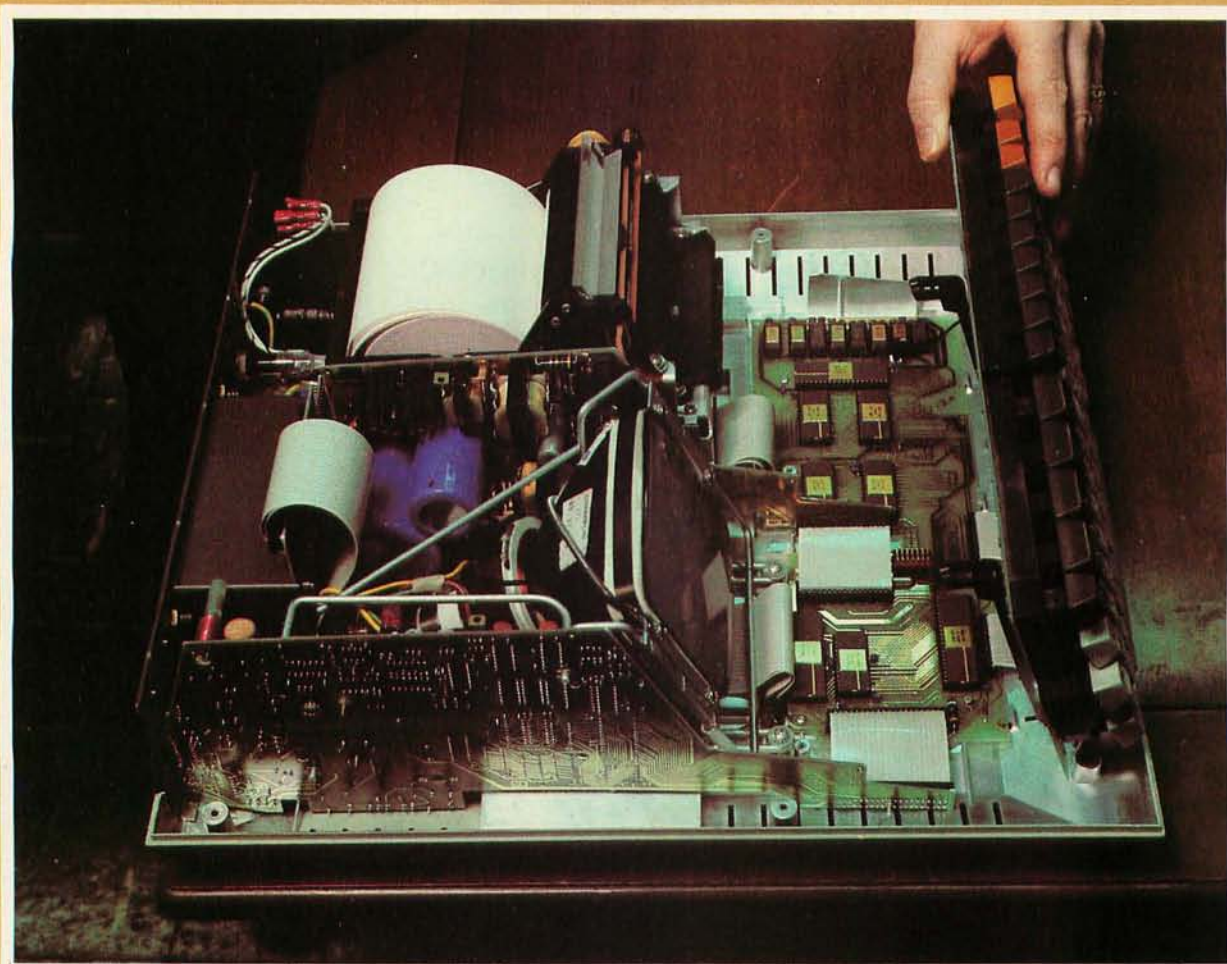

Photo 3: Internal view of the HP-85, showing the processor board under the hinged keyboard. The 8-bit processor is a custom Hewlett-Packard design, as are most of the integrated circuits in the computer.

A COMPUTER ODYSSEY

FREE

No ticket to buy! No parking problems!

FREELAND INTERNATIONAL COMPUTER SHOWS **Hardware*New Products*Systems*Software**

Major manufacturers launch into the 80's in this Computer Odyssey. The newest computer and computer related products are made directly available for demonstration to the end user, the broad spectrum of people—the NOW market. Create computer fever and the demand for more knowledge, service, and products. The NOW market is growing and constantly winning new users—encourage them to examine the unlimited potential. Be there, where they shop and compare in comfortable leisure, with no ticket to buy and no parking problems. The telephone, the television, and now a computer in every home—a goal possible when you step into the 80's with Freeland International Computer Shows.

You are invited. Be there. This is the most important invitation of the 1980's for you and your business.

April 9-13, 1980



THE FABULOUS DAYTON MALL
2700 Miamisburg Centerville Road, Dayton, Ohio
45459 (Intersection Ohio State Rts. 741 & 725, just
off I-75)

For dealer information contact:
FREELAND INTERNATIONAL
COMPUTER SHOWS
2918 Martel Drive
Dayton, Ohio 45420
513/254-2900



*Registered Trademark of
Freeland Shows, Inc.

*Freeland International Computer Shows is a division of FREELAND SHOWS, INC.

string-handling capability (a string in HP-85 Enhanced BASIC can theoretically be up to 32 K bytes long) compatible with string handling on other HP computers; 42 predefined functions; formatted output; the ability to chain BASIC programs together; multistatement lines; a programmable sound generator that can play single-voice lines of melody through the built-in speaker or make audible beeps at predetermined times during the execution of a program; and calculator capability. For debugging, the user can single-step through BASIC programs, branch ON ERROR, or have the program provide a default value with DEFAULT ON to enable a program to continue executing. In particular, the formatted-output capability is useful for generating headings, columns, and spaces for program output.

Self-Test

A unique feature of the HP-85 is the built-in self-test routine. When the TEST key is pressed, the computer runs through an electronic check of all internal components—a

feature common to many Hewlett-Packard electronic instruments. If everything checks out correctly, a particular set of characters is displayed on the screen. (The graphics display will be cleared, but programs and variables in memory will remain intact.) If the system is not operating correctly, the system displays "Error 23 SELF TEST."

Input/Output

Photo 4 shows the back of the HP-85 and the four input/output (I/O) ports. Additional memory can be added via the ports. The company will be introducing a variety of peripherals for the unit, including dual 5-inch floppy-disk drives, external printers, plotters, and so on. An extra 16 K bytes of memory costs \$395.

Software

Software currently available on data cartridges for the HP-85 includes BASIC training, general statistics, mathematics, electrical engineering, finance, linear programming, and regression analysis. Each package costs \$95. More packages are under

development. BASIC program developed for Hewlett-Packard's desktop computers can be adapted for use on the HP-85, as can most programs written in ANSI BASIC. The unit also comes with a well-written, 350-page owner's manual and a standard application software package. Hewlett-Packard is quoting immediate delivery on the HP-85.

Evaluation

We were impressed with the performance of the HP-85 computer. The graphics alone make this an attractive, albeit not inexpensive, alternate to existing small systems on the market. And many of its features are unique. Although Hewlett-Packard is pinning its hopes on heavy sales to the professional marketplace, it is our guess that many personal computer experimenters and hackers will want this machine.

In future issues of BYTE we will evaluate the HP-85 in greater depth.

For further information about the HP-85, contact: Inquiries Manager, Hewlett-Packard Co, 1507 Page Mill Rd, Palo Alto CA 94303. ■



Photo 4: Rear view, showing the four I/O ports and their removable covers.

From PERCOM

One-Drive System:

\$399. (40-track) & \$675. (77-track)

Two-Drive System:

\$795. (40-track drives) & \$1350. (77-track drives)

Three-Drive System:

\$1195. (40-track drives) & \$2025. (77-track drives)

Requires Expansion Interface, Level II BASIC & 16K RAM.



Low Cost Add-On Storage for Your TRS-80* . In the Size You Want.

When you're ready for add-on disk storage, we're ready for you.
Ready with six mini-disk storage systems — 102K bytes to 591K bytes of
additional *on-line* storage for your TRS-80* .

- Choose either 40-track TFD-100™ drives or 77-track TFD-200™ drives.
- One-, two- and three-drive systems immediately available.
- Systems include Percom PATCH PAK #1™, on disk, at no extra charge. PATCH PAK #1™ de-glitches and upgrades TRSDOS* for 40- and 77-track operation.
- TFD-100™ drives accommodate "flippy disks." Store 205K bytes per mini-disk.
- Low prices. A single-drive TFD-100™ costs just \$399. Price includes PATCH PAK #1™ disk.
- Enclosures are finished in system-compatible "Tandy-silver" enamel.

Whether you need a single, 40-track TFD-100™ add-on or a three-drive add-on with 77-track TFD-200™s, you get more data storage for less money from Percom.

Our TFD-100™ drive, for example, lets you store 102.4K bytes of data on one side of a disk — compared to 80K bytes on a TRS-80* mini-disk drive — and 102.4K bytes on the other side, too. Something you can't do with a TRS-80* drive. That's almost 205K bytes per mini-disk.

And the TFD-200™ drives provide 197K bytes of on-line storage per drive

— 197K, 394K and 591K bytes for one-, two and three-drive systems.

PATCH PAK #1™, our upgrade program for your TRSDOS*, not only extends TRSDOS* to accommodate 40- and 77-track drives, it enhances TRSDOS* in other ways as well. PATCH PAK #1™ is supplied with each drive system at no additional charge.

The reason you get more for less from Percom is simple. Peripherals are not a sideline at Percom. Selling disk systems and other peripherals is our main business — the reason you get more engineering, more reliability and more back up support for less money.

In the Product Development Queue . . . a printer interface for using your TRS-80* with any serial printer, and . . . the *Electric Crayon*™ to map your computer memory onto your color TV screen — for games, animated shows, business displays, graphs, etc. Coming PDQ!

™ TFD-100, TFD-200, PATCH PAK and Electric Crayon are trademarks of PERCOM DATA COMPANY.

*TRS-80 and TRSDOS are trademarks of Tandy Corporation and Radio Shack which have no relationship to PERCOM DATA COMPANY.

PERCOM

PERCOM DATA COMPANY, INC.
211 N. KIRBY • GARLAND, TX. • 75042

To order add-on mini-disk storage for your TRS-80* ,
or request additional literature, call Percom's toll-free
number: 1-800-527-1592. For detailed Technical infor-
mation call (214) 272-3421.

Orders may be paid by check or money order, or
charged to Visa or Master Charge credit accounts. Texas
residents must add 5% sales tax.

Percom 'peripherals for personal computing'

Programming Quickies

Gear-Ratio Calculation for Bicycle Derailleurs

John A Lehman, 716 Hutchins, Apt 2, Ann Arbor MI 48103

KERCHUNK! "Hey, what gear is next on this thing?" asked my wife, Lisa. Since my old, reliable three-speed bicycle suffered a close encounter of the worst kind with a car impatient to turn right on a red light, we had both decided to buy used ten-speed bikes. Unfortunately, that meant having to worry about seven more "speeds."

"Why don't you use your computer to figure out what order to do things in?" she asked. This was a good suggestion, especially since one of our neighbors had been wanting me to figure out whether it would be worthwhile for him to change from a five-speed to a ten-speed shift mechanism. The result is this Programming Quickie which describes a program that helps answer these and other questions.

The most popular gear shift mechanism on bicycles these days is the *derailleur*. This mechanism uses one, two, or three front gear sprockets (ie: chain wheels) and either five or six rear gear sprockets. This means that one can have a five-, six-, ten-, twelve-, fifteen-, or eighteen-speed shift mechanism. The derailleur device moves the chain between the different gear sprockets, as shown in figure 1 on page 70. This means that, unlike two- and three-speed bikes, the shift mechanism cannot go directly from low to high gear. Rather, there are as many separate sequences of gear combinations as there are front chain wheels; the rider has to combine these different sequences into one overall shift pattern.

To make things more complicated, there are fairly wide variations in the number of gear teeth on the front and rear sprockets. Differently configured gear-tooth combinations are used for different riding conditions. For example, racers who ride mostly on level ground have a narrower gear-ratio range than bike tourists who have to manage both long, level stretches and steep hills. It would be nice to be able to tell what difference it would make riding up that long hill if you changed to a given front and rear sprocket combination.

The program given in listing 1 addresses both of these problems. It will analyze any combination of between five and eighteen speeds; it will produce a shift chart to indicate the order in which to use different combinations of front and rear gear sprockets and a chart of gear range so that comparisons can be made between different combinations of sprockets with variations in the number of gear teeth.

The unit of measure used here for gear range is the traditional one of wheel size. This is the size of the front wheel that would be necessary to produce the same drive

ratio on one of the old high-wheel (ie: penny-farthing) bikes of the nineteenth century. The program is written in TDL 12 K BASIC, but should run unaltered on any computer that uses Microsoft or a similar BASIC system such as the TRS-80, PET, Apple II, or Ohio Scientific. Happy cycling, and wear a helmet!

Listing 1: A program written in TDL 12 K BASIC that calculates the gear ratios available from combinations of front and rear gear sprockets with varying numbers of teeth.

Special language features are as follows. A PRINT USING statement provides formatted output. A simple PRINT will work, but will be slightly less neat. If your BASIC does not have the EXCHANGE statement used in lines 310 thru 314, you can substitute a simple swap routine such as:

$T1 = P(J+1, 1) : P(J+1, 1) = P(J, 1) : P(J, 1) = T1$
to perform the exchange. A question mark is an abbreviation for PRINT.

```
10 'PROGRAM TO CALCULATE 10 SPEED OR 15 SPEED
    GEAR RATIOS
20 DIM W(16),P(16,3)
30 INPUT "NUMBER OF FRONT GEARS";F1
40 INPUT "NUMBER OF GEARS ON REAR
    FREEWHEEL";R1
50 IF F1=0 THEN F1=2
60 IF R1=0 THEN R1=5
70 N=R1*F1
80 INPUT "REAR WHEEL DIAMETER";W1
90 IF F1=3 THEN 120
100 F$(1)="INNER ":F$(2)="OUTER "
110 GO TO 130
120 F$(1)="INNER ":F$(2)="MIDDLE ":F$(3)="OUTER "
130 FOR I=1 TO F1
140 PRINT "NUMBER OF TEETH ON ";F$(I); "GEAR";
150 INPUT T(I)
160 NEXT I
170 FOR I=1 TO R1
180 PRINT "NUMBER OF TEETH ON "; I; " REAR GEAR";
190 INPUT S(I)
200 NEXT I
210 FOR I=1 TO F1
220 FOR J=1 TO R1
225 X=(I-1)*R1+J
230 W(X)=T(I)/S(J)*W1
235 P(X,1)=X:P(X,2)=I:P(X,3)=J
240 NEXT J
250 NEXT I
260 FOR I=1 TO N:P(I,1)=I:NEXT I
270 'START SORT
280 FOR I=1 TO N
290 FOR J=1 TO N-1
300 IF W(P(J,1))<W(P(J+1,1)) THEN 320
310 EXCHANGE P(J,1),P(J+1,1)
312 EXCHANGE P(J,2),P(J+1,2)
314 EXCHANGE P(J,3),P(J+1,3)
320 NEXT J
330 NEXT I
340 ??:?
350 ?"WHEEL";TAB(10);"FRONT";TAB(20);"REAR"
360 FOR I=1 TO N
370 PRINT USING "###.##"; W(P(I,1));
375 PRINT TAB(10);F$(P(I,2));TAB(20);P(I,3)
380 NEXT
390 END
```

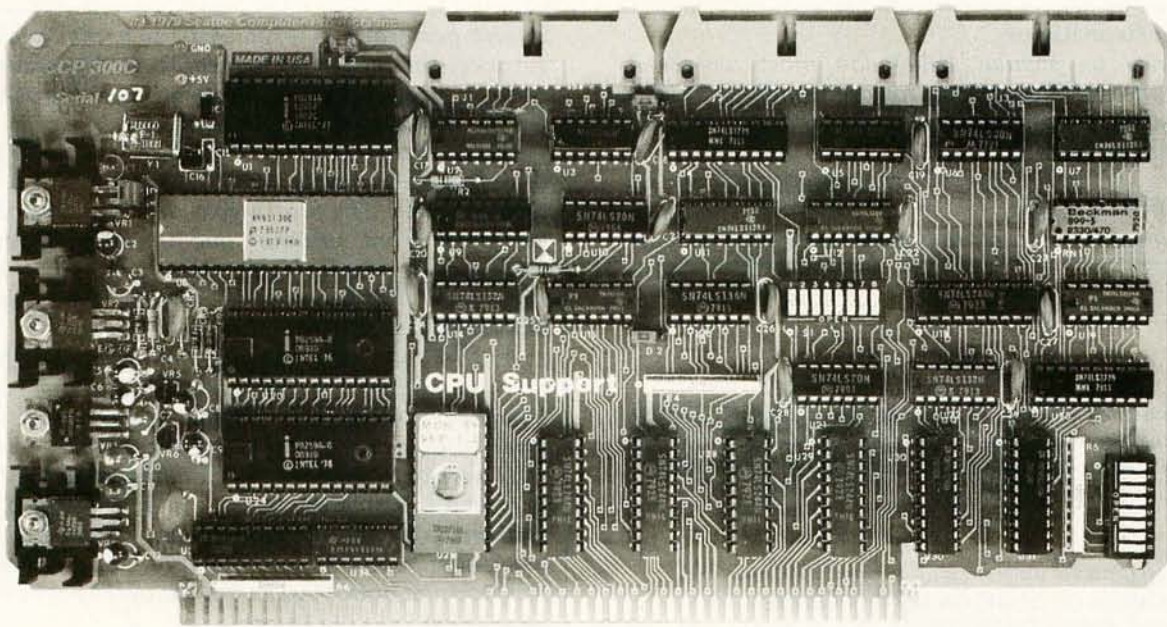
REQUIRED

**For 8080, Z80 and 8086
Multi-User Systems**

If you plan to use multi-user software, you need our CPU Support Card's vectored interrupt controller and sophisticated timers. Whether your system is powered by an 8080, Z80 or 8086, this card was designed to make

software interfacing easy. The card's I/O ports, EPROM socket, and "sense switch" give you an expanded flexibility that can greatly simplify those difficult jobs.

VECTORED INTERRUPT CONTROLLER

The card's vectored interrupt controller uses two 8259As to accept 7 interrupts from the board and 8 from the bus. On-board interrupts are generated by the timer chip (3), the serial port (2), the parallel input port (1), and the parallel output port (1). The 8259As are fully programmable for 8080/Z80 "CALL" mode or 8086 mode.

THE ULTIMATE TIMER CHIP

The card uses Advanced Micro Devices' new Am9513 System Timing Controller — "The Time Machine". Of its five 16-bit counters, one is dedicated to baud rate generation for the serial port while two others can be combined to make a time-of-day clock. All counters are programmable. A special regulator is used for this chip so either +8V or regulated +5V can be provided from an outside source to keep the time-of-day counters running when computer power is off.

OTHER FEATURES

In addition to full modem control and programmable baud rate for the serial port, the card also includes a 8-bit parallel input port, an 8-bit parallel output port, a socket for a 2K EPROM (addressable to F000H, FF000H, F800H, or FF800H — our Monitor fits here if the card is used with our 8086), and an 8-bit "sense switch" input port to use for system control. Power requirements for the card are less than 1.0 amps at +8V (including timer chip) and less than 0.1 amps for each of the +16V and -16V supplies. The card is provided with a 24" cable for the serial port (DB-25 female). Additional cables for the parallel input (female) and output port (male) are available at \$11.50 each.

PRICES

1-4	5-9	10-up
\$370	302	235

(Add \$25 for 8086 Monitor ROM)

HOW TO ORDER

There are two ways to go. You can check with your local dealer or order direct from the factory. Bank cards, personal checks, CODs okay. There is a ten-day return privilege on factory orders. All cards are guaranteed one year — both parts and labor. Shipped prepaid by air from stock.

**Write or check reader service
card for information about our
other 8086 products**

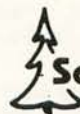

Seattle Computer Products, Inc.

1114 Industry Drive, Seattle, WA. 98188
(206) 575-1830

Notes on Gear Ratios

Contrary to popular belief, on most ten-speed bicycles the first five gear ratios are not all produced using the small front sprocket, with the top five gear ratios correspondingly produced using the large front sprocket. The actual case is more complicated, as can be seen from listing 2.

On many bikes, the setup is as follows. The first and

lowest gear ratio is produced using the small front sprocket and the largest rear sprocket. The second gear ratio is produced using the small front sprocket and the next-to-largest rear sprocket.

Now for the anomaly. The third gear ratio is produced using the large front sprocket and the largest rear sprocket. The fourth gear ratio is obtained using the small front sprocket and the third-largest rear sprocket. For the fifth gear ratio, we move the chain back onto the large front sprocket and onto the second-largest rear sprocket.

At this point, we may become perplexed. Is there not one pattern in the sprocket use that we can remember? Well, there is some regularity. Using the small front sprocket and all the rear sprockets in order from largest to smallest, we obtain gear numbers 1, 2, 4, 6, and 8. Using the large front sprocket and all the rear sprockets in order from largest to smallest, we obtain gear numbers 3, 5, 7, 9, and 10. So really, only the very top and bottom gears fall out of the easily remembered even/odd sequence.

Now you may object, "How am I supposed to follow such a complex shifting sequence while I am dodging traffic, pot holes, and vicious dogs?" Well, you don't have to follow the sequence strictly.

Most bike riders, in fact, rarely use gears three and eight. These are the extreme combinations of large front sprocket with largest rear sprocket, and of small front sprocket with smallest rear sprocket. Since the chain has to bend rather sharply when it is set up in these combinations, mechanical stress and wear are increased.

In my own riding around hilly Peterborough, New Hampshire, I typically leave the chain on the large front sprocket and shift up and down through the range made available by moving the chain to the various rear sprockets. I move the chain to the small front sprocket when I need the bottom two gears, such as when I ride up the steep hill that leads to my home. . . . **RSS** ■

Listing 2: Sample execution of the program of listing 1. The gear ratios are measured in terms of the equivalent size of the front wheel of a high-wheel (ie: penny-farthing) bicycle needed to produce the same final drive ratio.

```

RUN
NUMBER OF FRONT GEARS? 2
NUMBER OF GEARS ON REAR FREEWHEEL? 5
REAR WHEEL DIAMETER? 27
NUMBER OF TEETH ON INNER GEAR? 44
NUMBER OF TEETH ON OUTER GEAR? 52
NUMBER OF TEETH ON 1 REAR GEAR? 14
NUMBER OF TEETH ON 2 REAR GEAR? 16
NUMBER OF TEETH ON 3 REAR GEAR? 18
NUMBER OF TEETH ON 4 REAR GEAR? 20
NUMBER OF TEETH ON 5 REAR GEAR? 22
    
```

WHEEL	FRONT	REAR
54.00	INNER	5
59.40	INNER	4
63.82	OUTER	5
66.00	INNER	3
70.20	OUTER	4
74.25	INNER	2
78.00	OUTER	3
84.86	INNER	1
87.75	OUTER	2
100.29	OUTER	1

READY:

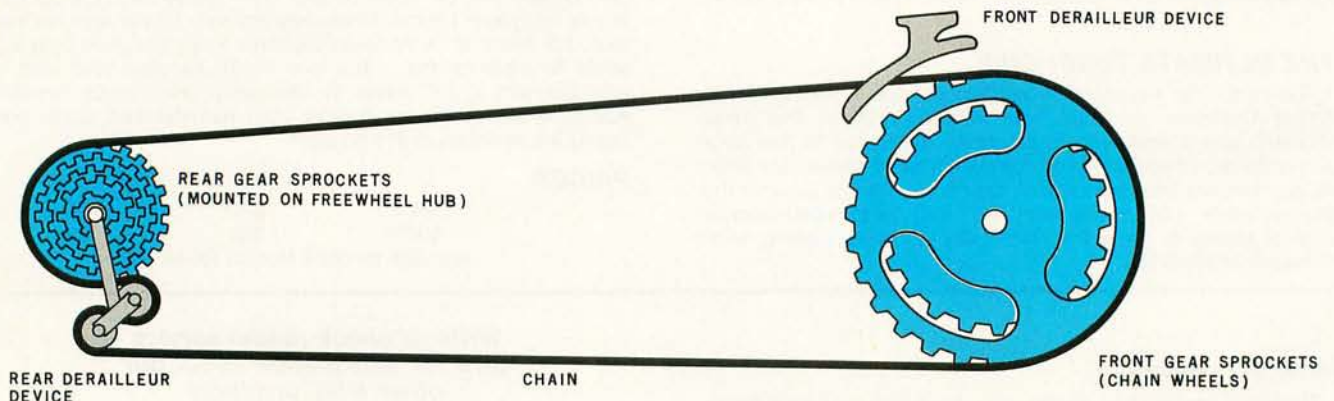
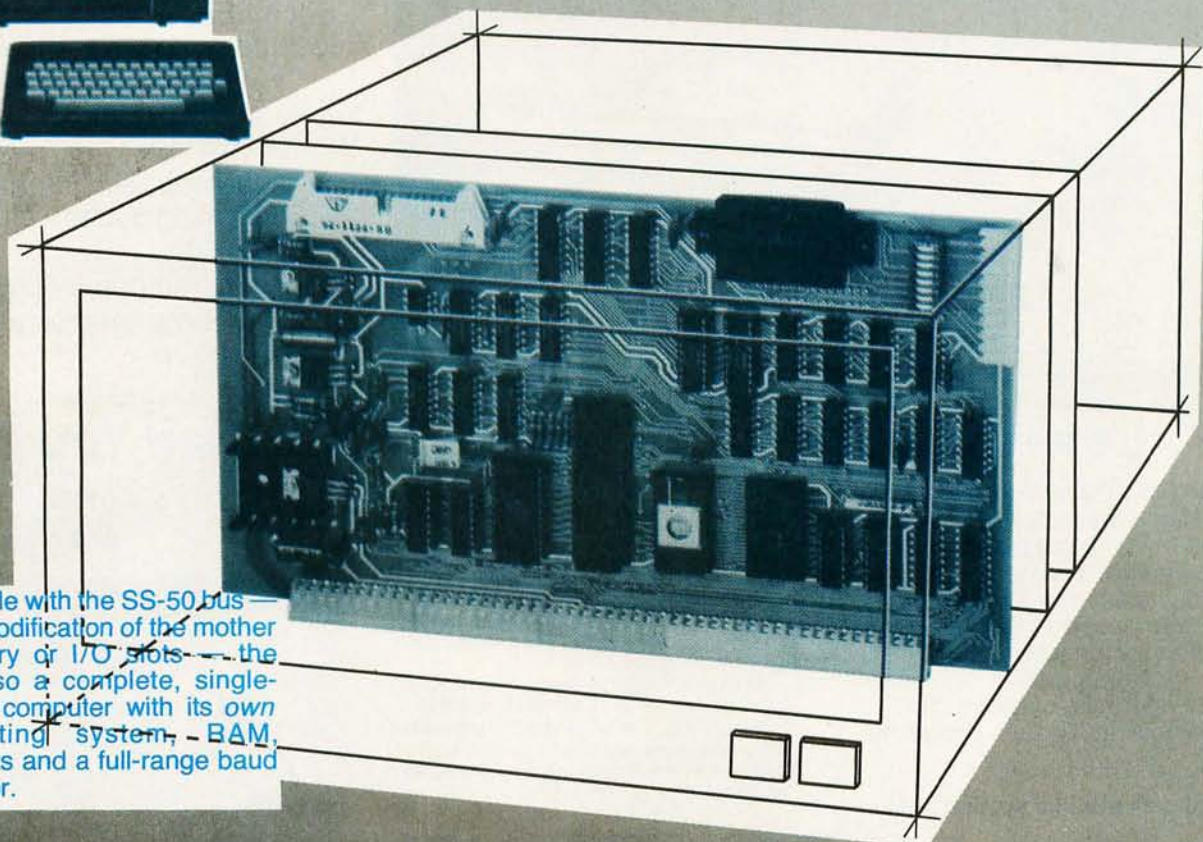

Figure 1: Diagram of the drive mechanism of a ten-speed, derailleur-equipped bicycle. The pedal cranks (not shown) are attached to the front gear sprockets (ie: chain wheels) through the crank axle. The front derailleur device can shift the chain between the large front sprocket and the small front sprocket.

The rear gear sprockets are attached to the rear axle by means of a freewheel hub that allows the rider to stop pedaling while the bicycle remains in motion. The rear derailleur device can shift the chain between any of the five rear gear sprockets. Different front and rear sprocket combinations produce the ten gear ratios.

6809 PROCESSING POWER!

The Percom SBC/9™. Only \$199.95.



Fully compatible with the SS-50 bus — requiring no modification of the mother board, memory or I/O slots — the SBC/9™ is also a complete, single-board control computer with its own ROM operating system, RAM, peripheral ports and a full-range baud clock generator.

Make the SBC/9™ the heart of your computer and put to work the most outstanding microprocessor available, the 6809.

the Mighty 6809

Featuring more addressing modes than any other eight-bit processor, position-independent coding, special 16-bit instructions, efficient argument-passing calls, autoincrement/autodecrement and more, it's no wonder the 6809 has been called the "programmers dream machine."

Moreover, with the 6809 you get a microprocessor whose programs typically use only one-half to two-thirds as much RAM space as required for 6800 systems, and run faster besides.

And to complement the extraordinary 6809, the Percom design team has developed PSYMON™, an extraordinary 6809 operating system for the SBC/9™.

PSYMON™ — Percom System MONitor

Although PSYMON™ includes a full complement of operating system commands and 15 externally callable "trademark of Percom Data Company, Inc.

utilities, what really sets PSYMON™ apart is its easy hardware adaptability and command extensibility.

For hardware interfacing, you merely use simple, specific device driver routines that reference a table of parameters called a Device Control Block (DCB). Using this technique, interfacing routines are independent of the operating system.

The basic PSYMON™ command repertoire may be readily enhanced or modified. When PSYMON™ first receives system control, it initializes its RAM area, configures its console and then 'looks ahead' for an optional second ROM which you install in a socket provided on the SBC/9™ card. This ROM contains your own routines that may alter PSYMON™ pointers and either subtly or radically modify the PSYMON™ command set. If a second ROM is not installed, control returns immediately to PSYMON™.

- Provision for multi-address, 8-bit bidirectional parallel I/O data lines for interfacing to devices such as an encoded keyboard.
- A serial interface Reader Control output for a cassette, tape punch/reader or similar device.
- An intelligent data bus: multi-level data bus decoding that allows multiprocessing and bus multiplexing of other bus masters.
- Extended address line capability — accommodating up to 16 megabytes of memory — that does not disable the on-board baud rate clock or require additional hardware in I/O slots.
- On-board devices which are fully decoded so that off-card devices may use adjoining memory space.
- Fully buffered address, control and data lines.

The SBC/9™, complete with PSYMON™ in ROM, 1K of RAM and a comprehensive users manual™ costs just \$199.95.

PERCOM

PERCOM DATA COMPANY, INC.
211 N. KIRBY GARLAND, TEXAS 75042
(214) 272-3421

Percom 'peripherals for personal computing'

To place an order or request additional literature call toll-free 1-800-527-1592. For technical information call (214) 272-3421. Orders may be paid by check, money order, COD or charged to a VISA or Master Charge account. Texas residents must add 5% sales tax.

Circle 25 on inquiry card.

PRICES AND SPECIFICATIONS SUBJECT TO CHANGE WITHOUT NOTICE

Circle 33 on inquiry card.

Welcome to Percom's Wide World

SS-50 Bus LFD-400™ and LFD-800™ Systems



Each LFD mini-disk storage system includes:

- drives with integral power supplies in an enamel-finished enclosure
- a controller/interface with ROM operating system plus extra ROM capacity
- an interconnecting cable
- a comprehensive 80-page users manual

Circle 34 on inquiry card.

Low-Cost Mini-Disk Storage in the Size You Want.

Percom LFD mini-disk drive systems are supplied complete and ready to plug in the moment they arrive. You don't even have to buy extra memory. Moreover, software support ranges from assembly language program development aids to high-speed disk operating systems and business application programs.

The LFD-400™ and -400EX™ systems and the LFD-800™ and -800EX™ systems are available in 1-, 2- and 3-drive configurations. The -400, -400EX drives store 102K bytes of formatted data on 40-track disks, and data may be stored on either surface of a disk. The -800, -800EX drives store 200K bytes of formatted data on 77-track disks.

The LFD-1000™ systems (not pictured) have dual-drive units which store 800K bytes on-line. The LFD-1000™ controller accommodates two drive systems so that a user may have as much as 1.6M bytes on-line.

Mini-disk storage system prices:

MODEL	1-DRIVE SYSTEM	2-DRIVE SYSTEM	3-DRIVE SYSTEM
For the SS-50 Bus:			
LFD-400™	\$ 599.95	\$ 999.95	\$1399.95
LFD-800™	895.95	1549.95	2195.95
For the EXORciser® Bus:			
LFD-400EX™	\$ 649.95	\$1049.95	\$1449.95
LFD-800EX™	945.95	1599.95	2245.95
LFD-1000™	(dual) \$2495.00	(quad) \$4950.00	—

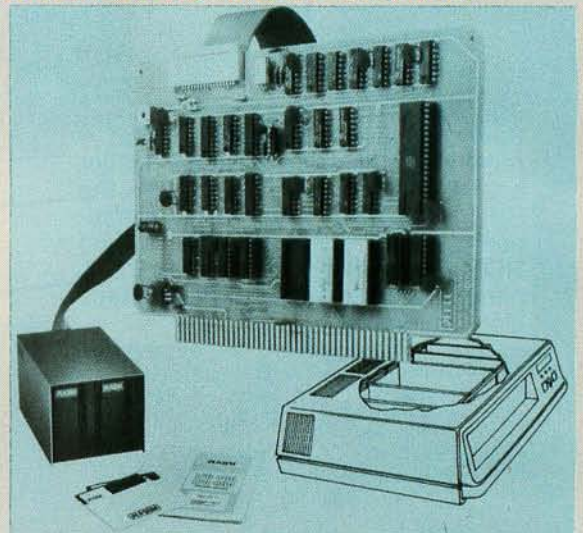

EXORciser® Bus LFD-400EX™, -800EX™ Systems

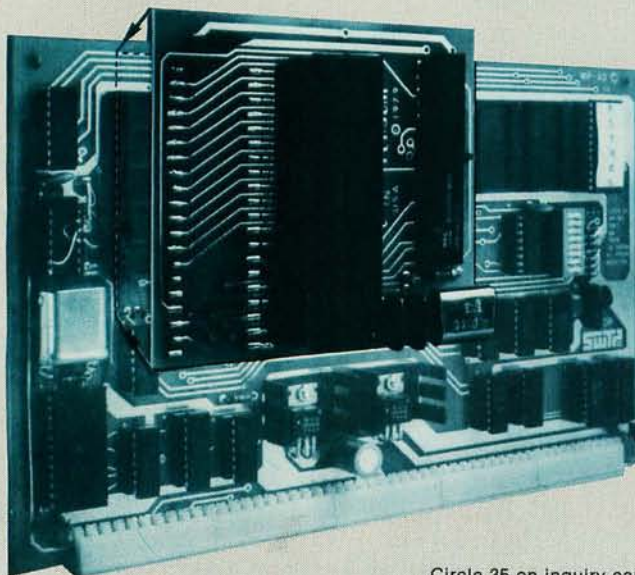

Circle 35 on inquiry card.

Upgrade to 6809 Computing Power. Only \$69.95

Although designed with the SWTP 6800 owner in mind, this upgrade adapter may also be used with most other 6800 and 6802 MPUs. The adapter is supplied assembled and tested, and includes the 6809 IC, a crystal, other essential components and user instructions. Restore your original system by merely unplugging the adapter and a wire-jumpered

DIP header, and re-inserting the original components. Also available for your upgraded system is PSYMON™ (Percom SYstem MONitor), the operating system for the Percom 6809 single-board computer. PSYMON™ on 2716 ROM costs only \$69.95. On diskette (source and object files), only \$29.95.

Data Terminal & Two-Cassette Interface — the CIS-30+



Circle 36 on inquiry card.

- Interface to data terminal and two cassette recorders with a unit only 1/10 the size of SWTP's AC-30.
- Select 30, 60 or 120 bytes per second cassette interfacing; 300, 600 or 1200 baud data terminal interfacing.
- Optional mod kits make CIS-30+ work with any microcomputer. (For MITS 680b, ask for Tech Memo TM-CIS-30+-09.)
- KC Standard/Bi-Phase-M (double frequency) cassette data encoding. Dependable self-clocking operation.
- Ordinary functions may be accomplished with 6800 Mikbug® monitor

Prices: Kit, \$79.95; Assembled, \$99.95. Prices include a comprehensive instruction manual. Also available: Test Cassette, Remote Control Kit (for program control of recorders), IC Socket Kit, MITS 680b mod documentation and Universal Adapter Kit (converts CIS-30+ for use with any computer).

of 6800 Microcomputing.

Circle 38 on inquiry card.

6800/6809 SOFTWARE

System Software

6800 Symbolic Assembler — Specify assembly options at time of assembly with this symbolic assembler. Source listing on diskette \$29.95
Super BASIC — a 12K extended random access disk BASIC for the 6800 and 6809. Supports 44 commands and 31 functions. Interprets programs written in both SWTP 8K BASIC (versions 2.0, 2.2 & 2.3) and Super BASIC. Features: 9-digit BCD arithmetic, Print Using and Linput commands, and much more. Price \$49.95
TOUCHUP™ — Modifies TSC's Text Editor and Text Processor for Percom mini-disk drive operation. Supplied on diskette complete with source listing \$17.95

Operating Systems

INDEX™ — This easy-to-use disk-operating and file management system for 6800 microcomputers is fast. I/O devices are serviced by interrupt request. INDEX™ accesses peripherals the same as disk files — new devices may be added without changing the operating system. Other features: unlimited number of DOS commands may be added • over 60 system entry points • display only those files at or above user-specified file activity level • versions available for SWTP MF-68, Smoke's BFD-68 and Motorola's EXORCiser*. Price \$99.95
MINIDOS-PLUSX™ — An extension of the original MINIDOS™ for LFD-400™ mini-disk systems, MINIDOS-PLUSX™ manipulates files by six-character names. Supports up to 31 files. Resident commands include Initialize, Save, Allocate, Load, Files (directory list), Rename and Delete. Supplied on 2708 ROM with a minidiskette that includes transient utilities such as Copy, Backup, Create, Pack and Print Directory. Price \$34.95.
PSYMON™ — Percom SYStem MONitor for the Percom single-board/SS-50-bus-compatible 6809 computer accommodates user's application programs with any mix of peripherals **without** modifying programs. PSYMON™ also features character echoing to devices other than the communicating device, sophisticated register and memory dump routines and more. Price (on 2716 ROM) \$69.95.
WINDEX™ — Described in detail elsewhere on this page.

Business Programs

General Ledger — For 6800/6809 computers using Percom LFD mini-disk storage systems. Requires little or no knowledge of bookkeeping because the operator is prompted with non-technical questions during data entry. General Ledger updates account balances immediately — in real time, and will print financial statements immediately after journal entries. User selects and assigns own account numbers; tailors financial statements to firm's particular needs. Provides audit trail. Runs under Percom Super BASIC. Requires 24K bytes of RAM. Supplied on minidiskette with a comprehensive users manual. Price \$199.95.
FINDER™ — This general purpose data base manager is written in Percom Super BASIC. Works with 6800/6809 computers using Percom LFD-400™ mini-disk drive storage systems. FINDER™ allows user to define and access records using his own terminology — customize file structures to specific needs. Basic commands are New, Change, Delete, Find and Pack. Add up to three user-defined commands. FINDER plus Super BASIC require 24K bytes of RAM. Supplied on minidiskette with a users manual. Price \$99.95
Mailing List Processor — Powerful search, sort, create and update capability plus ability to store 700 addresses per minidiskette make this list processor efficient and easy to use. Runs under Percom Super BASIC. Requires 24K bytes of RAM. Supplied on minidiskette with a users manual. Price \$99.95.

From the Software Works
 Development and debugging programs for 6800 μCs on diskette:
 Disassembler/Source Generator \$30.95
 Reloc'ng Disas'mblr/Segmented Text Gen \$40.95
 Disassembler/Trace \$25.95
 Support Relocator Program \$25.95
 Relocating Assembler/Linking Loader \$55.95
 SmithBUG** (2716 EPROM) \$70.00

Circle 37 on inquiry card.

1/2-Price Special on Hemenway Software!

CP/68‡ disk operating system \$49.97
 STRUBAL+‡ compiler \$124.97
 EDIT68 text editor \$19.97
 MACRO-Relocating Assembler \$39.97
 Linkage Editor (LNKEDT68) \$24.97
 Cross Reference utility \$14.97

®trademark of Percom Data Company, Inc.

* trademark of Motorola Corporation

‡Trademark of Hemenway Associates Company

**SmithBUG is a trademark of the Software Works Company

This programmable VIDEO DISPLAY CONTROLLER

processes display changes instantly in real-time. The Electric Window™ resides completely in main memory so control is accomplished by direct MPU access to the character-store memory and display control registers. Peer at the screen and you look right into video display memory space while you input and manipulate text — an indispensable feature for efficient screen editing and word processing. The Electric Window™. It's worth looking into. Features include:

- Programmable CRT controller chip that provides extraordinary versatility in software control of horizontal and vertical formatting, cursor positioning, scrolling and Start/Reset functions.
- A standard ASCII 128-unit ROM character generator which generates easy-to-read 7 x 12 dot-matrix characters with lower case descenders. Plus . . .
- Provision for an optional ROM that may be programmed for special symbols or characters.
- Resides entirely in 2K on-board RAM mapped into main memory.

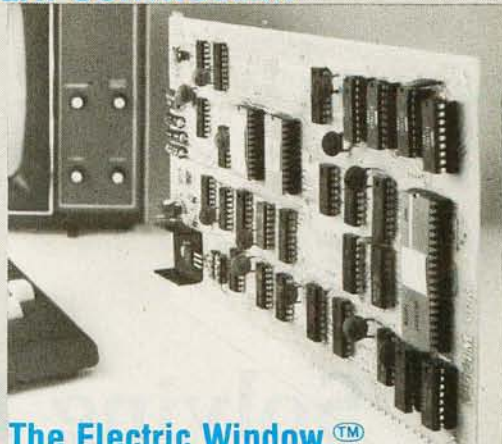

The Electric Window.™ Worth Looking Into. \$249.95

- An optional software driver program called WINDEX™ that complements the fast, hardware-implemented functional capability of the controller. WINDEX™ will auto-link to PSYMON™, the monitor for the Percom SBC/9™ single board computer. The ROM version of WINDEX™ costs \$39.95. The minidiskette version (with source and object files) sells for \$29.95.
- Up to 24 80-character lines — programmable.
- Program control of display highlighting.
- Program interlaced or non-interlaced scan.
- Use either standard video monitor or modified tv.

Now Available! the SBC/9™ MPU/Control Computer

(Single-Board-Computer/6809) — stands alone as a control computer, but also compatible with the SS-50 bus for use as an MPU card. Includes PSYMON™ (Percom SYStem MONitor) in a 1K ROM and provides for additional 1K of ROM. Also includes 1K of RAM. Features: Super Port — provision for multi-address, 8-bit bidirectional data lines • an intelligent data bus for multi-level data bus decoding • an on-board 110-baud to 19.2 kbaud clock generator • extended address capability — to 16 megabytes — without disabling baud clock or adding hardware. And much more. Supplied with PSYMON™ and comprehensive users manual. Price \$199.95.
 See full page ad elsewhere in this magazine for all of the SBC/9™ features.

Full Feature Prototyping PC Boards

All of the features needed for rapid, straightforward circuit prototyping. Use 14-, 16-, 24- and 40-pin DIP sockets • SS-50 bus card accommodates 34- and 50-pin ribbon connectors on top edge, 10-pin Molex connector on side edge • I/O card accommodates 34-pin ribbon connector and 12-pin Molex on top edge

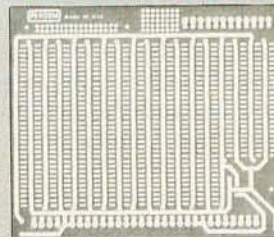

I/O Bus Card: \$14.95

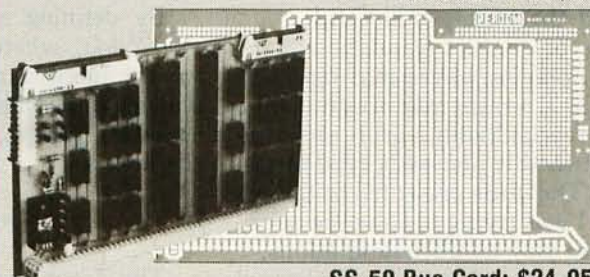
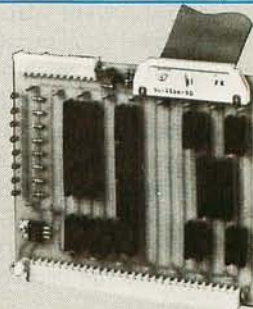

SS-50 Bus Card: \$24.95

- I/O card is 1-1/4 inches higher than SWTP I/O card • interdigitated power conductors • contacts for power regulators and distributed capacitance bypassing
- use wire wrap, wiring pencil or solder wiring • tin-lead plating over 2-oz copper conductors wets quickly, solders easily
- FR4-G10 epoxy-glass substrate.

Circle 40 on inquiry card.

To place an order or request additional literature call toll-free 1-800-527-1592. For technical information call (214) 272-3421. Orders may be paid by check, money order, COD or charged to a VISA or Master Charge account. Texas residents must add 5% sales tax.

PRICES AND SPECIFICATIONS SUBJECT TO CHANGE WITHOUT NOTICE.

PERCOM

PERCOM DATA COMPANY, INC.
 271 N. KIRBY GARLAND, TEXAS 75042
 (214) 272-3421

Solving Problems Involving Variable Terrain

Part 2: Special Cases, Including Hexagonal Grids

Scott T Jones
271 NW 28th St
Boca Raton FL 33431

In part 1 some general terrain problems were defined. These were problems that could be expressed in terms of movement on a map, with terrain defined as any map feature affecting movement. By superimposing a rectangular grid and coordinate system on these maps, we were then able to represent the terrain with a set of boolean arrays or terrain masks. Movement, distance, and the concept of movement cost for different types of terrain were also defined. A scatter function was then defined to generate scatter maps representing all possible movement within the limits imposed by the terrain.

Finally, we demonstrated the use of these scatter maps to solve such problems as the feasibility of road construction within cost restraints and the determination of an optimal path between two points on a map, across variable terrain.

Part 2 is concerned with the application of these techniques to the problems encountered in conflict simulations.

Conflict Simulations and the Hexagonal Grid

The most common type of conflict simulation is the war game. In a war game, playing pieces that represent military units are moved on a terrain map to simulate a battle. The map has been overlaid with a grid; each unit has an inherent movement factor; and each type of terrain has a movement cost. The ideas presented in this article were developed when I was trying to solve the problems of writing programs to play conflict simulations.

The most common grid used today is the hexagonal grid. Instead of an array of squares, the map is divided into hexagons or "hexes" to form a honeycomb pattern. Each hexagon has six adjacent hexagons. We can easily define the distance between a hexagon and any adjacent hexagon to be equal to 1 without worrying about the am-

biguous, diagonally adjacent squares that we encountered with rectangular grids. The problem is in defining a coordinate system and a distance function or metric.

Most games use an *offset* coordinate system. The hexagonal grid is treated as a rectangular grid in which every even-numbered column is offset by one-half the size of the squares. (See figure 9.) The trouble with this system is that there is no uniform relationship between these coordinates and a metric. Note the relationships of the coordinates of those hexagons adjacent to (2,2) as opposed to (3,2). Separate metrics must be used for the even and odd values of the first coordinate. Clearly, another system is required.

The solution is the *slant* coordinate system (X,Y) where the second coordinate is constant along a slanting, diagonal line from upper right to lower left, or vice-versa. (See figure 10.) The relationships of the coordinates are now consistent throughout the array.

By defining a third, dependent coordinate Z to be $X - Y + C$, where C is any integer constant, our slant metric (ie: distance function) is simply the maximum of the absolute values of the differences of the three coordinates. That is, for (a,b,c) and (d,e,f), the distance is defined as:

$$\max(|a-d|, |b-e|, |c-f|)$$

The Z coordinate is constant along the other slanting line from upper left to lower right. It will be left for the reader to prove both of these statements by working examples with figure 10.

Using these slant coordinates, we can now assign any hexagon to a square in a standard, rectangular scatter

YOU WIN!



with SYBEX

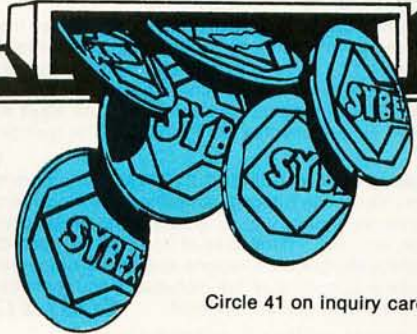

Circle 41 on inquiry card.

PROGRAMMING THE 6502

This book is designed as a progressive, step-by-step approach to assembly language programming—with exercises developed to test the reader at every step. Learn to write complete applications programs. Features: Programming and addressing techniques, input/output techniques and devices, application examples, data structures, program development and more.

Ref. C202 \$12.95

6502 APPLICATIONS BOOK

This title presents real life application techniques for any 6502 based micro-computer board. Programs presented cover building a complete home alarm system, electronic piano, motor speed regulator... and more. Learn techniques ranging from simulated traffic control to analog-digital conversion. The KIM-1, SYM-1 and AIM 65 are thoroughly covered.

Ref. D 302 \$12.95

6502 GAMES

Designed as an educational text on advanced programming techniques, this book presents a comprehensive set of algorithms and programming techniques for common computer games. All of the programs were developed for the 6502 at the assembly language level. Learn how to devise strategies suitable for the solution of complex problems commonly found in games.

Ref. G402 \$12.95

Please send me _____ Charge my _____ Visa _____ Mastercharge _____
 Name _____ American Express _____
 Company _____ Card# _____ Exp. Date _____
 Address _____ Signature _____
 City _____ State _____ Zip _____ Please send me your detailed catalog.

TO ORDER:
By Phone: (415) 848-8233, Visa, MC, AmEx
By Mail: Indicate quantity desired. Pre-payment required
Shipping: Add \$1.50 per book (UPS) or 75¢ (4th Class - allow 4 weeks delivery)
Tax: In California please add tax
AVAILABLE AT BOOK AND COMPUTER STORES EVERYWHERE

SYBEX Dept. B3
 2344 Sixth St.
 Berkeley, CA
 94710

GREAT PET SOFTWARE!



"Precise, humanized, well documented an excellent value" are the applauds now being given to United Software's line of software. These are sophisticated programs designed to meet the most stringent needs of individuals and business professionals. Every package is fully documented and includes easy to understand operator instructions.

KRAM - Keyed Random Access Method - The new, ultra-fast access method for the PET Disk, provides keyed retrieval/storage of data, in either direct or sequential mode, by either full or partial key values. Written by United Software in 6502 machine code, and designed with the PET in mind, it exploits all the benefits of the PET Disk, allowing full optimization of your system. Eliminates the need for "Sort" routines! KRAM provides flexibility never seen on a micro before. KRAM is modeled after a very powerful access method used on large-scale IBM Virtual Storage mainframes. So "KRAM" all you can into your PET - it will love you for it. . . . **COST \$79.95**

ACCOUNTS RECEIVABLE/PAYABLE - A complete, yet simple to use accounting system designed with the small businessman in mind. The United Software system generates and tracks purchase orders and invoices all the way through posting "controlled" accounts payable and accounts receivable subsystems. Keyed Random Access file methods makes data access almost instantaneous. The low-cost solution for the first time computer user with up to 500 active accounts. Requirements - 32K PET, Dual Disk, any 80-column printer. . . . **COST \$175**

CASH RECEIPTS & DISBURSEMENTS - Makes it a breeze to track all outgoing payments made by any type of business operation. Checks are tracked by number and categorized by type of expense. Sorting, summary, and audit trails make it easy to post to general ledger. This system also categorizes incoming receipts. Uses KRAM file access method. Requirements - 32K PET, Dual Disk (printer optional). . . .

COST \$99.95

DATABASE MANAGEMENT SYSTEM - A comprehensive, interactive system like those run on mainframes! Six modules comprising 42K of programming allow you to; create, edit, delete, display, print, sort, merge, etc., etc. - databases of up to 10,000 records. Printer routines automatically generate reports and labels on demand. 60 pages of concise documentation are included. Requirements - 16-32K PET and 2040 Dual Disk (printer optional). . . . **COST \$125**

(Sublicenses available to software houses.)

PROGRAMS FOR ENTERTAINMENT

Space Intruders
("Best Game of 1979") . . . \$19.95
Jury/Hostage 12.50
Kentucky Derby/Roulette . . . 9.95
Alien I.Q./Tank 9.95
Tunnelvision/Maze Chase . . . 14.95
Submarine Attack 9.95
Battle of Midway 7.95
Laser Tank Battle 9.95
Swarm 14.95

Super Startrek 14.95
PET Music Box 29.95

UNITED SOFTWARE PROGRAMS FOR BUSINESS

Checkbook \$15.95
Mortgage 15.95
Finance 12.95
Bonds 12.95
Stock Analyzer 22.95
Stock Options 24.95
6502 Macro Assembler 49.95

Look for the RED-WHITE-BLUE United Software Display at your local computer dealer, or send check or moneyorder, plus \$1.00 shipping to:

UNITED SOFTWARE OF AMERICA
750 Third Ave. **DEALER ORDERS INVITED**
New York, N.Y. 10017 **(212) 682-0347**

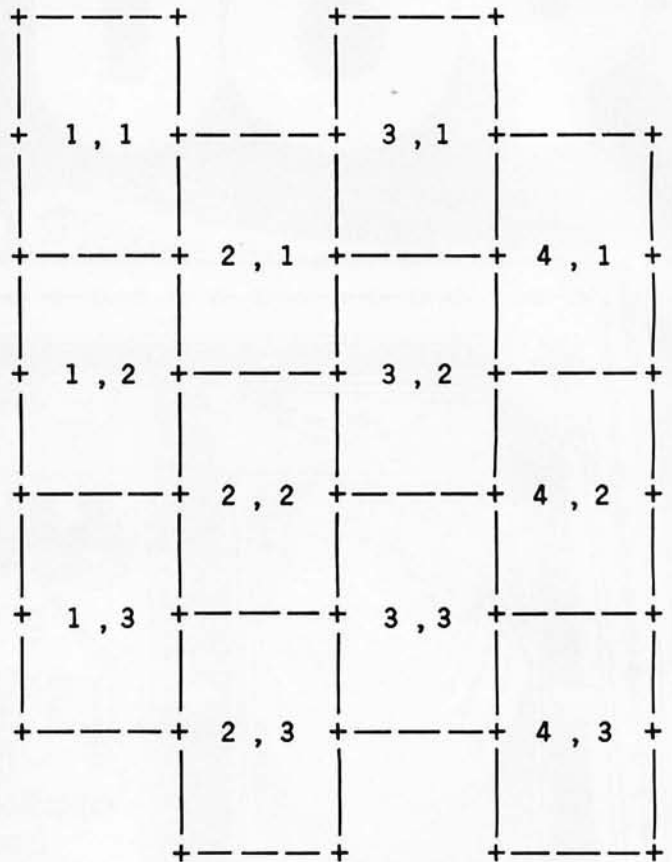

Figure 9: When working with a hexagonal grid, a set of coordinates different from those used for a square grid must be developed. One such coordinate system, shown here, is the offset coordinate system. This system produces difficulties when the distance between two coordinates must be determined. (Numbering of figures is continued from Part 1.)

mapping. Each hexagon (X,Y) is assigned to the square or element in row X and column Y of the two-dimensional matrix. The hexagonal scatter function HSC will assign to each element in array B the value:

$$B(I,J) = \text{HSC}(A(I,J)) = A(I,J) \text{ OR } A(I-1,J-1) \text{ OR } A(I-1,J) \\ \text{OR } A(I,J-1) \text{ OR } A(I,J+1) \\ \text{OR } A(I+1,J) \text{ OR } A(I+1,J+1)$$

Figure 11 demonstrates the scatter mappings that are generated from the same initial position used with the square and city scatter functions in a previous example. (See part 1, figure 4.)

If we are working with a map that already has offset coordinates printed on it, in a case where we would prefer to use slant coordinates, the following relations allow an easy transformation from one system to the other:

$$X(\text{slant}) = X(\text{offset})$$

and

$$Y(\text{slant}) = Y(\text{offset}) + \text{INT}(X/2)$$

where INT is the greatest-integer function.

THE MOST POWERFUL MICROCOMPUTER SOFTWARE EVER DEVELOPED IS ALSO THE EASIEST TO USE

MIMP MICROSYSTEMS INFORMATION MANAGEMENT PACKAGE

AND

BUS-II

GENERAL ACCOUNTING PROGRAM

FOR USE ON

OHIO SCIENTIFIC

MICROCOMPUTERS

MICROSYSTEMS INFORMATION MANAGEMENT PACKAGE

PUTS ANY OR ALL YOUR BUSINESS FILES INTO A POWERFUL DATABASE.

CREATE VIRTUALLY ANY RELATIONSHIP YOU CAN THINK OF. ENGLISH-SPEAKING REPORT GENERATOR.

POWERFUL USER COMMANDS NORMALLY FOUND ONLY IN LARGE COMPUTERS. SELF-EXPLANATORY, EASY TO USE, SUCH AS "INPUT," "OUTPUT," "LIST," "PRINT," "CHANGE," "DELETE," "EXCLUDE," "INCLUDE," AND, PERHAPS MOST IMPORTANT OF ALL, "HELP!"

STRAIGHTFORWARD INPUT AND EDITING ROUTINES— "IDIOT-PROOF."

OPERATOR'S MANUAL WITH FULL USER INSTRUCTIONS IS ON-LINE WITH HELP COMMANDS. PROBLEMS? JUST TYPE "HELP!"

COMMANDS CAN BE USED CONDITIONALLY ON ANY RECORD OR ON ANY FIELD WITHIN A RECORD.

IN-MEMORY SORT, OR, (FOR BIG FILES) DISK SORT.

ALL DATABASE FUNCTIONS ARE SUBROUTINES— CUSTOM PROGRAMMING SIMPLIFIED.

OPTIONAL CASH REGISTER POLLING AND CONTROL PACKAGE AVAILABLE TO QUALIFIED BUYERS (REQUIRES INSTALLATION CONSULTATION).

OVER TWO YEARS' IN-FIELD TESTING. MIMP WORKS— FLAWLESSLY.

ONE YEAR SUBSCRIPTION TO APPLICATIONS NEWSLETTER FREE WITH PURCHASE.

TYPICAL APPLICATIONS: INVENTORY, CUSTOMER FILES, CASH REGISTER CONTROL (OPTIONAL EXTRA), DOCTOR/DENTIST/LAWYER APPOINTMENTS OR CLIENT/PATIENT FILES, SALES RECORDS, MAILING LISTS.

INTRODUCTORY OFFER

\$295

THE KEY TO THIS SOFTWARE IS ITS SIMPLICITY OF OPERATION.

BUS-II

BOOKKEEPING/ACCOUNTING SYSTEM

CPA-APPROVED COMPLETE ACCOUNTING SYSTEM: GENERAL LEDGER, ACCOUNTS PAYABLE, ACCOUNTS RECEIVABLE.

BRANCH ACCOUNTING HANDLES UP TO FIVE DIVISIONS.

COMPLETELY INTERACTIVE. SELF-UPDATING.

BATCH ACCOUNTING INSISTS ON BEING "IN BALANCE."

USER MENU. OPERATOR PROMPTING FOR CORRECT ENTRIES.

HIGHLY FLEXIBLE FORMATTING OF FINANCIAL REPORTS.

NO KNOWLEDGE OF DEBITS AND CREDITS REQUIRED (EXCEPT RECURRING JOURNAL ENTRIES— ASK YOUR ACCOUNTANT).

EXAMPLES OF REPORTS (FROM GENERAL LEDGER MODULE)

GENERAL LEDGER REPORTS

CHART OF ACCOUNTS
CASH DISBURSEMENTS
STATEMENT OF INCOME
JOURNAL ENTRIES

CASH RECEIPTS
BALANCE SHEET
DAILY TRANSACTION LISTING
DETAILED GENERAL LEDGER

ACCOUNTS PAYABLE REPORTS

CHECKS TO BE WRITTEN
ACCOUNTS PAYABLE
VENDOR LISTING

CHECK REGISTER
INVOICES NOW DUE

ACCOUNTS RECEIVABLE REPORTS

CHECKS TO BE WRITTEN
CURRENT ACCOUNTS
RECEIVABLE
PRINT STATEMENT

MONTHLY TRANSACTION LISTING
DETAILED ACCOUNTS RECEIVABLE
LISTING OF PAST DUE ACCOUNTS

IDEAL FOR ACCOUNTING FIRMS AS WELL AS SMALL BUSINESSES.

PROVEN THROUGH YEARS OF USE.

THIS ACCOUNTING PACKAGE REQUIRES ONLY A HIGH SCHOOL-LEVEL UNDERSTANDING OF BOOKKEEPING.

ONLY

\$295

DUAL EIGHT-INCH FLOPPY DISK DRIVES REQUIRED.

MIMP & BUS-II OPERATE ON ALL OHIO SCIENTIFIC 8-INCH OR WINCHESTER DISK MICROCOMPUTERS W/48 K RAM.

USER-ORIENTED SYSTEMS

— NO PROGRAMMING REQUIRED

CREDIT CARD ORDERS

CALL

(304) 291-5400



SEE YOUR OSI DEALER FOR DEMONSTRATION

ALL ORDERS SHIPPED PREPAID WITHIN CONTINENTAL U.S. PLEASE DO NOT SEND CASH. OVERSEAS ORDERS PLEASE INCLUDE POSTAGE— 5 LBS. SORRY, NO C.O.D.

digital technology

ROCKLEY ROAD

inc.

MORGANTOWN, WV 26505

Circle 42 on inquiry card.

Pacenter™

Desoldering Systems



MODEL PC-10: Finger Controlled

REMOVE ANY COMPONENT FROM ANY PCB ... QUICKLY AND SAFELY



MODEL PC-20: Footpedal Controlled

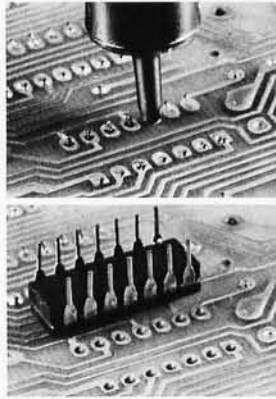

STANDARD SYSTEM FEATURES

- Lightweight and Portable
- Internal Vacuum Pump
- Sodr-X-Tractor Handpiece
- Variable Temperature Control

PAGE
INCORPORATED

9329 Fraser Street ■ Silver Spring, Md. 20910 ■ (301) 587-1696

Double your memory ... not the price!

COMPARE AT \$695 ...

\$525



**Remex RFD 4000/8''
Floppy Disc Drive
Double the storage!
Double sided ...
Double density!!**

Offers quality and features found in drives costing much more! ■ Single or Double Density ■ Double-Sided Drive ■ Door Lock INCLUDED ■ Write-Protect INCLUDED ■ 180 Day Warranty ■ Compatible with Shugart 850/851 ■ Low Power Operation ensures LONGER LIFE!! ■ Model RFD 4001 offers Data and Sector Separator

AVAILABLE OPTIONS/ACCESSORIES

- Dual Drive Power Supply and Cabinet, \$119.95
- Interface Manual, \$2.95
- RFD 4000 Manual, \$5.95
- Drive Cabinet, \$29.95

SIRIUS SYSTEMS, P.O. Box 9748, Knoxville, TN., 37920
Phone orders accepted 9 AM-7 PM (E.S.T.): 615/577-1072, please send the following
 RFD 4000, \$525 RFD 4001, \$539 / Check Money Order C.O.D. MC VISA AE

NAME _____ CARD # _____

ADDRESS _____ EXPIRATION DATE _____

CITY _____ STATE _____ ZIP _____ CARDHOLDERS SIGNATURE _____

Add \$7.00 per Drive for Shipping/Handling Tennessee residents add 6% sales tax. Foreign orders add 10% (payment in U.S. currency only)

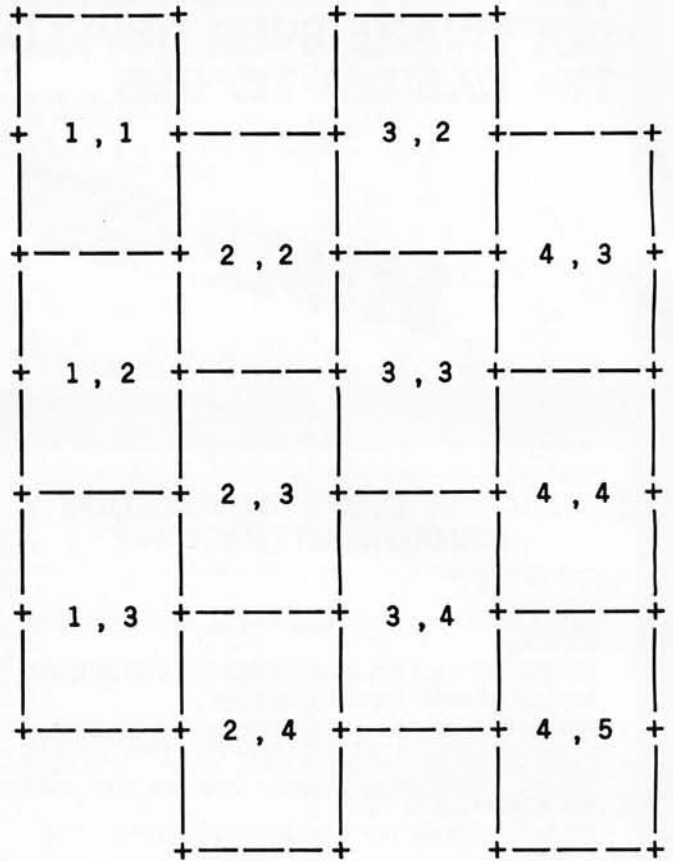

Figure 10: A coordinate system that solves the distance problems found in the offset coordinate system is the slant coordinate system. In this system, one of the coordinates is constant along a diagonal (ie: slanted) axis.

Specific Game Applications

It should now be obvious how to determine movement in a game environment when fixed terrain is the only constraint. However, in many war games, the concept of a zone of control introduces a new type of terrain. The unit may enter this zone at the normal movement cost but may not leave until the opposing unit that imposed the zone of control is removed, usually by combat of some form.

A unit's zone of control is usually defined as all positions (ie: squares or hexagons) that are adjacent to the unit's own position. In other words, a unit's zone of control is simply the first scatter mapping of its position. Thus, when moving with the constraints of zones of control, a new terrain map Z must be defined where Z(I,J) is 0 if (I,J) is 1 in the first scatter mapping of any opposing unit, and Z(I,J) = 1, otherwise.

This terrain map is then used to mask out starting positions that will be used on the next scatter. This gives us the relation:

$$M_n = M_{n-1} \text{ OR } (T_1 \text{ AND } XSC(Z \text{ AND } M_{n-1}))$$

$$\text{OR } (T_2 \text{ AND } XSC(Z \text{ AND } M_{n-2}))$$

·
·
·

$$\text{OR } (T_k \text{ AND } XSC(Z \text{ AND } M_{n-k}))$$

Meet two new Printers from Anadex:

Revolutionary!

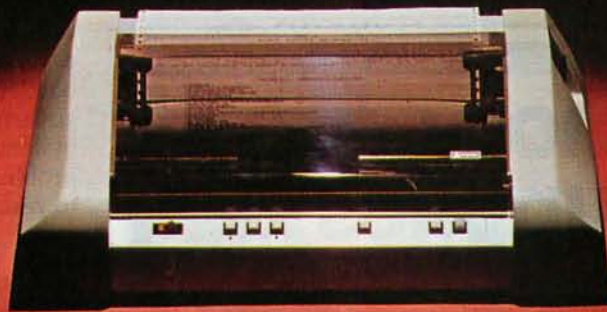

Introducing two totally new alphanumeric line printers from Anadex - Models DP-9500 and DP-9501 - featuring 132/175 or 132/220 columns, respectively.

Both models employ a new, Anadex-manufactured 9-wire print head with 150 million character life (optionally, 650 million) that makes them ideal for high-resolution printing requirements including high-density graphics where print quality and reliability must go hand in hand.

The full standard 96 character ASCII character set, including descenders and underlining of all upper and lower case letters, can be printed bidirectionally on up to 5 crisp copies at speeds up to 200 CPS. Adjustable-width tractors, accommodating paper from 1.75 to 15.6 inches wide, allow the printers to adapt to your application.

The three ASCII compatible interfaces (Parallel, RS-232-C, and Current Loop) are standard in every printer; so interfacing is usually a matter of "plug it in and print." With simplified interfacing, the printers also feature sophisticated communications capability including control of Vertical Spacing (6 or 8 lines/inch), Form Length and Width, Skip-Over Perforation, Auto Line Feed, and full point-to-point communications capability.

Other standard features are a 500 character FIFO buffer (optional, an additional 2048 character buffer), shortest distance sensing logic, self test, and replaceable ribbon cartridge with 6 million character life.

For complete details, attractive OEM pricing, and a demonstration, contact Anadex today.



0 0 0 0 0	0 0 0 0 0	1 1 1 0 0
0 0 0 0 0	0 1 1 0 0	1 1 1 1 0
0 0 1 0 0	0 1 1 1 0	1 1 1 1 1
0 0 0 0 0	0 0 1 1 0	0 1 1 1 1
0 0 0 0 0	0 0 0 0 0	0 0 1 1 1
a. A	b. HSC(A)	c. HSC(HSC(A))

Figure 11: An example of the hexagonal scatter-function mappings that develop from a central starting point, assuming that the movement cost of all terrain is equal.

This relation now shows how we can "premask" our scatter mappings to include the effects of zones of control or other types of no-exit terrain found on our terrain map

while we postmask to include the effects of movement costs.

This relation is the basis for our movement algorithm in most conflict simulations. With it, we can easily determine not only if a unit can reach a position, but also if the unit is inhibited by opposing units or if it is surrounded. By operating with sets of these scatter mappings, we can even coordinate the moves of a group of units. Scatter mappings can be weighted by the relative combat strengths of the corresponding units so that sums of these weighted mappings represent the total strength that can be applied to any position on the map.

The metrics (ie: distance functions) work well as range functions for game features that are unaffected by terrain,

such as determining the range to a target in the simulation of naval battles. Line-of-sight rules that govern the use of projectile weapons in land-battle simulations pose new problems which we will not attempt to resolve at this time.

Directional Terrain Features

In a game environment, concessions are often made to the scale of the terrain map. This means that prohibited terrain, like rivers, or ideal terrain, such as roads, must be represented in a nonstandard way. In situations where you are not fixed by the terrain map provided with the game, you may either increase the scale so that terrain types can be easily isolated, or reduce the scale so that single locations contain many types of terrain, but the effects are dominated by only one type.

With a fixed scale, however, our algorithm must be modified. For example, when we have roads that lower the movement cost for units following the road, we must first adjust our cost scale so that this cheaper, road-movement cost is our unit cost.

Next we must define a set of directional terrain masks which function like the zone-of-control masks to premask invalid starting positions for the direction being considered. In the mask for a given direction, the locations contain values of 1 if movement is allowed from the current position in that given direction. Otherwise, the locations contain 0.

The number of directional terrain masks required equals the number of possible movement direction

Disk Memory Power Supplies

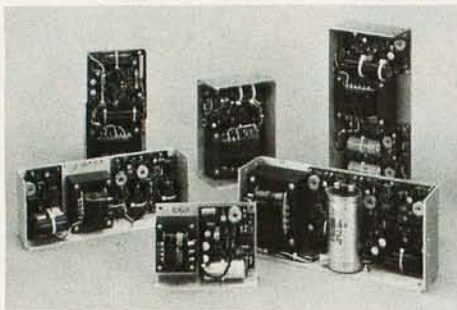

Power-One, a leading supplier to the Disk Drive Industry, now offers a complete line of power supplies for FLOPPY DISK and new WINCHESTER FIXED DISK applications.

Call or Write for our New Catalog.

WINCHESTER FIXED DISK

SHUGART - CENTURY - MICROPOLIS are just a few drives powered by this new universal model. Powers (1) Winchester drive plus controller circuitry.

1st Output	2nd Output	3rd Output	Model	Price (1-9)
+ 5V @ 9A	- 12V @ .8A	+ 24V @ .5A/4.5A PK	CP384	\$120.00

FLOPPY DISK - 5 1/4" MEDIA

BASF - SHUGART - PERTEC - SIEMENS plus all other popular 5 1/4" media drives.

1st Output	2nd Output	Model	Price (1-9)
+ 5V @ .5A/.7A PK	+ 12V @ .9A/1.8A PK	CP340	\$ 44.95
+ 5V @ 2A	+ 12V @ 4A	CP323	\$ 74.95

CP323 powers up to (4) drives simultaneously.

FLOPPY DISK - 8" MEDIA

SHUGART - PERSCI - CDC - WANGCO plus many other single and multiple drive applications.

1st Output	2nd Output	3rd Output	Model	Price (1-9)
+ 5V @ 1A	- 5V @ .5A	+ 24V @ 1.5A/1.7A PK	CP205	\$ 69.95
+ 5V @ 2.5A	- 5V @ .5A	+ 24V @ 3A/3.4A PK	CP206	\$ 91.95
+ 5V @ 3A	- 5V @ .6A	+ 24V @ 5A/6A PK	CP162	\$120.00
+ 5V @ 1.7A/2.2A PK	- 5V @ .15A/.2A PK	+ 24V @ .2A/3A PK	CP272A	\$ 91.95
+ 5V @ 2A	+ 12V @ .4A	- 12V @ .4A	HTAA-16W	\$ 49.95

CP272A powers Persci Drives (includes unregulated 7 - 10V @ 1.2A/10A PK). HTAA-16W powers Persci controller.

POWER-ONE D.C. POWER SUPPLIES

Power One Drive • Camarillo, CA 93010 • (805) 484-2806 • TWX 910-336-1297
Eastern Regional Headquarters • (518) 399-9200

46 WAYS TO INCREASE YOUR COMPUTER & MICROPROCESSOR KNOW-HOW!

SEND NO MONEY! We'll invoice you on 10-DAY FREE TRIAL. ALL BOOKS 100% GUARANTEED. You must be satisfied or return the books and we'll cancel the invoice.

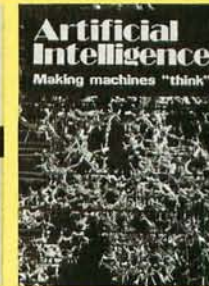
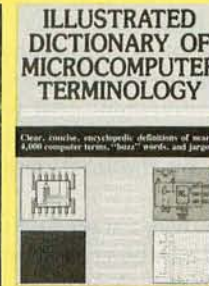

1169—The Giant Handbook of Computer Projects This MAMMOTH 504-page step-by-step guide to building modern computers and accessories—CPUs, memories, I/O hardware, etc.—is a builder's dream, with projects and schematics, parts lists, and step-by-step construction instructions to enable you to build your own systems. 504 p., 217 il. Only \$15.95 h; \$9.95 p.

1062—The A to Z Book of Computer Games 26 exciting and instructive game programs—all tested and ready to run, and designed to illustrate the fine points of computer programming! Each sophisticated program includes full documentation on how the game works, what the program contains, and how to alter or modify it... plus programming gems! 308 p., 73 il. Only \$12.95 h; \$7.95 p.

1053—Microprocessor Cookbook A chip-by-chip comparison of the most popular modern microprocessors—the Intel 8080, Motorola 6800, Fairchild's F8 family, Zilog Z80, TI's TMS 9900, National Semi SC/MP, Intel's 8021, etc.—including programming, architecture, addressing, instruction sets, functions, structures, and applications! 266 p., 124 il. Only \$10.95 h; \$5.95 p.

1111—How To Design, Build & Program Your Own Working Computer System THE complete computer build-it book, including design, construction, programming, testing and debugging! This 2-in-1 volume combines hardware and software so you can homebrew your own customized computer system at 1/3 the cost of an equivalent commercial unit! 308 p., 138 il. Only \$14.95 h; \$8.95 p.

1088—Illustrated Dictionary of Microcomputer Terminology Here are clear, concise, encyclopedic definitions of nearly 4,000 computer terms, "buzz" words, and jargon used in microcomputers. But it's more than just a dictionary—it's a thorough update on what's happening in computers and related peripheral systems. Includes tables, codes, etc. 322 p., 150 il. Only \$12.95 h; \$7.95 p.

1076—Artificial Intelligence An exciting, thought provoking guide to the sophisticated techniques used to make machines "think." It carefully defines artificial intelligence, explains the theory behind advanced computer programming, and shows you how to program your computer to assume the rudiments of humanlike intelligence. 252 p., 118 il. Only \$12.95 h; \$7.95 p.

1201—The Complete Microcomputer Systems Handbook. A complete guide to microcomputers—how they operate, how to use them, how to program them, and how to troubleshoot and repair them... plus data on applications and the latest state-of-the-art concepts like magnetic bubble memories, computers in networks, teaching machines to learn, etc. 322 p., 147 il. Only \$15.95 h; \$9.95 p.

1055—The Basic Cookbook. A step-by-step guide to writing and using micro- and mini-computer programs for everyday household, pastime, and business applications. Shows how to understand BASIC and write instructions, enter them into the computer, and interpret results. 140 p., 49 il. Only \$7.95 h; \$4.95 p.

1141—How To Build Your Own Working Robot Pet. A step-by-step guide to building and operating a robot pet. Includes technical data and info on interfacing the body, building the power system, building circuits, etc. 238 p., 86 il. Only \$10.95 h; \$6.95 p.

1099—How To Build Your Own Working 16-Bit Microcomputer. A step-by-step description of how to construct a working 16-bit microcomputer, using the 9900 CPU microprocessor. Covers every type of interface required, and how to use it. 96 p., 73 il. Only \$3.95 p.

861—Display Electronics. An experimenter's guide to optoelectronic circuits plus over 70 projects using arrays and displays, light-emitting diodes, infrared-emitting diodes, photodiodes, liquid crystals, phototransistors, light-activated SGRs, fiber optics, electroluminescence, and a host of other exotic display devices. 252 p., 195 il. Only \$8.95 h; \$5.95 p.

752—Computer Programming Handbook. A complete guide to computer programming and data processing, with scores of worked out examples. An extremely comprehensive, informative, and interesting work on digital computer programming, and data processing in general. This GANT text covers all three types of computer languages—machine, symbolic, and problem-oriented which focuses on FORTRAN IV. If ever there was a one-book course on computer programming this is it! 518 p., 114 il. Only \$12.95 h; \$9.95 p.

952—Microprocessor Programming For Computer Hobbyists. A modern, up-to-date handbook of intermediate and advanced programming techniques for hobbyists. Begins where manufacturer instructions usually stop—and covers everything, with important info on program design, number systems, high-level languages, data structures, program adaptation from machine to machine, etc. 378 p., 219 il. Only \$12.95 h; \$8.95 p.

971—Miniprocessors: From Calculators to Computers. Shows how to assemble and program a usable calculator system, from a simple arithmetic calculator to a fully programmable system with a randomly addressable 256-step memory. 196 p., 67 il. Only \$9.95 h; \$5.95 p.

955—Modern Digital Communications. Covers the latest techniques of transmission, coding, decoding, modulation, equalization and line conditioning, time division multiplexing, channel services, and all conversion methods involved in digital computerized communications. 308 p., 122 il. Only \$10.95 h; \$6.95 p.

874—Master Handbook Of Digital Logic Applications. A modern sourcebook of the latest design info on digital devices and logic systems, both discrete and IC. 392 p., 308 il. Only \$12.95 h; \$7.95 p.

709—Modern Guide To Digital Logic—Processors, Memories, And Interfaces. This modern guide contains up-to-date data on the most advanced logic circuits used in today's digital systems, and emphasizes the problem of interfacing high-speed logic with lower-speed logic and memory systems. 294 p., 222 il. Only \$9.95 h; \$7.95 p.

548—Beginner's Guide To Computer Logic. Without any prior knowledge you'll quickly grasp such seemingly complicated subjects as computer codes, digital logic operations, number systems, and switching circuits. Also includes logic circuits you can build, and thereby learn by doing. 192 p., 100 il. Only \$5.95 p.

1045—Programmer's Guide To LISP. A question-and-answer guide to learning the language of artificial intelligence—with actual programs and routines. Guides you through the basics of algebraic functions, expressions, atoms, symbols, lists, sublists, subexpressions, LISP functions and logic, LISP parameters and list processing, predicates, recursive functions, dot notation, list recursion, etc. 210 p., 117 il. Only \$9.95 h; \$5.95 p.

1101—How To Design And Build Your Own Custom TV Games. A complete guide to all kinds of TV games—how they work, how to play them, and how to design and build them. A number of complete game circuits, equipped with flowcharts, is included. 546 p., 244 il. Only \$14.95 h; \$9.95 p.

984—CMOS Databook. Everything you need to know about CMOS—all the theory, all the circuits, all the practical applications! A 100% practical course in understanding, using, and interfacing CMOS devices—covers everything from CMOS logic operations to basic analog circuits! Ignores the usual math treatment in favor of the day-to-day info used in actual design work. 280 p., 273 il. Only \$9.95 h; \$6.95 p.

975—The "Computer" Book—Build Super Calculators/Microcomputer Hardware With Calculator Chips. A "build-it" book that shows how to modify and greatly expand on what those inexpensive calculator chips can do. Includes scores of projects ranging from simple math functions to a microcomputer auxiliary unit with unlimited programming steps. 322 p., 224 il. Only \$7.95 p.

676—Simplified Computer Programming—Including The Easy RPG Way. This book really makes computer programming simple, and includes eight sample programming problems, complete with blank RPG forms and filled-in answer forms. 240 p., 177 il. Only \$6.95 p.

728—Basic Digital Electronics—Understanding Number Systems, Boolean Algebra, & Logic Systems. An extremely easy-to-understand "self-learning" guidebook to digital circuits, logic applications, number codes and systems—and a sensible comparison of the various logic families. 210 p., 117 il. Only \$4.95 p.

1071—The Complete Handbook Of Robotics. How to design and build ANY kind of robot... including ones with microprocessor "brains"—PLUS how to interface robots with computers! It's a single sourcebook that contains all the techniques you'll need for creating, designing, building, and operating your own robot. 364 p., 137 il. Only \$12.95 h; \$7.95 p.

1101—How To Design And Build Your Own Custom TV Games. A complete guide to all kinds of TV games—how they work, how to play them, and how to design and build them. A number of complete game circuits, equipped with flowcharts, is included. 546 p., 244 il. Only \$14.95 h; \$9.95 p.

984—CMOS Databook. Everything you need to know about CMOS—all the theory, all the circuits, all the practical applications! A 100% practical course in understanding, using, and interfacing CMOS devices—covers everything from CMOS logic operations to basic analog circuits! Ignores the usual math treatment in favor of the day-to-day info used in actual design work. 280 p., 273 il. Only \$9.95 h; \$6.95 p.

975—The "Computer" Book—Build Super Calculators/Microcomputer Hardware With Calculator Chips. A "build-it" book that shows how to modify and greatly expand on what those inexpensive calculator chips can do. Includes scores of projects ranging from simple math functions to a microcomputer auxiliary unit with unlimited programming steps. 322 p., 224 il. Only \$7.95 p.

774—Digital/Logic Electronics Handbook. Learn digital electronics, number systems, logic, and Boolean algebra while studying modern digital circuits for a clock, calculator, thermometer, multimeter, and interval timer in this down-to-earth book on logic and digital electronics...without the mass of formulas and equations found in many books, but with practical info. 308 p., 226 il. Only \$9.95 h; \$6.95 p.

1095—Programs In BASIC For Electronic Engineers, Technicians & Experimenters. A broad range of problem-solving programs in computer BASIC, including Beta Distribution, Chebyshev High-Pass and Low-Pass Designers, Fourier Analysis, Op-Amp circuits, etc. 140 p., 26 il. Only \$8.95 h; \$4.95 p.

1066—The Illustrated Dictionary Of Electronics. Complete, modern definitions for well over 20,000 electronics/computer terms! It's an all-inclusive dictionary of technical terms that is up-to-date, well-organized and concise, and designed to convey a clear meaning to any term. 882 p., 472 il. Only \$19.95 h; \$14.95 p.

1085—24 Tested, Ready-To-Run Game Programs In BASIC. A rich collection of challenging and interesting computer games, complete with detailed descriptions and flow charts for the computer hobbyist. 256 p., 31 il. Only \$9.95 h; \$6.95 p.

1241—How To Build Your Own Self-Programming Robot. Complete over-the-shoulder instructions on how to use the 8085 microprocessor to build Rodney Robot, a robot capable of thinking and learning. It's a straightforward how-to-introduction to the sophisticated subject of robotics and machine intelligence. 239 p., 103 il. Only \$12.95 h; \$7.95 p.

995—Beginner's Guide To Microprocessors. An in-depth intro to the microprocessor—how they work, and how they are programmed to perform desired functions. 182 p., 106 il. Only \$8.95 h; \$5.95 p.

676—Simplified Computer Programming—Including The Easy RPG Way. This book really makes computer programming simple, and includes eight sample programming problems, complete with blank RPG forms and filled-in answer forms. 240 p., 177 il. Only \$6.95 p.

728—Basic Digital Electronics—Understanding Number Systems, Boolean Algebra, & Logic Systems. An extremely easy-to-understand "self-learning" guidebook to digital circuits, logic applications, number codes and systems—and a sensible comparison of the various logic families. 210 p., 117 il. Only \$4.95 p.

1085—24 Tested, Ready-To-Run Game Programs In BASIC. A rich collection of challenging and interesting computer games, complete with detailed descriptions and flow charts for the computer hobbyist. 256 p., 31 il. Only \$9.95 h; \$6.95 p.

1070—Digital Interfacing With An Analog World. A guide to digital-to-analog and analog-to-digital interfacing—including the designing of circuits that will link microcomputers and larger systems with external devices. Covers energy conversion, transducers and transduction, digital circuits, digital data acquisition, etc. 406 p., 277 il. Only \$12.95 h; \$8.95 p.

995—Beginner's Guide To Microprocessors. An in-depth intro to the microprocessor—how they work, and how they are programmed to perform desired functions. 182 p., 106 il. Only \$8.95 h; \$5.95 p.

1069—Computerist's Handy Databook/Dictionary. Organizes and clarifies data, terms and computer talk, with clear explanations of all that makes up computer terminology—words, symbols, terms, abbreviations, charts, tables, codes, etc. 96 p., 42 il. Only \$3.95 p.

774—Digital/Logic Electronics Handbook. Learn digital electronics, number systems, logic, and Boolean algebra while studying modern digital circuits for a clock, calculator, thermometer, multimeter, and interval timer in this down-to-earth book on logic and digital electronics...without the mass of formulas and equations found in many books, but with practical info. 308 p., 226 il. Only \$9.95 h; \$6.95 p.

1095—Programs In BASIC For Electronic Engineers, Technicians & Experimenters. A broad range of problem-solving programs in computer BASIC, including Beta Distribution, Chebyshev High-Pass and Low-Pass Designers, Fourier Analysis, Op-Amp circuits, etc. 140 p., 26 il. Only \$8.95 h; \$4.95 p.

1070—Digital Interfacing With An Analog World. A guide to digital-to-analog and analog-to-digital interfacing—including the designing of circuits that will link microcomputers and larger systems with external devices. Covers energy conversion, transducers and transduction, digital circuits, digital data acquisition, etc. 406 p., 277 il. Only \$12.95 h; \$8.95 p.

985—Programming Microprocessors. Gives a basic understanding of microprocessor configurations and functions, and offers useful data on the requirements of programming them. Describes the interaction of hardware and software systems, the fundamentals of processor arithmetic, and numerical conversions. Plenty of diagrams, examples and problems are included. 280 p., 102 il. Only \$8.95 h; \$6.95 p.

1069—Computerist's Handy Databook/Dictionary. Organizes and clarifies data, terms and computer talk, with clear explanations of all that makes up computer terminology—words, symbols, terms, abbreviations, charts, tables, codes, etc. 96 p., 42 il. Only \$3.95 p.

554—Computer Technician's Handbook. How to check, troubleshoot, and maintain computer systems... from the smallest to the most complex. This giant volume is comparable to a 1000-hour course on computer maintenance. 480 p., 428 il. Only \$14.95 h; \$10.95 p.

774—Digital/Logic Electronics Handbook. Learn digital electronics, number systems, logic, and Boolean algebra while studying modern digital circuits for a clock, calculator, thermometer, multimeter, and interval timer in this down-to-earth book on logic and digital electronics...without the mass of formulas and equations found in many books, but with practical info. 308 p., 226 il. Only \$9.95 h; \$6.95 p.

1095—Programs In BASIC For Electronic Engineers, Technicians & Experimenters. A broad range of problem-solving programs in computer BASIC, including Beta Distribution, Chebyshev High-Pass and Low-Pass Designers, Fourier Analysis, Op-Amp circuits, etc. 140 p., 26 il. Only \$8.95 h; \$4.95 p.

1000—57 Practical Programs & Games In BASIC. A storehouse of useful and just plain fun game programs for everything from computing compound interest to I Ching to Craps. Each program contains a description of its capabilities and includes a typical program sequence and flowchart. All will run on any floating point BASIC. 210 p., 64 il. Only \$10.95 h; \$7.95 p.

1015—A Beginner's Guide To Computers And Microprocessors. This well-written volume introduces you to the fascinating world of the microprocessor—its capabilities, parts, functions, and programming. It's a plain-English introduction to understanding, building, and programming a microprocessor. 308 p., 207 il. Only \$9.95 h; \$6.95 p.

785—Microprocessor/Microprogramming Handbook. An authoritative, practical guide to the construction, operation, programming and applications of microprocessors. Covers every aspect—inside and out, and illustrates microprogramming techniques to build up program loops, subroutines, and handle interrupts from other peripheral devices. 294 p., 176 il. Only \$9.95 h; \$6.95 p.

1012—How To Design & Build Electronic Instrumentation. Shows how to design special circuits or adapt existing ones to perform a host of functions from simple amplification to sophisticated sensing. 420 p., 210 il. Only \$14.95 h; \$9.95 p.

585—Digital Electronics: Principles And Practice. A read-and-do-it-type lab/workbench handbook of practical basic theory and construction projects and experiments. 292 p., 191 il. Only \$8.95 h; \$5.95 p.

1015—A Beginner's Guide To Computers And Microprocessors. This well-written volume introduces you to the fascinating world of the microprocessor—its capabilities, parts, functions, and programming. It's a plain-English introduction to understanding, building, and programming a microprocessor. 308 p., 207 il. Only \$9.95 h; \$6.95 p.

1077—Handbook Of Remote Control And Automation Techniques. A complete guide to the application of electronic techniques to the solution of any remote control problem. Shows how to interface a microcomputer to control household devices. 294 p., 250 il. Only \$12.95 h; \$7.95 p.

1012—How To Design & Build Electronic Instrumentation. Shows how to design special circuits or adapt existing ones to perform a host of functions from simple amplification to sophisticated sensing. 420 p., 210 il. Only \$14.95 h; \$9.95 p.

585—Digital Electronics: Principles And Practice. A read-and-do-it-type lab/workbench handbook of practical basic theory and construction projects and experiments. 292 p., 191 il. Only \$8.95 h; \$5.95 p.

785—Microprocessor/Microprogramming Handbook. An authoritative, practical guide to the construction, operation, programming and applications of microprocessors. Covers every aspect—inside and out, and illustrates microprogramming techniques to build up program loops, subroutines, and handle interrupts from other peripheral devices. 294 p., 176 il. Only \$9.95 h; \$6.95 p.

1012—How To Design & Build Electronic Instrumentation. Shows how to design special circuits or adapt existing ones to perform a host of functions from simple amplification to sophisticated sensing. 420 p., 210 il. Only \$14.95 h; \$9.95 p.

585—Digital Electronics: Principles And Practice. A read-and-do-it-type lab/workbench handbook of practical basic theory and construction projects and experiments. 292 p., 191 il. Only \$8.95 h; \$5.95 p.

TRS-1—TAB Computer Tape. An exciting, ready-to-run collection of computer fun games for a standard TRS-80 computer. Anyone with access to this machine can use the CLOAD command and get hours of challenging fun. Contains 12 fun games—Wumpus, Sub Hunt, Sink the Bismark, Mouse Hunt, Capture the Alien, Star Warp, Bomb Disposal Squad, Biorhythm, Leap Frog, Computerized Hangman, Your Cheating Computer, and Auto Rallye. Only \$9.95.

785—Microprocessor/Microprogramming Handbook. An authoritative, practical guide to the construction, operation, programming and applications of microprocessors. Covers every aspect—inside and out, and illustrates microprogramming techniques to build up program loops, subroutines, and handle interrupts from other peripheral devices. 294 p., 176 il. Only \$9.95 h; \$6.95 p.

1012—How To Design & Build Electronic Instrumentation. Shows how to design special circuits or adapt existing ones to perform a host of functions from simple amplification to sophisticated sensing. 420 p., 210 il. Only \$14.95 h; \$9.95 p.

585—Digital Electronics: Principles And Practice. A read-and-do-it-type lab/workbench handbook of practical basic theory and construction projects and experiments. 292 p., 191 il. Only \$8.95 h; \$5.95 p.

785—Microprocessor/Microprogramming Handbook. An authoritative, practical guide to the construction, operation, programming and applications of microprocessors. Covers every aspect—inside and out, and illustrates microprogramming techniques to build up program loops, subroutines, and handle interrupts from other peripheral devices. 294 p., 176 il. Only \$9.95 h; \$6.95 p.

1012—How To Design & Build Electronic Instrumentation. Shows how to design special circuits or adapt existing ones to perform a host of functions from simple amplification to sophisticated sensing. 420 p., 210 il. Only \$14.95 h; \$9.95 p.

10-DAY FREE TRIAL—NO RISK COUPON

TAB BOOKS, Blue Ridge Summit, Pa. 17214

Please send me the books indicated below. [specify edition desired (p) paper or (h) hard]:

I enclose \$_____ Send postpaid.
 Invoice me on 10-day trial (plus shipping)

Book # Book # Book # Book #

Name _____ Phone _____

Company _____

Address _____

City _____ State _____ Zip _____

Pa. add 6% Sales tax. All orders outside USA must add 15% shipping and be prepaid.

BY-380

multiplied by the number of different movement costs of directional terrain. For example, if trails reduce the movement cost to one-half, and roads reduce the movement cost to one-third, on a map using the city metric scatter function, eight directional terrain masks would be required and the unit movement cost would have to be reduced to one-sixth of its original value. This reduced value must be divisible by the least-common multiple of the reduction factors.

Prohibited terrain, such as a river that occupies only the edges of a position and can be crossed only via a bridge, poses yet another problem. A bridge is an example of directional terrain that does not affect the movement cost. To include the effects of bridges, you must define a set of directional terrain premasks to be used in conjunction with all other terrain masks. To represent the effects of directional terrain that adds a constant factor to the movement costs, yet another set of premasks must be defined.

The most effective way to use these directional terrain masks is by modification of the basic scatter function. Consider a game situation where we have clear terrain (one movement factor), rough terrain (two movement factors), roads (one-half movement factor in the direction that the road travels), and bridges over rivers (restricted movement that does not alter movement cost). Let us also use the city metric.

First, we must scale all of our movement costs to reflect the lower cost for the ideal terrain. Thus, we have roads

(1), clear (2) and rough (4). Note that bridges are unaffected. Let T2 and T4 be the terrain masks for clear and rough terrain as described in part 1 of this article. Let I_d be the terrain mask for the ideal terrain in the d direction and let P_d be the terrain mask for the prohibitive terrain (eg: rivers without bridges) in the d direction, where $d=1, 2, 3, 4$. Both I_d and P_d will be 1 only if movement is allowed from that location in direction d for each position on the map. Note that $I_d(I,J)=I_d(I,J)$ AND $P_d(I,J)$ for all I and J .

Let us now define our modified scatter functions CSC' and CSC'' as follows:

$$\begin{aligned} CSC'(A(I,J)) = & A(I,J) \text{ OR } (I1(I,J+1) \text{ AND } A(I,J+1)) \\ & \text{OR } (I2(I,J-1) \text{ AND } A(I,J-1)) \\ & \text{OR } (I3(I+1,J) \text{ AND } A(I+1,J)) \\ & \text{OR } (I4(I-1,J) \text{ AND } A(I-1,J)) \end{aligned}$$

Similarly:

$$\begin{aligned} CSC''(A(I,J)) = & (I,J) \text{ OR } (P1(I,J+1) \text{ AND } A(I,J+1)) \\ & \text{OR } (P2(I,J-1) \text{ AND } A(I,J-1)) \\ & \text{OR } (P3(I+1,J) \text{ AND } A(I+1,J)) \\ & \text{OR } (P4(I-1,J) \text{ AND } A(I-1,J)) \end{aligned}$$

Finally, by replacing CSC in the mapping relation developed in part 1 with CSC' and CSC'' we get:

$$\begin{aligned} M_n = & M_{n-1} \text{ OR } CSC'(M_{n-1}) \\ & \text{OR } (T2 \text{ AND } CSC''(M_{n-2})) \\ & \text{OR } (T4 \text{ AND } CSC''(M_{n-4})) \end{aligned}$$

Summary

We have seen that many problems involving variable terrain may be solved through the use of scatter mappings, scatter sums, premasking, and postmasking. Fixed, prohibited, and ideal terrain, as well as no-exit conditions, have been discussed in reference to our general algorithm of successive scatter mappings. Three different scatter functions and distance-function metrics have been demonstrated for use with two different grids. Two different coordinate systems have also been presented for hexagonal-grid problems.

Since you will most likely want to code it in your favorite language, I have not tried to write this algorithm as a program. I will, however, make a few suggestions. Perform logical functions on groups of elements simultaneously. The rows and columns of the arrays used in the island problem lend themselves nicely to implementation as 8-bit bytes of data. By using a little judicious shifting of these bytes, entire arrays can be scattered with only a few operations.

Do not be afraid to waste a few bits of storage or perform a few unnecessary logical operations to gain a more general representation of your map. It is easier to employ a buffer of unused elements around your arrays than to check for array subscripts that are out of range. Notice how the water terrain provided just such a buffer in the island problem.

In conclusion, this graphical approach to terrain problems provides a viable solution for a wide range of applications, not the least of which is conflict simulation. ■



computer mart
of new jersey

the
microcomputer
people®

THE VITAL
INGREDIENT:
EXPERTISE

Before you buy your new microcomputer, chances are you have a lot of questions. Important questions that could mean the difference between a working system and a wasted system. The vital ingredient is expertise. The microcomputer people at Computer Mart are expert at answering your questions and helping you put together the best system for your application. Whether it's for business, the home, or the laboratory, come see the experts at Computer Mart of New Jersey. We have the vital ingredient.

Computer Mart of New Jersey
501 Route 27
Iselin, N.J. 08830
(201) 283-0600

HOURS:
Open at 10 am.
Tuesday through Saturday

THE CONDUCTOR™

5 AND 8 INCH SINGLE-AND DOUBLE-DENSITY CONTROLLER ON ONE BOARD

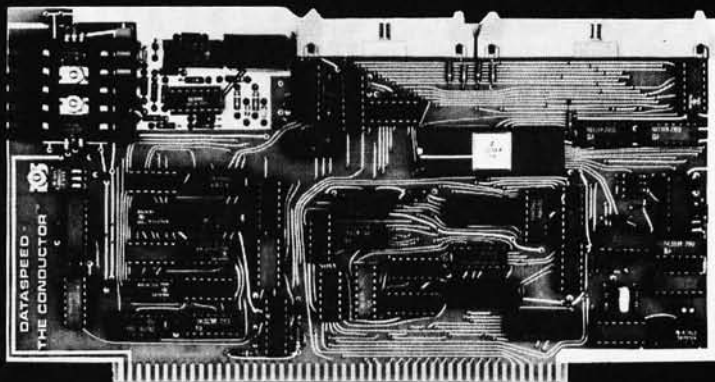

S-100 BUS PRODUCTS

THE CONDUCTOR™

A versatile dual density floppy disk controller. Backed up with dual density CP/M™ (\$150) and available NOW!!!

° **\$325** assembled

VIDEO CONTROLLER

Memory mapped 80 x 24 with dual character sets (programmable!) user rom space and HARDWARE SCROLLING. Firmware available.

\$349 assembled

DISK SYSTEMS

All the hardware you need for a COMPLETE floppy disk system. PLUS—FREE Osborne Accounting software. Just add CP/M and a computer

complete systems **\$795**

SEE US AT THE
WEST COAST COMPUTER FAIRE

All DATASPEED products are fully assembled and tested and warranted.

DATASPEED, INC.,
1300 NOE ST.
SAN FRANCISCO
CA. 94131
(415) 641-8947

TRS-80 Performance Evaluation by Program Timing

James R Lewis
4051 Mountain Dr
San Bernardino CA 92407

I have been asked to evaluate the performance characteristics of numerous hardware and software computer products in my capacity as a systems programmer. In late 1978 I acquired a Radio Shack TRS-80 personal computer system with Level I BASIC and 4 K bytes of memory. I did not consider a performance evaluation; after all, this was my own toy. I did not have to respond to any requests for performance improvements or evaluations. Only my personal satisfaction was important.

As it turned out, I was satisfied, but my friends and colleagues were not. They were continually asking,

Listing 1: Prime-number generator written in Level I BASIC for the TRS-80. No attempt was made here to optimize the speed of execution.

```
30 PRINT " LIST OF PRIME NUMBERS"
40 PRINT
50 PRINT 1;2;3;
55 C=0
70 M = 3
80 M = M + 2
90 FOR K = 3 TO M/2 STEP K - 1
100 IF INT(M/K)*K - M = 0 THEN 190
110 NEXT K
121 PRINT M;
122 C=C+1
190 IF M < 10000 THEN 80
195 PRINT "C = ";C
200 END
```

Listing 2: Level I BASIC version of the prime-number generator in which abbreviations were used and explanatory material omitted to increase speed. Such practices are termed "optimization."

```
80 F.M=5TO10000S.2
90 F.K=3TOM/2S.2
100 IF I.(M/K)*K=MT.N.M
110 N.K
120 P.M;
190 N.M
```

"How fast does your toy run?" or "What new tricks have you taught it now?" It seemed that a comprehensive performance testing and evaluation plan was called for. I decided to compare my TRS-80 personal computer with one of the IBM computers (a System/370-148) at work. Since I was also in the process of converting from Level I to Level II BASIC and acquiring more hardware, I wanted to see if I could verify the performance improvements claimed by Radio Shack.

Test Problem

The test problem to be solved was one familiar to computer science students: calculation of prime-number integers from 5 to 10,000. This problem was chosen for several reasons. First, it is a problem that many computer programmers can relate to; second, it uses two program loops; and third, it requires calculations more complex than simple addition. The number of microseconds or nanoseconds required to perform a single function like addition does not adequately describe the performance characteristics of an individual computer, nor does comparison of timing determine the difference between two machines. What is needed is a comparison of a group of instructions or the use of a program representative of those which will be used extensively on that computer as the comparison base. The problem used here performs loops, does moderately complex arithmetic calculations, and performs some input/output (I/O) operations.

Test Problem and the TRS-80 Level I

Listing 1 gives the BASIC statements from my first coding of

the test problem. Note that each keyword of the program was completely entered and spelled out in full, without regard to the abbreviations allowed in Level I. This code took 8 hours and 12 minutes to run to completion (see table 1 for a complete comparison of the results). By simply using the keyword abbreviations (ie: F. instead of FOR and N. instead of NEXT, shown in listing 2), the run time was cut to 7 hours and 12 minutes. The extra N.M (NEXT M) statement was used to speed up the loops, but at the completion of the problem run, a FOR-NEXT error results. This is okay because the problem has been completed.

Listing 3: Level II BASIC version of test program. Keywords must be spelled out in Level II, but the use of integer variables makes it faster than the optimized Level I program. Level II BASIC is also an interpretive system.

```
10 DEFINTM,K
80 FORM=5TO10000STEP2
90 FORK=3TOM/2STEP2
100 IFINT(M/K)*M=MTHENNEXTM
110 NEXTK
120 PRINTM;
190 NEXTM
```

The first performance conclusion has been reached; abbreviated syntax cut an 8-hour program by 1 hour. This gave me a 12% improvement in throughput, the magic measure of system performance. Now the problem solution can be accelerated with faster software. For \$99 you can go back to fully spelled out keywords and still gain speed. [Although Level II BASIC requires that keywords be entered in the fully spelled out form, and displays them in that way, the keywords are stored in memory in the

SYNCHRO-SOUND

The ORIGINAL Computer People
who KNOW Computers
and offer EVERYTHING you need
in Small Computer Systems



TERMINALS

ADDS Regent 25

LEAR SIEGLER

ADM 3A
ADM 31
ADM 42

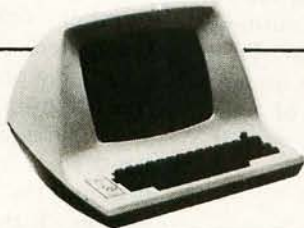

HAZELTINE

1400	1500	Mod 1 Edit
1410	1510	
1420	1520	



PRINTERS

QUME Sprint
5/45 KSR
5/55

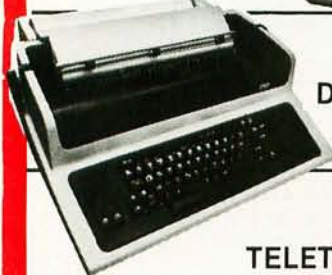

DECwriter IV
LA 34

TELETYPE
43



CENTRONICS

779-2 | 703-0
700-2 | 730



A PERFECT
SUPER SPECIAL MATCHED PAIR!



Texas Instrument
810 Multi Copy
Impact Printer
150 characters per sec.
bi-directional printing



Intertec
Super Brain
Computer Terminal
Dble. Density Dual Mini-
Floppies, CPM based
Development or Business System

ONLY \$3995.

COMPUTERS

DIGITAL SYSTEMS

DSC 2
Dble. Density
Dual Drive Disk



NORTHSTAR
HORIZON II
HORIZON II Quad

CROMEMCO
System 3



ATARI
400
800

MORE SPECIALS

Okidata SL125	\$2595.00	Livermore Acoustic Coupler	\$249.00
Okidata SL300	2995.00	Centronics Micro Printer	349.00
Persci 277 Dble Density	1395.00	5" Scotch Diskette Box	34.95
Imsai PCS 80/15	499.00	8" Scotch Diskette Box	39.95
Televideo 912, 920	CALL		

MANY OF OUR PRICES ARE TOO LOW
TO ADVERTISE. PLEASE CALL OR WRITE

We carry a full line of Alpha-Micro Products.
We have a full staff of Programmers and Computer
Consultants to design, configure and deliver a Turnkey
Computer System to meet your specific requirements.



SYNCHRO-SOUND

ENTERPRISES, INC.

THE COMPUTER PEOPLE
193-25 Jamaica Ave., Jamaica, New York 11423 • TWX 710-582-5886

PHONE ORDERS, CALL:
New York-212/468-7067
Los Angeles-213/628-1808
Chicago-312/641-3010
Dallas-214/742-6090

form of single-byte codes. A translation routine is used to spell out the meaning of these codes when the LIST command is given.... RSS]

Test Problem and Level II BASIC

I sent back my TRS-80 Level I 4 K computer. A short time later it came back with Level II BASIC and an expanded 16 K bytes user memory. The original test problem now ran in 6 hours and 31 minutes. This improvement was approximately 9%; there was an \$11 investment for each percent of performance gained.

Test Problem and Z80 Assembly Language

Several years ago I became proficient in Datapoint 2200 assembly language, which is very similar to Z80 assembly language. I thought that several hours of coding and testing would be required to implement the test problem in Z80 assembly instructions. After several days of relearning the microinstruction format and developing the conversion and division subroutines, I finally ran my assembly test. To my surprise, it now ran in just under 22 minutes, an improvement of over 6

hours. Note that in the assembly-language program multiplication was not required, because all that is needed for prime number detection is division and determination of the remainder. The quotient proved useful in controlling the inner loop.

My next expansion of the system added a floppy-disk drive and more memory to a 32 K bytes total. There was an apparent five-second reduction in run time when the prime number output conversion was eliminated. However, I observed no noticeable performance change when the program ran in either the first 16 K bytes of memory or in the second 16 K bytes. Now that I had a disk and the TRSDOS disk operating system, I thought of the real-time CLOCK function now activated and wondered about its effect on performance.

Test Problem and the TRSDOS Disk Operating System

I relocated my assembly-language program to hexadecimal location

Test	Listing	Run Time			Description
		hours	minutes	seconds	
1	1	8	12	13	TRS-80 Level I Nonoptimized BASIC
2	2	7	12	27	TRS-80 Level I Optimized BASIC
3	3	6	31	10	TRS-80 Level II BASIC
4	4		21	55	Z80 Assembler Language
5	4		22	50	Z80 Assembler Language under TRSDOS Disk Operating System
6	5	1		19	PL/I for IBM 370-148 using Optimizing Compiler
7	6			56	370-148 Assembly Language IBM 370-148 Assembly Language

Table 1: Summary of tests in our performance evaluation. In each case the program found integer prime numbers from 5 to 10,000.

Text continued on page 92

FINALLY, Apple II[®] software for the discerning computerist, and the not-so-discerning beginner

AppleAids[™]

Little Tricks[™]

A series of carefully explained subroutines containing a potpourri of useful programming techniques in Integer Basic and Applesoft, such as specific key stroke identification, timing loops, disappearing question marks on input, no question marks on input, and many more.

Cassette (24K) 14.95 Disk (32K) 19.95

Scroll Control[™]

Have you ever wondered why you cannot list an Integer Basic or Applesoft program one screen-page at a time? So have we, and we did something about it! Our machine language Scroll Control, hidden in RAM so as not to "bump" into your program, can be engaged or disengaged at a flick of the keyboard. Why be frustrated when instead you can control the scroll? Cassette 9.95 Disk 14.95

CompuLaw[™] Series

*Alitax Estimator[™]

This Applesoft program, prepared under the supervision of an attorney, estimates disposable income after alimony and child support payments and federal taxes. For use by laymen and attorneys. 1980 tables.

Cassette (24K) 9.95 Disk (32K) 14.95

*Pensioner[™]

A companion to Alitax Estimator in Applesoft designed to calculate the present value of a pension in states in which a pension is subject to division in marital dissolution cases.

Cassette (24K) 9.95 Disk (32K) 14.95

N.J. res. add 5% sales tax
Apple II and Applesoft are registered trademarks of Apple Computer, Inc.
Add \$1.50 /item, shipping and handling
*professional, but not a substitute for legal advice

Form-It-Out[™]

A series of routines in Integer Basic and Applesoft containing detailed explanation and examples of programming techniques necessary to professionalize your screen output. Included are right and center justification, windowing, tabbing, cursor positioning among others.

Cassette (24K) 14.95 Disk (32K) 19.95

Track & Sector List[™]

This is the ultimate disk utility. Instead of a catalog, have you ever seen those dreaded words "I/O ERROR"? Is all lost? NO! Now your disk may be saved. Also you can eliminate bad sectors, remove control characters imbedded in file names, and more. This machine language program is supplemented by extensive tutorial documentation worth its weight in gold. Disk only (32K) 29.95

Hex and Decimal Learning Tree[™]

My ABC's[™]

An early learning Integer Basic program using over one hundred and fifty high resolution graphic letters and pictures in a drill-and-practice format designed to develop identification of capital and small letters, and association of letters with pictures. Scoring capability allows monitoring Child tested and teacher recognized. Cassette (48K) 14.95 Disk 19.95

Now I Can Rhyme[™]

A companion to My ABC's in Integer Basic. The child selects those high resolution pictures which rhyme. Score-keeping capability allows monitoring. Incorporates progressive levels of difficulty. Cassette (48K) 14.95 Disk (48K) 19.95

SOFTAGON
INCORPORATED

P.O. Box 774 M
Morristown, NJ 07960
(201) 539-3770



The Source for 6800/6809 Software

Technical Systems Consultants, Inc. is The Source for your 6800/6809 systems software needs. From FLEX™, the standard disk operating system of the 680X family, to Sort/Merge, your systems requirements can be filled with the highest quality software in the industry. Nowhere else can you find such variety from a single source. Here are some of the most popular:

Program Name	6800	6809
FLEX for SWTPc	\$90	\$90
FLEX for SSB	90	90
Extended BASIC	100	100
Extended BASIC Precompiler	50	50
BASIC	65	65
BASIC Precompiler	40	40
FLEX Sort/Merge	75	75
Text Editing System	40	35
Assembler	40	40
Text Processing System	60	N/A
Debug Package	55	75
FLEX Utilities	100	60

These packages are available on either 8" or 5" soft-sectored FLEX diskettes (5" 6800 is FLEX 2.0). Price includes user's manual and object code diskette. Price includes user's manual and object code diskette. Certain programs are available on cassette. Contact Technical Systems Consultants for pricing. All orders should include 3 percent for postage and handling (8 percent on foreign orders). Master Charge and Visa are welcome.

*FLEX is a trademark of Technical Systems Consultants, Inc.



**technical systems
consultants, inc.**
Box 2574, West Lafayette, IN 47906
(317) 463-2502

MICROPRO

BRAG, BR



AG, BRAG,

...“MicroPro’s I/O Master and Word-Star made my company’s new word processing system...
A WINNER!”

Yes! From the company that brought you WORD-STAR, the finest word processing software ever seen on a Z-80, 8085, or 8080 micro computer. You can now get the I/O Master, an S-100 board that allows the use of the OEM version of the NEC, DIABLO or QUME printer. The board also contains two FIFO buffered serial ports.

- Get 30% faster printer performance.
- Enables you to use a lower cost version of a high quality printer.
- No dropping of key strokes regardless of other system activity.
- Greater flexibility in the configuration of your word processing system.

All these advantages and you spend LESS than you would for any comparable equipment.

For more information call MicroPro and get the name of your nearest MicroPro dealer and let him... BRAG, BRAG, BRAG

The more you know... the more you'll buy...

MICROPRO

INTERNATIONAL CORPORATION

1299 4th Street, San Rafael, California 94901
Telephone (415) 457-8990 Telex 340388

X-RATED Revolutionary Computerized Math!

```

Enter: ? SOLVE (X+3 = A+2*X, X);
muMATH Responds:
@ X = -A,
  X = A,
  X = 0
Enter: ? TAN (X) * COS (X) + 1/CSC (X);
Response:
@ 2 * SIN(X)
Symbolic Integration!
? INT (X * COS(A * X^2), X);
@ SIN (X^2 * A) / (2 * A)
Symbolic Matrix Inversion!
? [1, X]
  [0, A] + -1;
@ [1, -X/A],
  [0, 1/A],
Exact Arithmetic!
? 991 * 9 + (1/2) / 40 + 35;
@ 296438922463401814427834899493
  2562055695871443300411356128843
  2003904069287504517225987785830307
  497936652596433351 / 1250000000000
    
```

muMATH™

- These examples illustrate only a few of the many *symbolic* math capabilities of muMATH. Note that it is not limited to *numerical* evaluation as in BASIC or PASCAL.
- Available for 8080, 8085 and Z80 processors using standard CP/M*, CDOS* and IMDOS* operating systems.
- Engineers and scientists find it ideal for deriving or checking lengthy analytical results.
- Students and teachers agree it is superb for math education from exact arithmetic through calculus.
- Hobbyists have discovered the underlying muSIMP programming system perfect for other artificial intelligence applications.
- Also available from The Soft Warehouse is a sophisticated LISP language interpreter for the above processors and operating systems.
- All software with extensive documentation is immediately available.
- Call or write directly for fast response.

* Manufacturers' registered trademarks.



©Copyright The Soft Warehouse 1980

Listing 4: Prime-number generator coded in Z80 assembler for the TRS-80. The Radio Shack Editor and Assembler package was used. The efficiency of assembler coding is clearly shown in the greatly reduced execution time. No interpretation is required; we are speaking in the "native language" of the machine.

```

START   ORG     7000H
        LD     HL,(NUM)           ;GET NUMBER
        INC   HL                 ;BUMP NUMBER
        INC   HL                 ;BY TWO TO INSURE ODD VALUE
        LD     (NUM),HL          ;SAVE FOR NEXT TIME
        LD     A,10000<8<-8     ;LSB OF 10000
        SUB   L                 ;DOUBLE PRECISION COMPARE
        LD     A,10000<-8       ;MSB OF 10000
        SBC   A,H               ;CHECK HIGH BYTE
        JR    C,DONE            ;END OF RUN
        LD     DE,1             ;START VALUE
        LD     (NUM2),DE        ;SAVE IT

;
DLOOP   LD     DE,(NUM2)        ;DIVISOR
        INC   DE                 ;BUMP IT
        INC   DE                 ;TWICE TO KEEP ODD
        LD     (NUM2),DE        ;SAVE FOR NEXT TIME
        LD     BC,(NUM)         ;TARGET
        LD     HL,0             ;CLEAR HIGH HALF OF DIVIDEND
        CALL  DIV16            ;PERFORM 16 BIT DIVIDE
        LD     A,H              ;CHECK REMAINDER
        OR    L                 ;IF ZERO WAS DIVISIBLE
        JR    Z,START          ;AND NOT PRIME
        DEC   BC               ;CHECK FOR ONE
        LD     A,B              ;AS THIS MEANS WE
        OR    C                 ;HAVE GONE HALFWAY
        JR    NZ,DLOOP         ;NO, LOOP
        LD     HL,(NUM)         ;DISPLAY THIS NUMBER
        LD     IX,WORK          ;WORK AREA
        CALL  DCONV            ;CONVERT TO ASCII
        LD     HL,WORK          ;AREA FOR DISPLAY
        CALL  DSPLY            ;TO SCREEN
        LD     HL,(COUNT)     ;COUNT PRIME NUMBERS
        INC   HL                ;BY ONE
        LD     (COUNT),HL
        JR    START

;
DONE    LD     HL,(COUNT)     ;DISPLAY TOTAL COUNT
        LD     IX,WORK          ;WORK AREA
        CALL  DCONV            ;CONVERT TO ASCII
        LD     HL,TOTAL        ;DISPLAY STRING
        CALL  DSPLY            ;TO SCREEN
        JR    $                ;LOOP

;
TOTAL   DEFM   'TOTAL ='
WORK    DEFM   '12345 '
        DEFB   3
NUM      DEFW   1                ;NUMBER TO BE TESTED
NUM2     DEFW   0                ;TESTING NUMBER
COUNT   DEFW   0                ;COUNT OF PRIME NUMBERS
;
DCHAR   EQU    33H              ;DISPLAY STRING TO SCREEN
DSPLY   LD     A,(HL)           ;LEVEL II CHAR DISPLAY
        CP    3                 ;GET CHARACTER
        RET   Z                 ;END OF STRING?
        CALL DCHAR              ;YES, DONE
        INC   HL                ;LET LEVEL II MANAGE SCREEN
        JR    DSPLY            ;BUMP MEMORY POINTER

;
DCONV   LD     C,' '            ;CONVERT HL TO 5 DIGIT AREA POINTED TO BY IX
        LD     B,5              ;TRIGGER AND ASCII CHARACTER
        LD     IX,CTBL          ;COUNT OF CONVERSION
        LD     E,(IX)           ;CONVERSION TABLE
        INC   IX                ;LSB OF FACTOR
        LD     D,(IX)           ;MSB OF FACTOR
        INC   IX
        SUB   A                 ;CLEAR C FLAG AND DIGIT COUNTER
        SBC   HL,DE            ;16 BIT SUBTRACT
    
```

Listing 4 continued on page 92

OLIVETTI PRINTERS

AVAILABLE NOW!

For years we have been our own biggest customer. Until now you couldn't buy an Olivetti printer unless you bought a complete Olivetti calculator. Now, for the first time, our complete line of OEM printers is available for immediate shipment in any quantity. For use in calculators, electronic scales, cash registers, mini computers, CRT hard copy output, data loggers, medical and scientific instruments, or any application where a paper tape printout is desired. Olivetti has a quality OEM printer for you.

For Further Information Please Contact:

Olivetti Corporation/OEM Marketing
 20370 Town Center Lane
 Cupertino, California 95014
 Telephone: 408/996/3867

Features:

- High Speed
- Low Cost—The Best Really Can Cost Less!
- Fewer Moving Parts
- Proven High Reliability and Long Life
- Over 3 Million In Use by Olivetti Alone
- Lightweight and Compact—Extremely Versatile
- Available With 6V or 18V Motor
- Low Power Usage
- Graphic Capabilities (PU1828 and PU1840)
- All Printers are Available With or Without Interface Boards

PU1840—
 40 Column Thermal, 240 L.P.M.
 Dot Matrix, Plotter

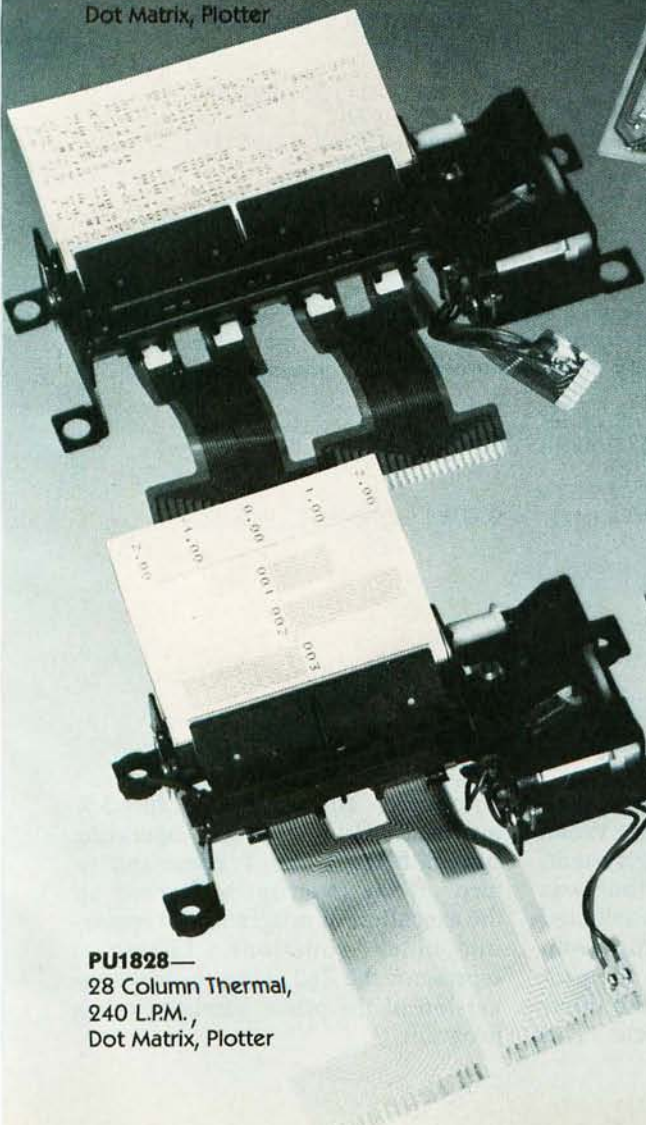

PU1808—
 16 Column Thermal, 120 L.P.M.

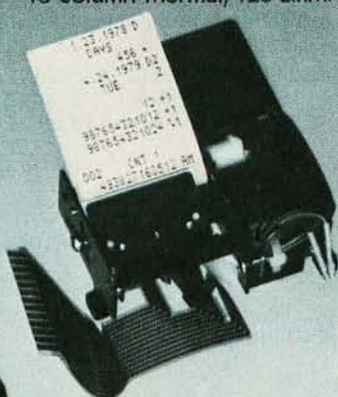

PU1800—
 20 Column Thermal, 120 L.P.M.

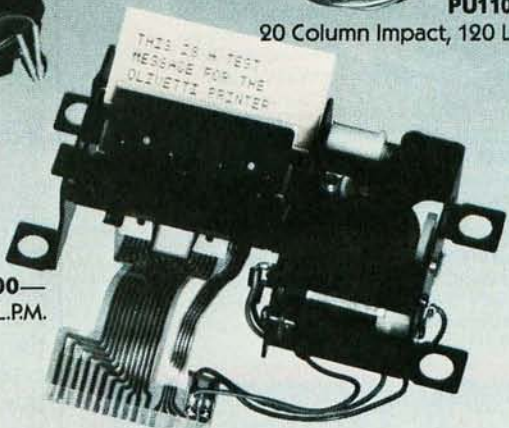

PU1100—
 20 Column Impact, 120 L.P.M.

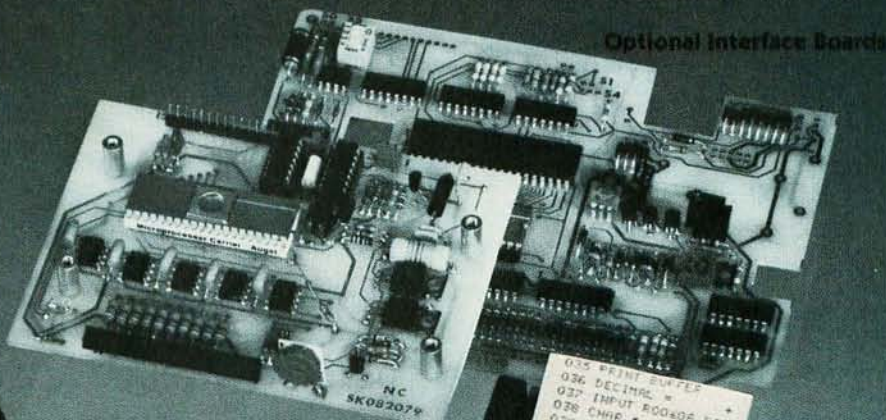
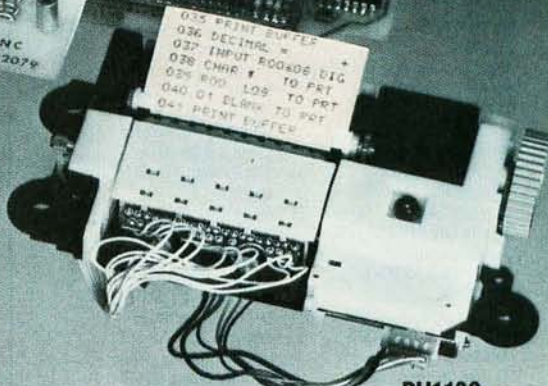

Optional Interface Boards

Coming Soon:
 80 Column Thermal, 240 L.P.M.
 Dot Matrix, Plotter

olivetti

Circle 55 on inquiry card.

SEE CORVUS HIGH PERFORMANCE PERIPHERALS AT THESE SELECTED DEALERS

ARIZONA

Computerland
Phoenix 602/956-5727

CALIFORNIA

Computer Warehouse
Bakersfield 805/397-7555

Computer Place
Carmel 408/624-7111

Computerland
Los Altos 415/941-8154

Computers Are Fun
Los Angeles 213/475-0566

Computer Merchant
San Diego 714/583-3963

Microbyte Computer Store
San Jose 408/377-4685

Computerland
San Rafael 415/459-1767

Computer City
Santa Ana 714/549-7749

The Computer Store
Santa Monica 213/451-0713

COLORADO

Computerland
Denver 303/759-4685

CONNECTICUT

The Computer Store
Stamford 203/356-1920

DELAWARE

Computerland
Newark 302/738-9656

FLORIDA

Computer Village
Miami 305/266-5965

Gulf Coast Computer
Milton 904/994-8506

GEORGIA

Advanced Computer Technology
Atlanta 404/255-8984

ILLINOIS

Farnsworth Computer
Aurora 372/851-3888

Personal Computing
Chicago 312/337-6744

Computer Station
Granite City 618/452-1860

Computerland
Mundelein 312/949-1300

IOWA

Lyon Co., Inc.
Jefferson 515/386-4275

LOUISIANA

Microcomputers
New Orleans 504/821-0870

MASSACHUSETTS

The Computer Store
Cambridge 617/354-4599

MICHIGAN

Level IV
Detroit 313/525-6200

MINNESOTA

Personal Business Systems
Minneapolis 612/929-4120

MISSOURI

Computer Country
Florissant 314/921-4433

Computers—ASP
Kansas City 816/741-8013

Forsythe Computers
St. Louis 314/721-4300

NEBRASKA

Altair Computer
Lincoln 402/474-2800

NEW JERSEY

Computer Mart
Iselin 201/283-0600

Computer Encounters
Princeton 609/924-8757

NEW MEXICO

South West Computer
Las Cruces 505/526-2842

NEW YORK

Byte Shop East
Levittown 516/731-8116

Computer Factory
New York 212/687-5001

Datel Stores
New York 212/921-0110

Computer Store
Rochester 716/244-5000

NORTH CAROLINA

Standard Computers
Charlotte 704/399-0228

Byte Shop
Raleigh 919/833-0210

OHIO

Personal Computers
Columbus 614/475-2007

OKLAHOMA

Contemporary Sounds
Enid 405/233-3883

SOUTH CAROLINA

Byte Shop
Columbia 803/771-7824

TEXAS

Computer Corner
Amarillo 806/355-5618

The Compushop
Dallas 214/234-3412

KA Electronic Sales
Dallas 214/634-7870

Computer Solutions
San Antonio 512/341-8851

UTAH

Inkley's
Salt Lake City 801/486-3921

VIRGINIA

Computer Works
Harrisonburg 703/434-1120

The Computer Place
Roanoke 703/982-3661

Home Computer Center
Virginia Beach 804/340-1977

WASHINGTON

Computerland Store
Federal Way 206/927-8585

WEST VIRGINIA

Computer Corner
Morgantown 304/292-9700

WISCONSIN

Blue Lakes Computer
Madison 608/257-4424

CANADA

Corvus of Canada
705/474-5823

GREAT BRITAIN

Keen Computers
602/583254

Listing 4 continued:

```

                JR      C,DCONV3          ;UNDERFLOW
                INC     A                  ;BUMP DIGIT
                JR      DCONV2          ;CONTINUE BUILDUP
DCONV3  ADD     HL,DE          ;COMPENSATE FOR UNDERFLOW
                OR      A                  ;NON-ZERO DIGIT?
                JR      Z,DCONV4        ;NO, ZERO, DO NOT RESET TRIGGER
                LD     C,'0'          ;ASCII TRIGGER
DCONV4  OR      C                  ;TURN INTO ASCII (OR BLANK)
                LD     (IX),A          ;STORE DIGIT
                INC     IX
                DJNZ   DCONV1          ;COUNT DOWN
                LD     A,(IX-1)        ;MUST SHOW A ZERO DIGIT
                OR     '0'            ;IF ZERO
                LD     (IX-1),A
                RET
;
; CTBL      DEFW  10000
;           DEFW  1000
;           DEFW  100
;           DEFW  10
;           DEFW  1
; 16 BIT DIVISION
;      DIVIDEND = HLBC
;      DIVISOR = DE
;      QUOTIENT = BC
;      REMAINDER = HL
DIV16   LD     A,16
DIV161  SLA    C
                RL     B
                ADC   HL,HL
                SBC   HL,DE
                JR    NC,DIV162
                ADD   HL,DE
                JR    DIV163
DIV162  INC    C
DIV163  DEC    A
                JR    NZ,DIV161
                RET
;
                END      START

```

Listing 5: Test program coded in the PL/I language for the IBM System/370-148. An optimizing compiler was used to run this version. Compilation is more efficient than interpretation in reducing execution time. This program also finds prime numbers.

```

PRIME: PROC OPTIONS(MAIN) REORDER;
      DECLARE (C, D, M) FIXED BINARY(31) INIT(0);
      DO M = 3 TO 10000 BY 2;
          DO D = 3 TO M/2 BY 2;
              IF MOD(M, D) = 0 THEN GOTO NOT__PRIME;
          END;
          C = C + 1;
          PUT LIST(M);
      NOT__PRIME:
          END;
          PUT SKIP DATA(C);
      END PRIME;

```

Text continued:

7000 and constructed a disk operating system command (CMD) file. When run under the disk operating system, the test problem execution time was extended by 55 seconds. I attributed this delay to the 25 ms interrupt from the expansion interface and the processing required to service the interrupt and update the clock. This

amounted to about 4 to 5% overhead. Using the disk operating system BASIC, the T command to turn off the interrupt will speed up the execution of programs not requiring clock functions. Listing 4 represents the Z80 assembly-language version of the prime number finding program.

Circle 56 on inquiry card.

CORVUS SYSTEMS, Inc.

900 S. Winchester Boulevard, San Jose,
California 95128 (408) 246-0461

World leader in Winchester disk systems, Winchester
backups, and other intelligent peripherals.

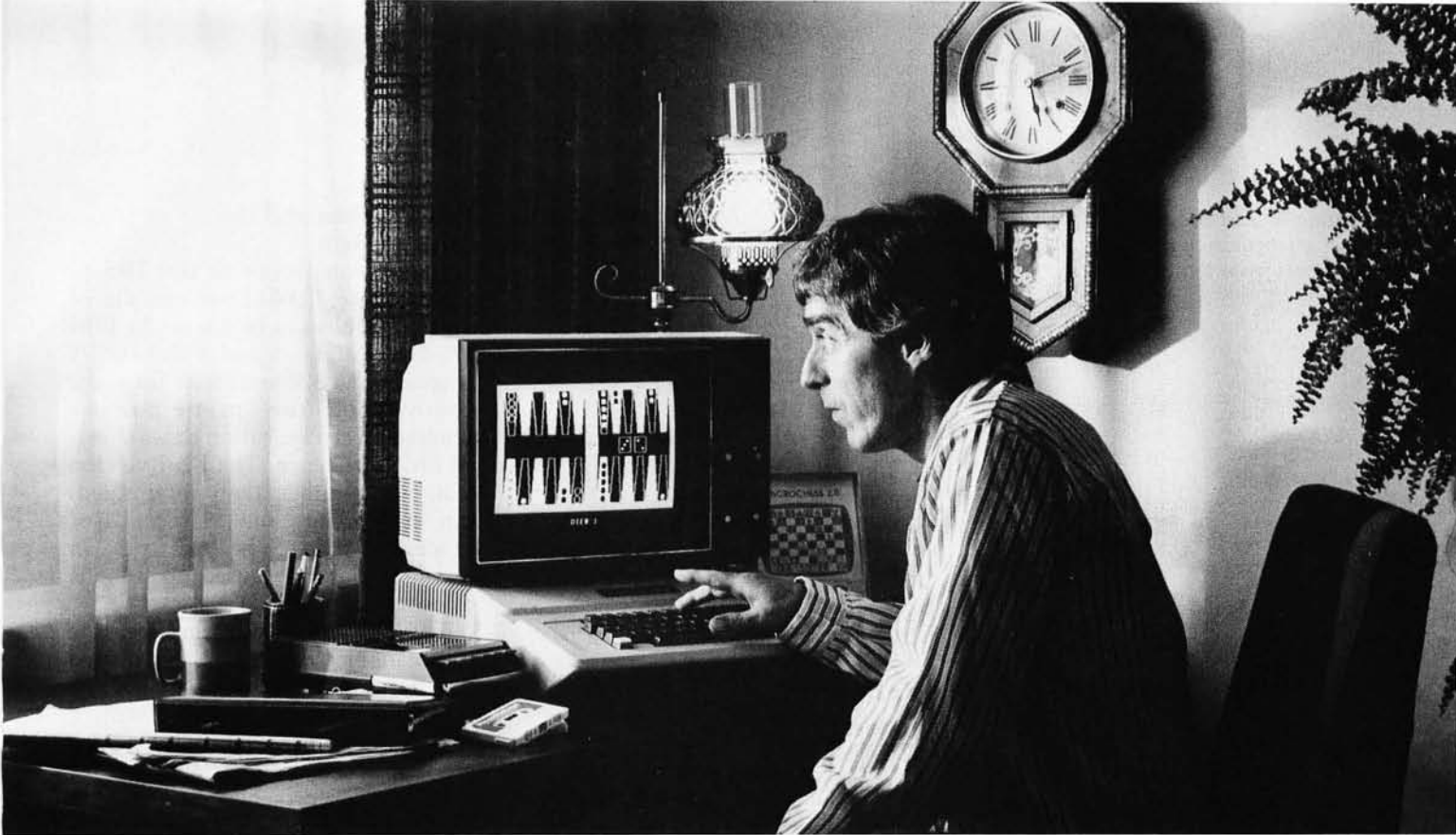

Even at 5:12 a.m., it's hard to quit playing Personal Software™ strategy games.

A quick game before turning in can become an all-night session when you load any of the Personal Software™ strategy games into your Apple,* PET* or TRS-80.* They'll challenge, teach and entertain you. And now there are two new games—Gammon Gambler™ and Checker King™—joining Bridge Partner,™ Time Trek™ and the best-selling Microchess.™

Gammon Gambler is a sure bet. With ten levels of skill, you can begin a novice and become an expert. Whichever level you play, the computer moves so quickly you don't have to wait. The program follows U.S. tournament rules, and includes the doubling cube to spice up the game. Written for the Apple and PET by Willy Chaplin.

Checker King—you probably forgot how much fun it is! If you move and change your mind, take it back and move again—without a peep from the computer. Play eight skill levels. Add and remove pieces. Save three board positions for later play. And solve three challenging checker puzzles. Written by Michael Marks for the Apple, PET and TRS-80.

Microchess, the most widely used personal computer chess program, is a nearly perfect chess opponent for the total novice or the advanced enthusiast. Written by Peter Jennings for the Apple, PET and TRS-80.

*Apple is a trademark of Apple Computer, Inc.; PET is a trademark of Commodore Business Machines, Inc.; TRS-80 is a trademark of the Radio Shack Division of Tandy Corp. Circle 57 on inquiry card.

Bridge Partner. You against the computer in over 10 million different hands of contract bridge. You can even specify the hands' high card points. Written by George Duisman for the Apple, PET and Level II TRS-80.

Time Trek is easy to learn, difficult to master and impossible to forget. Take command of a starship in real-time action to make the galaxy safe again. PET version by Brad Templeton. TRS-80 program by Joshua Lavinsky.

Personal Software, Inc., also produces the VisiCalc™ program (the software that's revolutionizing personal

computing), CCA Data Management System, the Vitafacts series and other exciting software for the Apple, PET and TRS-80.

Now that you've read about the Personal Software programs, go see a demonstration. For the name of your nearest Personal Software dealer, call (408) 745-7841 or write to Personal Software, Inc., 592 Weddell Drive., Sunnyvale, CA 94086.



Gammon Gambler

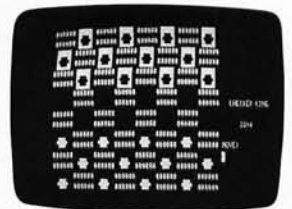

Checker King



PERSONAL SOFTWARE



STRATEGY GAMES SERIES

Listing 6: Test program coded in assembler language for the IBM 370. Writing in the native language of this very fast machine, we obtain the shortest time for finding prime numbers from 5 to 10,000.

	LA	R2,5	STARTING VALUE FOR TEST
	SR	R10,R10	COUNT OF PRIME NUMBERS
	LA	R6,2	LOOP INCREMENT - INNER LOOP
	LR	R8,R6	LOOP INCREMENT - OUTER LOOP
	LH	R9,=H'10000'	UPPER LIMIT FOR OUTER LOOP
OLOOP	LA	R3,3	STARTING VALUE FOR TESTING NUMBER
	LR	R7,R2	COMPUTE INNER LOOP LIMIT
	SRL	R7,1	DIVIDE BY TWO
ILOOP	SR	R4,R4	ZERO EVEN DIVIDEND PAIR
	LR	R5,R2	LOAD ODD DIVIDEND VALUE
	DR	R4,R3	R3 IS DIVISOR
	LTR	R4,R4	CHECK REMAINDER
	BZ	NEXTO	ZERO IS NOT PRIME
	BXLE	R3,R6,ILOOP	INNER LOOP
	CVD	R2,WORK	CONVERT PRIME NUMBER TO DECIMAL
	UNPK	DATA(7),WORK + 4(4)	MAKE EBCDIC
	OI	DATA + 6,X'F0'	SET SIGN CORRECT
	PUT	SYSPRINT, DATA	OUTPUT PRIME NUMBER
	LA	R10,1(R10)	INCREMENT PRIME NUMBER COUNT
NEXTO	BXLE	R2,R8,OLOOP	OUTER LOOP
	CVD	R10,WORK	CONVERT COUNT TO DECIMAL
	UNPK	DATA(7),WORK + 4(4)	AND TO EBCDIC
	OI	DATA + 6,X'F0'	SET SIGN CORRECT
	PUT	SYSPRINT, DATA	OUTPUT COUNT

Test Problem and the Large System

At the completion of the TRS-80 testing phase, I coded two versions of the test problem to be run on the IBM 370-148. Listings 5 and 6 show PL/I language and 370 assembler language codings of the prime-number generator. The execution times showed little difference. The PL/I version (compiled, rather than interpreted) ran in 1 minute and 19 seconds of processor time. The test run in assembler language used 56 seconds of processor time.

The best comparison between the two machine's capabilities is arranged by counting the number of instructions needed to perform division; twelve for the TRS-80 (ten of which are looped sixteen times) and one for the 370. Performance difference is also indicated by the average execution time of 1108 μ s for the Z80 division subroutine versus 30.7 μ s for the DR (divide register into register) instruction of the 370-148. This is a time ratio of 36 to 1. If you compare a less complex function, such as 16-bit storage-to-register load, the TRS-80 performs closer to the 370 capability; the Z80 LD HL,(n) instruction takes 16 cycles or 9.008 μ s, and the 370 load halfword takes 1.958 μ s. The 16-bit load operation compares as a 4.6 performance ratio. Thus, it is shown that a single instruction comparison does not always represent the required work performance ratio.

Conclusions

The test program I chose can be run with the same results on both the TRS-80 and the IBM 370-148. There is a difference in system throughput and cost. An analysis of the TRS-80 performance indicates that the advertised improvements of Level I keyword abbreviations and Level II BASIC are present. The analysis of the TRS-80 BASIC versus Z80 assembler language shows a significant improvement in assembler language, if you care to code the program that way or if you need the speed. I now have an answer for my friends at work when they ask about the speed differences between my personal computer system and the personal IBM 370-148. ■

TURN-ON!

Now have full computer control of up to 256 lights, appliances and even wall switches **without special wiring**. The SciTronics REMOTE CONTROLLER permits direct control of the inexpensive BSR remote line-carrier switches sold by Sears, Radio Shack and many others.

HOW IT WORKS: Writing 3 control words to the controller board sends one of 6 instructions over the a-c line to the desired switch. The instructions include any remote on, off, all off, any light bright, dim, or all on. Reading the board tells if busy.

FEATURES:

- ★ FULL S-100 COMPATIBILITY—all lines fully buffered, board address dip switch selectable to span 65K.
- ★ FULL TRS-80-1 COMPATIBILITY—board housed in attractive woodgrained case with power supply and connector cable allows direct connection to TRS-80-1 expansion port.
- ★ COMPATIBLE WITH OTHER SYSTEMS—combination of on-board select switches and complete connector wiring information allows ease of use with Apple II, PET, KIM, SYM, HEATH H8, plus others.
- ★ SYSTEM SELECT SWITCHES—choose active high or low inputs, addressed or I/O drive, parallel or serial entry, non S-100 inputs like VMA, clocking on any transition.
- ★ SIMPLE TO USE—sample software included for all systems listed, all IC's socketed.

APPLICATIONS:

- ★ Make your entire home, business or apartment "computer controlled"
- ★ Save energy by controlling lights and appliances
- ★ Control lights and alarms for security systems



REMOTE CONTROLLER BOARD \$159.

ENCASED SELF POWERED CONTROLLER FOR TRS-80-1 \$184.

remote switches not included

Send check or money order to:

SciTronics Inc.
523 S. Clewell St., P.O. Box 5344
Bethlehem, PA 18015
(215) 868-7220

Please list system with which you plan to use controller. Master Charge and Visa accepted. PA residents add sales tax.

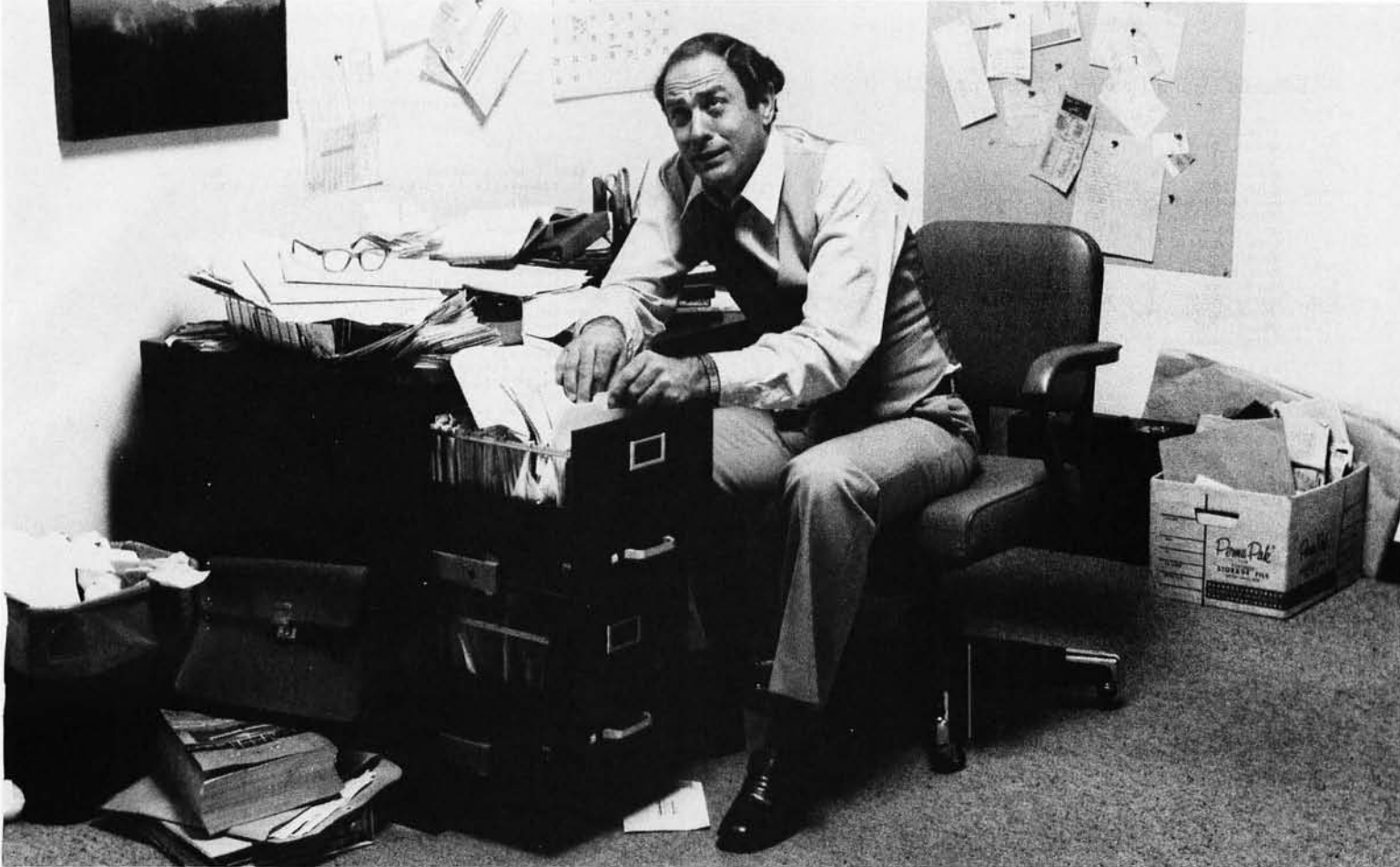

Record keeping problems? Our CCA Data Management System solves them easily.

Having information at your fingertips can make your job a whole lot easier. And that's what the CCA Data Management System is all about.

With this Personal Software™ package and an Apple II™ or TRS-80™ disk system, it will be far easier to keep inventories, customer lists, accounts receivable and payable records, patient histories and many more items.

In fact, you can use the CCA DMS for all of your data management needs, rather than buying (expensive) or writing (time consuming) separate programs for each application. That's because DMS lets you create your own filing systems, adapting itself to the types of records you keep. You specify the number and names of each data field—without any programming.

With DMS keeping all of your records, you only have to learn how to use one system. That's easier, too. It's menu driven, with plenty of prompts to help you create files and add, update, scan, inspect, delete, sort, condense and print data. Our comprehensive 130-page step-by-step instruction manual even provides complete "how to" inventory and mailing list applications so you can start processing immediately.

DMS is a very powerful system, with more file and record storage capacity than other data base programs on the market.

*Apple is a trademark of Apple Computer, Inc.; TRS-80 is a trademark of the Radio Shack Div. of Tandy Corp.

And it also gives you greater data handling flexibility. To customize DMS, write add-on BASIC programs that read or write DMS files and perform any kind of processing you want.

You can sort and print your data in nearly any form of report and mailing label you want. Sort data by up to 10 fields for zip code, balance due, geographic location or whatever. And print reports with subtotals and totals automatically calculated.

The CCA Data Management System, written by Creative Computer Applications, has two years of field testing on other microcomputers. Now Personal Software makes DMS available on the TRS-80 Level II and Apple II and II Plus 48k disk systems. And at under \$100, DMS is also easy to afford.

One demonstration will convince you how easy computerized record keeping is. Ask your Personal Software dealer to show you. To locate your nearest dealer, contact Personal Software, Inc., (408) 745-7841, 592 Weddell Dr., Sunnyvale, CA 94086.



**PERSONAL
SOFTWARE**

```

x:n      : INTEGER;
sigma    : INTEGER;
which_rins : (second,third);

a,b,c    : absolute_time;
rins_time : absolute_time;
second_contact_rins : absolute_time;
third_contact_rins : absolute_time;
tot_time : absolute_time;
time_totality : absolute_time;
margin_time : absolute_time;
current_time : absolute_time;
half_time : absolute_time;
quarter_time : absolute_time;
slack_in_totality : absolute_time;
dummy : absolute_time;
total_duration : absolute_time;

maximum : exposures;
total_eclipse : exposures;
rins_frames : exposures;
current_shot : exposures;

ten_shot_groupings : PACKED ARRAY[0..9] OF an_exposure_detail;
transient_shots : PACKED ARRAY[0..1] OF an_exposure_detail;

PROCEDURE new_page;
VAR
  stuff : STRING[24];
  clear_screen : CHAR;
BEGIN
  stuff := '
  clear_screen := CHR(24);
  WRITELN(clear_screen,stuff);
  WRITELN(' ');
  WRITELN(' ');
  WRITELN(s);
END (new_page);

PROCEDURE set_parameter(VAR time : absolute_time);
VAR
  a_strings : STRING[128];
  i : INTEGER;
  period : BOOLEAN;
  decimal_count : INTEGER;
  factor, result : INTEGER;

PROCEDURE add_a_disit(position : INTEGER);
VAR
  disit : INTEGER;
BEGIN
  disit := (ORD(a_strings[position])-ORD('0'));
  IF period THEN
    BEGIN
      decimal_count := decimal_count + 1;
      IF decimal_count < 4 THEN
        BEGIN

```

```

time.thousandths := time.thousandths
+ ((1000 * disit) DIV factor);
factor := 10 * factor;
END
END
ELSE (before period)
time.units := (time.units * factor) + disit;
END;

BEGIN (set_parameter)
PAGE(OUTPUT);
time.units := 0;
time.thousandths := 0;
WHILE ((time.units=0) AND (time.thousandths=0)) DO
BEGIN
  factor := 10;
  decimal_count := 0;
  period := FALSE;
  WRITELN(s);
  READLN(a_strings);
  FOR i := 1 TO LENGTH(a_strings) DO
    BEGIN
      CASE a_strings[i] OF
        '0','1','2','3','4','5','6','7','8','9':
          add_a_disit(i);
        ',':
          period := TRUE;
      END
    END
  END (WHILE)
END (set_parameter);

PROCEDURE initialize;
VAR
  i : INTEGER;
BEGIN (initialize)
  s := '';
  current_time.units := 0;
  current_time.thousandths := 0;
  current_shot := 0;
  ten_shot_groupings[0].duration := 1;
  ten_shot_groupings[1].duration := 4;
  ten_shot_groupings[2].duration := 16;
  ten_shot_groupings[3].duration := 64;
  ten_shot_groupings[4].duration := 128;
  ten_shot_groupings[5].duration := 256;
  ten_shot_groupings[6].duration := 512;
  ten_shot_groupings[7].duration := 1024;
  ten_shot_groupings[8].duration := 2048;
  ten_shot_groupings[9].duration := 4096;
  FOR i := 0 TO 9 DO
    ten_shot_groupings[i].wait_after := overhead_duration;

  transient_shots[0].duration := 4;
  transient_shots[1].duration := 32;
  FOR i := 0 TO 1 DO

```

Listing 1 continued on page 98

SPECIALIZING IN QUALITY MICROCOMPUTER HARDWARE

INDUSTRIAL • EDUCATIONAL • SMALL BUSINESS • PERSONAL

BUILDING BLOCKS FOR MICROCOMPUTER SYSTEMS, CONTROL & TEST EQUIPMENT

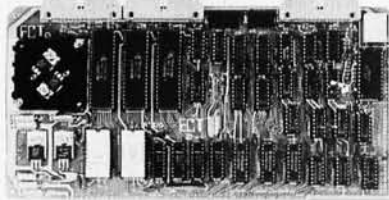

R² I/O
 2K ROM
 2K RAM
 3 Serial Ports
 1 Parallel Port
WIRED: \$295.00

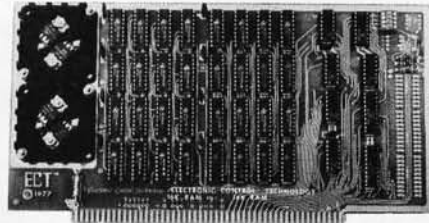

16 K RAM
 FULLY STATIC
 MEMORY
KIT: \$279.00
WIRED: \$310.00

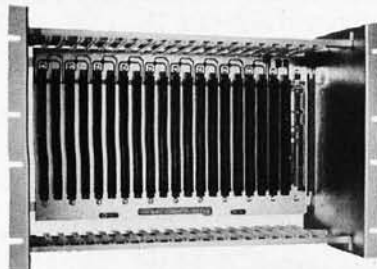

ECT-100-F
 RACKMOUNT
 CARD CAGES
KIT: \$200.00
WIRED: \$250.00



TT-10
 TABLE TOP
 MAINFRAMES
KIT: \$340.00
WIRED: \$395.00

POWER SUPPLIES, CPU's, MEMORY, OEM VARIATIONS

763 RAMSEY AVE.
 HILLSIDE, N.J. 07205

ELECTRONIC CONTROL TECHNOLOGY (201) 686-8080

Operating Power!

with
I/OS™ Version 3.0

8080/Z80 OPERATING SYSTEM

The former TSA/OS has been significantly upgraded and improved...

- New Spooler
- Hard disk support
- Big files supported (over 200,000,000 bytes)
- New system support functions and utilities
- Improved versions of standard utilities
- New improved manuals

\$150 gets it all I/OS, spooler, utilities, manuals!
(plus dealer configuration charges)

Now also available
for the Radio Shack
TRS 80 MODEL II!

A BIG SYSTEM OS FOR YOUR MICRO!

- True 'sysgen' for an optimized system for any hardware
- Support for most popular terminals, devices and systems plus user driver interface
- CP/M* — CDOS* — SDOS* compatible
- Supports systems with multiple disk types (two or more drivers)

*TM Digital Research, Cromemco, SD Systems

SPECIAL OFFER

for
TRS 80 MODEL II — I/OS
PLUS
the Wp Daisy™ Word Processor...

\$550
total price!

★★★ **NEXT MONTH** ★★★

I/Pascal™ compiler
I/SAL™ structured assembler
...more to follow!



Software for I/OS — TSA/OS — CDOS — SDOS —
other 8080/Z80 OS*M operating systems

Circle 61 on inquiry card.

Contact your dealer or...

InfoSoft
SYSTEMS INCORPORATED
25 SYLVAN ROAD SOUTH
WESTPORT, CONN. 06880
(203) 226-8937

WHAT IF?

WHAT IF

interest rates climb another two points?

WHAT IF

we retire long-term debts earlier?

WHAT IF

we could increase our market share by 7% by hiring three more salesmen?

WHAT IF

a 30% increase in advertising could produce a 5% increase in sales?

WHAT IF

passenger seat sales increase 1/2% per month for the next 24 months?

WHAT IF

gasoline price increases drive delivery costs up 10%?

WHAT IF

you had a tool to evaluate your "what ifs"?

minimodel

is just such a tool. It can answer your "what ifs" in minutes, and you don't need to know a thing about programming to use it.

minimodel

allows the business manager to build a model of any corporate activities. You provide the assumptions and MINIMODEL responds with a projection of how those assumptions will affect your sales volume, revenues, costs, profitability, cash flow or any factors you specify.

minimodel

is completely flexible to permit virtually any combination of assumptions and event sequences. Model size is limited only by disc capacity.

minimodel

is designed by professionals for the business manager who wants to know "what if?"

minimodel

is currently available for Horizon S/D/Q, 32K and for TRS-80, 32K. (Requires CP/M and C BASIC) Other versions are in production—please enquire.

minimodel™

FINANCIAL PLANNING ASSOCIATES
55 University Avenue, Suite 600
Toronto, Ontario M5J 2H7

For Horizon Single Double Quad. Density
 TRS-80 Model I.

Please send Minimodel \$495 (U.S. Funds) _____
 Manual only \$50 (U.S. Funds) _____
 Send C.O.D. (\$10 extra) _____
 Full payment enclosed \$ _____

Charge my Visa Mastercharge Acct. # _____

Expiry date _____ Signature _____

Name _____

Address _____

City _____ State _____ Zip _____

I have a _____

Please advise when Minimodel will be available.

Listing 1 continued:

```
transient_shots[i].wait_after := overhead_duration;
s := 'Preliminary data initialization';
new_page;
WRITELN
('totality' is defined as time from second to third contacts');
s := 'Enter number of exposures';
set_parameter(dummy);
maximum := dummy.units;
s := 'Enter number of exposures during totality';
REPEAT
BEGIN
set_parameter(dummy);
total_eclipse := dummy.units
END
UNTIL
(total_eclipse > 0)
AND
(total_eclipse < maximum);
s := 'Enter time of totality in "seconds.thousandths"';
set_parameter(time_totality);
s := 'Enter slack time margin (in seconds)';
set_parameter(slack_in_totality);
crash_ahead := TRUE
END (initialize);

PROCEDURE error_abort;
BEGIN
maximum := 250;
total_eclipse := 200;
rins_frames := 25;
WRITELN('Unrecoverable error in data');
crash_ahead := FALSE
END;

PROCEDURE subtract_time(a,b : absolute_time; VAR c : absolute_time);
BEGIN
c.thousandths := a.thousandths - b.thousandths;
sidma := 0;
IF c.thousandths < 0 THEN
BEGIN
c.thousandths := c.thousandths + 1000;
sidma := -1
END;
c.units := a.units \ - b.units + sidma
END;

PROCEDURE divide_time(
VAR a : absolute_time;
b : absolute_time;
n : INTEGER
);
(a <-- b DIV n )
VAR
p : INTEGER(16);
BEGIN
a.thousandths := 0;
a.units := 0;
a := b.units;
a := a * 1000;
a := a + b.thousandths;
a := a DIV n;
p := a DIV 1000;
IF p < 32768 THEN
a.units := TRUNC(p);
p := a - (1000 * p);
IF p < 32768 THEN
a.thousandths := TRUNC(p)
END;

PROCEDURE add_time(a,b : absolute_time; VAR c : absolute_time);
BEGIN
sidma := a.thousandths + b.thousandths;
c.thousandths := sidma MOD 1000;
c.units := a.units + b.units + (sidma DIV 1000)
END;

PROCEDURE print_time(a : absolute_time);
VAR
z1000,z100 : STRING(13);
BEGIN
IF a.thousandths < 100 THEN z1000 := '0' ELSE z1000 := '';
IF a.thousandths < 10 THEN z100 := '0' ELSE z100 := '';
WRITELN(s,a.units,'.',z1000,z100,a.thousandths)
END;

PROCEDURE normalize_timings;
VAR
i : INTEGER;

PROCEDURE sum_up_rins(rins : INTEGER; VAR rins_total : absolute_time);
VAR
index,i : INTEGER;
this_rins : absolute_time;
BEGIN
rins_total.units := 0;
rins_total.thousandths := 0;
FOR i := 1 TO rins_frames DO
BEGIN
this_rins.units := 0;
this_rins.thousandths := transient_shots[rins].wait_after;
add_time(this_rins,rins_total,rins_total);
this_rins.thousandths := transient_shots[rins].duration;
add_time(this_rins,rins_total,rins_total)
END
END;

PROCEDURE sum_up_eclipse(VAR eclipse_total : absolute_time);
VAR
this_shot : absolute_time;
index,i,j : INTEGER;
BEGIN
eclipse_total.units := 0;
eclipse_total.thousandths := 0;
FOR i := 1 TO total_eclipse DO
BEGIN
```

Listing 1 continued on page 100



THE DATA BASE SPECIALIST

HDBS - HIERARCHICAL DATA BASE MANAGEMENT SYSTEM MDBS - OUR FULL NETWORK DATA BASE MANAGEMENT SYSTEM

HDBS FEATURES	ADDITIONAL FEATURES IN MDBS	
<ul style="list-style-type: none"> • HIERARCHICAL DATA STRUCTURES • FIXED LENGTH RECORDS • READ/WRITE PROTECTION AT FILE LEVEL • ONE-TO-MANY SET RELATIONSHIPS ALLOWED 	<ul style="list-style-type: none"> • HIERARCHICAL AND FULL NETWORK DATA STRUCTURES (CODASYL ORIENTED) • FIXED AND VARIABLE LENGTH RECORDS • MULTIPLE LEVELS OF READ/WRITE PROTECTION AT ITEM, RECORD, SET AND FILE LEVELS 	<ul style="list-style-type: none"> • EXPLICIT REPRESENTATION OF ONE-TO-ONE, ONE-TO-MANY, MANY-TO-ONE AND MANY-TO-MANY SETS • RECORD TYPES MAY OWN OTHER OCCURRENCES OF THE SAME RECORD TYPE • A SINGLE SET MAY HAVE MULTIPLE OWNER AND MEMBER RECORD TYPES

FEATURES COMMON TO HDBS and MDBS

STRAIGHT FORWARD USE OF ISAM-LIKE STRUCTURES
 SORTED, FIFO, LIFO, NEXT AND PRIOR SET ORDERING PROVIDED
 COMMANDS TO ADD, DELETE, UPDATE, SEARCH AND TRAVERSE THE DATA BASE
 NAMES OF DATA ITEMS, RECORDS, SETS AND FILES ARE WHOLLY USER DEFINABLE
 RECORDS CAN BE MAINTAINED IN A NUMBER OF SORTED ORDERS
 ROUTINES ARE CALLABLE FROM BASIC, PASCAL, FORTRAN, COBOL OR MACHINE LANGUAGE
 WRITTEN IN MACHINE LANGUAGE FOR MAXIMAL EXECUTION EFFICIENCY AND MINIMAL MEMORY USAGE
 SUPPORTS DATA BASE SPREAD OVER SEVERAL DISK DRIVES (MAX. 8) DISKS MAY BE MINI OR FULL SIZED FLOPPIES OR HARD DISKS

— Also —

UP TO 254 RECORD-TYPES MAY BE DEFINED IN THE DATA BASE
 EACH RECORD-TYPE MAY CONTAIN UP TO 255 ITEM-TYPES
 EACH ITEM-TYPE MAY BE UP TO 9,999 BYTES IN LENGTH

REQUIREMENTS

- Z-80 APPROXIMATELY 16K MEMORY -
- 8080 APPROXIMATELY 20K MEMORY -
- IN ADDITION TO THE OPERATING SYSTEM, HOST LANGUAGE, USER'S PROGRAM AND SOME BUFFER AREA
- 6502 APPROXIMATELY 26K MEMORY

NEW DYNAMIC RESTRUCTURING SYSTEM

MDBS-DRS FEATURES

ALLOWS ITEM, RECORD AND/OR SET TYPES TO BE ADDED TO OR DELETED FROM AN EXISTING MDBS DATA BASE. THIS ALLOWS THE USER TO RE-DESIGN A DATA BASE AFTER IT IS ALREADY ON-LINE.

THIS FEATURE CAN ONLY BE ADDED TO THE MDBS SYSTEM.

HDBS and MDBS PACKAGES INCLUDE

DDL DATA DEFINITION LANGUAGE ANALYZER/EDITOR. The user specifies data structures to be used in a Concise Data Definition Language (DDL). The Data Definition Language Analyzer/Editor allows the user to interactively create and edit DDL Specifications and to initialize the data base for use based on these specifications.

260 PAGE USERS MANUAL with extensive documentation of the Data Base Management System.

DMS DATA MANAGEMENT ROUTINES. These are the routines callable from the host language (BASIC, PASCAL, etc.) which perform the data base operations of finding, adding, and deleting records; fetching and storing data items; and traversing the (possibly complex) data structure.

SAMPLE APPLICATION PROGRAM AND DDL FILES

RELOCATOR TO RE-ORG ALL ROUTINES

SYSTEM SPECIFIC MANUAL to show how to bring up our software on your computer

HDBS - Z80 VERSION	\$250
8080 and 6502 VERSIONS	\$325
MANUAL ONLY	\$ 35
UPGRADE TO MDBS	\$550
MDBS - Z80 Version	\$750
8080 and 6502 VERSIONS	\$825
MANUAL ONLY	\$ 35
MACHINE LANGUAGE CALLABLE FORMS ADD	\$ 75
MDBS - DRS	\$100
MANUAL ONLY	\$ 5



FOR FREE PRIMER CONTACT MDBS.

ADD \$2.50 (\$5.00 IF FOREIGN) TO NON-CASH ORDERS FOR HANDLING AND SHIPPING. INDIANA RESIDENTS ADD 4%.

RUNS UNDER

- CP/M* WITH MICROSOFT BASIC, COBOL AND FORTRAN
- NORTHSTAR DOS WITH NORTHSTAR BASIC
- TRSDOS* AND DISK BASIC
- NEWDOS AND DISK BASIC
- APPLE* DOS AND APPLE* SOFT BASIC
- MACHINE LANGUAGE CALLABLE FORMS
- OTHER FORMS IN DEVELOPMENT

MICRO DATA BASE SYSTEMS, INC

P.O. BOX 248 LAFAYETTE, IN 47902
(317) 742-7388

CP/M is a registered trademark of Digital Research Corp.
 TRS-80 is a registered trademark of Radio Shack/Tandy Corp.
 Apple is a registered trademark of Apple Computers, Inc.



compas
microsystems

There is nothing like a

DAIM

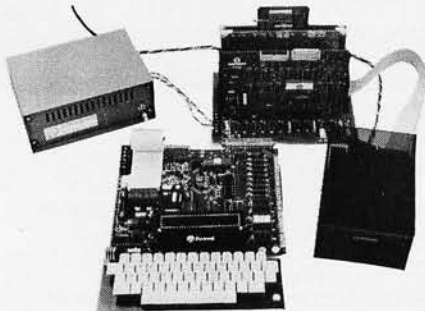

A complete disk system for the Rockwell Aim 65. Uses the Rockwell Expansion Motherboard. Base price of \$850 (U.S.) includes controller with software in Eprom, disk power supply and one packaged Shugart SA400 Drive.

224 SE 16th St.
P.O. BOX 687

AMES, IA 50010
(515) 232-8187

6502

ASSEMBLER

in standard microsoft basic for your cp/m system!

You can now assemble a 6502 program on your 8080/280 based system under cp/m, using all the powerful software facilities: files, editor, etc. The assembler will even give you a hex file ready for use on your 6502 system. It is formatted for KIM/SYM/AIM cassettes. Industry standard 6502 mnemonics and commands. Basic version 5.0. 8" cp/m format diskette \$65.00

AVAILABLE AT COMPUTER STORES EVERYWHERE

TO ORDER:
By Phone: (415) 848-8233, Visa, MC, AmEx
By Mail: Indicate quantity desired. Pre-payment required
Shipping: Add \$1.50 per order (UPS) or 75¢ (4th Class—allow 4 weeks delivery)
Tax: In Ca. please add tax

**Dept. B3
2344 Sixth St.
Berkeley, CA
94710**

Listing 1 continued:

```

this_shot.units := 0;
index := (i-1) MOD 10;
this_shot.thousandths := ten_shot_groups[index].wait_after;
add_time(this_shot,eclipse_total,eclipse_total);
this_shot.thousandths := ten_shot_groups[index].duration;
add_time(this_shot,eclipse_total,eclipse_total)
END
END;

PROCEDURE preliminary_allocation;
BEGIN
  s := 'Allocation of Eclipse Times...';
  new_page;
  s := '          Total time for eclipse = ' ;
  print_time(time_totality);

  WRITELN('-----');
  which_rins := second;
  sum_up_rins(ORD(which_rins),second_contact_rins);

  s := 'Time required for second contact transient = ' ;
  print_time(second_contact_rins);

  which_rins := third;
  sum_up_rins(ORD(which_rins),third_contact_rins);

  s := 'Time required for third contact transient = ' ;
  print_time(third_contact_rins);

  add_time(second_contact_rins,third_contact_rins,rins_time);
  s := 'Total time devoted to diamond rins sequences= ' ;
  print_time(rins_time);
  divide_time(quarter_time,second_contact_rins,2);
  s := ' Anticipation time for first diamond rins = ' ;
  print_time(quarter_time);

  WRITELN('-----');
  sum_up_eclipse(tot_time);
  s := '          Time devoted to totality = ' ;
  print_time(tot_time);
  s := '          Slack time margin at end of totality = ' ;
  print_time(slack_in_totality);

  divide_time(half_time,rins_time,2);
  s := 'Extra slack due to diamond rins overlaps = ' ;
  print_time(half_time);

  add_time(tot_time,slack_in_totality,total_duration);
  add_time(total_duration,half_time,total_duration);
  s := 'Total time committed before marsin alloc. = ' ;
  print_time(total_duration);

  WRITELN('-----');
  subtract_time(time_totality,total_duration,marsin_time);
  s := '          Difference is time margin for allocation = ' ;
  print_time(margin_time)
END (preliminary_allocation);

PROCEDURE marsin_dispersal;
VAR
  marsin_per_frame : absolute_time;
  i : INTEGER;
BEGIN
  divide_time(marsin_per_frame,marsin_time,total_eclipse);
  FOR i := 0 TO 9 DO
    ten_shot_groups[i].wait_after :=
      ten_shot_groups[i].wait_after +
      (1000 * marsin_per_frame.units) +
      marsin_per_frame.thousandths;
  s := '          Marsin per totality frame = ' ;
  print_time(marsin_per_frame)
END (marsin_dispersal);

PROCEDURE final_allocation;
BEGIN
  sum_up_eclipse(tot_time);
  s := '          Adjusted time devoted to total phase = ' ;
  print_time(tot_time);

  add_time(tot_time,slack_in_totality,total_duration);
  add_time(total_duration,half_time,total_duration);
  s := '          Adjusted total time committed = ' ;
  print_time(total_duration);

  WRITELN('-----');
  subtract_time(time_totality,total_duration,marsin_time);
  s := '          Marsin time after allocation to totality = ' ;
  print_time(margin_time)
END (final_allocation);

PROCEDURE alloc_exposures;
BEGIN
  rins_frames :=
    (maximum - total_eclipse) DIV 2;
  IF rins_frames < 2 THEN error_abort;
  sigma := maximum - (total_eclipse + (2 * rins_frames));
  total_eclipse := total_eclipse + sigma;
  WRITELN('');
  WRITELN('Exposures map:');
  WRITELN('  First diamond rins = ',rins_frames);
  WRITELN('  Totality = ',total_eclipse);
  WRITELN('  Second diamond rins = ',rins_frames);
  WRITELN('');
  WRITELN('          TOTAL = ',maximum);
  WRITELN('');
  WRITELN('');
  WRITELN('Press return to continue');
  READLN(s);
END (alloc_exposures);

BEGIN (normalize_limins)
  alloc_exposures;
  preliminary_allocation;

```

Listing 1 continued on page 102

CP/M* VERSION 2 FOR TRS-80* MODEL II NOW AVAILABLE

Prices reflect distribution on 8" single density diskettes. If a format is requested which requires additional diskettes, a surcharge of \$3. per additional diskette will be added.

All Lifeboat programs require CP/M, unless otherwise stated.

- DIGITAL RESEARCH**
- CP/M FLOPPY DISKETTE OPERATING SYSTEM - Packages based on diskette complete with 8080 assembler, text editor, 8080 debugger and various utilities plus full documentation. CP/M available configured for most popular computer/disk systems including North Star Single, Double or QDOS density, Altair 8" disks, Helios II, Exidy Sorcerer, Vector MZ, Heath H17 or H89, TRS-80, ICOM 3712 and ICOM Micro Disk plus many other configurations available off the shelf. **\$145/\$25**
 - CP/M version 2 (not all formats available immediately) **\$170/\$25**
 - MP/M* **\$300/\$50**

- Lower prices!*
- EIDOS SYSTEMS**
- KISS - Keyed Index Sequential Search. Offers complete Multi-Keyed Index Sequential and Direct Access file management. Includes built-in utility functions for 16 or 32 bit arithmetic, string/integer conversion and string compare. Delivered as a relocatable module in Microsoft format for use with FORTRAN-80 or COBOL-80. **\$335/\$23**
 - KBASIC - Microsoft Disk Extended BASIC with all KISS facilities, integrated by implementation of nine additional commands and language extensions. Includes KISS REL as described above, and a sample mail list program. **\$585/\$45**
 - To licensed users of Microsoft BASIC-80 (MBASIC) **\$435/\$45**

- ANALYST - Customized data entry and reporting system. User specifies up to 75 data items per record. Interactive data entry, retrieval, and update facility makes information management easy. Sophisticated report generator produces customized reports using selected records with multiple level break-points for summarization. Requires CBASIC-2. **\$250/\$15**
- LETTERIGHT - Program to create, edit and type letters or other documents. Has facilities to enter, display, delete and edit text with good video screen presentation. Designed to integrate with NAD for form letter mailings. Requires CBASIC-2. **\$200/\$25**
- NAD Name and Address selection system - Interactive mail list creation and maintenance program with output as full reports with reference data or restricted information for mail labels. Transfer system for extraction and transfer of selected records to create new files. Requires CBASIC-2. **\$100/\$20**
- QSORT - Fast sort/merge program for files with fixed record length, variable field length information. Up to five ascending or descending keys. Full back-up of input files created. **\$100/\$20**

- ZOT - Z80 Monitor Debugger to break and examine registers with standard Zilog/Mostek mnemonic disassembles displays. \$35 when ordered with Z80 Development Package. **\$50/\$10**
- DISTEL - Disk based disassembler to Intel 8080 or TDX. Includes disassembler listing and cross reference files. Intel or TDX/XTian pseudo ops optional. Runs on 8080. **\$65/\$10**
- DIS/LOG - As DISTEL to Zilog/Mostek mnemonic files. Runs on TRS-80 only. **\$65/\$10**
- XASM-68 - Non-macro cross-assembler with nested conditionals and full range of pseudo operations. Assembles from standard Motorola MC6800 mnemonics to Intel hex. **\$200/\$25**
- XASM-65 - As XASM-68 for MOS Technology MCS-6500 series mnemonics. **\$200/\$25**
- TEXTWRITER III - Text formatter to justify and paginate letters and other documents. Special features include insertion of text during execution from other disk files or console, permitting routine documents to be created from linked fragments on other files. Has facilities for sorted index, table of contents and footnote insertions. Ideal for contracts, manuals, etc. Now compatible with Electric Pencil. **\$125/\$20**
- POSTMASTER - A comprehensive package for mail list maintenance that is completely menu driven. Features include keyed record extraction and label production. A form letter program is included which provides neat letters on single sheet or continuous forms. Compatible with NAD files. Requires CBASIC-2. **\$150/\$15**
- WHAT5IT? - Interactive data-base system using algebraic notation to retrieve information by subject. Hashing and random access used for fast response. Requires CBASIC-2. **\$125/\$25**
- XYBASIC Interactive Process Control BASIC - Full disk BASIC features plus unique commands to handle bytes, totals and set bits. Available in Integer, Extended and ROMable versions. Integer Disk or Integer ROMable. **\$295/\$25**
- Extended Disk or Extended ROMable. **\$395/\$25**

- Lower prices!*
- MAC - 8080 Macro Assembler. Full Intel macro definitions. Pseudo ops include NPC, IRP, REPT, TITLE, PAGE, and MACLIB. Z80 library included. Produces Intel absolute hex output plus symbols file for use by SID (see below). **\$85/\$15**
 - SID - 8080 symbolic debugger. Full trace, pass control and break-point program testing system with backtrace and histogram utilities. When used with MAC, provides full symbolic display of memory labels and equivalent values. **\$70/\$15**
 - Z80 - As above for Z80. Requires Z80 CPU **\$95/\$25**
 - TEX - Text formatter to create paginated, page numbered and justified copy from source text files. Direct-to-disk or print to disk. **\$70/\$15**
 - DESPOOL - Program to permit simultaneous printing of data from disk while user executes another program from the console. **\$45/\$5**

- all micropro prices are discounted!*
- MICROPRO**
- SUPER-SORT I - Sort, merge, extract utility as absolute executable program or linkable module in Microsoft format. Sorts fixed or variable records with data in binary, BCD, packed Decimal, EBCDIC, ASCII, floating, fixed point, exponential, field justified, etc. Even variable number of fields per record! **\$225/\$25**
 - SUPER-SORT II - Above available as absolute program only. **\$175/\$25**
 - SUPER-SORT III - As II without SELECT/EXCLUDE option. **\$125/\$25**
 - WORD-STAR - Menu driven visual word processing with full word and paragraph editing. Text formatting performed on screen. Facilities for creating and page number, justify, center and underscore. User can print one document while simultaneously editing a second. Edit facilities include search and replace, Read/Write to other text files, block move, etc. Requires CRT terminal with addressable cursor positioning. **\$445/\$40**
 - WORD-STAR/MAIL-MERGE - As above with option for production mailing of personalized documents with mail list from Datasat or NAD. **\$575/\$25**
 - WORD-STAR Customization Notes - For sophisticated users who do not have one of the many standard terminal or printer configurations in the distribution version of WORD-STAR. **N/A/\$100**
 - WORD-MASTER Text Editor - In one mode has superpower of CP/M's command line editing, search and replace, and replacing, forwards and backwards in file in video mode, provides full screen editor for users with serial addressable cursor terminal. **\$125/\$25**
 - DATASAT - Professional forms control entry and display system for key-to-disk data capture. Menu driven with built-in learning aids. Input field verification by length, mask, attribute (i.e. uppercase, lowercase, numeric, auto skip, etc.) Built-in arithmetic capabilities using keypad data, constants and derived values. Visual feedback for ease of forms design. Files compatible with all CP/M-MP/M supported languages. Requires 32K CP/M. **\$350/\$35**

GRAHAM-DORIAN SOFTWARE SYSTEMS

- GENERAL LEDGER - An on-line system; no batching is required. Entries to other GRAHAM-DORIAN accounting packages are automatically posted. User establishes customized Proforma transactions and registers, record of journal entries, trial balances and monthly closings. Keeps 14 month history and provides comparison of current year with previous year. Requires CBASIC-2. Supplied in source. **\$995/\$35**
- ACCOUNTS PAYABLE - Maintains vendor list and check register. Performs cash flow analysis. Flexible - writes checks to specific vendor for certain invoices or can make partial payments. Automatically posts to other GRAHAM-DORIAN general ledger or stand alone system. Requires CBASIC-2. Supplied in source. **\$995/\$35**
- ACCOUNTS RECEIVABLE - Creates trial balance reports, prepares statements, accounts and records receivable. Provides customer tracking and analyzing customer payment activity. Receipts can be posted to different ledger accounts. Entries automatically update GRAHAM-DORIAN general ledger or stand alone system. Requires CBASIC-2. Supplied in source. **\$995/\$35**
- PAYROLL SYSTEM - Maintains employee master file. Computes payroll withholding for FICA, Federal and State taxes. Prints payroll register, checks, quarterly reports and W-2 forms. Can generate ad hoc reports and employee form letters with mail labels. Requires CBASIC-2. Supplied in source. **\$590/\$35**
- INVENTORY SYSTEM - Captures stock levels, costs, sources, sales, age, turnover, markup, etc. Transaction information may be entered for reporting by item, type of sale, date of sale, etc. Reports available both for accounting and decision making. Requires CBASIC-2. Supplied in source. **\$590/\$35**
- JOB COSTING - Designed for general contractors. To be used interactively with other GRAHAM-DORIAN accounting packages for tracking and analyzing expenses. User establishes customized cost categories and job phases. Permits comparison of actual versus estimated costs. Automatically updates GRAHAM-DORIAN general ledger or stand alone system. Requires CBASIC-2. Supplied in source. **\$995/\$35**
- APARTMENT MANAGEMENT SYSTEM - Financial management system for receipts and security deposits of apartment projects. Captures data on vacancies, reversals and other financial analysis. Daily report shows late rents, vacancy notices, vacancies, income lost through vacancies, etc. Requires CBASIC-2. Supplied in source. **\$590/\$35**
- CASH REGISTER - Maintains files on daily sales. Files by date and by item. Tracks and itemizes sales over-runs, refunds, payouts and total net deposits. Requires CBASIC-2. Supplied in source. **\$590/\$35**

- CPM374X - Has full range of functions to create or remove files. Up to 27 volume, directory structure information and edit the data set contents. Provides full file transfer facilities between 3741 volume data sets and CP/M files. **\$195/\$10**
- BASIC UTILITY DISK - Consists of: (1) CRUNCH-14 - Compacting utility to reduce the size and increase the speed of programs in Microsoft BASIC and TRS-80 BASIC. (2) DPFUN - Double precision subroutines for computing nineteen transcendental functions including square root, natural log, log base 10, sin, arc sin, hyperbolic sin, hyperbolic cos, etc. Both are included in source on diskette and documentation. **\$50/\$35**
- THE STRING BIT - FORTRAN character string handling. Routines to find, fill, pack, move, separate, concatenate and compare character strings. This package completely eliminates the problems associated with character string handling in FORTRAN. Supplied with source. **\$45/\$15**
- BSTAM - Utility to link one computer to another also equipped with BSTAS. Allows file transfers at full data speed (no compression). Includes file control check for very reliable error detection and automatic retry. For use with 8080 baud with wire, 300 baud with phone computer. Both ends need one. Standard and Versatile can talk to one another. Compatible TRSDOS version also available. **\$150/\$5**

- all Microsoft prices are discounted!*
- MICROSOFT**
- BASIC-80 - Disk Extended BASIC. ANSI compatible with long variable names, WHILE/WEND, chaining, variable length file records. **\$300/\$25**
 - BASIC COMPILER - Language compatible with BASIC-80 and 3-10 times faster execution. Produces standard Microsoft relocatable binary output. Includes Macro-80. Also linkable to FORTRAN-80 and COBOL-80 code. **\$350/\$25**
 - FORTRAN-80 - ANSI 68 (except for COMPLEX) plus many extensions. Includes relocatable object compiler, linking loader, library with manager. Also includes MACRO-80 (see below). **\$400/\$25**
 - COBOL-80 - Level 1 ANSI 74 standard COBOL plus most of Level 2. Full sequential, relative, and indexed file support with variable file names. STRING, UNSTRING, COMPUTE, VARYING/UNTIL, EXTEND, CALL, COPY, SEARCH, 3-dimensional arrays, compound and abbreviated conditions, nested IF. Powerful interactive screen-handling extensions. Includes compatible assembler, linking loader, and relocatable library manager as described under MACRO-80. **\$625/\$25**
 - MACRO-80 - 8080/Z80 Macro Assembler. Intel and Zilog mnemonics supported. Relocatable linkable output. Loader, Library Manager and Cross Reference List utilities included. **\$149/\$15**
 - XMACRO-86 - 8086 cross assembler. All Macro and utility features of MACRO-80 package. Mnemonics slightly modified to conform to ASM86. Compatibility data sheet available. **\$275/\$25**
 - EDIT-80 - Very fast random access text editor for text with or without line numbers. Global and in-line commands supported. File compare utility included. **\$89/\$15**

- CBASIC-2 Disk Extended BASIC - Non-interactive BASIC with assembly-code compiler and interpreter. Supports full file control, chaining, integer and extended precision variables, etc. **\$109/\$15**
- PASCAL/M - Compiler generates P code from extended language, implementation of standard PASCAL. Supports overlay technique through additional procedure calls and the SEGMENT procedure type. Provides convenient string handling capability with the added variable type STRING. Untyped files allow memory image I/O. Requires 56K CP/M. **\$350/\$30**
- PASCAL/T - Z80 native code PASCAL compiler. Produces optimized ROMable resident code. All interfacing to CP/M is through the support library. The package includes compiler, companion macro-assembler and source for the library. Requires 56K and Z80 CPU. Version 2 includes all of Jensen/Wirth except variant records. **\$275/\$25**
- Verapables include with variant records and expected 3/80. **\$395/\$25**
- PASCAL/MT - Subset of standard PASCAL. Generates ROMable 8080 machine code. Symbolic debugger included. Supports interrupt procedures. CP/M file IO and assembly-language interface. Real variables can be BCD, software floating point, or AMD 9511 hardware floating point. Version 3 includes SETs, Enumeration and Record data types. Manual explains BASIC to PASCAL conversion. Source for the run time package requires MAC (See under Digital Research). Requires 32K. **\$250/\$30**

STRUCTURED SYSTEMS GROUP

- GENERAL LEDGER - Interactive and flexible system providing proof and report outputs. Customization of COA created interactively. Multiple branch accounting centers. Extensive checking performed. All data entry for proof, COA correctness, etc. Journal entries may be batched prior to posting. Closing procedure automatically backs up input files. Now includes Statement of Changes in Financial Position. Requires CBASIC-2. **\$1250/\$25**
- ACCOUNTS RECEIVABLE - Open item system with output for internal aged reports and customer-oriented statement and billing purposes. On-Line Entry permits information for Customer Service and Credit departments. Interface to General Ledger provided if both systems used. Requires CBASIC-2. **\$1250/\$25**
- ACCOUNTS PAYABLE - Provides aged statements of accounts by vendor with check writing for selected invoices. Can be used alone or with General Ledger and/or with NAD. Requires CBASIC-2. **\$1250/\$25**
- PAYROLL - Flexible payroll system handles weekly, bi-weekly, semi-monthly and monthly payroll periods. Tips, bonuses, retroactive payments, advances, sick pay, vacation pay, etc. are all part of the payroll record. Prints government required periodic reports and will post to multiple SSG general ledger accounts. Requires CBASIC-2. **\$1250/\$25**
- INVENTORY CONTROL SYSTEM - Controls inventory functions of adding and deleting stock items, adding new items and deleting old items. Tracks quantity of items on hand, on order and back-ordered. Optional hard copy audit trail is available. Reports include Master Item List, Stock Activity, Stock Valuation and Re-order List. Requires CBASIC-2. **\$1250/\$25**

- tiny C - Interactive interpretive system for teaching structured programming techniques. Manual includes source listing. **\$75/\$40**
- BDS C COMPILER - Supports most major features of language including Structures, Arrays, Pointers, recursive function evaluation, linking loader and library. Floating point function library included. Lacks data initialization and static and register class specifiers. Documentation includes "THE C PROGRAMMING LANGUAGE" by Kernighan and Ritchie. **\$125/\$15**
- WHITESMITHS C COMPILER - The ultimate in systems software tools. Produces faster code than PASCAL with more powerful facilities. Conforms to the full UNIX C. Version 7 C language, described by Kernighan and Ritchie, and makes available over 75 functions for performing I/O, string manipulation and garbage allocation. Linkable to Microsoft files. Requires 60K CP/M. **\$630/\$30**
- POLYVUE/80 - Full screen editor for any CRT with XY cursor positioning. Includes vertical and horizontal scrolling, interactive search and replace, automatic text wrap around for word processing operations for manipulating blocks of text, and comprehensive 70 page manual. **\$135/\$15**
- POLYTEXT/80 - Text formatter for word processing applications. Justifies and paginates source text files. Will generate form letters with custom fields and conditional processing. Supports Daisy Wheel printers includes variable pitch justification and motion optimization. **\$85/\$15**
- ALGOL-60 - Powerful block-structured language compiler featuring economic memory management and allocation of memory. Very compact (24K total RAM) system implementing almost all Algol 60 report features plus many powerful extensions including string handling direct disk address I/O etc. Requires 100 CPU. **\$199/\$20**
- Z80 DEVELOPMENT PACKAGE - Consists of: (1) disk file line editor, with global inter- and in-line facilities; (2) Z80 relocating assembler, Zilog/Mostek mnemonics, conditional assembly, and cross-referenceable capabilities; (3) linking loader producing absolute Intel hex disk file. **\$95/\$20**

- MICRO FOCUS**
- STANDARD CIS COBOL - ANSI 74 COBOL standard compiler fully validated by U.S. Navy tests to ANSI level 1. Supports many features to level 2 including dynamic loading of COBOL modules and a full ISAM file format. Supports FILES which extend interactive debug and powerful interactive extensions to support protected and unprotected CRT screen formatting from COBOL programs used with any terminal. **\$850/\$50**
 - FORMS 2 - CRT screen editor. Output is COBOL data. Descriptions for copying into CIS COBOL programs. Automatically creates a query and update program of indexed files using CRT protected and unprotected screen formats. No programming experience needed. Output program directly compiled by CIS COBOL (standard). **\$200/\$20**

HOBS - Hierarchical Data Base System.

- HOBS - Hierarchical Data Base System. CODASYL oriented with FILES, SETS, RECORDS and ITEMS which are all user defined. ADD, DELETE, UPDATE, SEARCH, and TRAVERGE commands supported. SET ordering is sorted, FIFO, LIFO, next or prior. One to many set relationship supported. Read/Write protection at the FILE level. Supports FILES which extend over multiple floppy or hard disk devices. **\$850/\$50**
- MOBS - Micro Data Base System. Full network data base with all features of HOBS plus multi-level Read/Write protection for FILE, SET, RECORD and ITEM. Explicit representation of one to one, one to many, many to many, and many to SET relationships. Supports multiple owner and multiple record types within SETs. HOBS files are fully compatible. **\$850/\$50**
- MOBS-DRS - MOBS with Dynamic Restructuring System option with new ITEMS, RECORDS, or SETs are needed without changing existing data. **\$250/\$35**
- HOBS-Z80 version **\$750/\$35**
- MOBS-Z80 version **\$850/\$35**
- MOBS-DRS-Z80 version **\$850/\$35**
- 8080 Version available at \$75. extra.
- Z80 version requires 20K RAM. 8080 version requires 24K RAM. (Memory requirements are additional to CP/M and application program.)

When ordering HOBS or MOBS please specify if the version required is for 1) Microsoft (i.e. FORTRAN-80, COBOL-80, BASIC COMPILER, 2) MBASIC 4, XX, or 3) BASIC-80.0.

Prices and specifications subject to change without notice.

SUNDRIES & NOTIONS

- HEAD CLEANING DISKETTE - Cleans the absorbent Read/Write head in 30 seconds. Diskette absorbs loose oxide particles, fingerprints, and other foreign particles that might hinder the performance of the drive head. Lasts at least 3 months with daily use. Specify 5" or 8". **\$45.00**
- FLOPPY DISK KIT - Template and instructions to modify single sided 5 1/4" diskettes for use of second side in single sided drive. **\$12.50**
- FLOPPY SAVER Protection for center holes of 5 1/4" floppy disks. Only 1 needed per diskette. Kit contains contouring pool, pressure tool, tough 7-mil mylar reinforcing rings. Installation tools and rings for 25 diskettes. Re-orders of rings only. **\$1.95**
- PASCAL USER MANUAL AND REPORT - By Jensen and Wirth. The standard textbook on the language. Recommended for use by PASCAL-Z, PASCAL/M and PASCAL/MT users. **\$8**
- THE C PROGRAMMING LANGUAGE - By Kernighan and Ritchie. The standard textbook on the language. Recommended for use by BDS C, tiny C, and Whitesmiths C users. **\$12**

SuperDisk

Everything that on shopping list #10 runs on 64K TRS-80 Model II

- CP/M is a trademark of Digital Research.
- Z80 is a trademark of Intel.
- UNIX is a trademark of Bell Laboratories.
- WHAT5IT? is a trademark of Computer Headware.
- Electric Pencil is a trademark of Michael Shryver Software.
- TRS-80 is a trademark of Tandy Corp.
- CP/M for Health, TRS-80 Model I and PolyMorphic 8613 are modified and must use specially compiled versions of system and applications software.
- †† Recommended system configuration consists of 48K CP/M, 2 full size disk drives, 24 x 80 CRT and 132 column printer.
- Modified version available for use with CP/M as implemented on Heath and TRS-80 Model I computers.
- † User license agreement for this product must be signed and returned to Lifeboat Associates before shipment may be made.
- ††† This product includes/excludes the language manual recommended in Sundries and Notions above.

Lifeboat Associates

THE SOFTWARE MARKET

Orders must specify disk systems and formats e.g. North Star single, double or QDOS density, IBM single or 2/256, Altair, Helios II, Microplus Mod II, 5 1/4" disk sector (Micro/COM/SD Systems Dynabyte), etc.

Prices F.O.B. New York Shipping, handling and insurance charges extra. Manual cost applicable against separate software purchase.

The sale of any proprietary software without a license for use on one system only.

Software for most popular 8080/Z80 computer disk systems including NORTH STAR, ICOM, MICROPOLIS, DYNABYTE DB8/2 & DB8/4, EXIDY SORCERER, SD SYSTEMS, ALTAIR, VECTOR MZ, MECA, 8" IBM, HEATH H17 & H89, HELIOS, IMSAI VDP42 & 44, REX, NYLAC, INTERTEC, VISTA V80 and V200, TRS-80 MODEL I and MODEL II, ALTOS, OHIO SCIENTIFIC, DIGI-LOG and IMS 5000 formats.

The Software Supermarket is a trademark of Lifeboat Associates

Lifeboat Associates, 2248 Broadway, N.Y., N.Y. 10024 (212) 580-0082 Telex: 220501

Listing 1 continued:

```

margin_dispersal;
final_allocation
END (normalize_timings);
PROCEDURE await_cue;
BEGIN (await_start);
END (await_start);
PROCEDURE diamond_rins_burst;
BEGIN (diamond_rins_burst);
END (diamond_rins_burst);
PROCEDURE totality;
BEGIN (totality);
END (totality);
PROCEDURE summarize;
BEGIN (summarize);
WRITELN('Press return to end program');
READLN(s);
END (summarize);
BEGIN (eclipse_monitor_simulation);
initialize;
normalize_timings;
await_cue;
diamond_rins_burst;
totality;
await_cue;
diamond_rins_burst;
summarize;
END. (eclipse_monitor_simulation)

```

Listing 2: Preliminary allocation steps. The first stage of the execution of the program is this listing of an interactive sequence to determine the independent variables of the simulation.

```

Preliminary data initialization
"totality" is defined as time from second to third contacts
Enter number of exposures
250
Enter number of exposures during totality
200
Enter time of totality in "seconds.thousandths"
240
Enter slack time margin (in seconds)
6

Exposures map:
First diamond ring = 25
Totality           = 200
Second diamond ring = 25
-----
TOTAL              = 250

Press return to continue

```

Editorial text continued from page 12:

time is calculated as the difference between all the time commitments and the total time available during totality. (Half the time required for the diamond ring effects is assumed to take place during actual totality, so that the transient effects will be bracketed in time.) The margin time must be equally divided among the individual shots during totality. The procedure "margin-dispersal" is used to divide the margin by the number of totality exposures, then add this amount to the "wait-after" field of each of the ten unique totality exposure specifications in the array "ten-shot-grouping."

Finally, the procedure "final-allocation" reports on the actual allocation achieved by recalculating the margin time. This second margin time calculation reflects the allocation's effect. In photo 3, the value of 0.17 seconds is well within the limits of human hand/eye coordination by yours truly. (Hand/eye coordination will be used to

Listing 3: Final computation. Using a brute force technique of adding up various time intervals, the program arrives at this calculated model of the parameters. It first sums up the required time budget for all the events that must happen. The difference between this value and the time of totality is a margin value. This value is then evenly allocated to the timing of exposures during the main part of the eclipse. In the example, I have assumed 250 exposures total, 200 of which occur in the main portion of a 240.0 second eclipse event with a 6.0 second margin for manual timing at the end of the main sequence of totality.

```

Allocation of Eclipse Times...
Total time for eclipse = 240.000
-----
Time required for second contact transient = 5.100
Time required for third contact transient = 5.800
Total time devoted to diamond ring sequences = 10.900
Anticipation time for first diamond ring = 2.550
-----
Time devoted to totality = 202.900
Slack time margin at end of totality = 6.000
Extra slack due to diamond ring overlaps = 5.450
Total time committed before margin alloc. = 214.430
-----
Difference is time margin for allocation = 25.570
Margin per totality frame = 0.127
Adjusted time devoted to total phase = 228.380
Adjusted total time committed = 239.830
-----
Margin time after allocation to totality = 0.170
Press return to end program

```

observe the digital wristwatch set to Universal Coordinated Time and pick the precise time to start the real-time sequence of the program by hitting any key on the Apple keyboard. Later in the eclipse, the second diamond ring event (third contact) will be initiated by a similar procedure while watching the eclipsed sun.)

As it stands in listing 1, the program still must be filled out with the actual details of procedures "await-cue," "diamond-ring-burst," "totality," and "summarize." These are all relatively straightforward procedures, which will execute the real-time process of the eclipse observation. Other details to be verified include the actual model of the bulb-release exposure event (ie: what fixed overhead time is associated with the mirror flip/shutter opening action of the mechanism), calibration of a Pascal "do nothing" timing loop running with the Apple II's crystal clock so that the entire program executes all exposures within the time set by the model, and so forth. I will have more details on this in a forthcoming editorial, as I complete the model and finish verifying the system concept.

The most important concept here is the very real machine-independent viability of a high-level language, such as Pascal, in designing and then communicating the idea of a program. The functional simulation stage of my eclipse control program is now complete in concept and awaits some final details to be added over the next week or so. When it is done, going from the functional simulation to the actual eclipse control program I bring with me to Africa will be achieved by the simple act of reconfiguring the textual displays for a more limited 40-column output display and making multiple, redundant copies of the software on floppy disks for my travels.

Oregon Software Introduces

The Pascal Software Tool

OMSI PASCAL V1.2™

We at Oregon Software are pleased to announce that V1.2, our improved version of Pascal-1, is now available. The value of Pascal in computer software design is becoming widely recognized, and our V1.2 version contains significant enhancements in ease of operation and reliability.

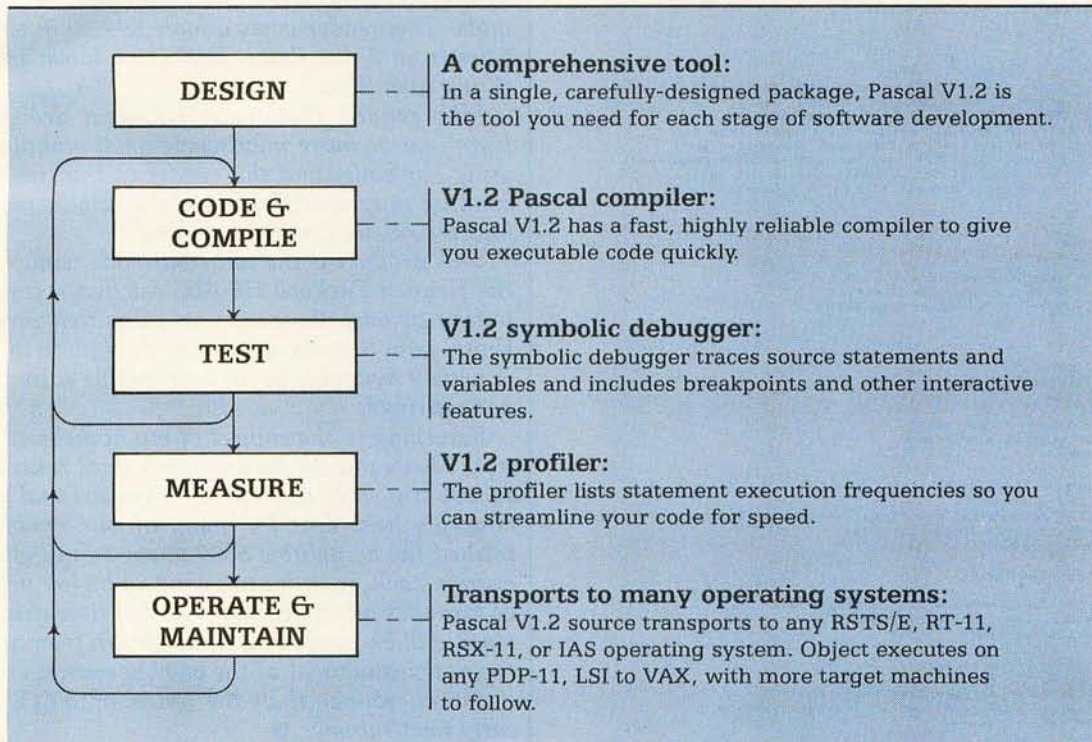

Oregon Software guarantees the performance of Pascal V1.2. We also include in the purchase price our technical support during the first year of operation.

Write or call for more details about Pascal V1.2. Ask to see our user manuals, example programs, and benchmarks.

PDP, RSTS/E, RSX, VAX, and IAS are trademarks of Digital Equipment Corporation.

Oregon Software

2340 S.W. Canyon Road • Portland, Oregon 97201 • (503) 226-7760 • TWX: 910-464-4779

INTERNATIONAL DISTRIBUTORS

Australia: Sydney;
Network Computer Services
390-3677

Canada: Vancouver;
Valley Software
(604) 524-9741

England: Stafford;
Hours Computing Ltd.
0785-44221

Japan: Tokyo;
Rikei Corporation
03-345-1411

Listing 4: A camera interface test program. This Pascal test program exercises the camera shutter control interface of figure 1 by alternating the state of Apple II Game I/O annunciator output ANO.

```

PROGRAM test_interface;
  (This program, written December 25, 1979 is designed to test out
  the interface to the Nikon MD-2 motor drive by alternately
  setting the state of output transistor Q2 in response to carriage
  return characters. A delay count set by a null FOR statement
  is used to allow repeated actuation with a minimum time between
  output state changes. A variant record technique is used in the
  Pascal software of the procedure "ref_memory" in order to set and
  reset the output bit at absolute addresses C058 and C059 hexadecimal.)
)

CONST
  open_shutter_address = -16295 (sets ANO output to "1");
  close_shutter_address = -16296 (resets ANO output to "0");

VAR
  reiterations : INTEGER;
  j,k,i : INTEGER;
  c : CHAR;

PROCEDURE ref_memory(address : INTEGER);
  ( This procedure uses the variant record technique to
  reference an address passed to it as a 16 bit signed
  INTEGER. The Apple-II hardware will set or reset the
  annunciator outputs of the Game I/O connector if the
  appropriate addresses are simply referenced by a program.
  )
)

TYPE
  ptr = ^TCHAR;

  memory_access = (pointer,number)
  (This is a dummy statement required by the syntax of
  Pascal variant records such as "memory" below. The
  variant record "trick" is not the most elegant way to
  reference an absolute hardware address, since it
  requires an implementation-dependent assumption about
  variant records, ie: that a 16 bit signed two's complement
  INTEGER type maps bit for bit into the 16 bit positive
  integer value of an address stored in a Pascal pointer
  data type.
  );

  memory =
  RECORD
    CASE memory_access OF
      pointer : (a_pointer : ptr);
      number : (a_number : INTEGER);
    END;
  END;

VAR
  anybyte : memory;
  anychar : CHAR;

BEGIN
  anybyte.a_number := address;
  anychar := anybyte.a_pointer;
END (ref_memory);

PROCEDURE end_exposure;
  BEGIN
    WRITELN('Motor drive now fires... and shutter cocks');
    ref_memory(close_shutter_address);
  END (end_exposure);

PROCEDURE start_exposure;
  BEGIN
    WRITELN('Shutter opens with a "click"');
    ref_memory(open_shutter_address);
  END (start_exposure);

PROCEDURE change_reiterations;
  BEGIN
    WRITELN('Enter integer time delay count');
    WRITELN(' (old count was = ',reiterations,' )');
    READLN(reiterations);
    IF reiterations < 1 THEN reiterations := 1;
    IF reiterations > 2500 THEN reiterations := 2500;
  END (change_reiterations);

BEGIN
  reiterations := 1000;
  FOR i := 1 TO 1000 DO
    BEGIN
      FOR j := 1 TO reiterations DO;
        WRITELN('*** Shutter is now closed ***');
        READLN(c);
        IF c = ' ' THEN
          ELSE IF c = 'N' THEN change_reiterations;
          ELSE IF c = 'E' THEN i := 1000;
        start_exposure;
      FOR j := 1 TO reiterations DO;
        WRITELN('***** Shutter is now open *****');
        READLN(c);
        IF c = ' ' THEN
          ELSE IF c = 'N' THEN change_reiterations;
          ELSE IF c = 'E' THEN i := 1000;
        end_exposure;
      END;
    END;
  END;
END.

```

Bar Codes and Home Brewing . . . Progress Reports

As of early December 1979, we received some exciting word about the state of manufacturing of bar-code-reader wands. This word comes from John Sien of Hewlett-Packard's Optoelectronics Division in Palo Alto, California. Hewlett-Packard has just completed the formal announcement of a truly inexpensive optical bar-code reader, which will be available from stocking distributors of their component lines, possibly by the time you are reading this issue of BYTE.

The bar-code reader interfaces to transistor-transistor logic (TTL) or complementary metal-oxide semiconductor (CMOS) logic with three wires: signal, ground and power. It enables an individual with a personal computer to read Universal Product Codes (as on grocery items) or PAPERBYTES bar codes, or a host of other possible machine-readable printed formats. This reader costs a mere \$99.50 in single quantities from a distributor and much lower in manufacturing quantities.

John reports that there is a great deal of interest from one or more microwave-oven manufacturers in using bar codes and this reader to transfer individual cooking programs from food-packets or recipe books into the oven's control circuitry.

This product is the same bar-code reader used with the Hewlett-Packard HP-41C calculator for the distribution of miscellaneous user-submitted programs. In short, now that the single enabling piece of hardware is widely available in an inexpensive form, bar codes have arrived.

Returning to the subject of my homebrew 6809 project, I have put off further work until return from the eclipse trip early this month. In a personal analogy to concepts held dear by many of our readers, I have pushed the homebrew 6809 down on my internal procedure stack, in order to execute a higher priority procedure that has a definite, celestial time deadline. The stack will be popped up upon return from my trip, so the next installment of the 6809 homebrew project can occur no sooner than the issues of BYTE published early next summer. ■

Articles Policy

BYTE is continually seeking quality manuscripts written by individuals who are applying personal computer systems, designing such systems, or who have knowledge which will prove useful to our readers. For a more formal description of procedures and requirements, potential authors should send a large (9 by 12 inch, 30.5 by 22.8 cm), self-addressed envelope, with 28 cents US postage affixed, to BYTE Author's Guide, 70 Main St, Peterborough NH 03458.

Articles which are accepted are purchased with a rate of up to \$50 per magazine page, based on technical quality and suitability for BYTE's readership. Each month, the authors of the two leading articles in the reader poll (BYTE's Ongoing Monitor Box or "BOMB") are presented with bonus checks of \$100 and \$50. Unsolicited materials should be accompanied by full name and address, as well as return postage.

ITEM NO.
WK-7

CMOS SAFE

IC INSERTION/EXTRACTION KIT

- KIT INCLUDES**
- MOS-1416 14-16 CMOS SAFE INSERTER
 - MOS-2428 24-28 CMOS SAFE INSERTER
 - MOS-40 36-40 CMOS SAFE INSERTER
 - EX-1 14-16 EXTRACTOR
 - EX-2 24-40 CMOS SAFE EXTRACTOR



OK MACHINE & TOOL CORPORATION
3455 CONNER ST., BRONX, N.Y. 10475 U.S.A.
PHONE (212) 994-6600 TELEX NO 125091



PRINTED IN U.S.A.

PATENT PENDING

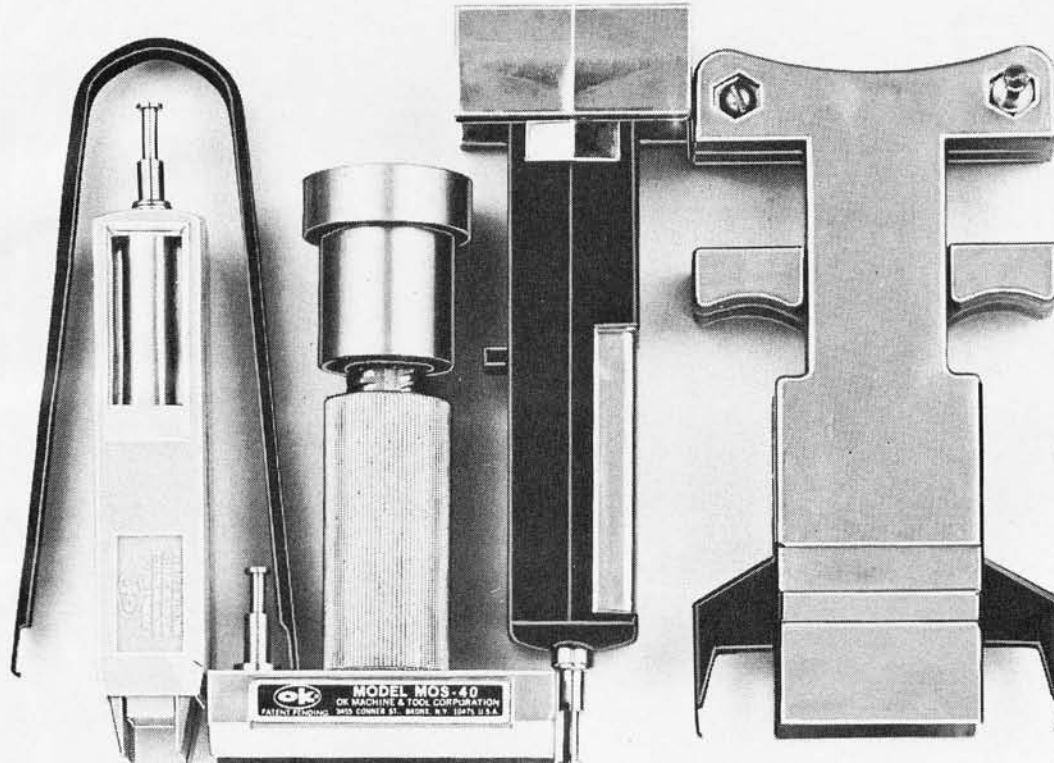

INS-1416	14-16 PIN DIP IC INSERTER	\$ 3.49
MOS-1416	14-16 PIN MOS CMOS SAFE INSERTER	\$ 7.95
MOS-2428	24-28 PIN MOS CMOS SAFE INSERTER	\$ 7.95
MOS-40	36-40 PIN MOS CMOS SAFE INSERTER	\$ 7.95
EX-1	14-16 PIN EXTRACTOR TOOL	\$ 1.49
EX-2	24-40 PIN CMOS SAFE EXTRACTOR TOOL	\$ 7.95
WK-7	COMPLETE IC INSERTER/EXTRACTOR KIT	\$29.95

MINIMUM BILLING \$25.00. ADD SHIPPING CHARGE \$2.00. NEW YORK RESIDENTS ADD APPLICABLE TAX.

OK MACHINE & TOOL CORPORATION 3455 CONNER ST., BRONX, N.Y. 10475 (212) 994-6600/TELEX 125091



ALLOS
COMPUTER SYSTEMS

*Z80 is a registered trademark of Zilog, Inc.
**CP/M is a registered trademark of Digital Research, Inc.

ALTOS BREAKS THE MICRO BARRIER.

Yesterday, microcomputer meant micro performance. Once you outgrew it, you had to step up to a mini. Which meant a big step up in price.

Today, there's the new Altos ACS8000-6 single-board microcomputer system.

It's the first system for the OEM, small businessman and personal user, that offers minicomputer performance and minicomputer storage capacities—at a microcomputer price.

MULTI-USER, WINCHESTER STORAGE, FLOPPY BACK UP: \$14,260.

The new Altos ACS8000-6 is a highly advanced Z80* based microcomputer system with high-speed RAM, floppy disk and Winchester hard-disk controllers, DMA, six serial and two parallel I/O ports and the AMD 9511 floating point processor all on a single board. A typical four-user system configuration with two megabytes of Shugart floppy and 29.0 megabytes of Shugart Winchester storage, including CPU and 208K bytes of RAM, costs only \$14,260—compared to \$30,000 or more for a similar minicomputer system. And that adds up to mini performance at less than half the cost!

MULTI-USER EXECUTIVE SUPPORTS FOUR INDEPENDENT USERS RUNNING CP/M COMPATIBLE PROGRAMS.**

This revolutionary new microcomputer system features an Altos-developed Multi-User Executive (AMEX) software program that's unique in two ways. It includes a multi-user CP/M capability and the ability to handle Winchester-type hard disks. This advanced Z80 operating program supports four independent CP/M compatible programs in any of six popular

languages: BASIC, FORTRAN, COBOL, PASCAL, APL, C, and a large assortment of additional business application packages. AMEX is compatible with both the 1.4 and 2.0 versions of Digital Research's CP/M, which means programs based on either version can run under AMEX without modification.

With AMEX at the helm, your Altos ACS8000-6 system can support up to four simultaneous users with 48K bytes of RAM each plus 58 megabytes of Winchester storage and 4 megabytes of floppy back up. And that adds up to the first microcomputer to give you the power and performance of a minicomputer.

SINGLE-USER, HARD-DISK SYSTEMS START AT \$9450.

The Altos ACS8000-6 series. It's a barrier breaker in every sense. Our entry-level, single-user, hard-disc system with floppy back up is priced under \$10,000 and even our 4-user CP/M model is available for under \$12,000. And all configurations are easily upgraded. For specific details about pricing or performance, call or write:

Altos Computer Systems,
2360 Bering Drive, San Jose, CA
(408) 946-6700. TELEX 171562 ALTOS SNA.

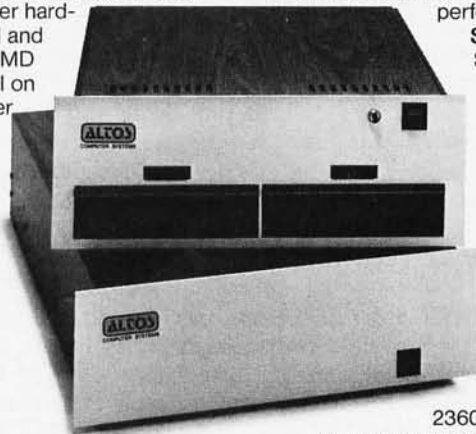

ALTOS
COMPUTER SYSTEMS

BYTE News . . .

FRANCE TO INTRODUCE HOME TERMINALS: The French Postal and Telecommunications agency is undertaking a project to put a computer terminal in every home. According to a report that appeared in *Business Week* magazine, the government agency intends to give all telephone customers a free two-way video display terminal, in lieu of printed directories. A similar machine that can send and receive a full page of text in two minutes will also be offered for under \$500. Over 1000 terminals will be installed early next year. Each terminal is expected to cost the agency less than \$100.

IBM MOVES TO ASCII: Until now you either did it the ASCII way or the IBM way. In other words, all IBM communication was done in Extended Binary-Coded-Decimal Interchange Code (EBCDIC), while all other computer manufacturers used the American Standard Code for Information Interchange (ASCII). Anyone who has tried to interface an IBM terminal to a non-IBM system has encountered the problem.

Now IBM has introduced their first product that uses ASCII, the model 3101 video terminal. Depending on options, prices range from \$1300 to \$1520. These units can be ordered over the telephone, and IBM installation is not required, as is the case with all other IBM products. The unit, largely made in Japan, qualifies for discounts up to 20%—a new departure for IBM.

IBM has apparently been forced to compete with other computer component makers on their level. This may be the forerunner of a new IBM marketing philosophy for small-computer systems.

Rumor has it that IBM will become more aggressive in the small-computer market with enhancements to its 5110 tabletop computers. Look for IBM to increase the number of "retail stores" for small-business computer systems to 200 by the end of 1980. Most of these stores will be in branch offices of the General Systems Division.

TANDY, APPLE AND ATARI ASK FCC FOR DELAY: Atari asked the Federal Communications Commission (FCC) to delay the effective date of the waiver of rules for Texas Instruments (as previously reported in the January 1980 *BYTE News*) until a rulemaking proceeding on television-interface devices is completed. Atari cited allegedly illegal action by the FCC in granting the waiver and noted the potential increased radio and television interference. After two weeks consideration, the FCC rejected Atari's request.

Tandy Corporation and Apple Computer Company asked the FCC to delay the deadline for compliance with the FCC's new radio frequency interference (RFI) standard, which is due to go into effect on July 1, 1980. Both firms have claimed that this is too short a time to change manufacturing processes and order the necessary components.

LATEST RUMORS: Designers of Radio Shack's successor to the TRS-80 Model I have changed their minds and will employ Microsoft for writing the BASIC interpreter and operating system. Motorola also made a bid to do this software development; however, Microsoft ended up with the contract. Radio Shack had been planning to call the unit the "TRS-90," but the firm is now leaning toward "TRS-80/COLOR." . . . It is rumored that Sony and Texas Instruments have reached an agreement whereby Sony will sell Texas Instruments' personal-computer systems in the United States under the Sony name, with a Sony Trinitron color video monitor, instead of the Zenith monitor Texas Instruments is currently using. . . . Microtype Corporation will soon introduce a \$250 electronic typewriter with RS-232 input/output (I/O). It will use a daisy-wheel-like printing method, and it will print 15 characters per second. Look for it by the end of 1980. . . .

RANDOM NEWS BITS: Burroughs has introduced a 6 megabyte floppy-disk drive. It holds two disks on a common spindle and uses four data-transfer heads on a common assembly. Cost is only \$1950 in original equipment manufacturers quantities. . . . GR Electronics Ltd of Santa Monica, California, has introduced a pocket ASCII terminal in a case the size of a standard pocket calculator. It has forty keys and transmits the 128 ASCII character codes. It has an light-emitting diode display and stores thirty received characters. It has an RS-232C interface (110 or 300 bits per second), requires 5 V at 400 mA for power, and sells for \$395. . . . Hewlett-Packard (HP) has introduced its personal-computer system. The system costs \$3250 and is being manufactured at HP's Corvallis, Oregon, calculator division. See page 60 in this issue for a report. . . . Godbout Electronics, Oakland Airport, California, plans to introduce an S-100 processor circuit card that contains both 8088 and 8085 microprocessors on the same card. The 8088 is a 16-bit processor with 8-bit I/O (it executes 8086 ob-

MICROSOFT. NOBODY DOES IT BETTER.

In 1975, Microsoft wrote the first BASIC interpreter for the 8080. Today, hundreds of thousands of microcomputers run with Microsoft software. And tomorrow—a full line of system software for the 8086 and Z8000. With microcomputer software, nobody does it better.

BASIC Compiler Microsoft's BASIC compiler is the ideal software tool for the development of BASIC applications programs for resale. Compiled object code for any application may be distributed to your customers on diskette or ROM, thus safeguarding the source program. And execution speeds with our compiled BASIC code are faster than with any other BASIC. Highly optimized, compact object code means maximum efficiency in any application. The BASIC Compiler supports all the language features of our BASIC-80 Interpreter. Comes with macro assembler and loader. Runs with CP/M, ISIS-II, TRSDOS. \$395.

BASIC Interpreters for 8080, Z80, 8086, 6800, 6809 Language features above and beyond any other BASIC have made Microsoft's BASIC the world's most popular interpreter. And now three new versions are available for the 8086, 6800, and 6809. The latest releases of BASIC-80 and BASIC-86 support the new WHILE conditional, plus CHAINing of programs with COMMON variables, dynamic string space allocation and variable length records in random files. All versions have double precision arithmetic, full PRINT USING, tracing, renumbering, edit mode, and many other features. BASIC-80 for CP/M, ISIS-II, TEKDOS: \$350. BASIC-86 standalone on SBC 86/12: \$600. BASIC-68 for FLEX: \$200. BASIC-69 for FLEX: \$250.

COBOL-80 Compiler The best implementation of the world's most widely used programming language is COBOL-80 from Microsoft. As small business applications become not-so-small, COBOL-80 is ready with powerful use of disk files, data manipulation facilities, CHAIN, segmentation and interactive ACCEPT/DISPLAY. Plus three-dimensional arrays, full COPY facility, indexed and relative files and an optional packed decimal format that saves on mass storage by as much as 40%. Comes with macro assembler and loader. Runs on CP/M, ISIS-II, and TRSDOS. \$750.

NEW muSIMP/muMATH-79

At last, a sophisticated math package for microcomputers. muMATH performs mathematical operations efficiently and accurately. Use it to solve equations and simplify formulas; or perform exact arithmetic, symbolic integration and differentiation, infinite precision integer arithmetic and symbolic matrix inversion. muMATH is an invaluable tool for engineering and scientific applications involving lengthy, analytical computations. It is also an ingenious teaching method for all levels of math from arithmetic to calculus. muMATH is implemented in muSIMP, a highly structured language for complex symbolic manipulations. muSIMP/muMATH Package, CP/M versions: \$250.

NEW muLISP-79 LISP—the lingua franca of the artificial intelligence world—is now available in this efficient, low-cost version for microcomputers. Features include dynamic allocation of storage resources; program control structures such as an extended COND and a multiple exit LOOP; user functions defined as CALL by Value or CALL by Name; and 83 LISP functions. muLISP-79, CP/M version: \$200.

NEW XMACRO-86 For the development of 8086 programs, our new XMACRO-86 cross assembler has just been released. It supports the same features as our MACRO-80 assembler. Develop 8086 programs now on your current CP/M, ISIS-II, or TEKDOS system. \$300.

NEW Micro-SEED DBMS If you are developing applications software in-house or bundling hardware and software for resale, a database manager could be the software tool you've been looking for. Micro-SEED is the first CODASYL compatible database management system to run with CP/M; and Microsoft's FORTRAN-80 has been implemented as the host language. When an application becomes limited by traditional floppy disk file handling, but remains overpowered by the cost and maintenance of a minicomputer, the solution is Micro-SEED. \$900.

FORTRAN-80 Compiler Microsoft FORTRAN-80 is the most complete microcomputer FORTRAN available. It has all of ANSI-66 FORTRAN (except COMPLEX data), plus unique enhancements for use in the microcomputer environment. An extensive library of single and double

precision scientific functions, too. Comes with macro assembler and loader. Versions for CP/M, ISIS-II, TEKDOS. \$500.

MACRO-80 Assembler The most powerful microcomputer assembler on the market today is Microsoft's MACRO-80. It is fast, and it supports Intel-standard macros, relocation pseudo-ops, conditionals and listing controls. MACRO-80 comes with a relocatable linking loader and runs with CP/M, ISIS-II, and TEKDOS. \$200.

EDIT-80 Text Editor Random access to floppy disk files makes EDIT-80 the fastest microcomputer text editor. It's the essential tool for creating and maintaining all files. EDIT-80 includes FILCOM, a file compare utility. EDIT-80, CP/M version: \$120.

Prices quoted are USA domestic only. OEMs should contact Microsoft for prices.

MICROSOFT OS	CP/M	ISIS-II	TRSDOS	TRSDOS Md II	TEKDOS
BASIC-80 INTERPRETER	●	●			●
BASIC COMPILER	●	●		●	
FORTRAN-80 COMPILER	●	●			●
COBOL-80 COMPILER	●	●		●	
muMATH/muSIMP muLISP	●		●		
MICROSEED DBMS	●				
EDIT-80 TEXT EDITOR	●				
MACRO-80 ASSEMBLER	●	●			●

MICROSOFT

10800 NE 8th
Suite 819
Bellevue, WA 98004
206-455-8080
Telex 328945



We set the standard.

ject code). A user can run the standard CP/M operating system on the 8085 to handle all I/O devices, and use the 8088 to run software such as a multi-user BASIC system. The processor card will drive 24 address lines (16 megabytes of memory space), and has a direct-memory-access (DMA) peripheral controller. . . Heath Company has decided to resume production of the H8 8080-based microcomputer system. Surprisingly, the sales of the H8 have increased, despite the introduction of the Heath/Zenith H89 integrated Z80-based system. Apparently, with its plug-in bus construction, the H8 is more to the liking of hobbyists who prefer to configure their own systems. Also, Zenith is now producing the assembled Heath H19 video terminals on one of its television set production lines. . . Mattel Electronics and General Instrument are about to start testing a television attachment that can receive a variety of video games sent over cable television. . . McGraw-Hill, *The New York Times*, *Times-Mirror*, and *Time Magazine* are considering setting up systems which would allow personal-computer users to access their data bases.

HIGH-DENSITY 5-INCH DISK DRIVES: Micropolis Corporation and several other floppy-disk drive makers have announced 5-inch floppy-disk drives with a density of 96 tracks per inch (tpi). Forty-eight tracks per inch has been standard, while some firms have sold 77 tpi drives.

The Micropolis disk system will read older 48 tpi disks by skipping every other track under software control. The new drives will range in capacity from 436 K to 1064 K unformatted bytes and will cost between \$450 to \$570 each.

PERSONAL COMPUTER SYSTEM DELIVERIES DELAYED: Texas Instruments (TI), Mattel Electronics, and Atari have all experienced delayed deliveries of their personal computer systems in the past few months. Delays were due to a shortage of parts, which restricted production of these new systems. Atari did not start shipping units until October 1979, and TI did not start until November. Quantities were severely limited during the Christmas season. Mattel did not even start shipping until after Christmas. In all cases, the companies claimed that "silicon shortages" caused the delays. TI and Atari had promised to start deliveries in August. This problem is common throughout the computer industry, due to an unexpectedly high demand for integrated circuits.

DATA-STORAGE ADVANCES PREDICTED: A San Jose, California, market research firm has released an interesting report on the future of microcomputer storage systems. Creative Strategies International predicts that during the next two years we will see the introduction of new, low-cost 5-inch and 8-inch Winchester-technology disks, new sizes (4-inch and 6-inch) of Winchester drives, "back-end" processors (disk controller and data base manager), and on-line archives in both video-disk and cartridge-tape form.

Low-cost, 5-inch floppy-disk drives and digital cassettes are expected from Japan. They will be mass-produced for intelligent-typewriter and home-computer applications. Prices of floppy-disk and Winchester disk drives are expected to drop to less than one-third of current prices.

The new small Winchester disk drives, or micro-Winchesters, will have storage capacities starting at 1 megabyte and removable disk modules about the size of an 8-track audio tape cartridge. The back-end processors will be available by the mid-1980s. They will combine Winchester-disk-controller and data-base-management functions in large-scale integrated circuits, with fast parallel architecture, content-addressed memory, charge-coupled memory systems or bubble memory. On the other hand, 8-inch floppy disks should reach the 5 megabyte capacity by the mid-1980s.

BUBBLE MEMORY STATUS REPORT: Bubble memory has developed considerably during the past year. Device size has jumped from 64 K bit, serial shift-register architectures to 1 megabit major/minor-loop, block-replicate architecture. Four megabit devices, organized as 4- and 8-bit words, are expected next year. Access times have dropped from hundreds of milliseconds; under 10 milliseconds is expected by the end of 1980. Five companies, Fujitsu, Intel, Plessey, Rockwell and Texas Instruments, are now competing for a share of the developing bubble memory business. Three more companies, Hitachi, Motorola, and Siemens, are expected to enter the market this year.

SPEECH-SYNTHESIS TECHNOLOGY IMPROVING: A year and a half ago when Texas Instruments introduced its Speak & Spell toy with voice output, the experts were amazed at its voice quality and low cost. Now single-board synthesizers, which can be easily interfaced to computers, are available from Texas Instruments, the Votrax Division of Federal Screw Works in Troy, Michigan, and Telesensory Systems Inc (TSI) of Palo Alto, California (TSI specializes in products for aiding the blind). Even IBM has added voice output to a typewriter. Further, Texas Instruments has now made available a low-cost voice synthesizer chip set for use by game and appliance manufacturers.

The Texas Instrument synthesizer stores words in its memory and thus is limited to 180 standard words, plus up to 180 words stored in external read-only memory. On the other hand, the Votrax unit is programmed with 62 phonemes (sound units) and can form an unlimited number of words.

NEW POWER FOR YOUR APPLE FROM MOUNTAIN HARDWARE.

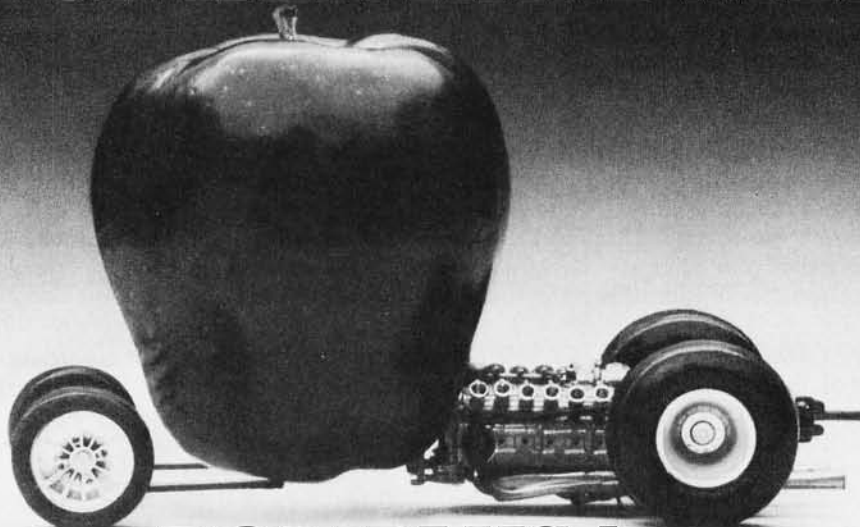

ROMPLUS+

NEW EXPANDABILITY.

ROMPLUS+ is a peripheral board whose added features can turn the Apple * computer into the most powerful personal computer available today.

NEW POWER.

ROMPLUS+ provides six sockets to accept individually addressable 2K ROM's or EPROM's. Keyboard Filter™, a 2K ROM program, comes installed on the ROMPLUS+ board and adds many useful features to your Apple, including:

- Upper and lower case letters. The only system that offers keyboard input and standard shift key operation.
- Multiple user-defined character sets.
- Colored or inverse-colored letters.
- Keyboard macros—two key-stroke, automatic typing of multiple, user-defined words or phrases. Including BASIC and DOS commands.
- Mixed text and graphics.
- Improved cursor control.
- STOP LIST and END LIST.

- Works with Integer BASIC, RAM or ROM Applesoft, and DOS.
- And more...quick to learn. Easy to use.
- Software support provided on disk includes demonstration programs and two Editors that allow you to define your own characters or keyboard macros.

SOPHISTICATED FIRMWARE.

In addition to the Keyboard Filter ROM, ROMPLUS+ offers five sockets for ROM or EPROM, plus "scratch-pad" RAM. And, sophisticated firmware on ROMPLUS+ allows one, two, or more of its chips to be used simultaneously for programs longer than 2K.

EXPANDED UTILITY.

Many software programs really ought to be utilized as firmware. ROMPLUS+ makes that an actuality for the Apple by providing six additional ROM sockets.

AT YOUR DEALER. NOW.

\$169. Complete and tested. Including the powerful Keyboard Filter ROM and full documentation. Ask your dealer for a demonstration.

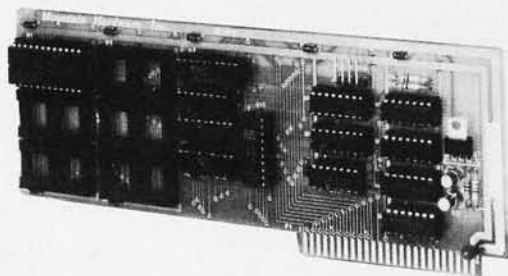

Mountain Hardware, Inc.

LEADERSHIP IN COMPUTER PERIPHERALS
300 Harvey West Blvd., Santa Cruz, CA 95060
(408) 429-8600

Sounds great.

Please send me all the details on ROMPLUS+ and Keyboard Filter.

Name _____

Address _____

City _____ State _____ Zip _____

Phone _____

*Trademark of Apple Computer Inc.

The voice quality of present units is acceptable but still leaves much to be desired. Most listeners agree that the Texas Instruments' unit produces better quality voices. There is no doubt that next year we will see a larger number of devices and appliances with voice output on the market, some possibly with voice input.

ANALOG MEMORY DEVELOPED: Sanyo Electric Company of Tokyo, Japan, recently reported at a Institute of Electrical and Electronics Engineers conference that it has developed a nonvolatile analog memory. The memory permits the direct storage of analog signals, eliminating the current technique of digitizing the analog signal and storing it in binary form. Analog memory could greatly simplify the circuitry used in voice and music synthesizer equipment, as well as in such applications as television tuning.

TANDY TO ENTER DISK DRIVE BUSINESS: Tandy Corporation has agreed to form a joint floppy-disk manufacturing venture with Datapoint Corporation. Final approval is still pending from the boards of directors of both companies. Tandy currently buys floppy-disk drives for its Radio Shack computers from Shugart Associates, Control Data, and Tandon Magnetics. Datapoint makes their own units under a license from Shugart. Last year, Tandy attempted to purchase Perkins Elmer's Orbis floppy-disk operation for \$2.2 million, but was outbid (\$2.5 million) by Siemens.

DUAL-SIDED FLOPPY-DISK AVAILABILITY IMPROVES: In 1977, floppy-disk manufacturers started showing prototypes of their dual-sided floppy-disk drives. Shipments started in early 1979, but the firms soon ran into production problems. The double-sided drives caused excessive wear on disks and had other reliability problems. Manufacturers now have apparently learned how to manufacture these drives reliably and are finally getting into quantity production.

Last year a total of nearly 250,000 8-inch drives and 500,000 5-inch drives were made. It is expected that well over 1 million 5-inch drives will be made this year, and that nearly 30% will be double-sided.

RADIO SHACK TAKES ACTION TO PROTECT TRS-80 TRADEMARK: At the opening of a recent microcomputer show in Boston, federal court injunctions were served to three exhibitors, ordering them to immediately stop selling or distributing anything with the characters "TRS-80" written on it, and to hand over all such items and literature to Tandy-Radio Shack for disposal. Further, Radio Shack demanded \$10,000 for damage done to Radio Shack by each of the three companies.

Radio Shack claimed the companies were using the TRS-80 trademark illegally and in such a manner that people would think they were buying Radio Shack products. Further, Radio Shack claimed that business was being stolen from them, and that should the products prove defective, Radio Shack's reputation would be damaged.

The exhibitors had no prior warning of the injunction. Two of the exhibitors immediately appealed the injunction, pointing out that Radio Shack was clearly credited as the trademark owner in all advertising; the injunction was rescinded. The third exhibitor, who failed to take immediate legal action, was prevented from selling his regular merchandise at the show; instead he substituted a line of goods contained in packages not bearing the legend "TRS-80."

16-BIT MICROPROCESSOR STATUS REPORT: Intel has been producing its 8086 16-bit processor in volume since the spring of 1979. The 8086 has been successful but it is generally considered to be a less powerful device than either the Zilog Z8000 or Motorola 68000. While Zilog has been providing samples of the Z8000 for over six months, the firm is only now beginning volume production. Reportedly the samples did not execute all instructions correctly. Motorola has been sampling the 68000 for several months, and production quantities are expected soon. Recipients of sample devices from Motorola have reported that some instructions do not execute correctly and that the device will not operate at maximum rated speed. The companies are aware of these problems, and actual production units are expected to operate properly.

Other problems slowing the adoption of the Zilog and Motorola processors are lack of availability of peripheral devices (such as the Zilog memory-management integrated circuit), lack of software, and the fact that second-source suppliers are still far from production.

MAIL NOTE: I receive a lot of mail each month, as a result of this column. If you write to me and wish a response, enclose a self-addressed, stamped envelope.

Sol Libes
Amateur Computer Group of New Jersey
(ACG - NJ)
1776 Raritan Rd
Scotch Plains NJ 07076

SCIENTIFIC AMERICAN



PHYSICS OF SOMERSAULTING

\$2.00

March 1980

Do divers and gymnasts violate the law?

physics is the same for the astronauts in space who need to control their body orientation in a weightless environment.

In the same issue you will find that impaired communication among cells can be a cause of a variety of diseases, as widely different from

each other as cholera, diabetes and manic-depressive psychosis. In each there occurs a form of failure of fit between signal-bearing molecules from one cell and the receptor molecules in the outer or internal membranes of the target cell.

You will learn how British archaeologists have plumbed the past that lies under the city of York, down through the medieval city of Jorvik and on below to Eboracum, the great fortress city that held the northernmost boundary of the Roman Empire.

You will read about the spin of comets in their eccentric orbits around the sun... About the virtuosity with which the horned beetles put their horns to work, especially in courtship contests... About the

perception of the elusive "gluon" that glues quarks together... About the quantization of risk and safety of nuclear reactors in the wake of the Three Mile Island episode.

This is the kind of diversity our more than 700,000 readers enjoy each month in our pages.

Why not join us at the frontiers of knowledge? You will see why The New York Times calls our magazine, "This country's and perhaps the world's outstanding forum for communication between scientists and the intelligent public."

A one-year subscription, at \$18, saves you \$6 on the newsstand price of \$2.00. A two-year subscription, at \$33, saves \$15. And a three-year subscription, at \$45, saves you \$27.

Use the coupon below, or call toll free: 1-800-648-5311.

(In Nevada call 800-992-5710.)

Send no money. We'll bill you.

We are accustomed to seeing divers and gymnasts begin to twist and somersault long after they have left the springboard or the floor. Indeed, in order to win gold medals divers need to perform such complex feats in midair as the forward two-and-a-half somersault with two twists. But, you may ask, doesn't this violate the law of conservation of angular momentum? It postulates: *In the absence of torques, or rotational forces, the angular momentum of a body is conserved.* In the March SCIENTIFIC AMERICAN you will see how this paradox is resolved. You may be relieved to learn that divers and gymnasts (and free-falling cats, too) perform their midair rotations without violating any laws of physics. Moreover, the underlying

SCIENTIFIC AMERICAN

WITH YOUR SUBSCRIPTION ... THIS FREE BOOK

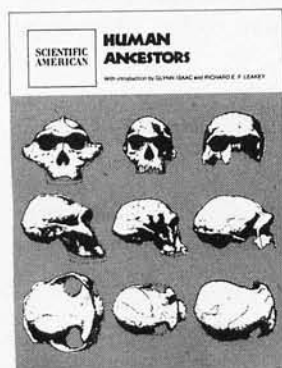

As soon as your subscription payment is received, we will also send you *Human Ancestors* (regular price: \$5.00) as a bonus. This 144-page anthology reports the archaeological discoveries that unveiled the evolutionary stream leading to *Homo sapiens*, culminating in the growing recognition of the role of toolmaking in the process of natural selection.

SUBSCRIPTION RESERVATION SCIENTIFIC AMERICAN

415 Madison Avenue, Dept. GS, New York, N.Y. 10017

Yes, enter my subscription to the monthly issues of SCIENTIFIC AMERICAN for the term I have checked. As soon as my payment is received, you will also send me—absolutely free—the 144-page book *Human Ancestors* (regular price: \$5.00).

MY GUARANTEE

I may cancel my subscription to SCIENTIFIC AMERICAN at any time and receive a refund for the unused balance. The bonus book is mine to keep.

Name _____

Address _____

City/State/Zip _____

- Start my subscription with the March issue.
- 1 year—\$18 2 years—\$33 3 years—\$45
(save \$6) (save \$15) (save \$27)
- My payment is enclosed Bill me
(International rates outside U.S. and Canada:
1 year—\$22 2 years—\$40 3 years—\$55) **GS**

Electronic Planimetry

Peter A Santi
John Fryhofer
Gregory Hansen
Medical Research East
University of Minnesota
2630 University Ave SE
Minneapolis MN 55414

A planimeter is an instrument (formerly mechanical) for measuring the area of a two-dimensional figure by tracing its perimeter. Area measurements obtained from planimeters are useful for a variety of applications, such as cartography, geology, metallurgy and biology. Our biomedical application requires area and length measurements of irregularly shaped two-dimensional figures. To this end an *electronic planimeter* has been designed consisting of a Summagraphics Bit Pad and a Terak microcomputer programmed in UCSD Pascal (Version I.5).

In practice, a user specifies a scale factor and then traces the boundary line of a figure using either a stylus or a single-button cursor. To improve the accuracy of the area measurement, the program detects closure (ie: when the end of the tracing meets the beginning) and displays the calculations. You can trace additional figures with the same scale by using only the stylus or cursor switch. Using this electronic planimeter, area and perimeter length measurements are more accurate and can be obtained faster than with a mechanical planimeter.

The Terak Microcomputer

The Terak 8510 (see photo 1) is a

completely self-contained, 16-bit microcomputer using a Digital Equipment Corporation (DEC) LSI-11 with the hardware floating-point option. The Terak contains 56 K bytes of memory, a single 8-inch floppy disk drive, 128-character ASCII keyboard, 12-inch video monitor with a 320-by-240 graphics dot matrix, a 24-line-by-80-character display, and an RS-232C and 20 mA serial interface. The cabinet also houses an additional serial or 16-bit parallel interface card. The Terak is supported by the DEC RT-11 operating system and UCSD Pascal.

The Terak is well suited for UCSD Pascal, which can be purchased for a reasonable price. The Terak is a conservative, but well-designed system which performs with a high degree of reliability. It serves as a general-purpose laboratory computer and in this application as a host computer for the Summagraphics Bit Pad digitizer.

The Summagraphics Bit Pad

The Bit Pad includes a digitizing surface or data tablet, control unit, power supply, and writing stylus or a single-button cursor. The control unit consists of an 8-bit microcomputer (Intel 8035), a control program in erasable, programmable read-only

memory, and binary counters. The control unit generates X and Y coordinate points of the location of the stylus or cursor as it travels across the tablet surface. These coordinate points are generated as serial or parallel data and can be used by a host computer for a variety of applications.

Theory of Operation

The Bit Pad operates on a magnetic principle. Current is pulsed along a *send* wire that lies perpendicular to a mesh of magnetostrictive wires lying beneath the writing surface of the tablet. The current pulse changes the dimensions of the magnetostrictive material and a strain wave simultaneously propagates down all the wires in one direction. This propagated strain wave is sensed by a *receive* coil in the stylus or cursor. The control unit times the delay

Terak is a registered trademark of Terak Corporation.

RT-11 and LSI-11 are registered trademarks of Digital Equipment Corporation.

Bit Pad is a registered trademark of Summagraphics Corporation.



*Superbrain is a registered trademark of Intertec Data Systems.

SUPERBRAIN™

The Honor Graduate

OEM's...

End Users...

Computer Dealers...

\$2995!

SuperBrain users get exceptional performance for just a fraction of what they'd expect to pay. Standard system features include: two double density mini-floppies with 285 K bytes of disk storage, 64K of RAM memory to handle even the most sophisticated programs, a CP/M Disk Operating System with a high powered text editor, assembler, debugger and a disk formator. And, with SuperBrain's S-100 bus adaptor, you can add all the programming power you will ever need... even a 10 megabyte disk!

SuperBrain's CP/M operating system boasts an overwhelming amount of available software in BASIC, FORTRAN, COBOL, and APL. Whatever your application... General Ledger, Accounts Receivable, Payroll, Inventory or Word Processing... SuperBrain is tops in its class. But best of all, SuperBrain tackles your toughest jobs for less than one-third the cost of other similar systems.

You'll appreciate the careful attention given to every engineering detail. Standard SuperBrain features include: a full ASCII keyboard with numeric pad and user-programmable function keys. A non-glare, dynamically focused, 12-inch CRT for sharp images everywhere on the screen. Twin Z80 microprocessors to insure efficient data transfer to auxiliary peripheral devices. A universal RS-232 communications port for serial data transmission. And, a single board design to make servicing a snap!

Performance and packaging have never been better matched. Your operators will appreciate SuperBrain's good looks. You'll appreciate SuperBrain's outstanding value. Twin Z80 processors, dual double density disk drives, and a high resolution CRT terminal. All in a single, smart looking, self-contained desktop unit. And, all for a price that's substantially less than the competition!

Make no mistake about it. The freshman students in the small systems business can't begin to compete with this year's honor graduate. The SuperBrain. The only system at the top of its class in price and performance.

System Specifications

CPU	Microprocessors	Twin Z80A's with 4MHz Clock Frequency. One Z80A (the host processor) performs all processor and screen related functions. The second Z80A is "down-loaded" by the host to execute disk I/O. When not processing disk data, the second Z80 may be programmed by the host for other processor related functions.
	Word Size	8 bits
	Execution Time	1.0 microseconds register to register
	Machine Instructions	158
	Interrupt Mode	All interrupts are vectored.
Floppy Disk	Storage Capacity	285K total bytes formatted on two double density drives. Optional external 10-300 megabyte hard disk storage is available using optional S-100 bus adaptor.
	Data Transfer Rate	250K bits/second
	Average Access Time	250 milliseconds, 35 milliseconds track-to-track
	Media	5 1/4 inch mini-disk
	Disk Rotation	300 RPM
Internal Memory	Dynamic RAM	64K bytes dynamic RAM
	Static RAM	256 bytes of static RAM is provided in addition to the main processor RAM. This memory is used for program and/or data storage for the auxiliary processor.
	ROM Storage	1K bytes standard. Allows ROM "bootstrapping" of system at power-on. ROM storage is 2708 compatible and may be reprogrammed by the user for custom applications.
CRT	Display Size	12-inch, dynamically focused P4 phosphor
	Display Format	25 lines x 80 characters per line
	Character Font	8 x 8 character matrix on a 8 x 12 character field
	Line Drawing Characters	Eleven special graphics symbols used for form generation.
	Display Presentation	Light characters on a dark background. Reversible through keyboard/program selection.
	Bandwidth	20 MHz.
	Cursor	Reversed image (block cursor)
Communications	Screen Data Transfer	Memory-mapped at 38 kilobaud. Serial transmission of data at rates up to 9600 bps.
	Auxiliary Interface	Universal RS-232 asynchronous. Synchronous interface optional.
	Parallel Interface	Radio Shack TRS-80 compatible.
	S-100 Bus	Printed circuit edge connector provided for connection of optional S-100 bus adaptor.
	Transparent Mode	Enables display of all incoming and outgoing control codes.
	Parity	Choice of even, odd, marking, or spacing.
	Transmission Mode	Half or Full Duplex. One or two stop bits.
	Addressable Cursor	Direct positioning by either discrete or absolute addressing.
System Utilities	Disk Operating System	CP/M
	DOS Software	An 8080 disk assembler, debugger, text editor and file handling utilities.
Optional Software	FORTRAN	ANSI standard. Relocatable, random and sequential disk access.
	COBOL	ANSI standard. Relocatable, sequential, relative and indexed disk access.
	BASIC	Sequential and random disk access. Full string manipulation, interpreter.
	Application Packages	Extensive software development tools are available including software for the following applications: Payroll, Accounts Receivable, Accounts Payable, Inventory Control, General Ledger and Word Processing.
Keyboard	Alphanumeric Character	Generates all 128 upper and lower case ASCII characters.
	Special Features	N-Key Rollover, Automatic repeat (at 15 CPS), Keyboard lock/unlock.
	Numeric Pad	0-9, decimal point, comma, minus and four user-programmable function keys.
	Special Functions Keys	Up to 64 user-defined two-key function sequences.
	Cursor Control	Up, down, forward, backward, and home.
Internal Construction	Cabinetry	Structural foam
	Component Layout	Two board modular design. All processor related functions and hardware are on a single printed circuit board. All video and power related circuits on a separate single board. These two boards are interconnected via a single 22-pin ribbon cable.
Mounting		CRT and two circuit boards mounted to base. CRT in a rigid steel frame. Disk Drive assembly mounted into upper cover for ease of servicing.
Environment	Weight	Approximately 45 pounds
	Physical Dimensions	14 3/8" (H) x 21 1/2" (W) x 23 1/2" (D)
	Environment	Operating: 0° to 50° C Storage: 0° to 85° C, 10 to 95% rel. humidity - non condensing.
	Power Requirements	115 VAC, 60 HZ, 1 AMP (optional 230VAC/50HZ model available)

*Specifications subject to change without notice

DEALER/OEM QUANTITIES AND SPECIAL PRICING AVAILABLE VIA MICROAMERICA DISTRIBUTING



NEECO

679 Highland Ave.
Needham, MA
02194

Mon-Fri 9:30-5:30
MasterCharge &
Visa Accepted

(617) 449-1760

Telex: 951021

Microcomputer Systems Division

MICROAMERICA DISTRIBUTING

"SuperBrain Dealer/O.E.M. Inquiries invited"

21 Putnam Street
Needham, MA
02194

(617) 449-4310

Circle 72 on inquiry card.



Photo 1: The Terak microcomputer with dual floppy-disk drive, video display, and keyboard. The Summagraphics Bit Pad consists of the digitizing tablet and the microcomputer control unit.

required for the strain wave to reach the receive coil, and this delay is used to calculate X and Y coordinate data.

Digitizing Tablet

The data tablet is a low-profile, plastic pad that has an active surface area of approximately 784 square centimeters. The X,Y origin is located in the lower left corner of the tablet and is not relocatable. The active surface area can be visualized as a square matrix of 2795 by 2795 points with a resolution of 0.1 mm. The Bit Pad can also be configured for English unit measurements.

Microcomputer Control Unit

The control unit contains six front-panel, push-button switches (see photo 1). One is a reset switch, three switches control the digitizing rate, and two switches control the operating mode. These switches may be overridden by software from the host processor, thus allowing complete

host control.

The three rate switches select 64, 32, 16, 8, 4, 2, or 1 coordinate pairs to be generated per second. The two mode switches select point, switch-stream, or stream operating mode.

A coordinate pair is generated for each depression of the Z-axis switch in the stylus or cursor in the *point* mode. In the *switch-stream* mode, coordinate pairs are generated continuously as long as the Z-axis switch remains depressed. Coordinate points are generated continuously in the *stream* mode. It should be noted that no points are generated unless the stylus or cursor is within 4 mm of the active surface area of the tablet.

The control unit also contains an 8-bit input and output (I/O) port, an interrupt line, a single-bit reset line, and optionally a TTL or RS-232C serial line. The input port (also referred to as the command byte, figure 1) allows for control of both the operating mode and transmission rate of

the Bit Pad by a host processor. Three bits are allocated for the transmission rate, two bits for the operating mode and three bits serve as hand-shaking signals between the host processor and the Bit Pad.

The three handshaking bits are: *status valid*, which is used by the host computer to signal a change in mode or rate; *byte received*, which indicates that a byte of data has been read by the host; and *next byte*, which is used by the host to request the next byte of data from the Bit Pad. An additional single-bit line (*in strobe*) enables the host to reset the Bit Pad's control unit.

A host processor can receive data from the Bit Pad by polling or handshaking, or the Bit Pad interface can be driven by interrupts. The output port of the Bit Pad provides coordinate points to the host processor in a sequence of five data bytes (see figure 2). A 1 in the most significant bit of the first byte signals the host

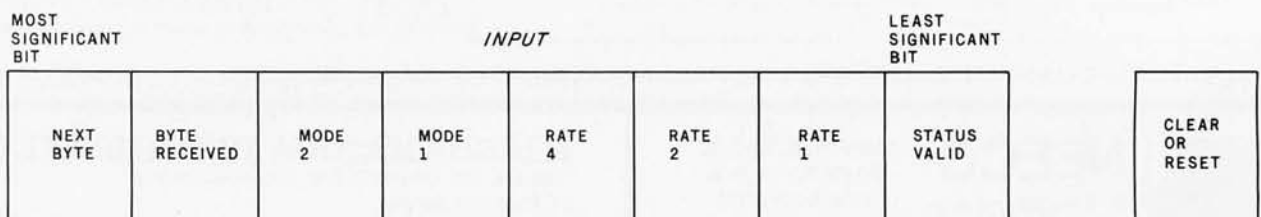

Figure 1: The bit format of the input or command byte for the Bit Pad. In addition, a single line is used by the host computer to reset or clear the Bit Pad's electronic circuitry.

DELTA IS READY . . .

Call For
DEALER
In Your Area

Z-80 CPU



Two serial ports, three parallel ports. 2/4 MHz, on board Prom Monitor Phantoms. (Less cable and Monitor). A & T \$325.00

DOUBLE/SINGLE DISK CONTROLLER



Two stage phase lock loop circuitry for greatest reliability, data transfer at maximum rate. Transparent density selection. 8" or 5" operation 2 or 4 MHz (Some restrictions on DMA).
DMA — \$425.00
STD. — \$385.00

16K, 32K STATIC RAM



World's most reliable memory, responds to extended address lines A16, A17, cool running, fast.
16K-\$395.00 32K-\$650.00

32K, 48K, 64K DYNAMIC RAM



Basic dynamic board tested to run at 4MHz with our Z-80 board. 4116 chips at 200 nanosecond speed insures most reliable data storage. Double density and DMA compatible.
32K-\$580.00 48K-\$640.00
64K-\$750.00

32K, 48K, 64K ERROR DETECTING Cromenco / Alfamicro

Available
March 1980

State of the art development. Parity generation and error detection. Compatible with 16 bit CPU designs. 16K bank, select under software control. 4MHz Z-80, 8086, Cromenco, Alpha Micro compatible.
32K-\$650.00 48K-\$725.00
64K-\$850.00

FLOPPYS



8" Shugart . . . \$750.00
8" Siemens . . . \$675.00
5" Seimans . . . \$350.00
(Double Sided)
8" CDC . . . \$875.00
8" Remex . . . \$825.00

TELEVIDEO 912



80 x 24—Lower case descenders. Teletype or typewriter keyboard 110/220 VAC. 50 to 19.2 Kbaud Hex entry pad. Similar to SOROC but better looking with NO FAN NOISE.

TELEVIDEO 920



Similar to TV 912 but has programmable functions keys across top. Excellent for WORDSTAR Text Editing.

WINCHESTER/SHUGART SA 1000



5 megs now expandable to 10, works alongside floppy disk drive for expanded storage. Use with controller below.
\$1950.00

WINCHESTER/CENTURY DATA SYSTEM (Hunter Shown)



20 megs expandable to 40—Marksman series, plugs into our CPU parallel port or MP/M board drive, cabinet, power supply, 2.0 Bios.
\$4850.00

FLOPPY DISKS

D Y S A N Quality



8" SSSD . . . \$4.25
8" SSDD . . . \$5.50
8" DSDD . . . \$7.60
5" SDD . . . \$4.10
(Boxes of 10 only)

MPM I/O TIMER

Available
March 1980

Designed for MP/M® software of Digital Research. 6 users serial port, three 8 bit parallel ports for hard disk. Timer and vectored interrupt.
©TM Digital Research

80 x 24 VIDEO

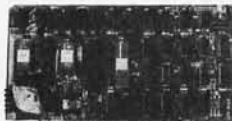

Keyboard input, Z-80 Processor, on board RAM makes this a non-memory mapped substitute for a terminal when mated with a keyboard.
\$430.00

WINCHESTER/FLOPPY INTERFACE

Available
March 1980

Allows mixing of Shugart Winchester and floppy drives on same cable when used with DP-DSK. Supplied with software Bios for MP/M® and 2.0
©TM Digital Research

CABLES/PROMS

2718 Monitor . . . \$25.00
2716 Monitor . . . \$50.00
Disk 50 Pin . . . \$22.00
RS-232 . . . \$15.00
CPU to Back . . . \$32.00
Disk DC . . . \$ 4.50
Disk AC . . . \$ 2.50
Winchester . . . \$28.00

DP S-100 Main Frame



- 12 slot S-100 Motherboard (6 populated)
 - +8V @ 20A ±16V @ 6A. (Nylon card guides).
 - Mates with disk system shown in center column.
 - 3 user convenience outlets at rear.
 - Status indicators for I/O wait, memory error, voltage levels.
 - Multi-user capable with circuit board selection at top.
- Kit (less fans) \$295.00 A & T \$450.00

Disk Drive Storage



- Cabinet comes with multiple power.
 - Supply to suit all popular disk drives ±5A, +24 @ 6A.
 - DP-1000K Twin double density Shugart SA-800B or Siemens FDD-100-8 (1 megabyte). \$1800.00
 - DP-2000K Double sided, double density Shugart SA-850-R or Siemens FDD-200-8 (2 megabytes). \$2450.00
 - Drive box less drives with ample power supply.
- Kit (less fans) \$295.00 A & T \$450.00

NORTH STAR Competitor



- Cost effective Z-80 dual drive micro system.
 - Double density Siemens drives sport 340K single sided, 680K double sided.
 - 32K RAM standard, expandable to 64K.
 - CPM 2.0 software included.
- \$2450.00

West:

DELTA PRODUCTS

1653 E. 28th Street
Long Beach, Calif. 90806
Tel: (213) 595-7505
Circle 73 on inquiry card.



Telex: 182-126 DELTMAR SGHL

East:

DELTA PRODUCTS

11 Edison Drive
New Lenox, Illinois 60451
Tel: (815) 485-9072

	MOST SIGNIFICANT BIT		OUTPUT						LEAST SIGNIFICANT BIT	
BYTE 1	FIRST BYTE	BYTE AVAILABLE	F3	F2	F1	F0	0	0		
BYTE 2	FIRST BYTE	BYTE AVAILABLE	X5	X4	X3	X2	X1	X0		
BYTE 3	FIRST BYTE	BYTE AVAILABLE	X11	X10	X9	X8	X7	X6		
BYTE 4	FIRST BYTE	BYTE AVAILABLE	Y5	Y4	Y3	Y2	Y1	Y0		
BYTE 5	FIRST BYTE	BYTE AVAILABLE	Y11	Y10	Y9	Y8	Y7	Y6		

Figure 2: Five bytes of data are transmitted from the Bit Pad's output port for each coordinate pair of points generated. The first byte contains information concerning depression of the Z-axis switch. The next four bytes contain a 12-bit representation of the X and Y coordinates. Each byte also contains two control bits, which are used for handshaking purposes.

that the current byte is the first of the five-byte sequence. The next bit (*byte available*) when set to 1 indicates that a byte of data is available, and the bit labeled F0 corresponds to the status of the Z-axis switch.

An optional four-button cursor may also be used. The four buttons correspond to bits F0 thru F3 in byte 1. The next four bytes in the sequence contain a 12-bit representation of the X and Y coordinates. This data can also be transmitted in serial format with parity and stop bits, at data transmission rates from 37.5 bps to 28,000 bps.

The control unit does not contain a pilot light; however, it does contain two diagnostic routines that can be used to check its circuits and interface connections to the host processor. The control unit requires power sup-

plies of +5 V and +12 V, and -12 V or, with optional regulators, +8 V, +16 V, and -16 V.

Pascal Program: PLANIMETER

This program, which appears in listing 1, receives coordinates points five bytes at a time from the Bit Pad. The line length and area of a closed two-dimensional figure are calculated by integrating the figure with trapezoids. By using Pascal and the Terak, it is possible to receive and process approximately thirty coordinate points per second.

User-defined data types are used to interface the Bit Pad to the Terak minicomputer. LOWBYTE is the image of the output from the Bit Pad. It contains three fields: the data (D), READY (*byte available*) and the FIRST-byte bits. DEVICE is a data-

type that represents the I/O buffers on the Terak's port which are connected to the Bit Pad.

At the beginning of the main program, the pointer BITPAD is set to the integer value -160 (which is the address of the port) using a variant record type. The pointer BITPAD.P points to the port, and BITPAD.P1 contains the Terak I/O buffers for the parallel port.

Each input byte is read as LOOKB := BITPAD.P1.INBUF in the procedure NEXTBYTE using handshaking. The sequence begins by waiting for the next byte to be ready (LOOKB.READY is true). The Terak signals the Bit Pad that it has read the data by sending the command byte OUTRECEIVED. The program increments the counter (BYT), waits for the Bit Pad to clear and then signals

GIVE YOUR COMPUTER A HAND

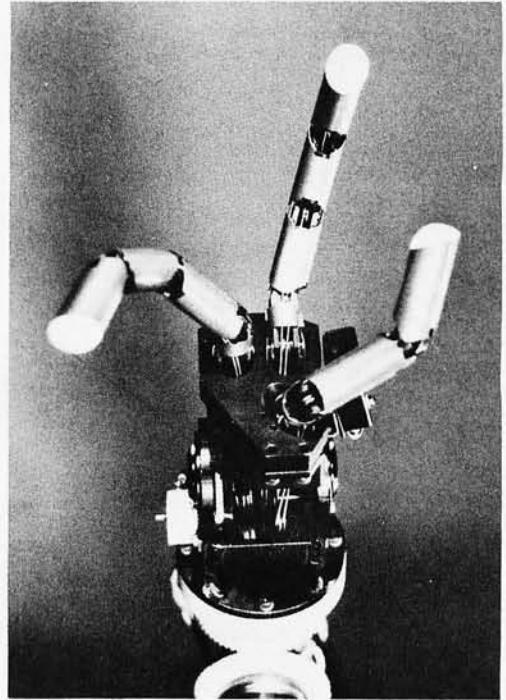

Have you ever wanted to do more with your micro than play computer games and balance your checkbook?

Finally, there is a unique new quarterly magazine that gives you all the information you need to transform your home computer into a working **ROBOT!**

ROBOTICS AGE covers every aspect of robot research and experimentation—from the basic principles to the latest developments in laboratories around the world. In our features, special emphasis is given to plans, circuits, and programs that you can use in your own microcomputer-controlled robot. Each article is designed to be understandable to the novice experimenter, but with technical detail and complete references that will satisfy even the

professional researcher. Added to that are robotics-related New Products, Book Reviews, abstracts of selected recent technical papers, and reports on how you can participate in the growing number of robotics and Artificial Intelligence organizations in the US and abroad.

The explosive growth in the use of robots has been described as the Third Industrial Revolution. Robots are having a growing impact on the shape of industrial society—and will be a significant part of your own future. Join the thousands of ROBOTICS AGE readers already gaining a deeper understanding of this fascinating and significant science. Learn how you can contribute to the development of the intelligent robots of the future—*Subscribe Today!*

ROBOTICS AGE



ROBOTICS AGE

P. O. BOX 801 LA CANADA, CA 91011

1 year subscription (4 issues)—US: \$8.50; Canada & Mexico: \$10.00; Foreign: \$12.00†

2 years (8 issues) US: \$16.00; Canada & Mexico: \$19.00; Foreign: \$23.00†

Payment enclosed Bill my VISA MasterCard Bill me (N. America only)

Number

Expires

Signature (Required)

Name (Please Print)

Company/Title

Street Address/Apt. No.

City

State/Country

Postal Code

† Rates shown are for surface delivery. Air mail delivery available at extra cost. Please remit in US funds drawn on a US bank.

```

PROGRAM PLANIMETER;
(* Written by: John Fryhofer

and modified by Greg Hansen.

This program reads parallel data from a digitizing tablet and calculates
the area and perimeter of a closed figure traced on it *)

CONST
PORTADDR = -160;
OUTRECEIVED = 95 (* 01011111 *);
OUTNEXT = 159(* 10011111 *);
MINPTS = 13;

TYPE
(* Output from BIT PAD *)
LOWBYTE = PACKED RECORD
D : 0..63 ;
READY : BOOLEAN;
FIRST : BOOLEAN
END;
(* this is what the device looks like *)
DEVICE = PACKED RECORD
CSR : PACKED ARRAY [0..15] OF BOOLEAN;
OUTBUF : INTEGER;
INBUF : LOWBYTE;
END;

VAR
BITPAD : RECORD (* Loads the device address as an integer and
points to it *)
CASE BOOLEAN OF
FALSE : (P : ↑DEVICE);
TRUE : (I : INTEGER)
END;

CALCDELTA, CLOSEDELTA, BYT, P : INTEGER;
LOOKB: LOWBYTE;
RESPONS: CHAR;
START, (* Start new figure *)
DIDPRINT: (* Already printed for button up *)
BOOLEAN;
FIRSTX, FIRSTY, LASTX, LASTY, X, Y,
AREA, LEN, CUMAREA, CUMLEN, MAGR: REAL;
K: PACKED ARRAY [0..1] OF CHAR; (* Dummy array; K[0] holds command *)
PTR : INTERACTIVE;

PROCEDURE NEXTBYTE;
VAR W: LOWBYTE;
BEGIN (* Reads next byte from BIT PAD *)
REPEAT
IF NOT UNITBUSY(2) THEN UNITREAD (2,K[0],1,1); (* Look for command *)
LOOKB := BITPAD.P↑.INBUF
UNTIL LOOKB.READY OR (K[0] = 'Q'); (* Good data *)
BITPAD.P↑.OUTBUF := OUTRECEIVED;

IF LOOKB.FIRST THEN BYT := 0;
BYT := BYT + 1;

REPEAT
W := BITPAD.P↑.INBUF
UNTIL NOT W.READY; (* BIT PAD reset *)
BITPAD.P↑.OUTBUF := OUTNEXT; (* BIT PAD sends next byte *)
END (* NEXTBYTE *);

PROCEDURE DEBUG;
(* used for debugging only *)
BEGIN
WRITE(LOOKB.D);
IF LOOKB.READY THEN WRITE(' READY');
IF LOOKB.FIRST THEN WRITE(' FIRST');
Writeln;
END;

PROCEDURE PRINT;
(* Print results *)
BEGIN
Writeln ('# Points :', P:5, ' / Area :', SQR(MAGR)*ABS(CUMAREA):9:6,
'sq mm / Lensth :', MAGR*CUMLEN:9:6, ' mm');
IF (K[0] = 'P') AND (P <> 0) THEN
WRITE (PTR, '# Points :', P:5, ' / Area :', SQR(MAGR)*ABS(CUMAREA):9:6,
'sq mm / Lensth :', MAGR*CUMLEN:9:6, ' mm', CHR(10));
END; (* PRINT *)

PROCEDURE NEWFIGURE;
BEGIN (* initialize *)
START := FALSE;
FIRSTX := X;
FIRSTY := Y;
LASTX := X;
LASTY := Y;
P := 0;
CUMAREA := 0;
CUMLEN := 0;
WRITE ('*DOWN', CHR(7));

```

Listing 1: Pascal program that uses input from the Summagraphics Bit Pad and determines the area perimeter of a traced figure.

the Bit Pad with OUTNEXT that the next byte is ready to be received.

The first loop in the main program waits for the depression of the cursor Z-axis switch ("button down" in the listing). The loop also synchronizes the program with the five data bytes from the Bit Pad. Only the first byte of the five-byte sequence contains a 1 in bit 7 (FIRST is TRUE), and a 1 in bit 2 (D = 4) when the switch is depressed. Bit 6 is set to 1 (READY is TRUE) by the Bit Pad when the byte is available. When the switch is released the results are displayed using the procedure PRINT.

The second loop is executed for each point when the switch is depressed and coordinates are being received. Bits 0 thru 5 (D) of input bytes 2 and 3 contain the 12-bit X coordinate and D in bytes 4 and 5 contain the Y coordinate. After each byte is fetched, the CASE-statement code transfers the data into the integers X and Y by adding up the values. When the final byte is taken, it may then start a new figure if the switch was just pushed, calculate the next point, and/or detect closure and print the results.

The procedure CALC is called after each X,Y coordinate input that is located at a distance at least CALCDELTA away from the last point. X and Y are the integer coordinates in units of the Bit Pad's increments, which are 0.1 mm from the tablet's origin (lower left corner). The maximum value possible for X and Y is 2795. The length is calculated with the formula for the distance (d) between two points:

$$(d) = \sqrt{(X1 - X0)^2 + (Y1 - Y0)^2}$$

where X1 and Y1 are the current coordinates and X0 and Y0 are the last coordinates. Since many points are processed, the length of an irregular line is calculated from a number of short straight lines that yield a good approximation of the true line length.

Listing 1 continued on page 122

TBS-80 DATA PROCESSING SYSTEMS. ONE STEP BEYOND.

If you thought the TRS-80™ microcomputer was just a toy, think again. These **TBS-80** software systems will turn that computer into a **powerful data processor**.

INFORMATION SYSTEM by Dale Kubler is simply the best in-memory, data base manager on the market. It allows you to create files with up to ten fields per record, up to 40 characters per field and 200 characters total per record. Data from the keyboard is entered directly onto a screen display of one entire file.

Once entered, you can sort or search your entire data base by any category and have the information desired displayed on the screen. **INFORMATION SYSTEM** provides a thorough editing mode allowing changes by line without rewriting an entire file. This program allows you to program your own printouts to almost any form you desire for line or serial printers. Screen prints from anywhere in the program are also available.

INFORMATION SYSTEM creates either disk or cassette files depending upon the version you use. From mail lists to recipes, this program is the ideal small system information manager. The price for this program, 32K up disk is \$34.50. For systems 16K up tape it's \$24.50.

DATA MANAGER by Dale Kubler starts out where **INFORMATION SYSTEM** leaves off. Requiring 32K and one disk, it accepts up to ten user-defined fields with up to forty characters per field and 255 characters per record. As with all TBS software, data entry and editing is professional and simple to use. What makes this program stand apart from "in-mem" data managers is that it uses up to four disks on line as memory, or as much as 320K of memory storage. Because disk sorts take more time than in-mem sorts, **DATA MANAGER** enables the user to create and maintain up to 5 "key" sort files for quick access of data. A utility program is provided to calculate the number of records possible since the amount of records you can maintain is dependent on a number of variables. This program also supports the upper/lower case modification, and printouts can be programmed to almost any format and sent to line or serial printer. Background printing is provided enabling the computer to search and print at the same time. If you already have **INFORMATION SYSTEM**, **DATA MANAGER** will accept those files. A necessity for organized people, this program sells for \$49.50.

BUSINESS MAIL SYSTEM by Dale Kubler is designed for large-scale business users. Requiring 32K, two disks and printer, this program will store up to 150,000 names in a single file spread out over multiple disks. Each data disk holds 500 names. After data entry, **BMS** automatically sorts the data by zip code and alphabetical order within the zip code. The program tells you when and which data disk to insert, expanding your files automatically until you've reached 300 disks. Data is input directly onto formatted screen display with the option to use Company Name/Attention instead of Last Name/First Name. Three numeric and one alpha code fields are provided to help you use the search and printout mode. **BUSINESS MAIL SYSTEM** allows you to

™ TRS-80 is a trademark of the Tandy Corporation.



program the number and spacing of your labels. With more features than can be described here, this high-powered program sells for \$125.00.

TEXT MERGE is the program that puts it all together. If you have the **ELECTRIC PENCIL** from Michael Shroyer, 32K and one disk drive, then this program is a must. It will merge your data base from any of the above programs with an Electric Pencil file. For example, when you write a letter that is going to several hundred people, you can "code" it by entering a field name from the above programs in place of the actual information. Then, when **TEXT MERGE** is run, it will print out your Pencil file and substitute the "code" with the actual data. In other words, you can print out 1,000 personalized letters without stopping the computer. This program will also enable you to selectively search out only the records from your data base that you wish to use. Also included is the ability to set left, right, top and bottom margins, set page numbers anywhere on the page, and print out right justified if you so choose. **TEXT MERGE** will turn your computer into a powerful data processor and it sells on disk for \$49.50.

TBS has other incredible software for Tandy's microcomputer. Intent on making it a powerful tool, we have **large scale business accounting systems, general accounting systems, system utilities and the Library 100**. We have the only **DISK HEAD CLEANER** (for APPLE too!) and **GRAN MASTER DISKETTES**, the best on the market.

TBS is **YOUR COMPANY**, and we build systems, not just software. The above products are available now, nationwide. Visit your local Computer Dealer or Associate Radio Shack Store and demand the best, demand TBS. For more information, contact us through the numbers below.



THE BOTTOM SHELF, INC.
(404)939-6031 • P.O. Box 49014 • Atlanta, GA 30359

Listing 1 continued:

```

END; (*NEWFIGURE*)

PROCEDURE CALC;
BEGIN
    P:= P + 1;
    AREA:= (X - LASTX) * (Y + LASTY) / 2 / 100;
    LEN:= SQRT(SQR(LASTX-X) + SQR(LASTY-Y)) / 10;
    CUMAREA:= CUMAREA + AREA;
    CUMLEN:= CUMLEN + LEN;
    IF KC0J = 'A' THEN (* Print each point *)
        PRINT;
    LASTX:= X; (* Save this point *)
    LASTY:= Y
END; (* CALC *)

PROCEDURE CLOSURE;
BEGIN
    (* back at first point! finish *)
    CUMAREA:= CUMAREA + (FIRSTX - LASTX)*(FIRSTY + LASTY) / 2 / 100;
    CUMLEN:= CUMLEN + SQRT(SQR(LASTX-FIRSTX) + SQR(LASTY-FIRSTY)) / 10;
    Writeln ('*CLOSURE', CHR(7));
    PRINT;
    DIDPRINT:= TRUE;
    START := TRUE;
END;

BEGIN (* MAIN *)
    REWRITE(PTR,'REMOTE:');
    BITPAD.I := PORTADDR;
    BITPAD.Pf,OUTBUF := OUTNEXT;
    Writeln(' LENGTH AND AREA MEASUREMENTS');
    Writeln;
    Writeln('Please leave all the switches out. The program sets the BIT PAD to');
    Writeln(' stream mode and full speed. ');
    Writeln;
    Writeln('Type a "Q" at any time to change magnification or quit. ');
    Writeln;
    Writeln(' "A" to see all the points displayed ( with speed degradation ); ');
    Writeln(' "P" to turn on the printer. ');
    Writeln(' and press a space to turn off the modes. ');
    REPEAT
        KC0J := ' ';
        Writeln;
        WRITE('CALCDELTA: ');
        READLN(CALCDELTA);
        WRITE('CLOSEDELTA: ');
        READLN(CLOSEDELTA);
        WRITE('MAGNIFICATION FACTOR? ');
        READLN (MAGR);
        Writeln ('READY. FACTOR = ', MAGR :9:7);
        START := TRUE;
        DIDPRINT := TRUE;

        WHILE KC0J <> 'Q' DO
            BEGIN
                (* Loop for each point *)

                REPEAT
                    (* Wait for button down *)
                    NEXTBYTE;
                    IF (BYT = 1) AND (LOOKB.D <> 4) AND NOT DIDPRINT THEN
                        BEGIN
                            (* If first point and button up *)
                            Writeln('*UP', CHR(7));
                            PRINT;
                            DIDPRINT:= TRUE;
                            START := TRUE
                        END
                    (* If first point and button up *)
                UNTIL (BYT = 1) AND (LOOKB.D = 4) OR (KC0J = 'Q');
                (* Button is down *)
                WHILE (BYT < 5) AND (KC0J <> 'Q') DO
                    BEGIN (* Get whole point *)
                        NEXTBYTE;
                        DIDPRINT:= FALSE;
                        CASE BYT OF
                            2: X := LOOKB.D;
                            3: X := X + 64*LOOKB.D;
                            4: Y := LOOKB.D;
                            5: BEGIN
                                Y := Y + 64*LOOKB.D;
                                IF START THEN
                                    NEWFIGURE
                                ELSE IF (ABS(X - LASTX) > CALCDELTA) OR
                                    (ABS(Y - LASTY) > CALCDELTA) THEN
                                    CALC; (* Only take points far enough away *)
                                IF (ABS(X-FIRSTX) < CLOSEDELTA) AND
                                    (ABS(Y-FIRSTY) < CLOSEDELTA) AND (P > NJNPTS) THEN
                                    CLOSURE; (* Back at first point +/- DELTA *)
                                END(* 5: *)
                            END; (* CASE *)
                        END; (* Get whole point *)

                    END; (* Next point *)
                    WRITE ('ANOTHER MEASUREMENT? ');
                    READ(RESPONS);
                    UNTIL RESPONS = 'N';
                END.
            END.
    END.

```

Area Calculation

Area is calculated by integration, by dividing the figure being traced into trapezoids. The trapezoids are calculated with the X axis as the base and up to the present and last points as the top. This formula is calculated for each new point:

$$\text{Area} = [(X_1 - X_0) \times (Y_1 + Y_0)] / 2.$$

When the current point is within a distance equal to CLOSEDELTA of the first point, closure is detected. This is done in order to achieve the lowest possible error by ending the figure where it started (ie: within 0.3 mm of the beginning of the trace). When closure is detected, final calculations are made to close the figure. The results are printed, and START is set so it will clear the variables the next time around for a new figure.

CALCDELTA is used to correct for oscillation of the coordinates due to the analog-to-digital (A/D) conversion, which results in inaccurately measured line lengths. If CALCDELTA is too small, then oscillation between points causes many coordinates to be inappropriately summed resulting in an overestimation of the true length of the traced figure. If CALCDELTA is too large, not enough points will be fitted, resulting in a less accurate approximation. Good results have been obtained with CALCDELTA = 3 (that is, 0.3 mm).

Conclusion

This electronic planimeter has been used for thousands of measurements in a laboratory environment. It is faster to use and more accurate than a mechanical planimeter. The relative error between twenty repeated area-tracings of several different figures was consistently less than 0.5%. This electronic planimeter is less expensive and more flexible than commercially available dedicated-microprocessor systems that are specifically designed for planimetry, such as the Leitz Image Analysis System and the Zeiss MOP-3. A microcomputer or mini-computer user whose application involves length and area calculations of irregularly shaped figures will find this system useful and relatively inexpensive to construct. ■

DUMMM

people don't read our ads....

Part No.	Description	Price	
VDS-M	8-slot Mainframe with room for 2 8" floppies	800.00	New
VDS-IIM	8-slot Mainframe with 2 8" floppies & FDI-ASM	2488.00	New
VDS-IIMD	8-slot Mainframe with 2 8" floppies & DD-ASM	2599.00	New
MEM-32K-ASM	Tarbell 32k Static Memory for S-100 bus	725.00	
MEM-16K-ASM	Tarbell 16k Static Memory for S-100 bus (Memories only come assembled & checked out)	440.00	
CI-ASM	Cassette Interface Assembled & Checked out	175.00	
CI-KIT	Cassette Interface Kit (now incl software)	120.00	
FDI-ASM	Floppy Disk Interface Assembled & Checked out	325.00	Inc
FDI-KIT	Floppy Disk Interface Kit	225.00	Inc
DD-ASM	Double Density Floppy Disk Interface A&T	425.00	
DD-KIT	Double Density Floppy Disk Interface Kit	325.00	
VDS-II	Vertical Disk Subsystem	1888.00	
VDS-IID	Double Density Disk Subsystem	1999.00	
PS270	PerSci Model 270 Dual Floppy Disk Drive	1295.00	
SIM120	Siemens Model 120-8 Single Floppy Disk Drive	495.00	
SHU800	Shugart 800/801 Floppy Disk Drive	525.00	
CP272	Power Supply for PerSci 270 Dual Drive	125.00	
CP206	Power Supply for PerSci 299	120.00	
CP206	Power Supply for Two Siemens or Shugart	120.00	
MPM	Digital Research Multi-User OS with our I/O	400.00	New
DB-1	Tarbell Database Software (minimal support)	25.00	New
TBAS-CAS	Tarbell Cassette BASIC on cassette incl manual	72.00	Inc
TBAS-DSK	Tarbell Disk BASIC on CP/M disk incl manual	72.00	Inc
	Note: the following two items can only be ordered with Tarbell Disk or Cassette BASIC:		
TBAS-LST	Tarbell BASIC source listing on paper	36.00	Inc
TBAS-SRC	Tarbell BASIC source on 2 CP/M disks	36.00	Inc
PTSW+LST	Proc Tech Assembler/Editor with listing	15.00	
EMPL-CAS	EMPL micro APL on cassette & instructions	15.00	
EMPL-DSK	EMPL micro APL on CP/M disk & instructions	20.00	
CPM-2.0	CP/M 2.0 Operating system incl documentation	150.00	
CPM-1.4	CP/M 1.4 Operating system incl BASIC-E on disk	70.00	
CPM-1.4-M	CP/M 1.4 on soft-sectored MINI-FLOPPY disk	70.00	
CPM-MS	CP/M 1.4 Operating system manual set (of six)	25.00	
BASE-MAN	BASIC-E Compiler Manual (works with CP/M)	5.00	
BASE-LST	BASIC-E Source Listing (in PL/M)	15.00	
PBLC-DMN-1	Public Domain Disk #1 - includes DISKTEST, BASIC-E, CBIOS, FORMAT, TAPELIB, etc on disk	10.00	
PBLC-DMN-2	Public Domain Disk #2 - includes Double Density FORMAT, DISKTEST, Auto-BIOS for 1.4 & 2.0; FORTH	15.00	
CBAS-DSK	CBASIC-2 disk	85.00	
CBAS-MAN	CBASIC-2 manual	15.00	
SPLR	KLH Systems Spooler for CP/M on disk	70.00	
FAST	FAST! Screen-oriented Editor/Assembler for CP/M	100.00	
TELE-COM	Software to operate D.C. Hayes Modem Remote	195.00	
POLYVUE	Screen-Oriented CP/M Editor	135.00	
PASCAL/MT	Meta-Tech Pascal Compiler for CP/M	99.95	

Prices are subject to change without notice.
 California residents please add 6% sales tax.
 For quick delivery, see your local Tarbell dealer.

CP/M is a trademark/tradename of Digital Research



950 DOVLEN PLACE • SUITE B • CARSON, CALIFORNIA 90746
 (213) 538-4251 • (213) 538-2254

HARDWARE

SOFTWARE

MORE COLOR. MORE SOUND. MORE PERSONAL/BUSINESS POWER.



Compare the built-in features of leading microcomputers with the Atari personal computers. And go ahead, compare apples and oranges. Their most expensive against our least expensive: the ATARI® 400™.

Start with graphics capabilities. The ATARI 400 offers 128 color variations. 16 colors in 8 luminance levels. Plus 29 keystroke graphics symbols and 8 graphics modes. All controlled from a full 57 key ASCII keyboard. With upper and lower case. And the system is FCC approved with a built-in RF modulator. That's just for openers.

Now, compare sound capabilities. Four separate sound channels and a built-in speaker. With the optional audio/digital recorder, you can add Atari's unique Talk & Teach™ Educational System cassettes.

Here's the clincher: Solid state (ROM) software. For home management, business and entertainment. Or just plug in an Atari 10K BASIC or Assembler language cartridge and the full power of the computer is in your hands.

Memory? 8K expandable to 16K. And that's just for the ATARI 400 at a suggested retail of only \$549.99.

The ATARI® 800™ gives you all that and much more.

User-installable memory to 48K. A full-stroke keyboard.

With a high-speed serial I/O port that allows you to add a whole family of smart peripherals. Including up to four individually accessible disk drives. And a high speed dot-matrix impact printer. And, the Atari Program Recorder is included with the 800 system. Suggested retail price for the ATARI 800 (including recorder) is \$999.99.

Make your own comparison wherever personal computers are sold.

Or, send for a free chart that compares the built-in features of the ATARI 400 and 800 to other leading personal computers.

Atari promises to be the most popular Personal Computer System of the 1980's! Feel free to contact us for Atari literature.



NEECO

679 Highland Ave.
Needham, MA
02194

**Customer Sales:
NEECO**

679 Highland Ave., Needham, MA 02194
(617) 449-1760

Circle 77 on inquiry card.

Dealer Sales:

Microamerica Distributing

21 Putnum St., Needham, MA 02194
(617) 449-4310

Circle 72 on inquiry card.

**NEECO**

Microcomputer Systems Division

**PROUDLY ANNOUNCES THE NEWEST
HARDWARE AND SOFTWARE FOR YOUR PET!****The PET is now a truly sophisticated
Business System with the announcement
of these peripherals and software packages.****FREE
SOFTWARE
& PET DUST
COVER!**
*(Offer ends
2/28/80)***NEW
NEW****NEW**

PRODUCT	DESCRIPTION	PRICE	AVAILABILITY
PET 2001—8KN (Large Keys)	8K RAM	\$ 795	IMMEDIATE
PET 2001—8K	8K RAM	\$ 795	IMMEDIATE
PET 2001—16KN (Large Keys)	16K RAM*	\$ 995	IMMEDIATE
PET 2001—32KN (Large Keys)	32K RAM	\$1295	IMMEDIATE
PET 2023 PRINTER	ROLL FEED	\$ 695	IMMEDIATE
PET 2022 PRINTER	TRACTOR/ROLL	\$ 795	IMMEDIATE
ROMRETRO KIT	UPDATED O/S	\$ 90	IMMEDIATE
PET 2040	DUAL FLOPPY*	\$1295	IMMEDIATE
PET C2N	2nd Cassette	\$ 95	IMMEDIATE

*The 16K/32K (large keyboard) units do not include a cassette drive. Order C2N Cassette. 2040 Floppy Drive requires a 16K or 32K unit. 8K RAM Retrofit available July.

ALL PETS ARE FULLY TESTED BY NEECO BEFORE SHIPMENT. NEECO IS A FULL CUSTOMER-ORIENTED COMPANY. CALL FOR OUR FREE CATALOG. ALL ORDERS OVER \$795 WILL RECEIVE A FREE NEECO PET DUST COVER AND \$100 OF SOFTWARE FROM OUR CATALOG IF YOU MENTION YOU SAW THIS AD.

PET-DISK BASED BUSINESS SOFTWARE

SOFTWARE/APPLICATION	REQUIRES	AUTHOR	AVAILABILITY	PRICE
WORDPRO II / WORD PROCESSING	2040 + 16K PET	PRO/MICRO	IMMEDIATE	\$100
WORDPRO III / WORD PROCESSING	2040 + 32K PET	"	JANUARY	\$200
GENERAL LEDGER	"	CMS SOFTWARE	IMMEDIATE	\$295*
ACCOUNTS PAYABLE	"	"	JANUARY	\$295*
ACCOUNTS RECEIVABLE	"	"	JANUARY	\$295*
MAILING LIST	"	"	IMMEDIATE	\$100
MICROLEDGER	"	COMPUMAX	"	\$140
MICROPAY	"	"	"	\$140
MICROREC	"	"	"	\$140
MICROINV	"	"	"	\$140
MICROPERS	"	"	"	\$140

*The CMS Software (G/L, A/R, A/P) are based on Osborne & Associates trial tested business basic software. Software is complete with full documentation and user instructions. All packages require a printer for output. Commodore recommends the NEC Spinwriter (available from NEECO) as the output printer for WORDPRO.

PRODUCTS ARE AVAILABLE TO DEALERS VIA MICROAMERICA DISTRIBUTING (617-449-4310)

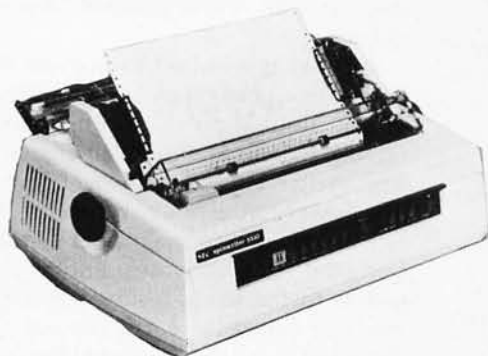
**FOR WORD PROCESSING
NEC IS BEST!**

- * 55 characters per second output speed
- * Changeable thimble for different typesizes
- * Less than 1% warranty malfunction rate
- * IBM quality letter output
- * Dealer inquiries invited

THE NEC SPINWRITER
MODEL 5530-P (Centronics I/O
modified for PET)

\$2995

*Price includes IEEE interface
to PET. IEEE Port is available
for use with 2040 Dual Disk.

*The NEC 5530-P is the output printer recommended by Commodore for their Word Processing System.

NEECO

679 Highland Ave.
Needham, MA
02194

Mon-Fri 9:30-5:30
MasterCharge &
Visa Accepted

(617) 449-1760
Telex: 951021

MICROAMERICA DISTRIBUTING

"Nationwide distributors of Computer Equipment"
21 Putnam Street
Needham, MA
02194

(617) 449-4310

A Power-Line Protection Circuit

Neil A Schneider
 Bror E Erickson
 9434 Ironwood
 Des Plaines IL 60016

Several years ago while he was working with color organ circuits, a friend of mine connected a color organ to an All American Five radio receiver. For those of you who are too young to remember, the All American Five was a popular five-tube radio design containing no power transformer. To my friend's surprise, and fortunately not to his harm, the connection of his color

organ to this radio resulted in foot-high flames as the audio output transformer burned.

The radio receiver had a "hot" internal chassis which was isolated from the outside world by its plastic case. The power cord was not polarized to connect the chassis to the low side of the AC power line. As my friend made his connection, he placed the 117 VAC power line current across the 8 ohm impedance audio-output secondary winding of the transformer, and across the speaker. This resulted in flames and a destroyed radio receiver.

Home computer enthusiasts of

today face the same problem. While my friend's error only resulted in the loss of a radio (about \$15), the connection of computer circuits to transformerless hot-chassis television sets can result in the loss of hundreds of dollars in digital circuits.

The obvious solution is to use three-wire power cords on all equipment to insure that the television chassis is at *earth ground*. This solution works fine as long as no wiring errors have been made in the AC power socket. If you transport your computer to a friend's house, you are again betting the hundreds of dollars, and maybe your life, on the accuracy of *his* electrical system.

The circuit shown in figure 1 is a better solution. This circuit is less expensive than an isolation transformer, and it can even incorporate a power-line fault indicator. The circuit simply detects ground-fault conditions. The 117 VAC relay connects between the cold-side power and earth-ground lines.

If a wiring error has been made, and the cold terminal is hot with respect to earth ground, the relay closes to *reverse* the power connection to the television. A neon lamp wired across the relay will provide a line-fault indication. **CAUTION!** No protection is provided with this circuit if the earth-ground line is defeated.

All that is required to provide full power-line protection is the addition of a double-pole, double-throw on/off switch as shown in figure 2. This switch is used to present reversible power to the relay. When the AC line is switched to the proper connection, the relay activates, and applies power to the load. If any attempt is made to defeat the earth ground, the circuit will not function, and the load will not receive power.

The result is a circuit that is, for most applications, less expensive and physically smaller than an isolation transformer. This relay circuit should fit inside almost any television set that you wish to modify for your video terminal. It may protect you and your equipment from a fatal mistake. ■

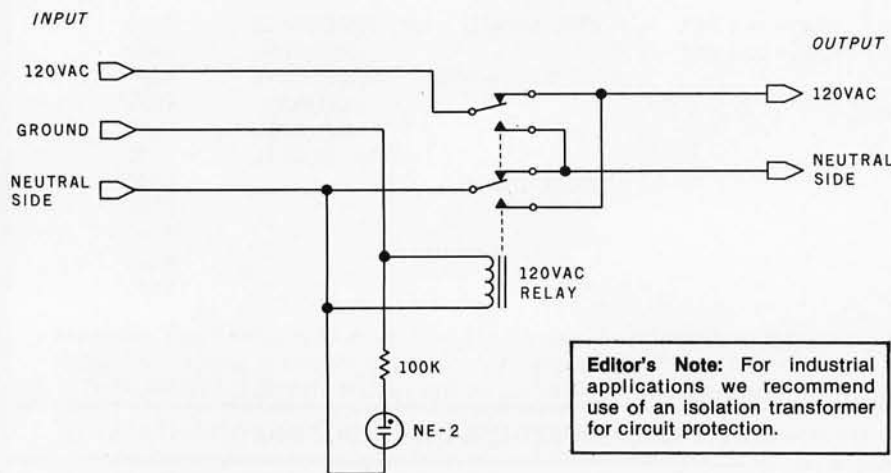

Figure 1: A simple circuit that offers some protection by using a relay to reverse connections to the power line. However, no protection is provided if the earth-ground line is defeated.

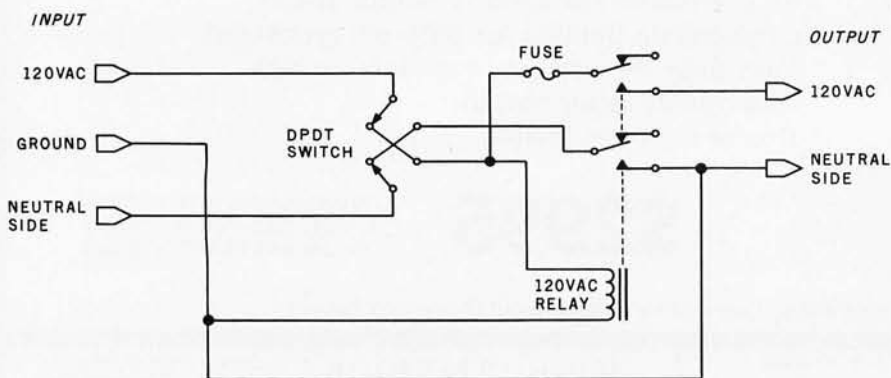
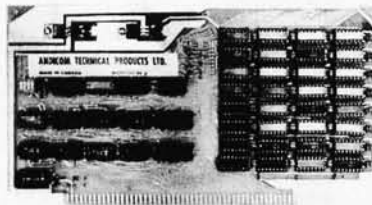

Figure 2: A better circuit that uses a double-pole, double-throw switch to present reversible power to the relay. If an attempt is made to defeat the earth ground, the power is cut off.

CANADIANS! NOW BUY IN CANADA AND SAVE 25% IN TAXES.

EXCELTRONIX proudly presents computer products, designed and manufactured in Canada by ANDICOM TECHNICAL PRODUCTS LTD.



ANDICOM DYNAMIC MEMORY BOARD

- S100 bus compatible
 - 4MHz operation guaranteed
 - Dip switch selectable boundaries
 - Designed to operate in Z-80 system
 - Temperature stressed for over 6 billion cycles
 - Full 12 month warranty
- | | | | |
|-----------|----------|-----------|----------|
| 16K | \$360.00 | 32K | \$450.00 |
| 48K | \$540.00 | 64K | \$630.00 |



ANDICOM FLOPPY CONTROLLER

- S100 bus compatible
 - IBM 3740 soft sectored compatible
 - Ability to control both 8" and 5" drives simultaneously under software control
 - Runs CPM on Shugart, Memorex, etc.
 - Single density
 - Software modification provided to run both 8" and 5" drives
- ASSEMBLED & TESTED \$255.00

ANDICOM A/D BOARD

- S100 bus compatible
 - 12 bit resolution
 - Maximum non-linearity, ± 0.2 count
 - Dual slope integrating A/D converter
 - Low Cost
 - May be expanded to 4 channels
- ASSEMBLED & TESTED \$125.00



TRS-80 A/D CONVERTER

- 12 bit resolution (with additional overrange and sign bits)
 - Dual slope integrating analog-to-digital converter
 - Input current: 1pA
 - Low noise: typical 15 micro-volt peak-to-peak
 - May be expanded to include up to 4 channels
 - Independent power supply
 - Software routines provided
 - Full 12 month warranty
 - Attractive, high impact plastic case
- ASSEMBLED & TESTED \$95.00

ANDICOM TRS A/D can turn your TRS machine into a useful laboratory-graded measurement instrument.

COMING SOON: High Gain Amplifier, Timer, D/A, and many others for TRS machines.

All boards are assembled and burnt in, using an industrial temperature controlled oven. They are also masked with solder resist and have gold contacts.

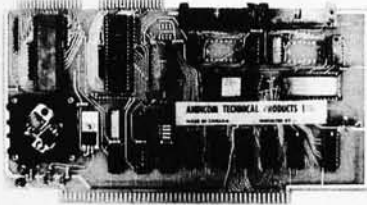

ANDICOM I/O BOARD

- S100 bus compatible
 - 2 serial RS232 compatible ports
 - 6 parallel ports (48 programmable I/O lines)
 - 6 interval timers (16 bit counters)
 - Software selectable BAUD rates
- ASSEMBLED & TESTED \$293.00

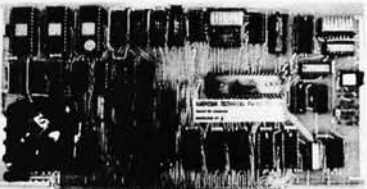

ANDICOM CPU-Z80A BOARD

- S100 bus compatible
 - 2K of on-board RAM
 - Space for up to 6K of EPROM
 - Power-on jump up to 256 addresses
 - 2 or 4 MHz operation
- ASSEMBLED & TESTED \$340.00

ANDICOM COLOR VIDEO GRAPHICS BOARD

- S100 bus compatible
 - Eight colors: green, yellow, blue, red, buff, cyan, magenta and orange
 - 11 programmable modes
 - 1 alphanumeric mode with 32X16 characters with inverse video
 - 2 semigraphic modes with 8 colors in 64X32 and 64X48
 - 8 full graphic modes with 2 sets of 4 colors ranging from 64X64 to 128X192, and 2 sets of 1 color in 256X192
- ASSEMBLED & TESTED \$295.00

EXCELTRONIX ALSO CARRIES AN ABUNDANCE OF THE FOLLOWING COMPONENTS:

- 74LSXX
- 74XX
- CMOS
- LINEAR
- MEMORY
- Discrete Component
- Microprocessors and Peripheral Chips
- Connectors, Sockets, and a full line of electronic hardware

TO ORDER: EXCELTRONIX COMPONENTS & COMPUTING INC.,
319 College Street,
Toronto, Ontario,
Canada. M5T 1S2

Phone Order: 1-416-921-5295
VISA/MASTER CHARGE

Ontario orders add provincial sales tax.

Exceltronix
Components & Computing Inc.

BUY ONE of these great professional books when you join the

McGraw Hill



MINICOMPUTER SYSTEMS, Organization, Programming, and Applications. By Richard H. Eckhouse, Jr. and L. Robert Morris. 2nd Ed., 491 pp., illus. Updated, revised, and expanded, this is a book for every systems programmer, systems designer, computer scientist, and application specialist who wants to know more about microcomputer hardware, software, and design. 787/026 Pub Pr., \$21.95 Club Pr., \$17.75

MICROELECTRONICS: Digital and Analog Circuits and Systems. By Jacob Millman. 801 pp., 700 illus. Exciting news for the thousands of engineers who want a thorough refresher and updating on today's ICs. Will be welcomed by both digital and analog electronics engineers at every level of proficiency. 423/27X Pub Pr., \$24.50 Club Pr., \$19.50

AUTOMATIC DATA PROCESSING HANDBOOK. Edited by The Diebold Group. 976 pp., 269 illus. Written by a staff of internationally recognized authorities on ADP, this comprehensive handbook explains systems, programming and the languages, communications processes, and the design and installation of today's computers. 168/075 Pub Pr., \$38.95 Club Pr., \$25.75

THE Z-80 MICROCOMPUTER HANDBOOK. By William Barden, Jr. 304 pp., illus., paperbound. This book gives you the entire "state of the art" in microcomputer technology today. Arranged in three convenient and logically developed sections, the book discusses architecture and interface signals, then powerful interrupt sequences of Z-80 and interfacing examples of I/O memory devices. 784/914 Pub Pr., \$8.95 Club Pr., \$7.60

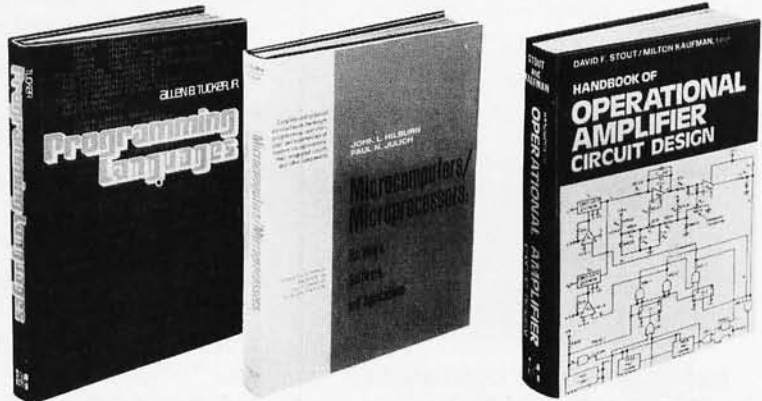

BE SURE TO CONSIDER THESE IMPORTANT TITLES AS WELL—

APPLYING MICROPROCESSORS, New Hardware, Software, and Applications. Edited by L. Altman & S. E. Scrupski. 191/603 Pub. Pr., \$19.50 Club Pr., \$15.50

57 PRACTICAL PROGRAMS & GAMES IN BASIC. By K. Tracton. 784/957 Pub. Pr., \$10.95 Club Pr., \$9.30

MICROPROCESSOR ARCHITECTURE AND PROGRAMMING. By W. F. Leahy. 784/612 Pub. Pr., \$19.95 Club Pr., \$14.95

MICROPROCESSOR AND MICROCOMPUTER SYSTEMS. By G. V. Rao. 783/659 Pub. Pr., \$24.50 Club Pr., \$19.50

THE BASIC COOKBOOK. By K. Tracton. 786/615 Pub. Pr., \$7.95 Club Pr., \$6.75

MICROPROCESSOR PROGRAMMING FOR COMPUTER HOBBYISTS. by N. Graham. 783/56X Pub. Pr., \$12.95 Club Pr., \$10.95

ILLUSTRATED DICTIONARY OF MICRO-COMPUTER TERMINOLOGY. By M. Hordeski. 786/631 Pub. Pr., \$12.95 Club Pr., \$10.95

HOME COMPUTER PROGRAMS. By J. W. Trudell, Jr. & M. Landberg. 787/042 Pub. Pr., \$8.95 Club Pr., \$7.60

FUNDAMENTALS OF COMPUTER ALGORITHMS. by E. Horowitz & S. Sahni. 786/380 Pub. Pr., \$19.95 Club Pr., \$15.95

ELECTRONICS DICTIONARY. By J. Markus. 404/313 Pub. Pr., \$24.50 Club Pr., \$19.50

HANDBOOK OF OPERATIONAL AMPLIFIER CIRCUIT DESIGN. By D. F. Stout; edited by M. Kaufman. 434 pp., 223 illus. Compact, concise, and highly concentrated, this unique "one-stop" designer's handbook contains an enormous amount of information. 617/97X Pub Pr., \$29.65 Club Pr., \$17.50

PRINTED CIRCUITS HANDBOOK. Edited by C. F. Coombs, Jr. 2nd Ed., 634 pp., 595 illus. Covering the subject of printed circuits from the design's idea to final acceptance, this enormously well-received work includes double-sided plated boards through printed boards and also the major variations such as multilayer and flexible circuits. 126/089 Pub Pr., \$32.50 Club Pr., \$24.50

PRINCIPLES OF INTERACTIVE COMPUTER GRAPHICS. By William M. Newman and Robert Sproull. 2nd Ed., 544 pp., illus. Now in a revised, updated Second Edition, this is a volume that has long been THE standard source of information for designers! 463/387 Pub. Pr., \$24.95 Club Pr., \$19.95

PROGRAMMABLE CALCULATORS. By Charles J. Sippl and Roger J. Sippl. 526 pp., illus, 6 1/2 x 10 format, paperbound. Profusely illustrated, this book analyzes pocket "programmable" calculators. The authors concentrate on the trade-up models that users will soon be purchasing. 784/493 Pub Pr., \$13.95 Club Pr., \$11.50

THE 8080A BUGBOOK: Microcomputer Interfacing and Programming. By Peter R. Rony, David G. Larsen, and Jonathan A. Titus. 416 pp., with figures, charts, and tables, paperbound. Gives you the basic concepts of microcomputer interfacing and the associated microcomputer I/O programming to develop your own interfaces. For the 8080 user, this book will be invaluable. 783/845 Pub Pr., \$9.95 Club Pr., \$8.45

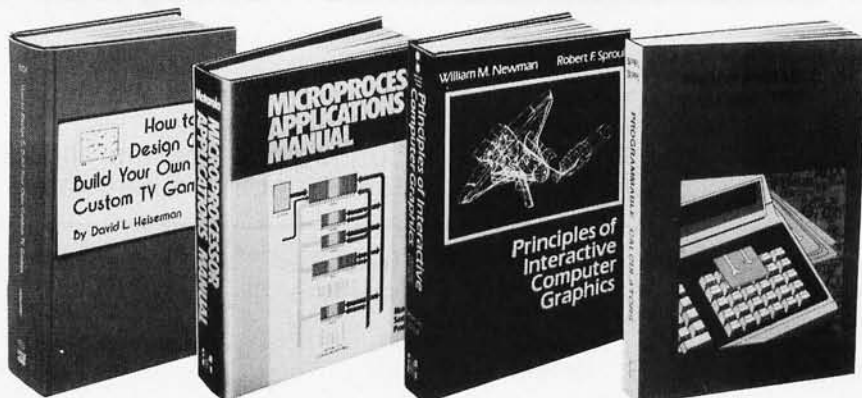

and GET ONE FREE (values up to \$60.00) COMPUTER PROFESSIONALS' BOOK CLUB.

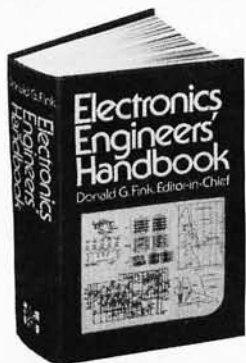

ELECTRONICS ENGINEERS' HANDBOOK. Editor in Chief, D. G. Fink. 2,104 pp., 2026 illus. Brings together in one instant-reference volume the essential principles, data, and design information known today on the components, circuits, equipment, and systems of all the various specialties that make up modern electronics.
209/804 Pub Pr., \$52.50 Club Pr., \$37.50

ELECTRONIC GAMES, Design, Programming and Troubleshooting. By W. H. Buchsbaum and R. Mauro. 335 pp., 338 illus. Information you need to design, program, and troubleshoot electronic games is right here in this widely popular hands-on guide.
087/210 Pub Pr., \$17.50 Club Pr., \$14.00

MEMORY DESIGN: Microcomputers to Mainframes Edited by LAURENCE ALTMAN. 192 pp., illus., 8 1/2 x 11 format Keep "up" with memory chips, through this collection of key articles from *Electronics* magazine. Data, diagrams, and discussions put all the technology to work for you in one authoritative book—a volume so up to date, it's a pleasure to use.
191/549 Pub. Pr., \$18.50 Club Pr., \$15.50

PROGRAMMING LANGUAGES. By Allen B. Tucker, Jr. 439 pp., illus. Gives you not only the principles of design but the applications of six major programming languages. Shows you their strengths and weaknesses in solving various representative "benchmark" problems.
654/158 Pub Pr., \$22.00 Club Pr., \$16.50

MICROCOMPUTERS/MICROPROCESSORS Hardware, Software, and Applications. By John L. Hilburn and Paul N. Julich. 372 pp., illus. Expressly created for people involved in the design, use, or maintenance of digital systems using microcomputers. The authors describe the theory and workings behind microprocessor architecture, read-only memory (ROM), random-access memory (RAM), and input/output interfacing methods.
771/449 Pub Pr., \$22.50 Club Pr., \$16.50

LOGIC DESIGNER'S MANUAL. By John D. Lenk. 504 pp., illus. Written for logic IC users rather than for designers of logic ICs, this book uses time-tested existing commercial logic ICs to solve all design and application problems.
784/671 Pub Pr., \$18.95 Club Pr., \$15.75

HOW TO DESIGN AND BUILD YOUR OWN CUSTOM TV GAMES. By David L. Heiserman. 544 pp., illus. Shows you how to create and build TV games from scratch and modify the ones you already have.
786/585 Pub Pr., \$14.95 Club Pr., \$11.95

MICROPROCESSOR APPLICATIONS MANUAL. By Motorola Semiconductor Products, Inc. 720 pp., illus., 8 1/2 x 11 format. With nuts-and-bolts practicality, this manual by the Motorola people (who should know) gives you detailed applications information on microprocessors and assumes no prior knowledge on your part about MPUs.
435/278 Pub Pr., \$38.00 Club Pr., \$26.50

PERSONAL COMPUTING: Hardware and Software Basics ELECTRONIC BOOK SERIES. 224 pp., 175 illus., outsized 8 1/2 x 11 format Gives you comprehensive guidance to the present state of the art in personal computers—an overall survey of the technology, and methods available to perform various tasks, facts about the work others are doing—and just how they are doing it.
191/514 Pub. Pr., \$14.95 Club Pr., \$11.95

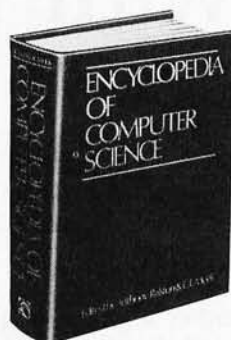

ENCYCLOPEDIA OF COMPUTER SCIENCE. Edited by Anthony Ralston and C. L. Meek. 1,500 pp., 60 illus., 100 charts, 7 x 10 format. This first and only in-depth coverage of the entire field of computer science in a single volume is comprehensive and completely up to date.
769/01X Pub Pr., \$60.00 Club Pr., \$39.95

ANALOG SYSTEMS FOR MICROPROCESSORS AND MINICOMPUTERS. By Patrick H. Garrett. 248 pp., illus. Explores all possibilities for analog systems in one applications oriented volume—with many specific examples.
786/496 Pub Pr., \$18.95 Club Pr., \$14.95

Choose any one of these books at the special club discount, and select any other as your gift Free of Charge when you enroll.

Why YOU should join now!

- **BEST BOOKS IN YOUR FIELD**—Books are selected from a wide range of publishers by expert editors and consultants to give you continuing access to the latest books in your field.
- **BIG SAVINGS**—Build your library and save money too! We guarantee savings of at least 15% off publishers' list prices on every book. Usually 20%, 25% or even higher!

• **BONUS BOOKS**—You will immediately begin to participate in our Bonus Book Plan that allows you savings between 70-80% off the publisher's price of many books.

- **CONVENIENCE**—14 times a year you receive the Club Bulletin FREE, fully describing the Main Selection and alternate selections, together with a dated reply card. If you want the Main Selection, you simply do nothing—it will be shipped automatically. If you want an alternate selection—or no book at all—you simply indicate it on the regular reply card and return it by the date specified. You will have at least 10 days to decide. If, because of late mail delivery of the Bulletin you should receive a book you do not want, just return it at the Club's expense.

As a Club member, you agree only to the purchase of four books (including your first selection) over a two-year period.

Computer Professionals' Book Club

P.O. Box 582, Hightstown, New Jersey 08520

Please enroll me as a member and send me the two books indicated, billing me for my first selection only at the discounted member's price, plus local tax, postage and handling. If not satisfied, I may return the books within 10 days and my membership will be canceled. I agree to purchase a minimum of 3 additional books during the next 2 years as outlined under the club plan described in this ad. Membership in the club is continuous but cancellable by me any time after the four book purchase requirement has been fulfilled.

Write Code # of
FREE selection here

Write Code # of
FIRST selection here

Orders from outside the U.S. must be prepaid with international money orders in U.S. dollars.

Charge my VISA MASTER CHARGE* Exp. Date _____

Credit Card # _____ *MC Bank # _____

Signature _____

Name _____

Address _____

City, State, Zip _____

Corporate Affiliation _____

This order subject to acceptance by McGraw-Hill. All prices subject to change without notice. Offer good only to new members. A postage and handling charge is added to all shipments.

P39456

Landing Module Simulation with Random Surface

S J Houng
E 36 Salmon St
Spokane WA 99218

This article describes a program that simulates the landing of a jet-propelled craft on a random surface. The surface is generated by a random-number generator. As seen in photo 1, the craft can be steered vertically or horizontally by the firing of the main jet, the side jets, or

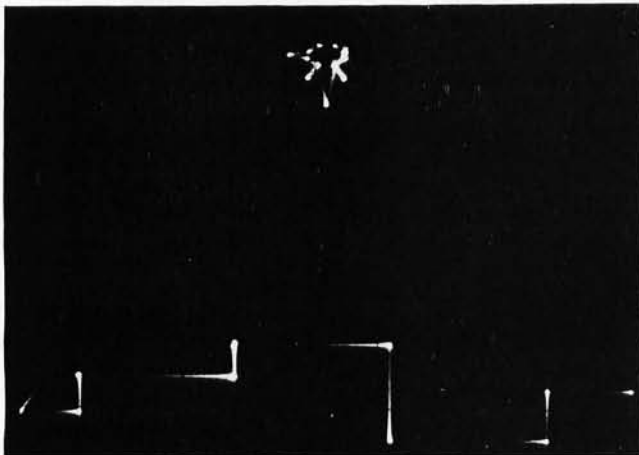

Photo 1: Landing module hovering over the five-segment random surface as it cautiously approaches its landing site.

both of them. During the dynamic simulation, the craft will move vertically along the central vertical line of the oscilloscope. The horizontal movement of the random surface causes the craft to appear to move in the opposite direction.

The sequence of the simulation is as follows:

- The dynamic equations of the craft are solved by Euler's method. The solutions are velocity and displacement.
- The craft is displayed according to the vertical

displacement, and the jets are made visible when they are fired.

- The random surface is displayed relative to the horizontal displacement of the craft. There are 256 segments of random surface which form a continuous terrain. Only five surface segments are shown on the oscilloscope at one time.
- When the craft has touched down on the surface, the vertical and horizontal velocity are compared with the crash velocity. If the craft exceeds the crash velocity, it will disappear from the screen. If it lands safely, it will remain on the surface waiting for lift-off.

The needed hardware is: a Motorola MEK6800 D2 Kit, two 8-bit digital-to-analog (D/A) converters, and an oscilloscope with DC inputs, as shown in figure 1. The capacitors at the output of the digital-to-analog converter are used to obtain a straight line display between two points. The keyboard will be used to enter the following commands:

- G — Go to start the simulation
- M — Main jet firing
- R — Right jet firing
- P — Left jet firing

After the program has been entered, the micro-processor will be directed to execute the program beginning at hexadecimal address 00F1 (listing 1). The oscilloscope will display a stationary craft and a random surface. Closure of the G key will start the dynamic simulation. Now you may control the firing of jet engines by pressing the M, R, or P keys. The objective of the control is to land safely. If the craft crashes, it will disappear from the screen. By pressing the G key, a new craft for you to command will appear on the screen. A star will be

At Last! Affordable WORD PROCESSING Made Possible by TRS-80™

NEW SCRIPSIT™
Word Processing
Software for 16K
Level II TRS-80s.
\$69⁹⁵ Cassette*
\$99⁹⁵ Disk*

**NEW UPPER
AND LOWER
CASE KIT.**
Available for
new or exist-
ing systems.
\$99 Installed*

EDIT, DELETE, MODIFY—
then print it error-free, 45
characters per second!

**NEW TRS-80 DAISY
WHEEL PRINTER.**
Clean and readable
printing, like the very
finest electric type-
writers.
\$2999*



RADIO SHACK BRINGS YOU A COMPLETE WORD PROCESSING SYSTEM FOR TRS-80 MODEL I COMPUTERS.

Radio Shack smashes another computer "cost barrier" with the new TRS-80 Word Processing System. The system includes our new SCRIPSIT software, Upper/Lower Case Kit and Daisy Wheel Printer. Add it to any 16K Level II TRS-80, or buy a complete system. Once you've tried it, you may never want to use a typewriter again!

The new SCRIPSIT software lets you compose letters and documents of all types on TRS-80's screen in upper case, or upper and lower case with the new Upper/Lower Case Kit. You can move words or entire paragraphs, insert, delete and edit to your heart's content! SCRIPSIT gives you automatic page numbers, page headings and footnotes and makes it easy to indent paragraphs, change line widths, and center your text horizontally or

vertically. Advanced features include justification, hyphenation, global search/replace, and variable screen width. On-going reports, form letters and text with print commands can be stored on TRS-80 cassettes or diskettes for use or revision at any time.



SCRIPSIT software includes an audio cassette course that makes anyone a proficient word processing operator.

PRINT ALL OF THE "ORIGINALS" YOU NEED, FAST AND ERROR-FREE!

Our new WP-50 Daisy Wheel Printer is fast and gives you the same quality of the finest electric typewriters — carbon film ribbon and all! Or, if your job doesn't require "letter" quality, a TRS-80

system with a dot matrix, u/lc printer costs even less.

A complete TRS-80 cassette system with Word Processing Software, Upper/Lower Case Kit and a dot matrix printer is yours for just \$2,046.95*. Or choose a really deluxe system with the WP-50 Printer and two floppy disks that store eight hours of 50 WPM typing for only \$5,492.95*.

Sound exciting? You bet it is! Visit your nearest Radio Shack outlet or write for details.

*Retail prices may vary at individual stores and dealers.

Mail to: Radio Shack, Dept. CMA-427
1300 One Tandy Center
Fort Worth, Texas 76102

I'd Like to Know More!

- Send details on TRS-80 Word Processing and the 24-page TRS-80 Catalog #RSC-3.
 Have a representative contact me.

NAME _____

ADDRESS _____

CITY _____

STATE _____ ZIP _____

I Own/Use a TRS-80 Yes No

Model _____

Radio Shack®
The biggest name in little computers™

A DIVISION OF TANDY CORPORATION • FORT WORTH, TEXAS 76102

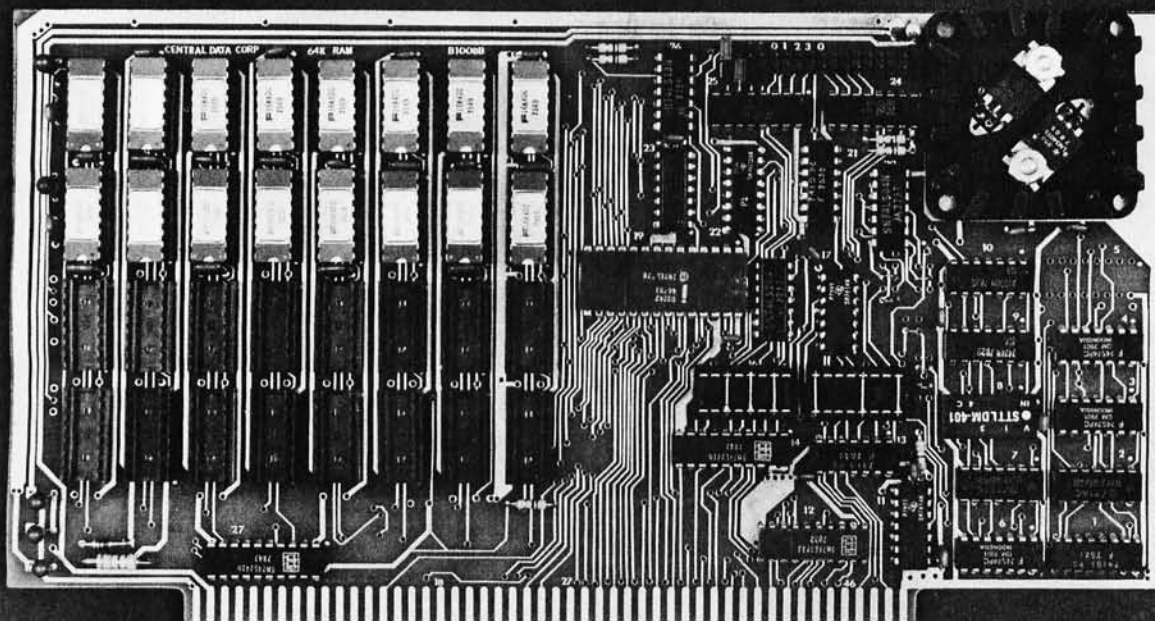

32K Board Pictured Above

Why Not the Best?

From The Dynamic RAM Company.

2MHz	4MHz
16K—\$249	\$259
32K—\$375	\$395
48K—\$500	\$530
64K—\$625	\$665

We have now been shipping our 2MHz dynamic RAM boards for over two years. Hundreds of 4MHz boards have been going out every month since early 1979. Our reliability is proven in the thousands of systems which contain our board. Many quality-minded systems houses across the country and overseas are using our boards for their equipment.

Our prices still beat all. Despite rising 16K memory chip prices (at least from reputable suppliers), Central Data continues to give you the best buy in memory today. Nobody offers a board with a capacity of 64K, assembled, tested, and guaranteed for a full year at the price we do.

Deselect around PROMs. Our boards have the important deselect feature which lets you overlap any fixed memory in your system with no interference.

Our features make the board easily used and expanded. You address our boards on 16K boundaries with mini-jumps (small shorting plugs that slide over wire-wrap pins) near the top of the board for easy access. If you want to expand your board after you have purchased it, all that you need to do is add memory. We can supply you with expansion packages (\$150-2MHz, \$160-4MHz) which include eight RAMs that you can depend on as well as two mini-jumps for addressing. And of course, our board **never** generates wait states.

Low power consumption keeps your computer running cool and reliable. The total power consumption of our 16K board is typically less than 4 watts (+8V @ 300ma, +16V @ 150ma and

–16V @ 20ma). Boards with additional memory typically increase power consumption only 1 watt per 16K!

Standard S-100 Interface. Our board is designed to interface with any standard S-100 CPU. All of the timing of the board is independent of the processor chip, and the board is set up for different processors by changing two plugs on the board.

Call or write us today. That will guarantee a fast response with more information on the board. Or make an order — you'll probably have the board in two weeks! **If you're interested, also ask for a catalog on our Z8000 16-bit processor board designed for the MULTIBUS.** All of these products are available to your local dealer, also.

Central Data Corporation, 713 Edgebrook Drive, PO Box 2530, Station A, Champaign, IL 61820. (217) 359-8010

Central Data

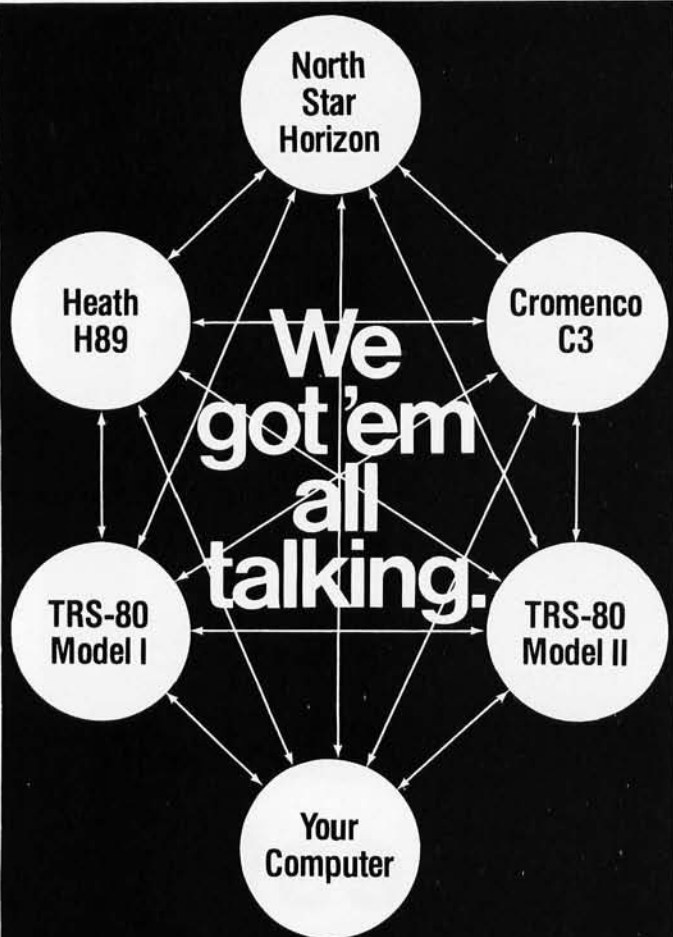

BSTAM

Byrom Software Telecommunications Access Method

The missing link between any CP/M or TRSDOS computers!

A commercially oriented telecommunications facility for transmitting and receiving CP/M* and TRSDOS** files, BSTAM has BIG computer features for your micro:

- links computers directly at 9600 baud with UARTS, or via phone lines using modems
- full speed data transfer without hex conversion overhead
- full wildcard expansions to send * .COM, etc.
- reliable error detection and automatic retry with console messages for status and errors

It's Terrific!
 We use it ourselves!
\$150 PER COMPUTER **\$5** MANUAL ALONE

Prices reflect distribution on 8" single density diskettes. If a format is requested which requires additional diskettes, a surcharge of \$5. per additional diskette will be added.
 *CP/M is a trademark of Digital Research
 **TRSDOS is a trademark of Tandy Corporation

Lifeboat Associates
 2248 Broadway New York, N.Y. 10024 (212) 580-0082 Telex: 220501



Listing 1 continued:

00052	0044	2E	02		BGT	LFIRE	52.
00053	0046	D6	09		LDA B	JR	53.
00054	0048	8D	03	LFIRE	BSR	EULER	54.
00055	004A	97	01		STA A	X2	55.
00056	004C	39			RTS		56.
00057	004D	CE	0002	EULER	LIX	##2	57.
00058	0050	57		EO	ASR B		58.
00059	0051	09			DEX		59.
00060	0052	26	FC		BNE	EO	60.
00061	0054	1B			ABA		61.
00062	0055	39			RTS		62.
00063	0056	D6	04	RAND	LDA B	RND	63.
00064	0058	17			TBA		64.
00065	0059	58			ASL B		65.
00066	005A	58			ASL B		66.
00067	005B	1B			ABA		67.
00068	005C	58			ASL B		68.
00069	005D	1B			ABA		69.
00070	005E	4C			INC A		70.
00071	005F	97	04		STA A	RND	71.
00072	0061	39			RTS		72.
00073	0062	D6	0E	SRFGEN	LDA B	ODOM	73.
00074	0064	D7	0D		STA B	TEMP	74.
00075	0066	D6	05		LDA B	RND0	75.
00076	0068	D7	04		STA B	RND	76.
00077	006A	8D	EA	NXT	BSR	RAND	77.
00078	006C	7A	000D		DEC	TEMP	78.
00079	006F	26	F9		BNE	NXT	79.
00080	0071	CE	0010		LIX	##GETSRF	80.
00081	0074	C6	05		LDA B	##5	81.
00082	0076	D7	0D		STA B	TEMP	82.
00083	0078	8D	DC	NXTS	BSR	RAND	83.
00084	007A	44			LSR A		84.
00085	007B	44			LSR A		85.
00086	007C	A7	00		STA A	O,X	86.
00087	007E	08			INX		87.
00088	007F	7A	000D		DEC	TEMP	88.
00089	0082	26	F4		BNE	NXTS	89.
00090	0084	39			RTS		90.
00091	0085	7F	000F	BXING	CLR	FLAG4	91.
00092	0088	96	00		LDA A	X1	92.
00093	008A	84	3F		AND A	##3F	93.
00094	008C	81	30		CMF A	##30	94.
00095	008E	2A	09		BPL	XING	95.
00096	0090	81	10		CMF A	##10	96.
00097	0092	2B	05		BMI	XING	97.
00098	0094	84	20		AND A	##20	98.
00099	0096	97	15		STA A	B5	99.
00100	0098	39			RTS		100.
00101	0099	84	20	XING	AND A	##20	101.
00102	009B	16			TAB		102.
00103	009C	90	15		SUB A	B5	103.
00104	009E	27	0F		REQ	OUT	104.
00105	00A0	2B	05		BMI	PLUS	105.
00106	00A2	7A	000E		DEC	ODOM	106.
00107	00A5	20	03		BRA	SAVE	107.
00108	00A7	7C	000E	PLUS	INC	ODOM	108.
00109	00AA	7C	000F	SAVE	INC	FLAG4	109.
00110	00AD	D7	15		STA B	B5	110.
00111	00AF	39		OUT	RTS		111.
00112	00B0	8D	D3	TERR	BSR	BXING	112.
00113	00B2	D6	0F		LDA B	FLAG4	113.
00114	00B4	27	02		REQ	SDSFLY	114.
00115	00B6	8D	AA		BSR	SRFGEN	115.
00116	00B8	8D	01C0	SDSFLY	JSR	SURF	116.
00117	00BB	39			RTS		117.
00118	00BC	4F		KEY	CLR A		118.
00119	00BD	97	0A		STA A	FLAG1	119.
00120	00BF	97	0B		STA A	FLAG2	120.
00121	00C1	86	20		LDA A	##20	121.
00122	00C3	8D	25		BSR	TKEY	122.
00123	00C5	2B	03		BMI	L	123.
00124	00C7	7C	000A		INC	FLAG1	124.
00125	00CA	86	10	L	LDA A	##10	125.
00126	00CC	8D	1C		BSR	TKEY	126.
00127	00CE	2B	03		BMI	R	127.
00128	00D0	7C	000B		INC	FLAG2	128.
00129	00D3	86	A0	R	LDA A	##A0	129.
00130	00D5	8D	13		BSR	TKEY	130.
00131	00D7	2B	03		BMI	EXT	131.
00132	00D9	7A	000B		DEC	FLAG2	132.

Listing 1 continued on page 136

IDS Announces S-100 Energy Management Module

The 100-EMM Energy Management Module provides temperature measurement at four separate locations indoors or out; monitors eight (8) doors, windows, or fire sensors; controls six external devices via relay or optoisolator; and provides an intrusion alarm with battery backup (alarm operates even during primary power outages). Put the 100-EMM to use in your home or business and claim a 30% tax credit for the cost of your S-100 computer system including the 100-EMM. (Purchasing the 100-EMM can actually save you several times its cost in tax credits. Full instructions for filing are included in the 100-EMM manual.)

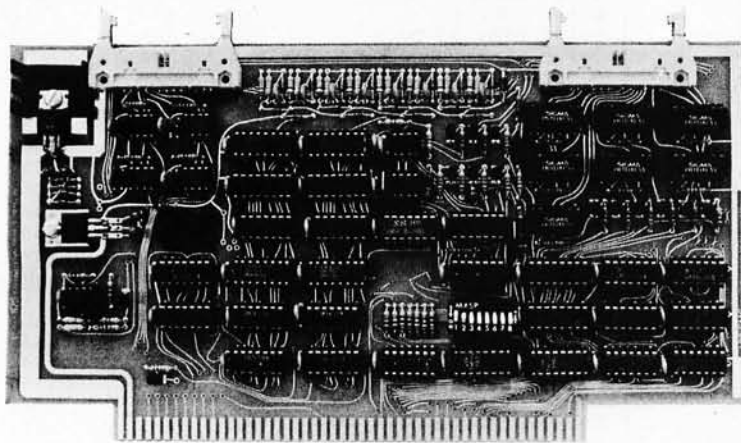

**BUY THIS S-100 BOARD
AND GET UP TO A 30%
TAX CREDIT BASED ON
THE COST OF YOUR
COMPUTER SYSTEM!**

**100-EMM Energy Management Module
Assembled and Tested \$395.00
Kit \$345.00**

Options for 100-EMM:

CP-52 Cable Panel - Terminates two 26-conductor flat cables in 26 screwlugs. Use it for convenient interconnection of the 100-EMM to the "outside world". **\$45.00**

CABL-26-STD 26-Conductor Flat Ribbon Cable - Four feet in length with connectors for 100-EMM and CP-52 above. **\$35.00** Other lengths available on special order. Add **\$1.00** per foot.

OTHER PRODUCTS FROM IDS. The most complete source of S-100 compatible modules for process control, data acquisition, energy management, and data communications.

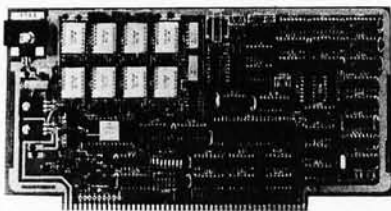

88-MODEM S-100 ORIGINATE/ANSWER MODEM WITH AUTO-DIALER. Software selectable baudrate provides any baudrate from 66-600 baud. Provides 1.5 stop bits when operated in 5-bit code mode. Auto-answer programs available for CROMEMCO CDOS, CP/M, North Star Horizon and MDS, and Alpha Micro.

Assembled and Tested \$395.00 Kit \$245.00

88-UFC UNIVERSAL FREQUENCY COUNTER

Four software selected inputs. Measure frequency from 0-650 MHz and period from .1µs to 1 Second. Extensive software included.

Assembled and Tested \$299.00 Kit \$199.00 Temperature-Compensated Crystal Oscillator option **\$145.00**

88-SAI SYNCHRONOUS/ASYNCHRONOUS INTERFACE

The most versatile serial interface on the market. Computer access/control of all data and handshake lines and provision for masked interrupts, inversion of any input or output signal, and onboard baudrate generation for 110, 134.5, 150, 300, 600, 1200, 2400, 4800, 9600, and many other baud rates. Many more features.

Assembled and Tested \$299.00 Kit \$199.00

88-SPM TIME OF DAY CLOCK with battery backup. Set the clock with three out instructions: no delays! Programs included in North Star BASIC, CBASIC, and 8080 assembly language.

Assembled and Tested with crystal option \$199.00 Kit less crystal option \$99.00 Crystal Option Kit \$25.00

88-RCB RELAY CONTROL BOARD

16 Relays on one board. Control appliances, production equipment, or even musical instruments (See BYTE Magazine Sept 1977 page 12)

Assembled and Tested \$299.00 Kit \$199.00

**INTERNATIONAL
DATA SYSTEMS, INC.**

Mailing Address:

Post Office Box 17269
Dulles International Airport
Washington, DC 20041

Telephone (703)661-8442

Shipping Address:

400 West Service Road, Suite 130
Dulles International Airport
Washington, DC 20041 USA

TELEX 901112 IDS CTLY

CP/M[®]2

NOW BETTER THAN EVER

- Control Program for Microcomputers.
- Includes Editor, Assembler, Debugger, Utilities.
- Supports Floppy Disks and Hard Disks.
For 8080, 8085, Z-80, MDS.
- \$150-Diskette and Documentation
- \$25-Documentation only

MP/M[™]

NEW INDUSTRY STANDARD

- Multi-terminal access.
- Multi-programming.
- CP/M-compatible.
- Real-time features.
- \$300-Diskette and Manual
- \$25-Manual only

DIGITAL RESEARCH

OPTIONAL SOFTWARE PACKAGES

MAC[™] MACRO ASSEMBLER:

- Compatible with new Intel macro standard.
- Complete guide to macro applications.
- \$90-Diskette and Manual.

SID[™] SYMBOLIC DEBUGGER:

- Symbolic memory reference.
- Built-in assembler/disassembler.
- \$75-Diskette and Manual.

TEX[™] TEXT FORMATTER:

- Powerful text formatting capabilities
- Text prepared using CP/M Editor.
- \$75-Diskette and Manual.

DESPOOL[™]

- Background print utility.
- Use with CP/M
- \$50-Diskette and Manual.

DIGITAL RESEARCH[®]
P.O. Box 579 • Pacific Grove, California 93950
(408) 649-3896

Listing 1 continued:

```
00133 00DC 39      EXT   RTS      133.
00134 00DD 7F 000C GO   CLR     FLAG3 134.
00135 00E0 86 E0     LDA A  #E0    135.
00136 00E2 8D 06     BSR     TKEY  136.
00137 00E4 2B 03     BMI     0     137.
00138 00E6 7C 000C   INC     FLAG3 138.
00139 00E9 39        D     RTS      139.
00140 00EA B7 8022 TKEY STA A  SCNREG 140.
00141 00ED 7D 8020   TST     DISREG 141.
00142 00F0 39        RTS      142.
00143 00F1 7F 8005 BEGIN CLR     CRA   143.
00144 00F4 7F 8007   CLR     CRB   144.
00145 00F7 86 FF     LDA A  #FFF   145.
00146 00F9 B7 8004   STA A  FIA   146.
00147 00FC B7 8006   STA A  FIB   147.
00148 00FF 86 25     LDA A  #25   148.
00149 0101 B7 8005   STA A  CRA   149.
00150 0104 B7 8007   STA A  CRB   150.
00151 0107 4F        INIT  CLR A     151.
00152 0108 97 03     STA A  Y2    152.
00153 010A 86 0A     LDA A  #A    153.
00154 010C 97 01     STA A  X2    154.
00155 010E 86 60     LDA A  #60   155.
00156 0110 97 02     STA A  Y1    156.
00157 0112 86 20     LDA A  #20   157.
00158 0114 97 0E     STA A  OD0M  158.
00159 0116 96 04     LDA A  RND   159.
00160 0118 97 05     STA A  RND0  160.
00161 011A 8D 5C     START BSR     LANDER 161.
00162 011C 8D 00B0   JSR     TERR  162.
00163 011F 8D 8C     BSR     GO    163.
00164 0121 D6 0C     LDA B  FLAG3 164.
00165 0123 27 F5     REQ     START 165.
00166 0125 8D 95     MOTION BSR     KEY  166.
00167 0127 8D 0016   JSR     SYS   167.
00168 012A 8D 4C     BSR     LANDER 168.
00169 012C 8D 4A     BSR     LANDER 169.
00170 012E 8D 48     BSR     LANDER 170.
00171 0130 8D 00B0   JSR     TERR  171.
00172 0133 96 02     LDA A  Y1    172.
00173 0135 8B 80     ADD A  #80   173.
00174 0137 90 12     SUB A  SUR   174.
00175 0139 22 EA     BHI     MOTION 175.
00176 013B 81 FB     CMP A  #FB   176.
00177 013D 2B 10     BMI     CRASH 177.
00178 013F 96 01     LAND  LDA A  X2  178.
00179 0141 81 08     CMP A  #8    179.
00180 0143 2A 0A     BPL     CRASH 180.
00181 0145 81 FB     CMP A  #FB   181.
00182 0147 2B 06     BMI     CRASH 182.
00183 0149 96 03     LDA A  Y2    183.
00184 014B 81 F0     CMP A  #F0   184.
00185 014D 2A 0B     BPL     SAFE  185.
00186 014F 8D 00B0   CRASH JSR     TERR  186.
00187 0152 8D 89     BSR     GO    187.
00188 0154 D6 0C     LDA B  FLAG3 188.
00189 0156 2E AF     BGT     INIT  189.
00190 0158 20 F5     BRA     CRASH 190.
00191 015A C6 04     SAFE  LDA B  #4   191.
00192 015C D7 03     STA B  Y2    192.
00193 015E 5F        CLR B     193.
00194 015F D7 01     STA B  X2    194.
00195 0161 D7 0A     STA B  FLAG1 195.
00196 0163 D7 0B     STA B  FLAG2 196.
00197 0165 CE A04D SF   LDX     #S    197.
00198 0168 8D 39     BSR     DSPLY 198.
00199 016A 8D 0C     BSR     LANDER 199.
00200 016C 8D 00B0   JSR     TERR  200.
00201 016F 8D 00DD   JSR     GO    201.
00202 0172 D6 0C     LDA B  FLAG3 202.
00203 0174 2E AF     BGT     MOTION 203.
00204 0176 20 ED     BRA     SF    204.
00205 0178 CE 01F1 LANDER LDX     #TOP  205.
00206 017B 8D 26     BSR     DSPLY 206.
00207 017D D6 0B     LDA B  FLAG2 207.
00208 017F 2F 05     BLE     RJET  208.
00209 0181 CE 01FA   LDX     #LJ   209.
00210 0184 8D 1D     BSR     DSPLY 210.
00211 0186 CE A031 RJET  LDX     #LS   211.
00212 0189 8D 18     BSR     DSPLY 212.
00213 018B D6 0A     LDA B  FLAG1 213.
```

Listing 1 continued on page 138

TIME after TIME



BATTERY SUPPORTED CALENDAR CLOCKS

PDP-11*

TCU-100 • \$495

- Provides month, day, hour, minute and second.
- Can interrupt on date/time, or periodic intervals.

TCU-150 • \$460

- Provides year, month, day, hour, minute and second.
- Automatic leap year.
- Patches for RSX-11M, RT-11 FB/SJ VO2, VO3 and UNIX.

LSI-11/2*

TCU-50D • \$325

- Provides month, day, hour, minute and second.
- Dual size board.
- Patches for RT-11 SJ/FB VO2, VO3B.

Lockheed SUE

TCU-200 • \$550

- Provides year, month, day, hour, minute, second and milli-second.
- Interval interrupts between 1/1024 seconds and 64 seconds.

Computer Automation (Naked Mini)

TCU-310 • \$385

- Provides year, month, day, hour, minute and second.

*Trademark of Digital Equipment Corporation

Multi-Bus**

TCU-410 • \$325

- Provides year, month, day, hour, minute and second.
- SBC/BLC compatible.

HP 2100

TCU-2100 • \$395

- Correct time restored after power failure.
- Compatible with the HP TBG card.

Serial Clock (RS 232 or 20 mA)

SLC-1 • \$640

- Connects between any terminal and host computer.
- Provides date, time and more!

All Digital Pathways TCUs have on board NICAD batteries to maintain time and date during power down. Timing is provided by a crystal controlled oscillator. Prices are U.S. domestic single piece. Quantity discounts available.

For more information on these products, contact:
Digital Pathways Inc.
4151 Middlefield Road
Palo Alto, CA 94306
Phone: (415) 493-5544

**Trademark of Intel Corporation

***Trademark of Computer Automation Incorporated



DIGITAL PATHWAYS

The days of complicated, unreliable, dynamic RAM are gone:

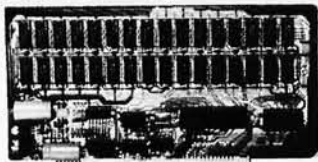

INTRODUCING JAWS

the ultrabyte memory board

\$199.95 (complete kit with 16K memory)

Netronics consistently offers innovative products at unbeatable prices. And here we go again—with JAWS, the ultrabyte 64K S100 memory board.

ONE CHIP DOES IT ALL

JAWS solves the problems of dynamic RAM with a state-of-the-art chip from Intel that does it all. Intel's single chip 64K dynamic RAM controller eliminates high-current logic parts... delay lines... massive heat sinks... unreliable trick circuits.

REMARKABLE FEATURES OF JAWS

Look what JAWS offers you: Hidden refresh... fast performance... low power consumption... latched data outputs... 200 NS 4116 RAMs... on-board crystal... 8K bank selectable... fully socketed... solder mask on both sides of board... designed for 8080, 8085, and Z80 bus signals... works in Explorer, Sol, Horizon, as well as all other well-designed S100 computers.

GIVE YOUR COMPUTER A BIG BYTE OF MEMORY POWER WITH JAWS—SAVE UP TO \$90 ON INTRODUCTORY LIMITED-OFFER SPECIAL PRICES!

UNDECIDED? TRY A WIRE 16K JAWS IN YOUR COMPUTER ON OUR 10-DAY MONEY-BACK OFFER (SPECIFY YOUR COMPUTER).

CONTINENTAL U.S.A. CREDIT CARD BUYERS: OUTSIDE CONNECTICUT CALL

CALL TOLL FREE 800-243-7428

From Connecticut Or For Assistance, (203) 354-9375 Dept. 1

NETRONICS RESEARCH & DEVELOPMENT LTD.
333 Litchfield Road, New Milford, CT 06776

Please send the items checked below:

- JAWS 16K RAM kit, No. 6416, \$199.95.*
- JAWS 16K RAM fully assembled, tested, burned in, No. 6416W, \$229.95.*
- JAWS 32K RAM kit, No. 6432, (reg. price \$329.95), SPECIAL PRICE \$299.95.*
- JAWS 32K RAM fully assembled, tested, burned in, No. 6432W, (reg. price \$369.95), SPECIAL PRICE \$339.95.*
- JAWS 48K RAM kit, No. 6448, (reg. price \$459.95), SPECIAL PRICE \$399.95.*
- JAWS 48K fully assembled, tested, burned in, No. 6448W, (reg. price \$509.95), SPECIAL PRICE \$449.95.*
- JAWS 64K RAM kit, No. 6464, (reg. price \$589.95), SPECIAL PRICE \$499.95.*
- JAWS 64K RAM fully assembled, tested, burned in, No. 6464W, (reg. price \$649.95), SPECIAL PRICE \$559.95.*
- Expansion kit, JAWS 16K RAM module, to expand any of the above in 16K blocks up to 64K, No. 16EXP, \$129.95.*

*All prices plus \$2 postage and handling. Connecticut residents add sales tax.

Total enclosed: \$

- Personal Check Money order or Cashiers Check
- VISA MASTER CHARGE (Bank No.)

Acct. No. _____ Exp. Date _____
Signature _____
Print Name _____
Address _____
City _____
State _____ Zip _____

Send me more information

Listing 1 continued:

00214	018D	27	05		REQ	NOJET	214.
00215	018F	CE	A03A		LIX	#MJ	215.
00216	0192	8D	0F		BSR	DSPLY	216.
00217	0194	CE	A03D	NOJET	LIX	#RS	217.
00218	0197	8D	0A		BSR	DSPLY	218.
00219	0199	D6	0B		LDA B	FLAG2	219.
00220	019B	2C	05		BGE	NORJ	220.
00221	019D	CE	A048		LIX	#RJ	221.
00222	01A0	8D	01		BSR	DSPLY	222.
00223	01A2	39		NORJ	RTS		223.
00224	01A3	A6	00	ISFLY	LDA A	0,X	224.
00225	01A5	27	12		REQ	END	225.
00226	01A7	B7	8004		STA A	PIA	226.
00227	01AA	A6	01		LDA A	1,X	227.
00228	01AC	9B	02		ADD A	Y1	228.
00229	01AE	8B	70		ADD A	#70	229.
00230	01B0	B7	8006		STA A	FIB	230.
00231	01B3	0B			INX		231.
00232	01B4	0B			INX		232.
00233	01B5	8D	03		BSR	TDELAY	233.
00234	01B7	20	EA		BRA	DSPLY	234.
00235	01B9	39		END	RTS		235.
00236	01BA	C6	80	TDELAY	LDA B	#80	236.
00237	01BC	5A		DELAY	DEC B		237.
00238	01BD	26	FD		BNE	DELAY	238.
00239	01BF	39			RTS		239.
00240	01C0	CE	0010	SURF	LIX	#GETSRF	240.
00241	01C3	4F			CLR A		241.
00242	01C4	E6	00		LDA B	0,X	242.
00243	01C6	B7	8004		STA A	PIA	243.
00244	01C9	F7	8006		STA B	FIB	244.
00245	01CC	8D	EC		BSR	TDELAY	245.
00246	01CE	96	00		LDA A	X1	246.
00247	01D0	43			COM A		247.
00248	01D1	84	3F		AND A	#3F	248.
00249	01D3	B7	8004	NEXTS	STA A	PIA	249.
00250	01D6	8D	E2		BSR	TDELAY	250.
00251	01D8	0B			INX		251.
00252	01D9	E6	00		LDA B	0,X	252.
00253	01DB	F7	8006		STA B	FIB	253.
00254	01DE	8D	DA		BSR	TDELAY	254.
00255	01E0	8C	0014		CFX	#GETSRF+4	255.
00256	01E3	27	04		REQ	LAST	256.
00257	01E5	8B	40		ADD A	#40	257.
00258	01E7	20	EA		BRA	NEXTS	258.
00259	01E9	86	FF	LAST	LDA A	#FF	259.
00260	01EB	B7	8004		STA A	PIA	260.
00261	01EE	8D	CA		BSR	TDELAY	261.
00262	01F0	39			RTS		262.
00263	01F1	8820		TOP	FDB	#8820,#8424,#7C24,#7820	263.
		01F3	8424				
		01F5	7C24				
		01F7	7820				
00264	01F9	00			FCB	\$00	264.
00265	01FA	701E		LJ	FDB	\$701E	265.
00266	01FC	00			FCB	\$00	266.
00267	A031				ORG	\$A031	267.
00268	A031	781C		LS	FDB	\$781C,\$7C18,\$7810,\$7C18	268.
		A033	7C18				
		A035	7810				
		A037	7C18				
00269	A039	00			FCB	\$00	269.
00270	A03A	8000		MJ	FDB	\$8000	270.
00271	A03C	00			FCB	\$00	271.
00272	A03D	8418		RS	FDB	\$8418,\$8810,\$8418,\$881C,\$8820	272.
		A03F	8810				
		A041	8418				
		A043	881C				
		A045	8820				
00273	A047	00			FCB	\$00	273.
00274	A048	901E		RJ	FDB	\$901E,\$881C	274.
		A04A	881C				
00275	A04C	00			FCB	\$00	275.
00276	A04D	8540		S	FDB	\$8540,\$8050,\$7B40,\$884A	276.
		A04F	8050				
		A051	7B40				
		A053	884A				
00277	A055	784A			FDB	\$784A,\$8540	277.
		A057	8540				
00278	A059	00			FCB	0	278.
00279					END		279.

Text continued from page 132:

we do not have much room to move around, but the landing simulation is very realistic. In numerical calculation the 2's complement arithmetic is used. The 2's complement number has a range of decimal -128 to +127, or hexadecimal 80 to 7F. Since the number can be positive or negative, the summation will only be sufficient to perform addition and subtraction. The shift instructions ASL and ASR can be used to perform multiplication or division by 2 respectively. By repeating the use of shift operation, it is possible to multiply or divide a number by 2, 4, 8, and so on.

The dynamic equations for the landing craft are given by the following four first-order ordinary differential equations:

$$\frac{dX_1}{dt} = X_2$$

$$\frac{dX_2}{dt} = \pm SJET$$

$$\frac{dY_1}{dt} = Y_2$$

$$\frac{dY_2}{dt} = -g + JET$$

where:

- X_1 = horizontal displacement
- X_2 = horizontal velocity
- $SJET$ = side jet thrust; negative for the right-hand side jet, positive for the left-hand side jet, and 0 when neither are firing
- Y_1 = vertical displacement
- Y_2 = vertical velocity
- g = gravity
- JET = main jet thrust; 0 when it is not firing
- t = time

According to the Euler's method (see reference on "Applied Numerical Methods"), an equation of the form:

$$\frac{dZ}{dt} = f(t, Z)$$

can be replaced by the following equivalent numerical routine:

$$\begin{aligned} Z_{n+1} &= Z_n + hf(t_n, Z_n) \\ t_{n+1} &= t_n + h \\ n &= 0, 1, 2, \dots \end{aligned}$$

where the quantity Z_{n+1} , at the time t_{n+1} , can be calculated by adding the previously calculated value Z_n , and the product of the time increment h and the function $f(t_n, Z_n)$. Starting from the given initial value Z_0 at t_0 , the solution for Z_n at t_n can be obtained by repeating the calculation from the Euler's routine. This concept has been carried

out in the program SYS (address 0016). An assumption is made that the time increment h is equal to $\frac{1}{4}$ second.

A total of 553 bytes of memory is needed for the program. If you have more memory space available, you may want to add more constraints to your simulation. The limited fuel capacity can be added to the program. The fuel gauge, velocity, altitude, displacement, and elapsed time can also be displayed on the screen. The trace between craft and surface can be blanked by the beam-intensity modulation. The control line on the peripheral interface adapter (PIA), such as CA2 or CB2, can be used for the blanking control.

The microprocessor can be a useful tool in the classroom for the dynamic simulation. An automobile traveling on a random surface can be an interesting subject for studying the suspension system. Even a simple mass, spring, and dashpot system would prove to be an interesting simulation to observe on the oscilloscope. ■

BIBLIOGRAPHY

1. Carnahan, B, H A Luther, and J O Wilkes, *Applied Numerical Methods*, John Wiley and Sons Inc, New York, 1969, chapter 6.
2. Grieser, D, "Pseudorandom Number Generator," *BYTE*, November 1977, page 218.
3. *M6800 Microprocessor Programming Manual*, Motorola Inc, chapter 4.

FOR YOU YOUR WIFE YOUR CHILD YOUR HOME YOUR SCHOOL YOUR BUSINESS



A Computer System Both Practical and Affordable!

- Many uses for your computer, ■ Word Processing ■ Accounting ■ Bookkeeping
- Games ■ Personal Records ■ Menu Planning ■ Educational Development
- Tax Preparation ■ Homework, etc.

BYTE SHOP EAST offers a wide selection of hardware to meet your specific needs; SORCERER, PET, APPLE, NORTH STAR, IMSAI, DIGITAL, and many, many others. BYTE SHOP EAST has a complete library of books and magazines to meet your needs.

Come in to our computer stores for a FREE demonstration!

BYTE SHOP EAST, INC.

130 East 40th St.
(Corner of Lexington Ave.)
New York 10016
Tues.-Fri. 10 - 6 Sat. 10 - 5
(212) 889-4204

2721 Hempstead Turnpike
(Just East of Wantagh Pkwy)
Levittown, N.Y. 11756
Tues.-Fri. 12 - 8 Sat. 10 - 5
(516) 731-8116

HARDSIDE™

6 South Street • Milford, New Hampshire 03055 • (603) 673-5144



PRINTERS

CENTRONICS 753-2...

This high speed, high density, dot matrix printer (180 CPS) features an 18 x 9 dot matrix and proportional spacing. 132 characters per line. Ideal for word processing and all business uses. Includes connecting cable.

List Price \$3295.00 **HardSide Price \$2795.00**



CENTRONICS 730...

This is the same printer as the new Radio Shack "Line Printer II". Prints at 100 characters per second, 8 inch lines of 80 characters each. Features upper and lower case letters, with wide letters under software control. Operates as both a friction feed and a pin feed printer. Uses paper up to 9½ inches wide. Can also handle a single sheet of paper. Includes connection cable.

List Price \$999.00 **HardSide Price \$899.00**

QUICK PRINTER II...



A "mini" line printer priced to fit everyone's budget. Connects directly to the keyboard without an expansion interface. Software selectable for 16 or 32 character lines of both upper and lower case letters. Automatic "wrap-around" so no data is lost.

List Price \$219.00 **HardSide Price \$197.00**

CALL TOLL FREE 1-800-258-1790



	LIST PRICE	OUR PRICE
EXPANSION INTERFACE:		
.... OK	\$299	\$269
.... 16K	\$448	379/403
.... 32K	\$597	479/537

DISK DRIVES:

Percom, TFD-100, 40-track		\$399
Percom, dual TFD-100		\$795
Percom, TFD-200, 77-track		\$675
2-drive cable		\$29
4-drive cable		\$39
Radio Shack, -0	\$499	\$469
Radio Shack, -1, 2, 3	\$399	\$459

ACCESSORIES:

Telephone Interface	\$199	\$179
16K Memory Kit		\$99
16K Memory Kit for E.I.		\$95
RS232-C Interface	\$99	\$89
TRS-232 Interface		\$49
Data Dubber		\$49



	LIST PRICE	OUR PRICE
TRS-80 COMPUTERS:		
Level-I 4K	\$499	\$449
Level-I 16K, w/keypad	\$729	\$659
Level-II 4K	\$619	\$559
Level-II 16K		\$669
Level-II 16K, w/keypad	\$849	\$769

PRINTERS:

Line Printer III	\$1999	\$1849
Centronics 779-2	\$1598	\$1095
Line Printer II	\$999	
Centronics 730	\$999	\$899
Centronics P1 *	\$499	\$419
Quick Printer II	\$219	\$197
QP-II Exp. Int. Cable	\$20	\$18
* Cable required	\$39	\$35

*Prices do not include shipping

* COD orders require 25% cash deposit

* Prices subject to change

*TRS-80 is a trademark of Radio Shack and Tandy Corp.

FREE

1 year subscription to The Eighty, monthly magazine for TRS-80* owners, with any order!

1-800-258-1790
TOLL FREE



The Software Exchange

6 South Street, Box 68, Milford, NH 03055

FREE CATALOGS

HardSide Hardware (24 pgs.)
TSE Software (64 pgs.)

2 DATA BASE MANAGERS!

Dynamic Data Base by Ken Knecht

Easy to use, flexible data base system on diskette. **\$39.95.**

CCA Data Management

from Personal Software

More powerful system with 100 page manual and many options.

\$79.95 (add \$3. shipping)

GAMES

TRS-80 Opera Theatre Magnificent sound! by Richard Taylor. \$9.95

Alien Invasion by Roy Niederhoffer. \$9.95

X-Wing II by Chris Freund. Level II, 16K \$9.95

Talpan by Art Canfill. Level II, 16K \$9.95

* **Sargon II** by Dan and Kathe Spracklen. Level II, 16K \$29.95

Amazin' Mazes by Robert Wallace. Level II, 16K \$7.95

Android Nim by Leo Christopherson. With sound. Level II, 16K \$14.95

Bee Wary by Leo Christopherson, with sound. Level II, 16K \$14.95

9 Games for Preschool Children by George Blank. Level II, 16K \$9.95

Space Battles by Level IV, Level II, 16K Tape or 32K Disk, Tape-\$14.95, Disk-\$19.95

Star Trek 111.4 by Lance Micklus Level II, 16K \$14.95

Adventures on Tape by Scott Adams. Level II, 16K. Choose one: Adventureland, Pirate's Cove, Mission Impossible, The Count, VooDoo Castle, Strange Odyssey, Pyramid of Doom, and Fun House-\$14.95 each. Adventure Sampler, 16K tape, \$5.95

Adventures on Disk by Scott Adams. 1) Mission Impossible, Pirate's Cove, Adventureland; or, 2) VooDoo Castle, The Count, Strange Odyssey. Either set, \$39.95.

Pork Barrel by George Blank. Level II, 16K \$9.95

Mean Checkers Machine by Lance Micklus. Level II, 16K; tape, \$19.95; disk \$24.95

Kriegspiel by Ron Potkin. Level II, 16K, \$7.95

Galactic Empire and Galactic Trader (a sequel) by Doug Carlston. Level II, 16K, \$14.95. Both on disk, 32K, \$29.95.

ST-80* Smart Terminal Communications Program

CONTROL key, ESC key, REPEAT key, a RUN key, and a functioning BREAK key. List incoming data on your lineprinter. Level II, 16K

Reprogram RS232-C from keyboard. on tape **\$49.95.**

*A trademark of Lance Micklus, Inc.

Original Adventure by Microsoft. 32K, 1 disk \$29.95.

Pigskin (Football) by Acorn Software. Level II, 16K \$9.95

PERSONAL

Typing Tutor by Roger Robitaille, Sr. Level II, 16K \$19.95

Secrets of the Tarot by John T. Phillip. Level II, 16K \$9.95

Advanced Personal Finance by Lance Micklus for 32K disk systems \$24.95

I Ching by John T. Phillip. Level II, 16K \$7.95

UTILITIES

T-Short by Web Associates. Level II, 16K \$9.95

File Manager 80 by Nepenhe. \$49.95 32K

Directory 16K Disk \$9.95

Automated Disk Directory \$14.95 32K Disk. Requires NewDOS.

Spool Print ASCII files \$19.95 (Will not work with NewDOS.)

STAD Trace and Debug Monitor for tape and disk systems 16, 32, and 48K on one tape. \$24.95

NEWDOS by Apparat \$49.95

NEWDOS+ by Apparat \$99.95

VTOS 3.1 by Randy Cook with 100 pp Manual \$75. Manual alone \$30. With BASIC \$99.

RSM2 by Small Systems Software. Level II, 16K \$26.95

RSM2D by Small Systems Software. Disk for 16 through 48K (all in one) \$29.95

KVP by Lance Micklus. Tape-\$29.95; Disk-\$34.95

SUPPLIES

Diskettes Dysan, (premium quality) box of 5 -\$29.95 plus \$1.00 shipping; nationally known brand, box of 10 - \$39.95 plus \$2. **Diskette**

ST-80D* (Enhanced Disk Version) adds:

Transmit any type of TRS-80* ASCII file, including BASIC programs stored in ASCII format, and most BASIC data files. ST-80 D has been used on a variety of timesharing systems. For 32 K disk systems, on disk, **\$79.95.**

BUSINESS

Inventory System II.3 by M. Kelleher. Improved version, \$79.95

Inventory 'S' by Roger W. Robitaille, Sr. Level II, 16K Tape -\$24.95; 32K Disk, (with invoicing) \$59.95.

Payroll by Stephen Hebler. For disk systems. 32K \$59.95

Accounts Receivable II by S. Hebler. 32K disk systems \$79.95

Mail List II by SBSG 32K disk systems \$99.95

Small Business Bookkeeping II by R. W. Robitaille, Sr. Level II, 16K. With journal -\$36.95 disk, \$31.95 tape. \$29.95 disk, \$24.95 tape.

SPECIAL PURPOSE

Electric Pencil by Michael Shrayar. Powerful machine language word processing system. Level II, 16K tape - \$100; Disk version - \$150

Level III BASIC by Microsoft. \$49.95

Level I In Level II by Apparat. Level II, 16K \$15.00

Fortran by Microsoft. 32K - 2 Disks. New low price \$150.00 add \$5. shipping

RX-Basic Cross Reference-XREF-RENUMX. by Lance Micklus RX (disk, 32K) \$24.95; XREF, L II, 16K \$19.95; RENUMX, L II 16K, \$24.95; RENUMBER, \$7.95

BOOKS

Z-80 Software Gourmet Guide and Cookbook. from Scelbi \$14.95 plus \$1 postage

TRS-80 Disk and Other Mysteries, by Harvard Pennington, \$19.95 plus \$1 handling

NEW VTOS 3.1

Randy Cook (add \$3. shipping)

With 100 page manual **-\$75.**

With extended BASIC and manual **-\$99.**

Manual (separately) **-\$30.**

APL 80 by Phelps Gates

APL for the TRS-80* at a bargain price! Level II, 16K, \$14.95 or disk version with SAVE and LOAD and printer output, plus 4 work spaces of self-teaching lessons, plus **APL: An Interactive Approach** for only \$49.95.

MICRO TAX

Time saving programs help you with your 1980 income tax. **Cassette:** Micro Tax I, \$25.; Micro Tax II, \$35.; Micro Tax III, \$50.

Add \$2. shipping and handling.

*TRS-80 is a trademark of Radio Shack and Tandy Corp.

The Dirt-Cheap Bootstrap

More Notes on Bringing Up a Microcomputer

Albert S Woodhull
RFD 2, Enfield Rd
Amherst MA 01002

How do you take the very first steps into learning about microprocessors? An article by Sol Libes ("Notes on Bringing up a Microcomputer," January 1978 BYTE, page 162) described a procedure for the initial testing of a homebrew microcomputer which uses simple procedures to determine whether or not address and control signals are functioning properly. The procedures described are effective, but in order to use them you need a way to load some programs into memory.

If you are building a kit or following a complete microcomputer design, then the details of input and output interfacing will be provided for — a bootstrap program will either be available in read-only memory or can be easily entered from a front panel. But suppose you are just feeling your way along, as I did. I had obtained an 8080A chip set through Intel's University Program, but I had no intention of building a real computer. I had full access to an Altair and an IMSAI at the college where I teach; I wanted only to learn a little about how the hardware worked. I certainly did not want to spend either

the money or the time to imitate the Altair's front panel. The following is a description of how I solved this problem in an economical way.

To set the stage: I had the 8080A microprocessor interfaced with the 8224 clock generator/driver device and 1 K bytes of programmable memory. I had thirty-two light-emitting diodes (LEDs), driven by simple emitter-follower transistor buffers, which indicated the state of the bidirectional data bus, the address bus, and the decoded status signals. Three problems seemed important:

- I needed to be able to single-step the processor so that the light-emitting diodes would show more than a meaningless blur.
- I needed a way to transfer data from the outside world to memory.
- I needed some kind of keyboard or switch panel for entering data.

Single-Stepping

The 8080A is a dynamic device. This means that you can't slow it down to human speed by slowing its clock signal. The 8080A can, however, be made to enter a *wait*

state in which it essentially does nothing at high speed. While in the wait state, the processor uses the clock signal to keep its internal registers refreshed, but does not change its state.

To single-step through a program to make the computer perform each operation only at my command, I needed to be able to hold the processor in a wait state. The processor would stay in this wait state until I asked it to take a step; it would then immediately return to the wait state. As shown in the schematic diagram of figure 1, it was very easy to do this with only a single flip-flop.

The output of the flip-flop (half of a 7474 dual D edge-triggered type) was connected to the RDYIN line on the 8224 clock generator and driver. This line initiates a wait state when it is pulled low. Three inputs of the 7474 were used. The D (data) line was connected to ground. The clock input on the 7474 was driven by the SYNC output of the 8080A. Finally, a simple pulse generator drove the SET input to the flip-flop.

The operation of this circuit resembles that of a person whose reflexive response to the sound of an

COMPUPRO™ CONTINUES TO DELIVER.

Whether it's memory, motherboards, I/O boards, enclosures, or any of our family of products, CompuPro™ delivers what you want at prices you can afford.

Looking for memory? Our boards are fully static, low power, run at 4 or 5 MHz, support a number of popular busses, include a 1 year limited warranty, and generally come in 3 configurations to suit your exact needs. For lowest cost, choose an "unkit" with sockets and bypass caps pre-soldered in place for easy assembly. When you can't wait to get going, order one of our assembled versions. For critical systems, specify boards qualified under our **Certified System Component (CSC)** high reliability program. These boards are extensively tested, burned in for at least 200 hours, and are immediately replaced in event of failure within 1 year of invoice date.

Looking for other peripherals? We mix leading edge technology, design savvy, and volume buying to deliver the right product at the right price. See our list below for pricing.

Memory name	Buss & Notes	Unkit	Assm	CSC
8K Econoram* IIA	S-100	\$149	\$179	\$239
16K Econoram IV	S-100	\$289	\$339	\$429
16K Econoram VIIA-16	S-100	\$299	\$349	\$439
24K Econoram VIIA-24	S-100	\$419	\$499	\$605
16K Econoram IX-16	Dig Grp	\$319	\$379	n/a
32K Econoram IX-32	Dig Grp	\$559	\$639	n/a
32K Econoram X	S-100	\$549	\$669	\$789
32K Econoram XI	SBC/BLC	n/a	n/a	\$1050
16K Econoram XIII A-16	S-100 (1)	\$349	\$419	\$519
24K Econoram XIII A-24	S-100 (1)	\$469	\$539	\$649
32K Econoram XIII A-32	S-100 (1)	\$579	\$699	\$849
16K Econoram XIV	S-100 (2)	\$299	\$359	\$459
16K Econoram XV-16	H8 (3)	\$329	\$395	n/a
32K Econoram XV-32	H8 (3)	\$599	\$729	n/a

*Econoram is a trademark of Godbout Electronics

- (1) Compatible with all bank select systems (Cromemco, Alpha Micro, etc.); addressable on 4K boundaries.
- (2) Extended addressing (24 address lines). Single block addressable on 4K boundaries.
- (3) Bank select option for implementing memory systems greater than 64K.

16K DYNAMIC RAMS 8/\$87.20!

Perfect for memory expansion in a number of machines (TRS-80** Model I and Model II, Exidy Sorcerer, Heath H89, Apple, etc.), and you can't beat our price: 8 high speed chips for \$64! Add \$3 if you'd like 2 dip shunts plus TRS-80** programming instructions to expand memory. These are 250 ns (4 MHz), dynamic RAMs... but quantities are limited, so hurry is you want to take advantage of this super deal.

**TRS-80 is a trademark of the Tandy Corporation.

PASCAL/M™ + MEMORY SPECIAL

PASCAL can give a microcomputer with CP/M more power than many minis. For a limited time only, you can buy an assembled Econoram X, plus our totally standard Wirth PASCAL/M™ 8" diskette, for \$799 (regular combined price, \$999). Includes manual, plus Wirth's definitive book on PASCAL; specify Z-80 or 8080/8085 version. Diskette is also available separately for \$350.

2708 EROM BOARD \$85 unkit

4 independently addressable 4K blocks, with dip-switch selectable jump start built right into the board. Includes all support chips and manual, but does not include EROMs.

**THESE PRODUCTS ARE GENERALLY
AVAILABLE FROM YOUR LOCAL
COMPUTER STORE.**

ACTIVE TERMINATOR BOARD \$34.50 kit

Plugs into any S-100 motherboard (although ours don't need it) to reduce ringing, crosstalk, noise, and other buss-related problems.

THE GODBOUT COMPUTER BOX

\$259 desktop, \$299 rack mount (introductory price)

The ideal home for your computer. With fan, dual AC outlets and fuseholder, power switch, heavy-duty line filter, black anodized front panel (with textured vinyl painted cover for desk top version); pre-drilled base accepts our high-performance motherboards or similar types by Vector, California Digital, and others. Rack mount version includes slides for easy pull-out from rack. This functional, versatile, and handsome enclosure does justice to the finest computer systems.

HIGH-PERFORMANCE S-100 MOTHERBOARDS

6 slot: \$ 89 unkit, \$129 assm 12 slot: \$129 unkit, \$169 assm
19 slot: \$174 unkit, \$214 assm

Unkits have edge connectors and termination resistors pre-soldered in place for easy assembly. These boards exceed the latest S-100 specs and will work with 5 to 10 MHz CPUs. Includes true active termination, grounded Faraday shield between all buss signal lines, and edge connectors for all slots.

S-100 MEMORY MANAGER BOARD \$59 unkit \$85 assm \$100 CSC

Add bank select and extended addressing to older S-100 machines (Altair, IMSAI, Sol, and others). Use with our new extended addressing boards, or retrofit our high density Econorams for use with the Memory Manager to get added memory space for your computer.

MULLEN S-100 EXTENDER BOARD \$49 kit

Includes logic probe and general purpose breadboard section. Ideal for troubleshooting and analysis.

3P PLUS S "Interfacer II" \$199 unkit \$249 assm \$324 CSC

Incorporates 1 channel of serial I/O (RS-232 with full handshake), along with 3 full duplex parallel ports plus a separate status port. The parallel section uses Tri-State (tm National Semiconductor) octal latches for latched data, input and output with 24 mA drive current, attention/enable/strobe bits for each parallel port (with selectable polarity), interrupts for each input port, and separate connectors with power for each channel.

2S "Interfacer I" S-100 I/O BOARD \$199 unkit \$249 assm \$324 CSC

Dual RS-232 ports with full handshake; use EIA232C line drivers and receivers (1488, 1489), or current loop (20 mA), or TTL signals on both ports. On-board crystal timebase with independently selectable Baud rates for each port (up to 19.2 Kbaud). Hardware UARTs don't tie up the CPU.

CompuPro™

from **GODBOUT**
ELECTRONICS

Bldg. 725, Oakland Airport, CA 94614

TERMS: Cal res add tax. Allow 5% for shipping, excess refunded. VISA®/Mastercharge® call our 24 hour order desk at (415) 562-0636. COD OK with street address for UPS. Prices good through cover month of magazine.

The subLOGIC FS1 Flight Simulator*

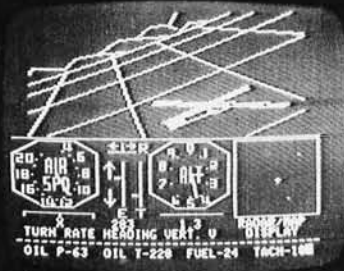

is just one application of our fine graphic software.

Other applications can be yours!

Choose from a coordinated software and hardware collection to fit your graphic needs...

SOFTWARE

A23D1 animation package for the Apple II (\$45 on cassette, \$55 for disk).

8080/Z80 3D package for most S100 systems (\$41 on tarbell cassette or paper tape, \$51 on 5" North Star disk, or \$52 on 8" CPM disk).

HARDWARE (\$100)

Biotech CGS 808 \$399
Matrox ALT-256 \$395
Matrox ALT-512 \$595

Write or call for an informative catalog describing these and other graphic products and their easy use in your applications.

Most subLOGIC software is at your dealer's. If he doesn't stock it, order direct from subLOGIC. Add \$1.25 for UPS or \$1.75 for first class mail. Visa and Mastercharge accepted.

*The FS1 Flight Simulator is available for Apple II and TRS-80 Level I & II for \$25 on cassette.

(217) 359-8482
subLOGIC
Box V, Savoy, IL 61874
The engineering and graphics experts.

Number	Type	+5 V	GND
IC1	7474	14	7
IC2	555	8	1
IC3	7404	14	7

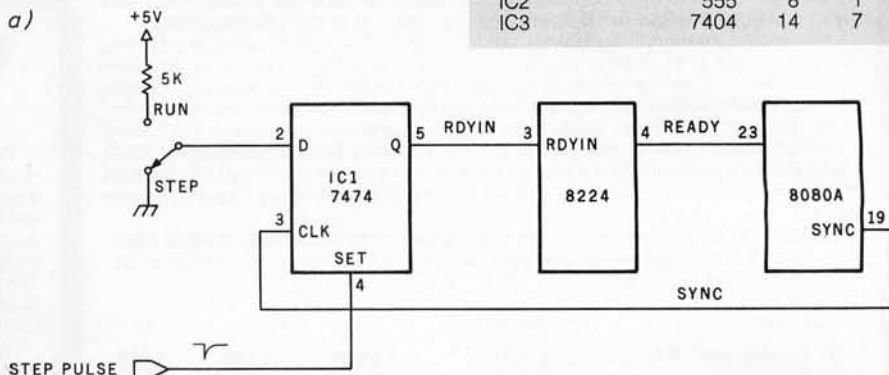

Figure 1a: A single-step mode can be implemented on an 8080A processor by using a flip-flop and the 8080A SYNC signal to clock a low-logic level through to the READY line. This puts the 8080A into a wait state. A very brief pulse to the SET input of the flip-flop ends the wait state until the next SYNC signal.

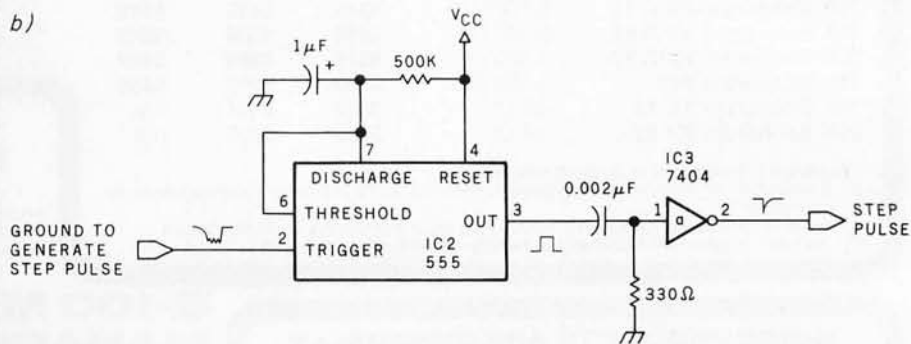

Figure 1b: The very narrow STEP pulse can be generated by a half-monostable circuit, a resistor-capacitor network at the input to a 7400 inverter. The manual switch contact must be debounced by a monostable circuit with a 0.1 to 1 second pulse width, for which a 555 timer is well-suited.

alarm clock is to roll over and turn it off. Normally the processor is in the wait state. A pulse to the SET input of the flip-flop ends the WAIT state, allowing the computer to complete execution of the process that is in suspension. At the very beginning of the processor's next cycle, it will send out a SYNC signal which will again clock the flip-flop output low, and reinitiate the processor wait state.

Getting the Data In

There are two ways an 8080A can access the outside world. IN or OUT instructions generate status signals which can be decoded, along with an 8-bit address, to activate input buffers or output latches. Alternatively, a memory address that is not actually used by memory devices can be decoded, along with read-from-memory or write-to-memory status signals. This can be used to activate a

memory-mapped buffer or latch. If a limited amount of memory and a small number of I/O (input/output) ports are to be addressed, the decoding can be ambiguous—some of the address lines may be ignored.

For bootstrapping purposes I took this to the limit: I arranged a switch to allow all memory-read signals to activate an input buffer, regardless of the state of the address lines. The principle is illustrated in the schematic diagram of figure 2. In the LOAD position of the switch, the real memory is never read, but memory-write signals are still capable of performing their normal function. When the processor begins an instruction cycle, it reads a byte from "memory" which is interpreted as an instruction. It makes no difference to the processor if the byte actually originates on the front panel.

This arrangement makes it possible

Is it Dungeons and Dragons or Dungeons and Dragons?

Did you read about the fellow who became so enchanted playing D & D, he disappeared for a month?

Chances are, when you play the **Dunjonquest™** version, the greatest of all the role-playing fantasies, you'll be able to hold on to reality just a little better.

You're the hero. Enter into the Dunjonquest "Temple of Apschai" and into the greatest fantasy adventure you've ever experienced. The Temple has over 200 rooms and catacombs in which lurk more than 30 kinds of monsters and beasts ready to do you in—in real time—before you can reach any of the 70 or so treasures waiting for the hero. You may spend days, weeks, months... the rest of your life... striking at the forces of evil, or running from them, or calling on powers you can never completely understand. Always, always demonstrating in varying degrees your strength, constitution, dexterity, intelligence, intuition, the force of your ego.

Unlike chess or bridge or monopoly, this role-playing game—like other good role-playing games—is an **experience** rather than a game: it is not played so much as it's lived or experienced. Your alter ego goes forth into the world of demons and darkness, dragons and dwarves. Your character will do whatever you want him (or her or it) to do.

"The Temple..." comes complete with a superbly illustrated 56-page rule book and cassette program,

designed to operate with the Level II 16K TRS 80, the PET 32K or the Apple II 48K (Microsoft) computer. Only \$24.95 complete, including shipping and handling on orders placed within the next 30 days. (Apple disk available for \$29.95).

Dunjonquest's "The Temple of Apschai" is **guaranteed** to be the best version of Dungeons and Dragons/Dungeons and Dragons. It's a product of the two guys who are Automated Simulations: Jim Connelley and Jon Freeman. Jim is a Dungeon Master, running continuous D & D campaigns. He's been a data processing professional with Westinghouse, GTE Sylvania, Logisticon... an expert in computer-based math modeling and in simulation of complex phenomena. Jon is a game player, designer and author. He's a frequent contributor to *Games* magazine;... and this brings us to our unbelievable offer:

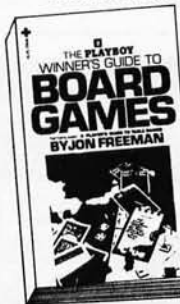

FREE: The Playboy Winner's Guide to Board Games the bestselling paperback by our own Jon Freeman. How to win at Monopoly, Scrabble, Dungeons and Dragons and almost 100 other board games. **Order your Dunjonquest Temple of Apschai now, get the book free... and you keep it even if you don't choose to keep the guaranteed Dunjonquest.**

As we said, **guaranteed**: Guaranteed to be the best version; guaranteed that you'll be happy with it. Order now, use it for two weeks. If you don't enjoy completely this fantasy adventure experience that goes beyond all others, send it back to us. We'll refund your money in full; no questions asked.

Master Charge or Visa card holders: charge "The Temple of Apschai" to your credit card. Just call our toll free number: (800) 824-7888, operator 861 (In California, call operator 861 (800) 852-7777. In Hawaii and Alaska, operator 861 (800) 824-7919) and you can begin enjoying your D & D game in days. Or send your check for \$24.95* to



Automated Simulations

Dept. K3
P.O. Box 4232
Mountain View, Ca. 94040

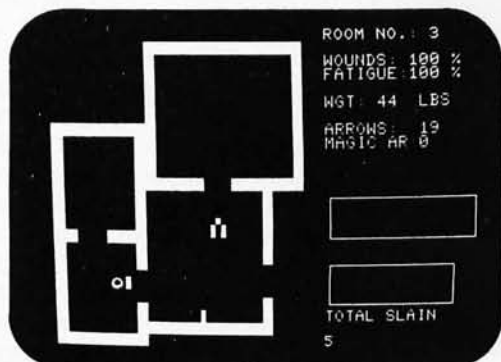

Actual photo of screen during a Dunjonquest game. In Room 3 in the Temple of Apschai, our hero observes two treasures unattended by dragons, monsters or demons... for the moment. He is completely free of wounds; he is not at all fatigued. He carries 44 pounds of armor and 19 arrows in his quiver. He has already slain five demons. Will he capture the treasures before moving on... or before the forces of darkness intercept him?

*California residents, please add 6.5% tax.

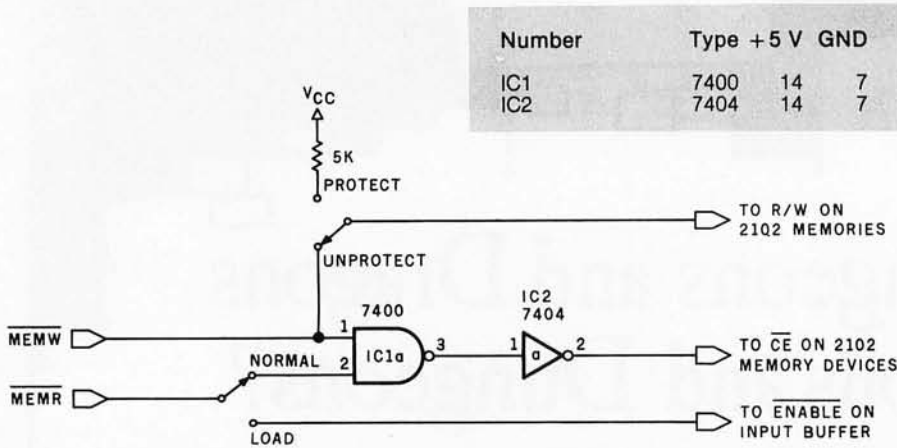

Figure 2: The LOAD/NORMAL switch routes the $\overline{\text{MEMR}}$ signal to an input buffer instead of to the memory, thus enabling the operator to control the processor by entering instruction codes from the outside. Also shown is another switch which can protect memory from inadvertent writing during debugging.

to move a byte of data from the front panel to the real memory by first setting up the code for a *move immediate data to memory* instruction (MVI M) on the panel, allowing the processor to execute a single step, and then setting up the value to be loaded on the panel. A second single step will read the data from the panel input,

and a third step will then write that data into a memory location.

The particular memory location must be specified somehow, so several additional bytes of instructions must have been *previously* entered. A few simple additions to the hardware already described make it necessary to do this only once, even if

many bytes are to be loaded into memory. A look at the computer to human interface should come first, however.

Cheap Keyboard Substitute

Figure 3 illustrates the ultimate in low-budget input devices. I took a scrap of copper-clad circuit board, scored it with a hacksaw into two rows of ten copper-bearing squares each, and soldered a length of wire to each square. Eight pairs of wires went to the inputs of simple latch circuits made by cross-connecting 7400 NAND gates; the other four pads on the circuit board were available for other controls. Light-emitting diodes (LEDs) indicated the state of each of the eight bits. A probe made from a defunct ball-point pen could be used to momentarily ground any of the pads.

In this way I could set up any desired combination on the latches; their outputs were in turn connected to the input port of the computer. One of the extra pads was connected to the single-step pulse generator mentioned earlier, via a debouncing circuit, and another was connected to the processor RESET line.

A Few Extras

Some additions to the elementary circuits described above were incorporated into the final version. The first of these is a trick I call "double addressing." An input port is physically just a buffer; there is no reason why a single physical port cannot have multiple logical identities.

I set up some logic gates to decode the input status signal and an address, along with an additional gate, to allow either the result of this decoding or a memory-read signal from the LOAD switch to activate the input buffer. The LOAD mode is used to load a simple bootstrap program. The bootstrap routine specifies a starting address for the program to be loaded, gets the data from the input port, moves it to memory, increments the pointer to memory, and then loops back to get another byte from the input. Once this bootstrap program has been loaded, the MEMR signal is switched back to the real programmable memory, but an IN instruction can still read the input port.

Text continued on page 148

TRS-80, PET, APPLE, SORCERER Ham Interface Systems



- Send & Receive RTTY / CW.
- Complete Hardware & Software Package.
- Extensive User Manuals.
- From \$129.

Write or call for complete catalog



MACROTRONICS, inc.®

1125 N. Golden State Blvd. / Suite G
Turlock, CA 95380 (A)
(209) 667-2888 / 634-8888

We are experiencing telephone difficulties,
please keep trying.



California residents add 6% tax

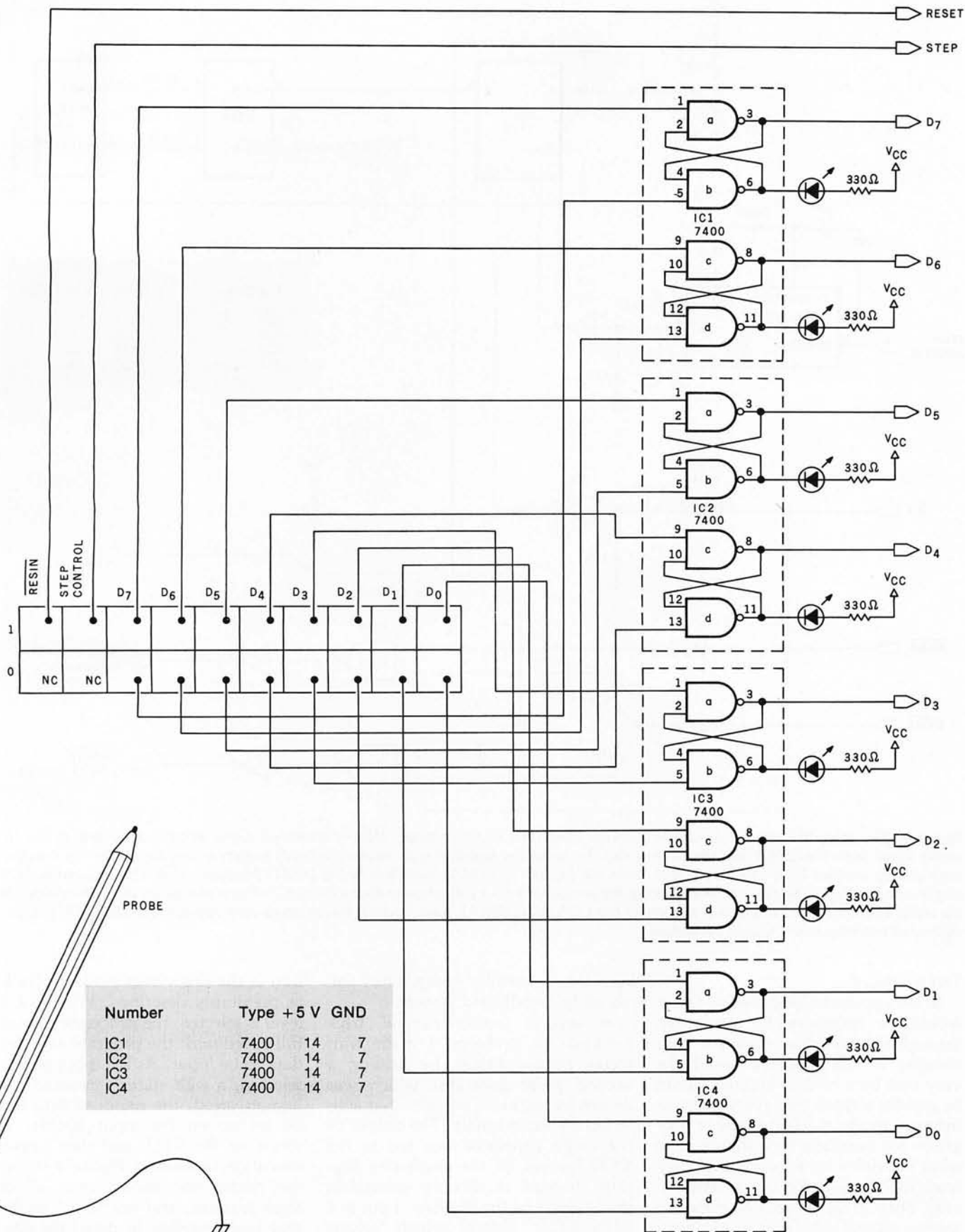

Figure 3: A small scrap of printed circuit board, an old ball-point pen, and some latch flip-flop circuits make a very inexpensive input device. With a little practice, an 8-bit number can be set up as easily and quickly as on a row of toggle switches. The surface of the printed circuit board has been scored to create isolated areas of copper for sensing purposes.

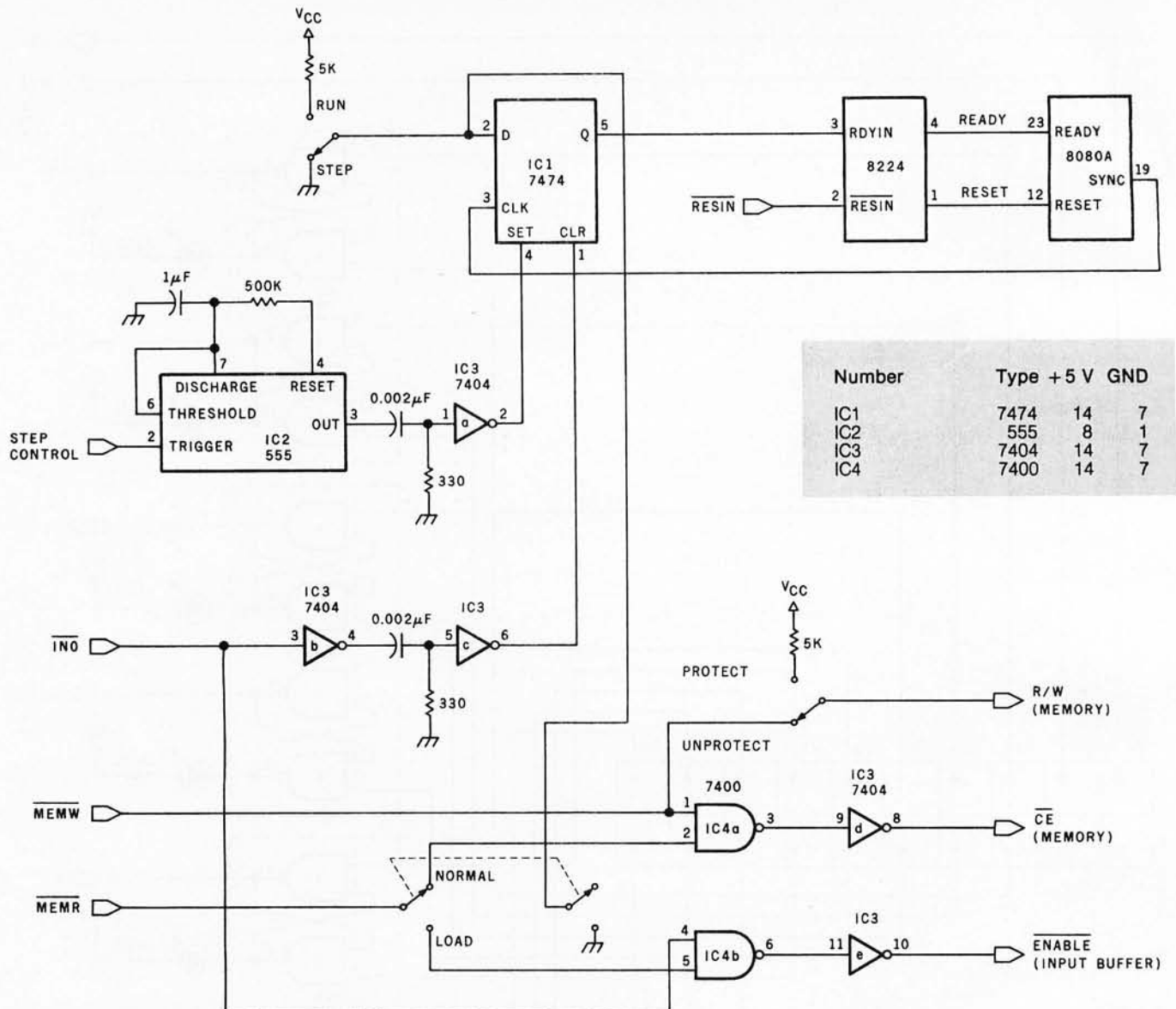

Figure 4: The complete control hardware package described in this article. $\overline{IN0}$ is a control signal produced by getting the \overline{IN} status signal from the 8080A and the address bus. Its orthodox function is to enable the input buffer; in this circuit the input buffer may also be enabled by a \overline{MEMR} signal when the LOAD/NORMAL switch is in the LOAD position. $\overline{IN0}$ also causes the 7474 single-step flip-flop to be cleared, thus forcing the processor into a wait state so that a human operator can set up the desired data on the input latch. Note the additional section of the LOAD/NORMAL switch which forces single-step operation in the LOAD mode, when full machine speed would be useless.

Text continued:

In the apparatus described so far, it would be necessary to single-step through the bootstrap program loop because at full machine speed the very first byte of data entered would be rapidly written into every possible memory location. Most monitor programs for handling such inputs have some provision for ensuring that they read each keystroke on a terminal only once. This is usually done by using a second input port as a control port which signals when new data is available. The hardware and software required for this would have

been inconveniently complicated for my early breadboard system.

A second unconventional trick avoided the problem. I made wait states programmable by adding a second pulse generator which was driven by the same decoder that activated the input buffer. The output of this pulse generator was fed to the RESET input on the single-step flip-flop. Instead of directly grounding the D input on the flip-flop, I put in a RUN/STEP switch which selects either a logic 1 or a logic 0 level for this input.

When the 0 level is selected, opera-

tion in the single-step mode proceeds as previously described. When the 1 level is selected, the processor runs at full speed until the program calls for data to be input. As the input port is selected, a wait state is initiated. At human speed, the required data can be set up on the input latches. A touch on the STEP pad then causes execution to resume. Figure 4 shows the circuit that incorporates all of these features, and example 1 in the text box describes in detail the procedure for loading the bootstrap program.

Text continued on page 152



When your Data Demands Security.

ENCODE/DECODE: The Software Security System for CP/M* & TRS-80# DOS

Let's face it, there is information which just isn't meant for everyone who uses or has access to your computer. Consider payroll or tax records. Until now, the only way to secure these and other valued or privileged records meant either "pulling the plug" or locking the discettes in a safe. Who wants to run to the safe each time an update needs to be made? At last a simple, effective and convenient method of data security is available—ENCODE/DECODE.

ENCODE/DECODE is a complete software security system for your micro/mini computer. ENCODE/DECODE can provide both the level of security and privacy you desire without loss of ON-LINE immediate access to data. ENCODE/DECODE is a sophisticated coding program which transforms data stored on disc into coded text which is completely unrecognizable. When it's time to access the file, it is decoded and ready for use. This means that data can be on-line and current with all your other files, yet only the user defined combination can retrieve it.

Multiple Security levels: Using ENCODE/DECODE you can easily maintain several layers of security through the use of separate combinations. This means that each file can have its own 'password' allowing only those with the 'password' access to the file.

ENCODE/DECODE uses a complex coding algorithm which supports over 987,000,000 possible combinations thus making accidental or 'exhaustive search' methods of decoding virtually impossible. Briefly, an encoded data file will appear scrambled and completely unintelligible until you decode it. Both encoding and decoding require the user defined combination.

Uses for ENCODE/DECODE are unlimited. Below are a few examples:

data bases	general ledger	inventory
payroll files	correspondence	accounts payable/
programs	tax records	receivable
text	mail lists	& more

ENCODE/DECODE is available in two versions. ENCODE/DECODE I provides a level of security suitable for normal use. ENCODE/DECODE II provides enhanced security for the most demanding needs. Both versions come supplied on discette and with a complete user's manual.

ENCODE/DECODE I : \$ 50.00
ENCODE/DECODE II: \$100.00
manual for above: \$ 15.00

Minimal system requirements: 24K CP/M; 16K disc for TRS-80

formats: CP/M 8" SOFT SECTORED, NORTHSTAR CP/M AND TRS-80 DOS

All Orders and General Information:
SUPERSOFT ASSOCIATES
P.O. BOX 1628
CHAMPAIGN, IL 61820
(217) 344-7596

Technical Hot Line: (217) 384-0847
(answered only when technician is available)

*CP/M REGISTERED TRADEMARK DIGITAL RESEARCH
#TRS-80 TRADEMARK TANDY CORP

OEM and dealer inquiries invited, overseas orders add \$5.00 shipping.

Circle 94 on inquiry card.

Example 1 Cold Start Bootstrap

The following sequence of operations is used with the hardware system described in the text to load a program when power is supplied to the computer:

1. Set LOAD/NORMAL switch to LOAD.
2. Momentarily ground the RESIN line. This clears the program counter and ensures that the processor will interpret the first byte it reads as an instruction.
3. Set up the input latch with the binary data 00100001. This is hexadecimal 21, the op code for a load-immediate data into the HL register pair (LXI H) instruction. When ready, ground the STEP line.
4. The processor will now expect a second and third byte for the LXI H instruction. These bytes will be loaded into the L and H registers and will act as a pointer to a particular memory address. To start at address 0000, set up all zeros on the input and STEP twice.
5. Set up the op code for the load immediate data into a memory location pointed to by the HL pair (MVI M) instruction, hexadecimal 36, then STEP by grounding the line.
6. The processor will now expect a byte of data. Set up hexadecimal DB on the latches. This is the code for the IN (receive input) instruction. Then STEP twice, once for the processor to read the data, and once for it to write the data into the memory.
7. Now set up hexadecimal 23 and STEP. This is the op code for the INX H instruction. This operation increments the address stored in the L and H registers and prepares the processor to write a byte to the next address in memory.

Only the last three operations of this sequence must be repeated to load additional bytes of data into the memory. Furthermore, only six more repetitions of steps 5, 6, and

7 are needed to complete the loading of the program given as listing 1.

After you enter this program, reset the program counter by grounding the RESIN line. Switch the LOAD/NORMAL control to NORMAL. The single-step mode can be used to verify that the program has been loaded properly, and then the full-speed run mode can be entered. Loading additional data into memory requires only that you set up the data on the input device and ground the STEP line. With an almost imperceptible flicker of the light-emitting diodes (LEDs), the data is read from the input and written into the memory. The processor again waits for another byte.

Example 2 Examination of a Memory Location

To examine a particular location follow this procedure:

1. Set the LOAD/NORMAL switch to LOAD.
2. Momentarily ground the RESIN line.
3. Enter hexadecimal C3, the code for a JMP, then STEP.
4. Enter the low byte of the desired address, then STEP.
5. Enter the high byte of the desired address, then STEP.
6. Setting the LOAD/NORMAL switch back to NORMAL will put the data at the desired location on the data bus, thus displaying it on the data LEDs.

After examining a location, a STEP will start execution from that location. You can then conduct another examine operation to show a new location, or the examine-next procedure of example 3 can show the next location.

Example 3 The Examine-Next Function

To look at a program or data in memory without executing it, first examine the first byte in the

desired memory segment, then do the following:

1. Set the LOAD/NORMAL switch to LOAD. Do not ground RESIN.
2. Set up all zeros on the input latch. This is the code for a no operation (NOP) instruction.
3. STEP, then switch to NORMAL. The next byte in memory will be displayed on the data LEDs.

This procedure can be repeated as desired. Note, however, that strange things can happen if you start execution while examining a byte which is the second or third byte of a multibyte instruction. This error of starting in the wrong place is also possible with most conventional front panels.

Example 4 Temporary Patches

When a program contains loops that are repeated many times, single-step debugging can be simplified by substituting instructions. For example, a subroutine that generates eight cycles of 2400 Hz audio to record a logic 1 bit on magnetic tape is shown in listing 2.

To verify that this program worked properly, you would not want to single-step through the inner loop 416 times! You might step through it once, but the next time you came to the JNZ instruction, you could use the LOAD function to make the processor see three successive NOPs. Alternately, you might change the cycle counting and timing bytes at locations 0102 and 0104 to the value 01. Since the LOAD substitution does not actually alter memory contents, this procedure can also be used for a program stored in read-only memory. There is no need to go back and undo patches after tracing the program. In these respects the LOAD function of this simple control system is more versatile than most conventional front panels. If a permanent patch is needed, you can use the LXI H and MVI M instructions.



Please send your free software catalog.

(Check which software is of particular interest)

C COMPILER. Optimized native code for VAX 11/780, PDP-11, LSI-11, Z80, 8085, 8080. Full C language as defined in Kernighan and Ritchie, with comprehensive portable library. Cross compilers available. Runs under VMS, IAS, RSX-11D, RSX-11M, RSTS/E, RT-11, UNIX, Idris, CDOS, CP/M. From \$500.

IDRIS OPERATING SYSTEM. System calls and file system identical to UNIX V6, including pipelines. Utilities include shell, editor, assembler, loader, archiver, compare, copy, grep, etc., plus system utilities for file system maintenance. Runs on LSI-11, PDP-11. From \$1000.

PASCAL COMPILER. Optimized native code for VAX 11/780, PDP-11, LSI-11, Z80, 8085, 8080. Full Pascal language as defined in Jensen and Wirth, with standard library. Includes C compiler and portable library, permitting intermixed C and Pascal. Cross compilers available. Runs under VMS, IAS, RSX-11D, RSX-11M, RSTS/E, RT-11, UNIX, Idris, CDOS, CP/M. From \$750.

Idris is a trademark of Whitesmiths Ltd.
UNIX is a trademark of Bell Laboratories.
CP/M is a trademark of Digital Research Co.

VMS, RSX-11, RT-11, RSTS/E, VAX,
PDP-11, LSI-11 are trademarks of Digital
Equipment Corporation.

Name _____

Company _____

Street _____

City _____ State _____ Zip _____

Whitesmiths, Ltd.
Software for grownups.
(212) 799-1200
P.O.B. 1132 Ansonia Station, New York, N.Y. 10023

Listing 1: Program instructions which are loaded into the 8080 memory by manual means, and are then used to load further memory locations more quickly.

Hexadecimal Data Loaded	Instruction Mnemonic	Explanation
DB 00	IN	Input Input port address (hardware dependent)
77	MOV M,A INX H	Copy data from accumulator to memory
23		Increment HL, the memory pointer
C3 00 00	JMP	Jump Jump address, low byte Jump address, high byte

Listing 2: A routine for the 8080 which can record a logic 1 bit on a cassette tape by generating eight cycles of a 2400 Hz audio signal.

Address	Label	Mnemonic	Explanation
0100	MARK	XRA A	Set accumulator to zero
0101		MVI B 10	Set up a counter to count 16 half cycles
0102	HALFCY	MVI C 1A	And another counter to time 26 loops
0103		OUT 00	Then output to port 0
0104		DCR C	Countdown the timer
0105	TIMELOOP	JNZ TIMELOOP	And stay in the loop until counter is zero
0106		07 01	
0107		CMA	Complement the accumulator
0108		DCR B	Countdown half cycles
0109		JNZ HALFCY	And send more until cycle counter is zero
010A		0	
010B		01	
010C		RET	Then return to main program
010D			
010E			
010F			
0110			

Text continued:

Additional Applications

The LOAD mode permits direct control of the computer at any time. Most of the functions of the front panel on an IMSAI or Altair can be simulated by causing the processor to execute instructions loaded directly from the crude printed-circuit-pad "front panel." For example, executing a JMP instruction is equivalent to the *examine* function of the usual front panel. *Examine next* is implemented by single-stepping a no-operation (NOP) instruction. A program can also be temporarily patched during single-step debugging to break out of a loop, or to try an alternative instruction. Examples 2, 3, and 4 in the text box explain these functions in more detail.

Evolution of the System

While developing the circuits I have described, I became hooked on microprocessors. What started out as a breadboard project is now a computer, but I have spent less money along the way than is ordinarily paid for a system of less capability.

To encourage others who might wish to follow a route similar to mine, I want to emphasize that all of the effort and material that went into my first experiments were useful in the larger system that grew from it. The single input port that served my printed circuit board input device was later shared by an ASCII keyboard and a cassette recorder.

The addition of a single *output* port made possible the use of software timing in a routine to generate audio tones for recording programs on tape. Another bit of the same output port can drive a printer in serial mode; again, software timing can be used.

The first 256-byte block of read-only memory that I added was adequate to hold all of the programs that I needed to read cassette tapes. During the few weeks it took me to develop those programs, not wishing to lose the programs by removing power from the programmable memory, I connected an old car battery to the memory to keep it alive.

I have now reached the point of connecting commercial S-100 cards to my system. Because I have built it and know the function of every wire, it is easy to make minor modifications when a control signal is needed for interfacing a new device. ■

ASCII encoded keyboards as low as \$65*



The RCA VP-601 keyboard has a 58 key typewriter format for alphanumeric entry. The VP-611 (\$15 additional*) offers the same typewriter format plus an additional 16 key calculator type keypad.

Both keyboards feature modern flexible membrane key switches with contact life rated at greater than 5 million operations, plus two key rollover circuitry.

A finger positioning overlay combined with light positive activation key pressure gives good operator "feel", and an on-board tone generator gives aural key feedback.

The unitized keyboard surface is spillproof and dustproof. This plus the high noise immunity of CMOS circuitry makes the VP-601 and VP-611 particularly suited for use in hostile environments.

The keyboards operate from a single 5-volt, DC power supply, and the buffered output is TTL compatible. For more information contact RCA Customer Service, New Holland Avenue, Lancaster, PA 17604.

Or call our toll-free number: 800-233-0094.

*Optional User Price. Dealer and OEM Prices Available.

THE ORIGINAL MAGAZINE FOR OWNERS OF THE TRS-80™* MICROCOMPUTER

SOFTWARE FOR TRS-80™ OWNERS

H & E COMPUTRONICS INC.

MONTHLY NEWSMAGAZINE FOR TRS-80™ OWNERS

MONTHLY NEWSMAGAZINE Practical Support For Model I & II

- PRACTICAL APPLICATIONS
- BUSINESS
- GAMBLING • GAMES
- EDUCATION
- PERSONAL FINANCE
- BEGINNER'S CORNER
- NEW PRODUCTS
- SOFTWARE EXCHANGE
- MARKET PLACE
- QUESTIONS AND ANSWERS
- PROGRAM PRINTOUTS
- AND MORE

PROGRAMS AND ARTICLES PUBLISHED IN OUR FIRST 12 ISSUES INCLUDE THE FOLLOWING:

- A COMPLETE INCOME TAX PROGRAM (LONG AND SHORT FORM)
- INVENTORY CONTROL
- STOCK MARKET ANALYSIS
- WORD PROCESSING PROGRAM (FOR DISK OR CASSETTE)
- LOWER CASE MODIFICATION FOR YOUR VIDEO MONITOR OR PRINTER
- PAYROLL (FEDERAL TAX WITHHOLDING PROGRAM)
- EXTEND 16-DIGIT ACCURACY TO TRS-80™ FUNCTIONS (SUCH AS SQUARE ROOTS AND TRIGONOMETRIC FUNCTIONS)
- NEW DISK DRIVES FOR YOUR TRS-80™
- PRINTER OPTIONS AVAILABLE FOR YOUR TRS-80™
- A HORSE SELECTION SYSTEM***ARITHMETIC TEACHER
- COMPLETE MAILING LIST PROGRAMS (BOTH FOR DISK OR CASSETTE SEQUENTIAL AND RANDOM ACCESS)
- RANDOM SAMPLING***BAR GRAPH
- CHECKBOOK MAINTENANCE PROGRAM
- LEVEL II UPDATES***LEVEL II INDEX
- CREDIT CARD INFORMATION STORAGE FILE
- BEGINNER'S GUIDE TO MACHINE LANGUAGE AND ASSEMBLY LANGUAGE
- LINE RENUMBERING
- AND CASSETTE TIPS, PROGRAM HINTS, LATEST PRODUCTS COMING SOON (GENERAL LEDGER, ACCOUNTS PAYABLE AND RECEIVABLE, FORTRAN-80, FINANCIAL APPLICATIONS PACKAGE, PROGRAMS FOR HOMEOWNERS, MERGE TWO PROGRAMS, STATISTICAL AND MATHEMATICAL PROGRAMS (BOTH ELEMENTARY AND ADVANCED) ... AND

WORD PROCESSING PROGRAM (Cassette or Disk)

For writing letters, text, mailing lists, etc., with each new subscriptions or renewal.

LEVEL II RAM TEST (Cassette or Disk)

Checks random access memory to ensure that all memory locations are working properly.

DATA MANAGEMENT SYSTEM (Cassette or Disk)

Complete file management for your * TRS-80™

SEND FOR OUR 36 PAGE SOFTWARE CATALOG (INCLUDING LISTINGS OF HUNDREDS OF TRS-80™ PROGRAMS AVAILABLE ON CASSETTE AND DISKETTE). \$2.00 OR FREE WITH EACH SUBSCRIPTIONS OR SAMPLE ISSUE.

* TRS-80™ IS A TRADEMARK OF TANDY CORPORATION

COMPUTRONICS
MATHEMATICAL APPLICATIONS SERVICE™

Box 149 New City, New York 10956

ONE YEAR SUBSCRIPTION \$24

TWO YEAR SUBSCRIPTION \$48

SAMPLE OF LATEST ISSUE \$ 4

START MY SUBSCRIPTION WITH ISSUE

(#1 - July 1978 • #7 - January 1979 • #12 - June 1979 • #18 - January 1980)

NEW SUBSCRIPTION RENEWAL

CREDIT CARD NUMBER _____ EXP. DATE _____

SIGNATURE _____

NAME _____

ADDRESS _____ STATE _____ ZIP _____

*** ADD \$6/YEAR (CANADA, MEXICO) - ADD \$12/YEAR AIR MAIL - OUTSIDE OF U.S.A., CANADA & MEXICO ***



24 HOUR ORDER LINE
(914) 425-1535



PIMS Personal Information Management System



Improve your life style

Learn how you can unleash the power of a personal computer for your own benefit. A ready-to-use data base management program.

SCELEBI Publications

Introduction to Low Resolution GRAPHICS

How to draw lines, circles, squares, rectangles, polygons, and more shapes for business or pleasure.

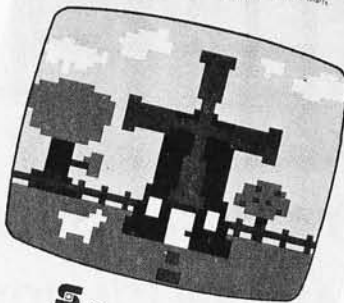

SCELEBI Publications

Personal Information Management System

For business and for pleasure. Increase your personal capabilities . . . save money . . . improve your ability to plan . . . locate important facts quickly. PIMS is a ready-to-use information (data base) management system for computers like the TRS-80, PET, etc. Have your computer manage tax deductions, department store charges, plan your day. Use it to keep your mailing list, do simple accounts receivable and payable. And much more! Includes easy-to-read manual and source listing. Written by the SCELEBI staff.

Only \$9.95 No. 10

Introduction to Low Resolution Graphics

Now you can produce amazing computer graphics — even if you can't draw a straight line. Literally! Learn how to draw lines and shapes, make graphs, draw pictures and even do animations. The simple secrets of how to do all this are contained in this new book by Nat Wadsworth. You'll be able to produce a deck of playing cards . . . a clown that winks . . . a football grid . . . and an animated football game. Also tells how to synchronize computer-generated sounds to your illustrations.

Just \$9.95 No. 65

SERIOUS

Understanding Microcomputers

Accepted as the standard! 300 page easy reading text. Explains exactly how a microprocessor works. Intro to programming in BASIC. Complete glossary.

Just \$9.95 No. 90



Microcomputer Potpourri

A pocket-size reference for the beginner and pro alike. Full digest on understanding microcomputers. Data and diagrams on all the popular chips. Glossary.

Only \$2.95 No. 70



Learn Micro-Computers

A new multi-media information package for the beginner. You get Understanding Microcomputers book plus high-quality cassette. Great for self-study.

Just \$14.95 No. 40



Calculating with BASIC

$$A^x = 1 + \sum_{q=1}^{INF} \frac{(X \cdot LOG A)^q}{q!}$$

3200 Q=2
3250 AX=AX*((X*LN)/Q)
3300 Q=Q+1

$$A^2 + B^2 = 2AB \cos(AH)$$

10 PRINT "ENTER MAGNITUDES OF FORCES A AND B"
20 INPUT A,B
30 A=ABS(A)
40 B=ABS(B)

For mathematics, finance and statistics, mechanical engineering and electronics

SCELB Publications

6502 SOFTWARE Gourmet Guide & COOKBOOK



Put Together Your Own 6502 Programs Using These Time-Tested Recipes

- General Purpose Routines -
- Conversion Routines -
- Search and Sort Routines -
- Floating Point Routines -
- 6502 Instruction Set -
- And More

SCELB Publications

Calculating with BASIC

Use your computer to calculate home mortgage payments, interest rates, payback periods and more! Shows how to apply the BASIC language to practical problems and equations. Covers the fields of mathematics, finance and statistics, mechanical engineering and electronics. For fun, the games of Hangman and Space Capture are provided. Written by Raymond Guido. Ideal for the businessman, scientist, engineer or student. Complete routines are worked out and ready for you to use.

Just \$7.95 No. 30

Z80, 8080, 6800 & 6502 Software Cookbooks

There's one for each of these popular microprocessors. With the right SCELB Gourmet Guide and Cookbook, you'll be able to put together programs without having to start from scratch. You'll have the most useful routines at your command - already programmed and ready-to-use. Search and sort routines. Many general purpose utility routines. I/O and interrupt programming. How to control and manipulate stacks. Code and numeric conversion routines. Plus more!

For 6502, No. 99, \$10.95; for 6800, No. 50, \$10.95 for 8080, No. 60, \$10.95; for Z80, No. 75, \$14.95

READING

Z80 Instruction Handbook

Convenient pocket size guide to the powerful Z80 instruction set. Machine codes presented in octal and hex format. Instructions also indexed alphabetically.

Only \$4.95 No. 20



Free catalog

10 pages of books for business or pleasure.

No. AA



See SCELB books at your favorite computer or electronics store, or use coupon for direct mail.



SCELB Publications

20 Hurlbut Street, Elmwood, CT 06110

IMPORTANT ORDERING INFO! Include \$1.00 shipping/handling charges for each item. Prices shown are for North American customers. Master Charge, VISA, Postal and Bank Money Orders preferred. Allow 4 weeks for delivery.

- | | | | |
|---------------------------------|---------------------------------|---------------------------------|---------------------------------|
| <input type="checkbox"/> No. 10 | <input type="checkbox"/> No. 20 | <input type="checkbox"/> No. 30 | <input type="checkbox"/> No. 40 |
| <input type="checkbox"/> No. 50 | <input type="checkbox"/> No. 60 | <input type="checkbox"/> No. 65 | <input type="checkbox"/> No. 70 |
| <input type="checkbox"/> No. 75 | <input type="checkbox"/> No. 90 | <input type="checkbox"/> No. 99 | <input type="checkbox"/> No. AA |

Name (please print) _____

Card No. _____

Bank No. _____ Exp. Date _____

Address _____

City/State _____ Zip _____

Signature _____ Date _____

Hydrocarbon Molecule Constructor

Randall S Matthews
The Proctor and Gamble Co
Miami Valley Laboratory
POB 39175
Cincinnati OH 45247

To an organic chemist learning to program a newly acquired microcomputer (in my case, the 16 K byte Apple II), the challenge of "teaching" chemical principles to the computer naturally arises. For example: can the Apple II learn the rudiments of structural organic chemistry, and use that knowledge to assemble and draw simple molecules? This subject is usually covered early in the first semester of sophomore organic chemistry. I decided to write a BASIC program that would accept a hydrocarbon molecular formula as input, and then randomly construct a molecule fitting that formula and draw its structure using high-resolution graphics as output.

Initialization

First, the program must be initialized and the input accepted and analyzed. The user will enter a molecular formula in the form C_nH_m (where C is the number of carbon atoms and H is the number of hydrogen atoms in the molecule).

Clearly, the program must accept only values of C and H that are positive, and less than the maximum numbers allowed by the dimension statement (line 100). However, the dictates of organic chemistry force further restrictions.

In a neutral, ground-state, hydrocarbon molecule, every carbon atom must have exactly four bonds (ie: connections to other atoms), and every hydrogen atom must

have exactly one bond. In 3-methyl-1-butene, as shown in figure 1, notice that each carbon has four connections.

Carbon atom number 2 (C-2) has one bond to C-3, one bond to a hydrogen (H), and two bonds to C-1. Similarly, each H has only one bond. This *valence* restriction means that, for a given number of carbons C, the maximum number of hydrogens is $2 \times C + 2$. A little thought will verify that conclusion.

Consider the propane structure, as shown in figure 2, with a formula C₃H₈ ($8 = 2 \times 3 + 2$). No more hydrogens can be added, since each carbon already has its maximum number of connected atoms. Note that if we make a double bond (C-1 to C-2) to form 1-propene, two hydrogens must be removed. This observation leads to a second restriction: the total number of hydrogens in a hydrocarbon must always be even. A good exercise is to try to draw a counter-example, remembering the valence restrictions.

Connection Table

Having accepted and screened the input, our program must now put together carbon and hydrogen atoms to form a molecular structure that fits the formula input. This process involves the construction of a *connection table*. To illustrate this concept, consider again the molecule in figure 1. How can the information in that structure be numerically represented? One convenient

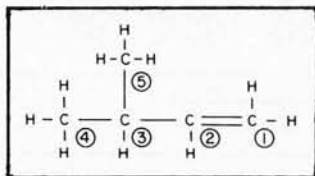

Figure 1: In the hydrocarbon 3-methyl-1-butene, each carbon atom has four connections. This is true of any hydrocarbon molecule.

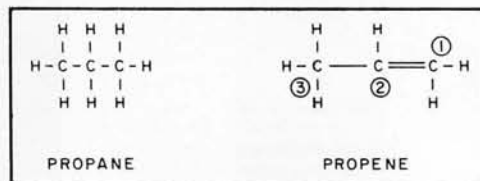

Figure 2: Examples of propane and propene. For any given hydrocarbon with C carbon atoms, the maximum number of possible hydrogen atoms, H, is $2 \times C + 2$.

the electric pencil II™

©1980 Michael Shrayner

is now available
for the TRS-80 Model II* Computer

Standard Printer Version \$275

SERIAL DIABLO, QUME and NEC Printer versions \$300

Features

- CP/M compatible
- Supports four disk drives
- Dynamic print formatting
- DIABLO and NEC printer packages
- Multi-column formatting in one pass
- Print value chaining
- Page-at-a-time scrolling
- Bidirectional multispeed scrolling controls
- Subsystem with print value scoreboard
- Automatic word and record number tally
- Full margin control
- End-of-page control
- Non-printing text commenting
- Line and paragraph indentation
- Centering
- Underlining
- Bold face

The Electric Pencil II is a *Character Oriented Word Processing System*. This means that text is entered as a string of continuous characters and is manipulated as such. This allows the user enormous freedom and ease in the movement and handling of text. Since line endings are never delineated, any number of characters, words, lines or paragraph may be inserted or deleted anywhere in the text. The entirety of the text shifts and opens up or closes as needed in full view of the user. The typing of carriage returns or word hyphenations is not required since lines of text are formatted automatically.

As text is typed and the end of the line is reached, a partially completed word is shifted to the beginning of the following line. Whenever text is inserted or deleted, existing text is pushed down or pulled up in a wrap around fashion. Everything appears on the video display as it occurs, which eliminates guesswork. Text may be reviewed at will by variable speed scrolling both in the forward and reverse direction. By using the search or search and replace functions, any string of characters may be located and/or replaced with any other string of characters as desired.

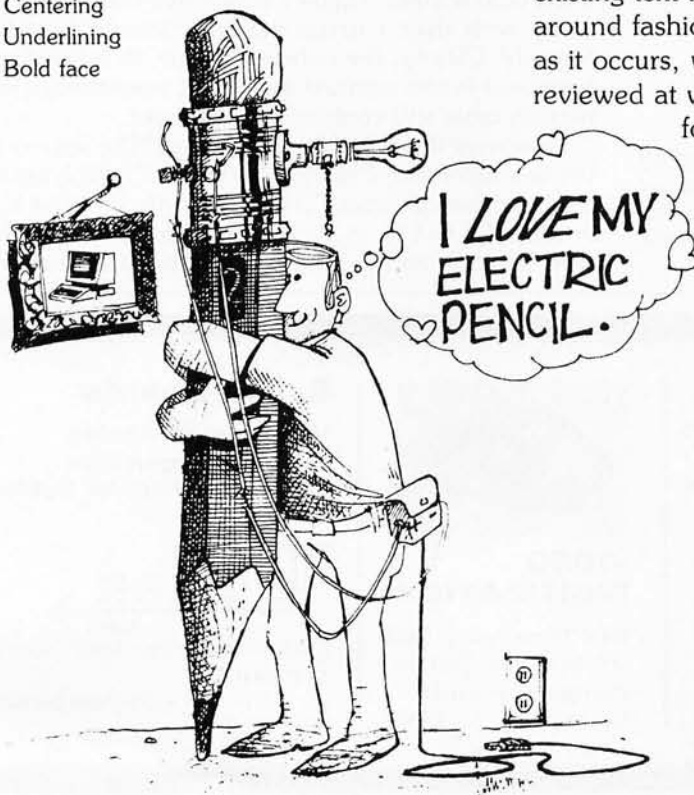

Demand a demo from your dealer!

**m
ss**

MICHAEL SHRAYER SOFTWARE, INC.
1198 Los Robles Dr.
Palm Springs, CA. 92262
(714) 323-1400

	BOND NUMBER			
	1	2	3	4
C1	2	2	0	0
C2	1	1	0	3
C3	4	5	2	0
C4	3	0	0	0
C5	3	0	0	0

Figure 3: A possible method of representing a connection table. This connection table represents every bond for every carbon atom. The information is stored by the computer in the form shown in figure 4.

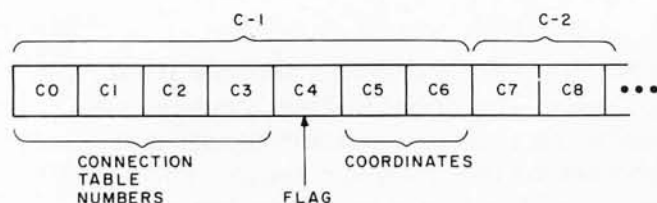

Figure 4: The connection table is stored in array C.

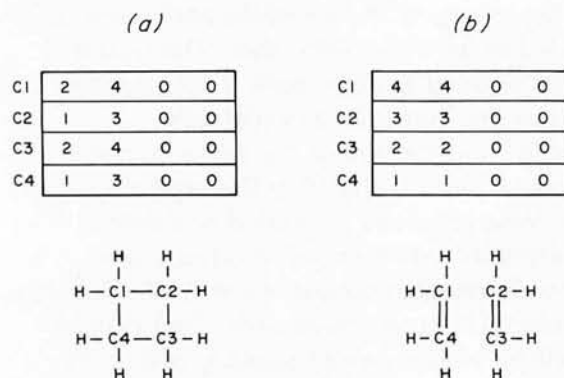

Figure 5: Using the random method of generating connection tables may result in some difficulties. Two connection tables for C_4H_8 are shown. One possible and acceptable connection table is figure 5a. Figure 5b is an unacceptable connection table since it results in two separate molecules.

method is shown in figure 3.

This connection table indicates every bond for every carbon atom. For example, in column 2 of row C3 is a 5, indicating that the second bond of C-3 connects to carbon atom number 5 (C-5). An entry of 0 in the table means connection to a hydrogen. Thus, the number of 0s in the table necessarily equals the number of hydrogens in the molecule. Reading across row C2, we find that carbon C-2 is connected twice to C-1, constituting a *double bond*, once to C-3, and once to a hydrogen.

In the computer, the information contained in the connection table is stored in array C, as indicated in figure 4. The information for C-1 is stored in array elements C(0) thru C(6); the information for C-2 is stored in elements C(7) thru C(13); etc. In every such block of seven elements, the first four elements contain the four numbers from the connection table for that carbon atom. Thus, using the connection table in figure 3 as an example, we have: C(0)=2, C(1)=2, C(2)=0, C(3)=0, C(7)=1, C(8)=1, C(9)=0, C(10)=3, etc. The use of the other elements in the array is explained later.

My first programming impulse was to construct the connection table entirely at random. Unfortunately, this method proved inadequate for several reasons. First, it was very slow. After each attempt at constructing the table, the program would check if the generated numbers were consistent with the input molecular formula. If they were not, as was often the case, the program recycled to try again. This process was very inefficient.

The second problem was that the connection tables generated often *did* satisfy the formula, but led to disconnected structures. For example, suppose the formula C_4H_8 (4,8) is input. Figure 5 shows two connection tables, along with their corresponding structures, that fit this formula. Clearly, the output in figure 5b is unacceptable because it is two separate structures, even though its connection table still conforms to the input.

How may these problems be solved? The answer lies in the new algorithm illustrated in figure 6, which again uses the hypothetical input C_4H_8 . This method begins by connecting C-1 to C-2. A random integer between 0 and 3 is then selected, and C-3 is bound to the carbon atom with

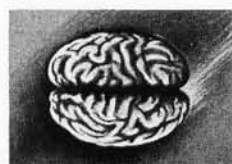

8086 Boards

CPU with \$650.
Vectored Interrupts
PROM-I/O \$495.
RAM \$395.
8K x 16/16K x 8

ANALOG Boards

A/D 16 Channel, \$495.
12 Bit, High Speed
D/A 4 Channel, \$395.
12 Bit, High Speed



VIDEO DIGITIZATION

Real Time Video \$850.
Digitizer and Display
Computer Portrait
System \$4950.

S-100 Boards

Video and/or Analog
Data Acquisition
Microcomputer Systems



The High Performance S-100 People
TECMAR, INC.
23414 Greenlawn • Cleveland, OH 44122
(216) 382-7599

For the Best and Latest in Computer Technology...

Look to Howard W. Sams & Co., Inc.

There's something for everyone—from those who want to discover what computers are all about to those who are already utilizing computers and programming. The fundamentals . . . programming . . . interfacing . . . logic—we are the complete knowledge source for home, business, educational and professional users.

The "Starters"

new



- The Howard W. Sams Crash Course in Microcomputers**
by Frenzel.

Introducing . . . the fastest and most effective way for everyone from the average consumer to the doctor of science to learn about today's microcomputers. Focuses on all aspects of microcomputers from fundamentals and operating systems to programming and modern peripheral equipment such as floppy disks. 264 pages, No. 21634, \$17.50

- How To Buy & Use Minicomputers and Microcomputers**
by Barden.

A single source to buying and using a computer in your home or business to handle recreational or practical tasks from playing games to setting up a burglar alarm. 240 pages, No. 21351, \$9.95

- Getting Acquainted With Microcomputers**
by Frenzel.

Gives you a complete working knowledge of the microcomputer—organization, operation, and programming. 288 pages, No. 21486, \$8.95

- Fundamentals of Digital Computers (2nd Ed.)**
by Spencer.

Unravels the mysteries of computers and programming. 320 pages, No. 21534, \$9.95

- Introduction to Microcomputers for the Ham Shack**
by Helms.

new

Gives the radio amateur an opportunity to be in the forefront of utilizing and developing techniques in "computerations." 96 pages, No. 21681, \$4.95

Prepub Offer—Save 10% (expires 4/30/80)

- Microcomputer Primer, (2nd Ed.)**

new

by Waite and Pardee.
Completely revised and broadened to reflect the latest advances in microprocessor technology from the new 8-bit microprocessors to solderless breadboards. An excellent starting point for all those interested in computers. Approximately 368 pages, No. 21653, Prepub price—\$10.76. Regular Price—\$11.95

The "Programmers"

- How to Program Microcomputers**
by Barden.



A popular, complete guide to assembly language programming of the Intel 8080, Motorola MC6800, and MOS Technology MCS 6502 Microprocessors. 256 pages, No. 21459, \$8.95

- BASIC Programming Primer**
by Waite and Pardee.

Covers everything from getting organized to writing a game program. 240 pages, No. 21586, \$8.95

- DEBUG: An 8080 Interpretive Debugger**
by Titus and Titus.

new

Covers program operation and how it's applied to program development and testing. 112 pages, No. 21536, \$4.95

- 6502 Software Design**
by Scanlon.

new

Tells how to program for the 6502 assembly language. Approximately 288 pages, No. 21656, \$9.95*

- 8080/8085 Software Design, 2 volumes**

by Titus, Larsen, & Titus

new

Volume 1 gives you an introduction to assembly language programming. 336 pages, No. 21541, \$9.50—Volume 2 is a unique, one-of-a-kind, computer science book for the design engineer. Written in Intel machine code. 352 pages, No. 21615, \$9.95

Two-volume set No. 21659, \$17.50

- TEA: An 8080/8085 Co-Resident Editor-Assembler**
by Titus.

new

256 pages, No. 21628, \$8.95

The "Computer Technology" Leaders



- The Z-80 Microcomputer Handbook**
by Barden.

Gives current and prospective users a one-stop source to Z-80 technology—hardware and software aspects and instrumentation problems. 304 pages, No. 21500, \$8.95

- Using the 6800 Microprocessor**
by Poe.

Acquaints you with the hardware and software of the "6800" fun machine. 176 pages; No. 21512, \$6.95

- Computer Graphics Primer**
by Waite.

new

Shows how to create your own graphic affects—from detailed drawings to moving figure animation. 184 pages, No. 21650, \$12.95

- Microcomputers for Business Applications**
by Barden.

Explains the various types of microcomputers available, points out pitfalls to avoid, and defines computer-related terms, or "buzzwords" in easy-to-understand language. 256 pages, No. 21583, \$8.95.

"Interfacing" Bookshelf



- Microcomputer-Analog Converter Software & Hardware Interfacing**

by Titus, Titus, Rony, and Larsen.
Concepts and techniques of interfacing digital computers to analog devices. 288 pages, No. 21540; \$9.50

- TRS-80 Interfacing**
by Titus.

192 pages, No. 21633; \$8.95

- Interfacing & Scientific Data Communications Experiments**
by Rony, Larsen, Titus, & Titus.

160 pages, No. 21546, \$5.95

- Microcomputer Interfacing With the 8255 PPI Chip**
by Goldsbrough.

224 pages, No. 21614, \$8.95

- Z-80 Microprocessor Programming & Interfacing, 2 Volumes**
by Nichols, Nichols, & Rony.

800 pages, No. 21611, \$21.95.

- Introductory Experiments in Digital Electronics and 8080A Microcomputer Programming and Interfacing, 2 Volumes**
by Rony, Larsen, and Titus.

912 pages; No. 21552; \$20.95



"Reference" Library

- Computer Dictionary & Handbook (3rd Ed.)**
by Sippl and Sippl.

new

The best and latest resource for anyone involved in computers or computer applications. over 900 pages; No. 21632 \$25.95

- Computer Dictionary (3rd Edition)**
by Sippl and Sippl.

Over 12,000 entries, 640 pages, No. 21652, \$11.95*

"Logic" Cookbooks

- Lancaster's Cookbook Library**

A famous resource for all electronic buffs who want to know what makes TTLs, CMOS, and active filters cook—what they are, how they work, and how to use them.

by Don Lancaster, one of the most popular authors in the electronics industry.

TTL Cookbook 21035	\$ 9.50
CMOS Cookbook 21398	10.50
Active-Filter Cookbook 21168	14.95
TOTAL LIST PRICE	\$34.95
Less 15% Discount	5.24
You Pay Only	\$29.71

Order Special Library Package No. 21707 and SAVE!

- The Cheap Video Cookbook**
by Lancaster.

256 pages, No. 21524, \$5.95

- IC Op-Amp Cookbook**
by Jung.

592 pages, No. 20969, \$12.95

- IC Converter Cookbook**
by Jung.

576 pages, No. 21527, \$13.95

*Tentative price

Look to Sams . . . In the world of computers

ORDER FORM

HOWARD W. SAMs & CO., INC.
4300 WEST 62ND STREET, P.O. BOX 7092
INDIANAPOLIS, INDIANA 46206
(317) 298-5400

Indicate quantity in boxes above and complete ordering information below:

Sub Total _____

Add local sales tax where applicable _____

GRAND TOTAL _____

Bill Me (Shipping and Handling Charge will be added)

Payment Enclosed (No Shipping Handling Charge)

Check Money Order

Master Charge

Bank Americard/Visa

Exp. Date _____

Account No. _____

Interbank No. _____ (Master Charge Only)

Minimum Credit Card Purchase \$10.00

Please send free 1980 Computer Book Catalog, No. 21719

AD001

Signature _____

Name _____ Last Middle First

Address _____

City _____ State _____ Zip _____

Prices subject to change without notice. All books available from Sams Distributors, Bookstores, and Computer Stores. Offer good in U.S. only.

Note: Distributor, computer store and dealer inquiries are welcome.

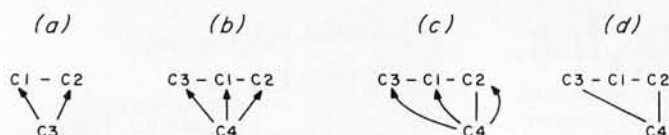

Figure 6: A more efficient method for connecting the carbon atoms is to first connect C-1 to C-2. A random number between 0 and 3 is then selected and C-3 is bound to that carbon atom (6a,6b). C-4 is then randomly connected to one carbon atom in the range C-1 thru C-3. After all carbon atoms have been connected thus, the table is cleaned up by another routine. Two different carbon atoms are chosen randomly and a bond is formed between them if their valence restrictions allow. (Remember there may be only four bonds to a carbon atom.) In the example the final connection is between C-4 and C-3. All of the available bonds will be filled with hydrogen atoms in the final molecule.

that number as shown in figures 6a and 6b. An integer between 0 and 4 is randomly chosen, and C-4 is connected to that atom as shown in figures 6b and 6c.

After all of the carbons have been thusly connected, another routine is used to finish the table, wherein more connections are randomly made as follows. Two different carbons in the existing structure are randomly chosen, and, if the valence restriction allows, a bond is made between them.

In our example, the final connection is made between C-4 and C-3. (See figures 6c and 6d.) After connecting all the carbons, the number of such additional bonds that must be made can be calculated beforehand from the molecular formula according to the equation:

$$EU = ((2 \times C + 2) - H) / 2$$

where EU represents the number of additional bonds to be formed, and C and H are the formula input numbers. The origin of this equation is not within the scope of this article, but the enterprising reader might be able to derive it. EU stands for *elements of unsaturation*. In the example above, $EU = 1$ (for C_4H_8), so only one additional bond

had to be made to complete the connection table. (See figures 6c and 6d.)

Assigning Coordinates

Having assembled the molecule, coordinates for each carbon must now be assigned before drawing the structure. For the final drawing to be as clear as possible, the assignments need to satisfy at least two requirements. First, no two carbons should have the same coordinates; and second, carbons that are bound to each other should be plotted next to each other whenever possible.

The following algorithm was devised to assign coordinates according to the two criteria. Carbon C-1 is given the coordinates 120,75 in the Apple's 270 by 160 high-resolution graphics display. Next, all of the carbons connected to C-1 that do not already have coordinates are assigned coordinates next to C-1. These coordinates are stored in the sixth and seventh elements of the requisite block in array C as shown in figure 4. After its neighbors have been given coordinates, the flag element in C-1's block of array C is set to 1. (Again, see figure 4.) If it has already received its coordinates, the same procedure is then followed for C-2 and continued until all of the carbons have been used. This method does not always give the best or even an adequate representation, but it does offer the advantages of simplicity and speed. Also, the confusing drawings that sometimes result are in most cases easily improved.

Drawing the Structure

With all the necessary information now contained in array C, the final structure may be drawn. This straightforward process uses Apple's machine-language, high-resolution graphics subroutines (stored in hexadecimal locations C00 thru FFF prior to running the program), as well as the several vector tables given in the text box, allowing the atomic symbols to be easily drawn by the shape subroutine. These vector tables must be stored in hexadecimal locations 1000 thru 1129, and are protected by a LOMEM setting that is automatically performed by the BASIC program (line 5).

Text continued on page 166

DO YOU SEE EYE TO EYE WITH YOUR APPLE?

The DS-65 Digisector® opens up a whole new world for your Apple II. Your computer can now be a part of the action, taking pictures to amuse your friends, watching your house while you're away, taking computer portraits... the applications abound! The DS-65 is a random access video digitizer. It converts a TV camera's output into digital information that your computer can process. The DS-65 features:

- **High resolution:** 256 X 256 picture element scan
- **Precision:** 64 levels of grey scale
- **Versatility:** Accepts either interlaced (NTSC) or industrial video input
- **Economy:** A professional tool priced for the hobbyist

The DS-65 is an intelligent peripheral card with on-board software in 2708 EPROM. Check these software features:

- Full screen scans directly to Apple Hi-Res screen
- Easy random access digitizing by Basic programs
- Line-scan digitizing for reading charts or tracking objects
- Utility functions for clearing and copying the Hi-Res screen

Let your Apple see the world!

DS-65 Price: \$349.95
Advanced Video FSII Camera Price \$299.00
SPECIAL COMBINATION PRICE: \$599.00

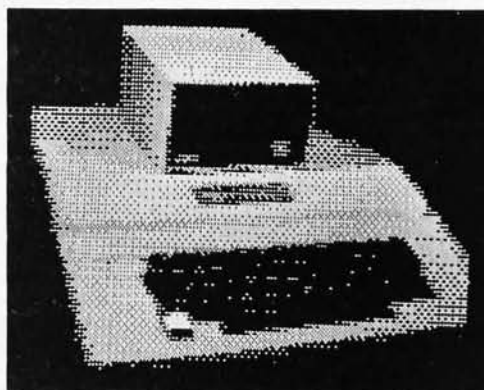

APPLE SELF-PORTRAIT

THE **MICRO
WORKS**

P.O. BOX 1110 DEL MAR, CA 92014 714-942-2400

Everybody's making money selling microcomputers. Somebody's going to make money servicing them.

**New NRI Home Study Course Shows You How to Make Money Servicing, Repairing,
and Programming Personal and Small Business Computers**

Seems like every time you turn around, somebody comes along with a new computer for home or business use. And they're being gobbled up to handle things like payrolls, billing, inventory, and other jobs for businesses of every size...to perform household functions like budgeting, environmental systems control, indexing recipes, and more.

Growing Demand for Computer Technicians... Learn in Your Spare Time

Even before the microprocessor burst upon the scene, the U.S. Department of Labor forecast over a 100% increase in job openings for the decade through 1985. Most of them *new* jobs created by the expanding world of the computer. NRI can train you at home to service both microcomputers and their big brothers. Train you at your convenience, with clearly written "bite-size" lessons that you do evenings or weekends without quitting your present job.

Assemble Your Own Microcomputer

NRI training includes practical experience. You start with meaningful experiments building and studying circuits on the NRI Discovery Lab[®]. Then you build your own test instruments like a transistorized volt-ohm meter, CMOS digital frequency counter...equipment you learn on, use later in your work.

And you build your own microcomputer, the only one designed for learning. It looks and operates like the finest of its kind, actually does more than many commercial units. But NRI engineers have designed components and planned assembly so it demonstrates important principles, gives you working experience in detecting and correcting problems. It's the



kind of "hands-on" training you need to repair and service units now on the market.

Mail Coupon for Free Catalog No Salesman Will Call

Send today for our 100-page, full-color catalog. It describes NRI's new Microcomputer Technology course in detail, shows all equipment, kits, and lesson plans. And it also tells about other NRI courses... Complete Communications with 2-meter

transceiver...TV/Audio/Video Systems Servicing with training on the only designed-for-learning 25" diagonal color TV with state-of-the-art computer programming. With more than a million students since 1914, NRI knows how to give you the most in home training for new opportunity. If coupon has been removed, write to NRI Schools, 3939 Wisconsin Ave., Washington, D.C. 20016.

RUSH FOR FREE CATALOG



NRI Schools
McGraw-Hill Continuing
Education Center
3939 Wisconsin Avenue
Washington, D.C. 20016

Please check for one free catalog only.
NO SALESMAN WILL CALL



All career courses
approved under GI Bill.
 Check for details.

- Computer Electronics Including Microcomputers
- TV/Audio/Video Systems Servicing
- Complete Communications Electronics with CB • FCC Licenses • Aircraft, Mobile, Marine Electronics
- CB Specialists Course
- Amateur Radio • Basic and Advanced

- Digital Electronics • Electronic Technology • Basic Electronics
- Small Engine Repair
- Electrical Appliance Servicing
- Automotive Mechanics
- Auto Air Conditioning
- Air Conditioning, Refrigeration, & Heating Including Solar Technology

Name _____ (Please Print) Age _____

Street _____

City/State/Zip _____

Accredited by the Accrediting Commission of the National Home Study Council

170-030



Circle 103 on inquiry card.

Listing 1: An Apple II integer-BASIC program for generating hydrocarbon representations using the available high-resolution graphic routines. The high-resolution routines use the graphics tables in listing 2.

```

5 POKE 284, 4400 MOD 256: POKE 285, 4400/256: POKE 74, 4400 MOD 256: POKE
  75, 4400/256
10 GOTO 180
30 POKE 802, Y: POKE 800, X MOD 256
35 POKE 801, X/256: RETURN
40 POKE 804, X MOD 256: POKE 805, X/256: RETURN
100 DIM C(110)
110 TEXT : CALL -936: VTAB 5: TAB 8: PRINT "APPLE-CHEM II"
120 VTAB 10: PRINT "THIS PROGRAM WILL DRAW A MOLECULE": PRINT "FOR A GIVEN M
  OLECULAR FORMULA. "
130 VTAB 15: PRINT "ENTER A MOLECULAR FORMULA": PRINT "IN THE FORM 'ChHw' W
  HERE"
140 PRINT "'C' = THE NUMBER OF CARBON ATOMS": PRINT "IN THE MOLECULE, ETC. "

150 INPUT NC, NH
152 NF=0
155 IF NC#-100 THEN 160: NC= RND (7)+2: NH=((2*NC)/2)*2
157 NF=1: CALL -936: VTAB 22: PRINT "C-"; NC; ", H-"; NH: GOTO 180
160 IF NC>1 AND NC<16 AND NH>-1 AND NH<=2*NC+2 AND (NH/2=NH-NH/2) THEN
  180
170 PRINT : PRINT "IMPROPER DATA!": PRINT "C MUST BE >= 2 AND < 16": PRINT
  "H MUST BE EVEN, >= 0 AND <= 2*C+2": GOTO 150
180 EU=((2*NC+2)-NH)/2
190 FOR I=0 TO NC*7:C(I)=0: NEXT I
200 C(0)=2:C(7)=1: IF NC=2 THEN 300
210 FOR I=3 TO NC
220 X= RND (I-1)+1
230 IF C((X-1)*7+1)#0 THEN 250
240 C((I-1)*7)=X:C((X-1)*7+1)=I: GOTO 290
250 IF C((X-1)*7+2)#0 THEN 270
260 C((I-1)*7)=X:C((X-1)*7+2)=I: GOTO 290
270 IF C((X-1)*7+3)#0 THEN 290
280 C((I-1)*7)=X:C((X-1)*7+3)=I
290 NEXT I
300 IF EU=0 THEN 410
310 FOR K=1 TO EU
320 X= RND (NC)+1: Y= RND (NC)+1: IF X=Y THEN 320
330 FOR I=1 TO 3: IF C((X-1)*7+I)#0 THEN 350
340 X1=I: GOTO 360
350 NEXT I: GOTO 320
360 FOR I=1 TO 3: IF C((Y-1)*7+I)#0 THEN 380
370 Y1=I: GOTO 390
380 NEXT I: GOTO 320
390 C((X-1)*7+X1)=Y:C((Y-1)*7+Y1)=X
400 NEXT K
410 FOR I=4 TO (NC-1)*7+4 STEP 7: FOR J=0 TO 2
420 C(I+J)=0: NEXT J: NEXT I
430 GOSUB 1000: GOSUB 2000
435 CALL -936: VTAB 22
437 IF NF#1 THEN 440: NC=-100: GOTO 155
440 PRINT "HIT 'D' TO DRAW THIS DIFFERENTLY"
450 PRINT "HIT 'I' FOR A NEW ISOMER (SAME FORMULA)"
460 PRINT "HIT 'F' FOR A NEW MOLECULAR FORMULA"
470 KEY= PEEK (-16384): IF KEY<128 THEN 470
480 POKE -16368, 0
490 IF KEY=196 THEN 410: IF KEY=201 THEN 190: IF KEY=198 THEN 110
500 END

```



```

1000 C(5)=120:C(6)=75
1010 FOR K=1 TO NC: IF C((K-1)*7+4)=0 AND C((K-1)*7+5)#0 THEN 1030
1020 NEXT K: GOTO 1090
1030 FOR I=0 TO 3:J=(K-1)*7+I: IF C(J)=0 THEN 1080
1040 IF C((C(J)-1)*7+5)#0 THEN 1080
1050 GOSUB 1500
1060 FLAG=0: GOSUB 1600: IF FLAG=1 THEN 1050
1070 C((C(J)-1)*7+5)=TX:C((C(J)-1)*7+6)=TY
1080 NEXT I:C((K-1)*7+4)=1: GOTO 1010
1090 RETURN
1500 TX=C((K-1)*7+5):TY=C((K-1)*7+6)
1510 A1=(RND(3)*30)-30:A2=(RND(3)*30)-30
1520 TX=TX+A1:TY=TY+A2
1530 IF TX<4 OR TX>264 OR TY<4 OR TY>152 THEN 1500
1540 RETURN
1600 FOR II=1 TO NC
1610 IF C((II-1)*7+5)=TX AND C((II-1)*7+6)=TY THEN 1630
1620 NEXT II: GOTO 1640
1630 FLAG=1
1640 RETURN
2000 CALL 3072: POKE 812,255: POKE 806,1: POKE 807,0
2010 S=3805:L=3786:P=3780: POKE 28,255
2020 FOR I=1 TO NC: FOR J=0 TO 3: IF C((I-1)*7+J)=0 THEN 2160
2030 FLAG=0: IF C((I-1)*7+J)<I THEN 2160
2040 FOR K=0 TO 3: IF K=J THEN 2060
2050 IF C((I-1)*7+K)=C((I-1)*7+J) THEN FLAG=FLAG+1
2060 NEXT K:T=C((I-1)*7+J)
2070 X1=C((I-1)*7+5):Y1=C((I-1)*7+6):X=X1:Y=Y1
2080 GOSUB 30: CALL P
2090 X2=C((T-1)*7+5):Y2=C((T-1)*7+6):X=X2:Y=Y2
2100 GOSUB 30: CALL L: IF FLAG<1 THEN 2160
2110 X=X1+6:Y=Y1+3: GOSUB 30: CALL P
2120 X=X2+6:Y=Y2+3: GOSUB 30: CALL L
2130 IF FLAG#2 THEN 2160
2140 X=X1-3:Y=Y1-6: GOSUB 30: CALL P
2150 X=X2-3:Y=Y2-6: GOSUB 30: CALL L
2160 NEXT J: NEXT I
2170 FOR I=1 TO NC:X1=C((I-1)*7+5):Y1=C((I-1)*7+6)
2180 POKE 812,0:X=X1:Y=Y1+2: GOSUB 30: CALL P
2190 POKE 804,4199 MOD 256: POKE 805,4199/256: CALL S: POKE 812,255
2220 X=X1:Y=Y1: GOSUB 30: CALL P:FLAG=0
2230 FOR J=0 TO 3
2240 IF C((I-1)*7+J)=0 THEN FLAG=FLAG+1
2250 NEXT J
2260 IF FLAG#0 THEN 2280
2270 X=4096: GOSUB 40: GOTO 2330
2280 IF FLAG#1 THEN 2300
2290 X=4107: GOSUB 40: GOTO 2330
2300 IF FLAG#2 THEN 2320
2310 X=4130: GOSUB 40: GOTO 2330
2320 X=4166: GOSUB 40
2330 CALL S: NEXT I: RETURN

```

Listing 2: The program in listing 1 uses a high-resolution shape (or vector) table which is shown here. It stores shapes for the chemical symbols. The operation of the shape table is defined in the Apple II Programmer's Manual and in the documentation for the high-resolution routines. These vector tables are used to draw the different parts of molecules on the video screen.

1000-	22	64	2D	15	96	F2	3F	07	1028-	17	17	36	28	2D	D5	DB	C3
1008-	20	04	00	24	2D	2D	24	34	1030-	18	08	18	24	24	24	DF	33
1010-	36	36	FE	1B	24	24	24	D7	1038-	36	36	3E	D8	1E	3F	07	20
1018-	E3	3F	17	36	36	0E	2D	05	1040-	24	64	2D	15	06	00	2E	2D
1020-	20	00	2D	2D	4D	62	AD	F6	1048-	AD	09	0C	AD	36	3F	2D	36

Listing 2 continued on page 164

Listing 2 continued:

```

1050- 1E 3F E0 D8 24 24 24 DF
1058- 33 36 36 3E D8 1E 3F 07
1060- 20 24 64 2D 15 06 00 24
1068- 24 24 24 3C 3F 3F 3F 3F
1070- 3F 2D 2D 2D 2D 2D 2D 2D
1078- 2D 2D 2D 2D 3E 3F 3F 3F
1080- 3F 3F 3F 3F 3F 3F 3F 37
1088- 2D 2D 2D 2D 2D 2D 2D 2D
1090- 2D 2D 2D 3E 3F 3F 3F 3F
1098- 3F 3F 3F 3F 3F 3F 37 2D
10A0- 2D 2D 2D 2D 2D 2D 2D 2D
10A8- 2D 2D 3E 3F 3F 3F 3F 3F
10B0- 3F 3F 3F 3F 3F 37 2D 2D
10B8- 2D 2D 2D 2D 2D 2D 2D 2D
    
```

```

10C0- 2D 3E 3F 3F 3F 3F 3F 3F
10C8- 3F 3F 3F 3F 37 2D 2D 2D
10D0- 2D 2D 2D 2D 2D 2D 2D 2D
10D8- 3F 3F 3F 3F 3F 3F 3F 3F
10E0- 3F 3F 3F 37 2D 2D 2D 2D
10E8- 2D 2D 2D 2D 2D 2D 2D 3E
10F0- 3F 3F 3F 3F 3F 3F 3F 3F
10F8- 3F 3F 37 2D 2D 2D 2D 2D
1100- 2D 2D 2D 2D 2D 2D 3E 3F
1108- 3F 3F 3F 3F 3F 3F 3F 3F
1110- 3F 37 2D 2D 2D 2D 2D 2D
1118- 2D 2D 2D 2D 2D 3E 3F 3F
1120- 3F 3F 3F 3F 3F 3F 3F 3F
1128- 07 00
    
```

Table 1.

Program Lines	Function
5	Set LOMEM:4400
30-40	Subroutines used for drawings.
100-170	Accept and analyze input.
180-400	Construct connection table.
435-500	Special features.
1000-1640	Subroutine to assign coordinates.
2000-2330	Subroutines to draw molecule.

Program Notes

Since remark statements were deleted from the final program to increase execution speed, the explanations provided in table 1, should prove useful when reading the program. Table 2 provides a list of all machine language accesses in the Apple II used in this program. These explanations should help implement the chemistry program on a different computer.

Table 2.

Command	Occurrence	Effect
POKEs to 204, 205, 74, 75	line 5	Set LOMEM:4400. This protects the vector table in the Apple's memory from being written over.
POKEs to 802, 801, 800	lines 30, 35	These locations hold the coordinates for the next point to be plotted.
POKEs to 804, 805	line 40	These locations hold the address of the part of the vector table containing the shape about to be drawn.
CALL 3072	line 2000	Initializes high-resolution graphics mode.
POKE 812, 255 POKE 806, 1	lines 2000, 2190 line 2000	Set color to white. Set scaling factor to 1. (full size)
POKE 807, 0	line 2000	Set rotation factor to 0. (right side up)
CALL P	lines 2080, 2110, 2140, 2180, 2220	Causes point to be plotted at coordinates set in SUB 30.
CALL L	lines 2100, 2120, 2150	Causes line to be drawn from last point plotted to coordinates set in SUB 30.
POKE 812, 0 CALL S	line 2180 lines 2190, 2330	Set color to black. Cause shape to be drawn starting at last point plotted (line 2180). Shape is determined by which section of vector table is poked into locations 804 and 805 as shown below:
	table location	figure drawn
	4199	blank space
	4096	C
	4107	CH
	4130	CH ₂
	4166	CH ₃

SINK THE BISMARCK WITH YOUR APPLE!

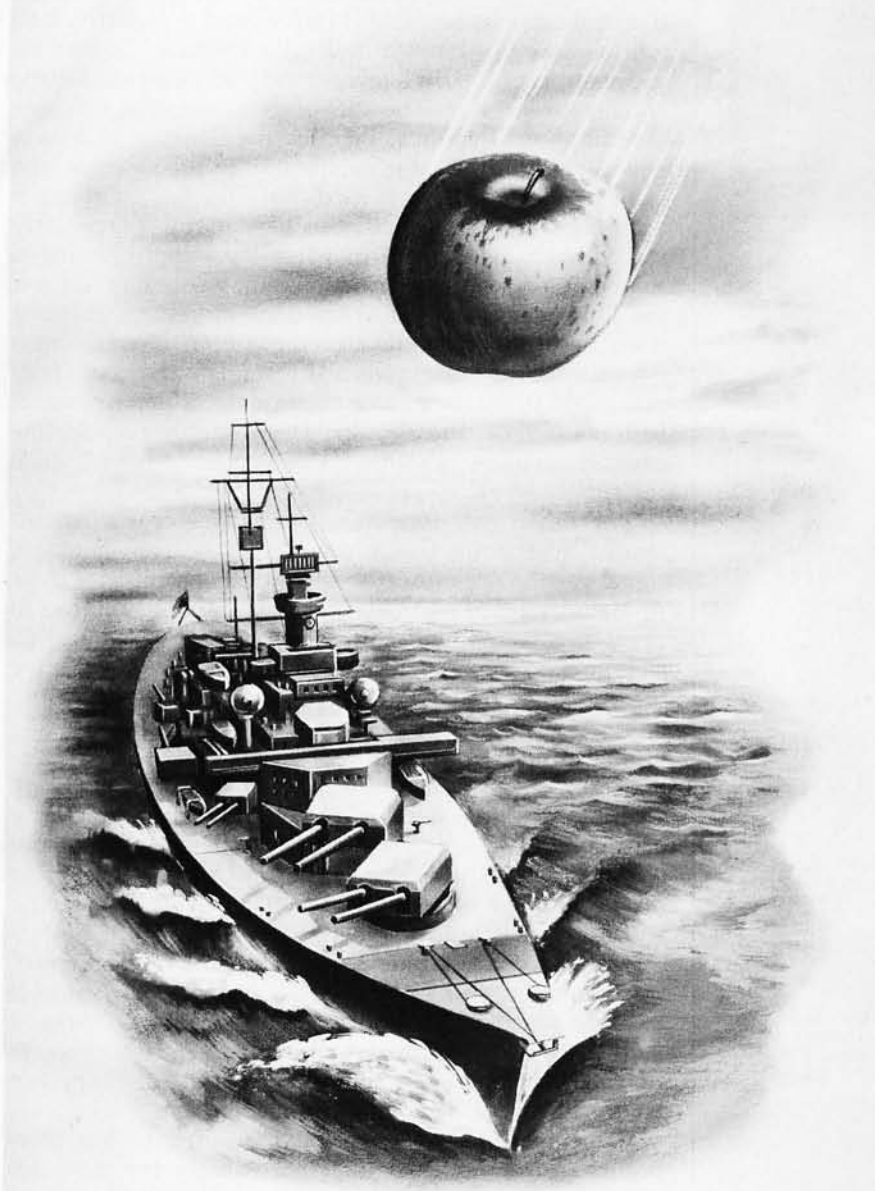

Historical wargaming may be the only intellectual hobby which creates more intensely devoted fanatics than home computing. When two wargamers spend an evening refighting a famous battle, they'll spend several hours happily setting up the gameboard, firepower charts, unit strength tables and so forth... all before the first shot can be fired! There are such paper & pencil simulations of every famous battle from Shiloh to El Alamein. If you've ever tried one, you already know the excitement and challenge of trying to be a better general than Rommel.

Home Computer

Now there's a true historical wargame for your home computer. **Computer Bismarck™** accurately simulates the epic battle between the awesome German battleship and the British Home Fleet. Best of all, the computer program eliminates the drudgery of paper & pencil wargames—remembering all the rules and details while keeping track of the battle on a North Atlantic map on your video display.

Play the Computer

It maneuvers the Bismarck and U-boat wolfpacks so well that you'll have to command the British ships and aircraft brilliantly to avoid losing your merchant convoys (and World War Two along with them).

Play a Human

Just like Staff Officer training at the War College, each of you plots his strategies in grease pencil on an off-screen mapboard while the battle is fought on the video screen (monochrome or multicolor depending on your display capabilities). You deploy battleships, cruisers, carriers, destroyers, submarines, oilers, merchant ships, recon planes, and bombers—each with unique and realistic operating parameters. You must deal with all the variables which challenge an actual battle commander: aircraft endurance; naval fuel, firepower and damage; shadowing and searching ability (better in radar-equipped vessels); and visibility—which depends on weather, which varies with geography and time. If a game is interrupted, the program will save it on a minidisc.

More like Chess than Pong

Computer Bismarck is a test of intellect and courage rather than hand-eye coordination. If you can imagine playing chess with pieces like a knight who must return to the stables periodically for a fresh horse or a queen whose radius of action can be affected by battle damage...all on a 360 square chessboard partially obscured by thunderstorms and fog...that's **Computer Bismarck!**



\$59.95 and an Apple

If you've got an Apple II Plus (or an Apple II with Applesoft Firmware ROM Card) with 48K memory and a 5 1/4" mini floppy disc drive, you can be playing **Computer Bismarck** in a few days. For \$59.95, you get the game program disc, 2 mapboard charts (for plotting secret strategies in grease pencil between moves), 2 ship data charts, 2 system command cards, a loading instruction sheet, and a rulebook.

Credit card holders call **800-648-5600** (toll free) and ask Operator 180 to charge it to your VISA or MASTERCARD (Nevada only call 800-992-5710). Or send a check for \$59.95 to Strategic Simulations, Inc., P.O. Box 5161, Stanford, CA 94305 (California residents add \$3.90 sales tax). **Computer Bismarck** will be available soon for the TRS-80 and other home computers.

COMPUTER BISMARCK™. There's never been anything like it.

Circle 104 on inquiry card.

free freight

We'll pay the surface freight on all pre-paid products featured in this ad to any of 18,000 U.S. tariffed locations. No handling charges, add on costs, insurance fees or credit card fees!



TI 99/4

Built in equation calculator, 13" color monitor, 16-bit C.P.U., TI Basic w/13 digit precision, and more!
CALL US FOR LOW PRICE!



Soroc IQ 120

High quality, professional text-editing terminal. 73-key board, built in 2K RAM.
\$789



Hazeltine 1500

7X10 matrix, baud rates to 19,200; full keyboard with numeric pad, full function CRT at a new low price!
\$950

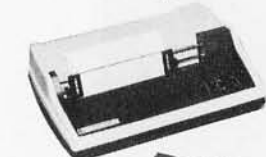

TI 810

Basic 150 cps serial. The industry leader at a new low price! Save over \$300.
\$1589



Centronics 730

100 cps, parallel, 3-way feed, 80-character buffer...the new leader in small printers from Centronics. Save \$100.
\$895



Comprint 912

Low priced electrostatic matrix printer, 225 cps.
Serial **\$535**
Parallel **499**



North Star Horizon

Call us for our low prices on the industry's most popular C.P.U.

Televideo 912 **\$779**
Centronics 704 **\$1685**
Heath WH 14 **\$749**

Over 2000 products from over 100 manufacturers. Prices subject to change without notice, products subject to availability. FOB Tempe, AZ (5% sales tax in Arizona)

Call now
TOLL FREE **1-800-528-1418**

MICROWORLD®

1425 W. 12th Pl. • Tempe, AZ 85281 • (602) 894-1193

Text continued from page 160:

Program Description and Instructions

To run the program, load the high-resolution graphics subroutines, the vector tables, and the BASIC program (remembering to set HIMEM;8192) and type RUN. You will be asked to input a molecular formula. To test the program, type 4,8. In a few seconds, an isomer of butene should appear. At the bottom of the screen, you will note several special features. Pressing the D key will draw a new picture of the same compound; in other words, the same connection table is used, but different coordinates are assigned. This command is very useful, particularly for complicated structures, when the initial drawing is too confusing to understand. You may continue to press the D key until a satisfactory drawing results. Pressing the I key isomerizes the structure (ie: a different compound with the same molecular formula is drawn). Thus, you could investigate some of the many isomers of tetrahydrene (C_4H_4). Pressing the F key simply recycles the program to allow new input. Pressing any other key ends the run.

One other very interesting special feature is demonstrated by entering the "formula" -100,0. This input is a signal for the program to begin drawing structures from randomly chosen molecular formulae. It will continue to draw new compounds until interrupted by control-C. This feature makes a fascinating demonstration display for the Apple II.

Concluding Comments

Finally in possession of a running program, you may well inquire: what good is it? Certainly, for a practicing organic chemist, the program has little practical value. However, by exposing several of my chemist friends to the program, I have found that they do enjoy playing with it, especially the isomerization feature. It is fun!

For those who are interested in practical applications of microcomputing, I stress that this program has valuable use in chemical education. For beginning organic students, it provides an enjoyable introduction to numerous seminal concepts of structural chemistry (eg: to the ideas of structural isomerism and valence requirements). Moreover, it could be used to test comprehension of nomenclature, particularly for more advanced students. For instance, I have enjoyed entering formulae and challenging others to assign International Union of Pure and Applied Chemistry (IUPAC) names to the resulting structures.

In closing, I must point out that the program described here is only a beginning. Several potential improvements immediately spring to mind. One is the possibility of the Apple drawing three-dimensional representations. Also, anyone with much chemical background will quickly realize that many structures generated by the program are rather unlikely, if not practically impossible. For instance, the Apple does not hesitate to draw cyclopropadiene, an impossibly strained ring. It might be possible to teach the Apple such concepts as ring strain and Bredt's rule; however, I am not sure if that would be desirable. Much of the program's charm derives from its naive approach to molecular assemblage, yielding delightfully unexpected structures. And who knows? Recent experience in organic synthesis has demonstrated that improbable structures are not always impossible. ■



Put the BYTE on the IRS with Aardvark™

In an era when computers are an integral part of business and entertainment, and computer software is more and more sophisticated, Aardvark™ is yet another breed in advanced computer software. Aardvark's™ Micro Tax series is a true user-oriented Federal Income Tax package. Specifically developed by qualified tax professionals for use on personal home computers, this low-cost, time-saving Aardvark™ Micro Tax package accurately and efficiently computes your federal income tax liability. Aardvark™ will display and fill in facsimile Form 1040 and related schedules and,

when connected to a printer by means of a standard interface, will print out these facsimile forms automatically. Each program is designed to use the appropriate tax table or rate schedule. The Aardvark™ package includes an indexed instruction manual and input forms for easy input of tax data. To see how Aardvark™ can be tax-deductible, check the instructions in the binder of the manual. You can also use the binder to store pertinent 1979 tax records. Cure your headaches this tax season, order today . . . and put the BYTE on the IRS with Aardvark™!

MICRO TAX I **\$25**
 Form 1040
 Schedule A
 Schedule B
 Schedule TC
 (will not calculate Income Averaging, Max Tax, or Alternative Minimum Tax)

MICRO TAX II **\$35**
 Form 1040
 Schedule A
 Schedule B
 Schedule G (Inc. Avg.)
 Schedule TC
 Form 4625 (Min. Tax)
 Form 4726 (Max. Tax)
 Form 6251 (Alt. Min. Tax)

MICRO TAX III **\$50**
 Micro Tax II plus
 Schedule C
 Schedule D
 Schedule E
 Schedule SE
 Form 2119 - Sale of Personal Residence
Disk Version **\$60**

MICRO TAX IV **\$100**
 Expanded disk version of Micro Tax III
 Printed forms can be filed with the IRS

When Ordering Specify:
 TRS-80 16K Level II Basic
 Apple II 32K with Applesoft Basic
 Apple II 16K Micro with Applesoft ROM Card
 TI 99/4 with drive cassette
 PET 16K

Aardvark Software

MICRO TAX V **\$150**
 Expanded disk version of Micro Tax III plus Form 2210
 Provides for hash totals and batch processing
 Printed forms can be filed with IRS

For more information write:
 P.O. Box 26505
 Milwaukee, WI 53213



24 hrs. Orders only call TOLL FREE 1-800-558-8570. **7 days**

In Wisconsin 1-414-289-9988



©Aardvark Software, Inc. 1979

Book Reviews

What Computers Can't Do

Hubert L Dreyfus
Harper and Row
New York 1972
hardcover, 259 pages
\$10.95

Brain, Mind and Computers

Stanley L Jaki
Gateway Editions
1969
softcover, 267 pages
\$4.95

What Computers Can't Do and *Brain, Mind and Computers* are two widely available critiques of artificial intelligence. Their authors bring somewhat different credentials to the task. Hubert Dreyfus is a philosopher who has worked in artificial intelligence research for well over a decade, and Dr Jaki is a theologian concerned with the philosophy of science.

What Computers Can't Do is a follow-up on a RAND Corporation paper which Dreyfus did in the mid-1960s. The question he raises is why, after the rapid advances in artificial intelligence research during the 1950s, was there such a slowdown in results during the 1960s and early 1970s? Many of the results which were forecast for the period 1969 thru 1979 never occurred (such as general-purpose language translation, innovative work in mathematics by computers, etc). Dreyfus believes that there are a number of mistaken assumptions underlying the hopes in artificial intelligence research; assumptions about how we think and about the nature of the world. His conclusion is that more attention must be paid to the ways in which humans think about things and how these differ from the ways in which computers work. He argues that the result of this is a classification of tasks into different groups, some of which are definitely fair game for machines, some of which pose serious problems, and some of which are not likely to yield human-type performance to computers as they are presently designed.

Overall, this book is very interesting reading, and contains well-thought-out discussions of many of the issues in artificial intelligence research.

Brain, Mind and Computers was originally published ten years ago and has since been reissued. It is ostensibly a discussion of artificial intelligence research; it is in fact a refutation of physicalism, which the author maintains is synonymous with determinism. While discussing artificial intelligence at length, Dr Jaki never defines what he means by it; he seems to mean a machine which will be fully equivalent to the human mind in all respects. Given this implicit definition, the task of arguing against the possibility is simplified.

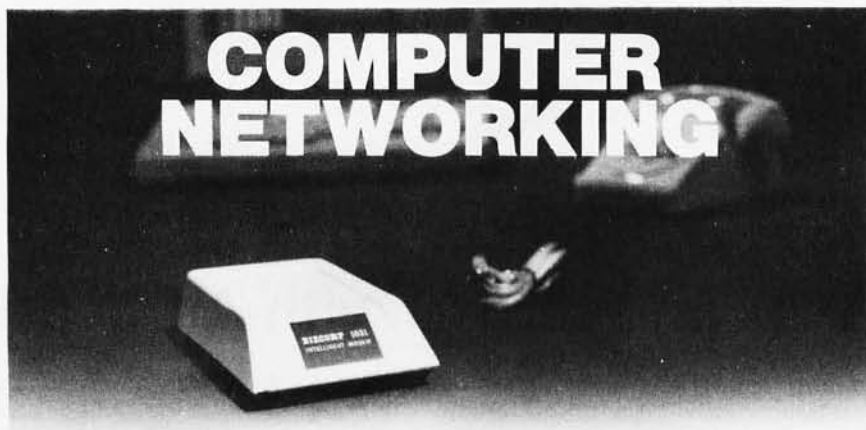

High quality networking demands high quality communications. That's why the best computer companies recommend BIZCOMP Intelligent Modems.™ They choose BIZCOMP for reliability, volume delivery and speedy development of communications software. You'll choose BIZCOMP for features like:

- Automatic Repeat Dialing
- Self Test
- Automatic Answer
- Friendly, Conversational Interface
- Automatic Baud Rate Acquisition
- FCC Registered — Direct Connection
- Bell 103 Series Compatible
- UL/CSA Approved

BIZCOMP's unique Code-Multiplexed Design enables complete control using a simple 3-wire RS-232 interface. With BIZCOMP attached, your "dumb" terminal acquires "intelligent" features with comm rates from 110, 134.5, 150, 200 to 300 baud. See BIZCOMP's Intelligent Modems today at your local dealer, or write to us directly.

BIZCOMP Communications...why not start with the best?

BIZCOMP

P.O. Box 7498
Menlo Park, California 94025
415/854-5434

Suggested prices from \$395.00

Patent Pending

ALMOST PERFECT.

The **MAGIC WAND**TM is the most powerful, most flexible, most reliable, *most usable* word processing software available for a CP/M[®]-based computer.

That's not bragging. That's just telling it like it is.

The MAGIC WAND is the best word processing software ever written for a microcomputer. It can do more work in less time with higher quality than any other product you can buy.

The MAGIC WAND is a rock solid piece of software. The command structure is simple and logical and complete. We have not tossed in features without thought to the overall design of the package. Nor have we included any feature that is not thoroughly implemented. The programs are crash-proof and completely reliable.

And the system is supported by what we are told is the best user's manual ever produced for microcomputer software. It contains a step-by-step instructional program designed for the novice. The trainee uses sample files from the system disk and compares his work to simulated screens and printouts in the manual.

Support doesn't stop when you buy the package. As a registered user, you receive our bi-monthly newsletter which answers questions, reports upgrades and teaches new applications of the MAGIC WAND.

It's through a lot of hard work that we are able to offer you a product that is "almost perfect," but we aren't about to stop working until we can say that the MAGIC WAND is perfect.

Full screen text editing

The MAGIC WAND has probably the most responsive and easy-to-use editor available for either a serial or DMA terminal. It uses only single stroke control keys to give command and takes advantage of the special function keys on your terminal whenever possible. In addition, you can set up library files with coded sections that you can merge by section name.

Full text formatting commands

The MAGIC WAND allows you to set the left, right, top and bottom margins, page length, indentation, paragraph indentation, (including "hanging" paragraphs), text left flush, right flush, justified (two ways), literal or centered, variable line and pitch settings, variable spacing (including half lines), bold face, underlining (solid or broken), conditional hyphenation, sub- and superscripting. You may change any of these commands at run-time *without reformatting the file*.

Merging with external data files

You may access any external data file, with either fixed length or sequential records. The MAGIC WAND converts the record into variables that you define and can use like any other variable. Of course, you may use the data for automatic form letter generation. But you can also use it for report generation.

Variables

You may define up to 128 variables with names of up to seven characters. The current value of a variable may be up to 55 characters, and you may print it at any point in the text without affecting the current format. Although the MAGIC WAND stores the variables as strings, you may also treat them as integer numbers or format them with commas and a decimal point. You may increment or decrement numeric variables or use them in formatting commands.

Conditional commands

You may give any print command based on a run-time test of a pre-defined condition. The conditional test uses a straightforward IF statement, which allows you to test any logical condition of a variable. You may skip over unneeded portions of the file, select specific records to print, store more than one document in a single file, etc.

True proportional printing

The MAGIC WAND supports proportional print elements on NEC, Diablo and Qume printers. Other formatting commands, including justified columns, boldface, underline, etc., are fully functional while using proportional logic.

Available on 8" soft-sectored and 5 1/4" Northstar or Micropolis (hard or soft sectored) diskettes, as well as ONYX hard disk. Terminals supported include—ADDS, Beehive, Cromemco, Dynabyte, Hazeltine, Heath, Imsai, Intertec, Lear Siegler, Microterm Act V, Perkin Elmer, Sol VDM1, Soroc, TEC, TEI, Televideo, TRS80 Mod II, Vector Graphics, plus a variety of video boards.

small business applications, inc.

3220 Louisiana • Suite 205 • Houston, Texas 77006 • 713-528-5158

CP/M is a registered trademark of Digital Research Corp

Brain, Mind and Computers is an excellent guide to the history of physicalism in scientific thought. The computer is taken as a metaphor for "machine," and artificial intelligence is taken in its strongest sense—a sense that is almost unknown in the current artificial intelligence research literature.

John A Lehman
716 Hutchins #2
Ann Arbor MI 48103

Z80 Software Gourmet Guide and Cookbook

Nat Wadsworth
Scelbi Publications, 1979
softcover, 322 pages
\$14.95

The *Z80 Software Gourmet Guide and Cookbook* is one in a series of such books which Scelbi has published; previous "cookbooks" have appeared for the 8080 and the 6800

processors. The primary theme behind these books is to explain how to perform common assembly-language programming tasks for the various microprocessors, and to provide tested routines for these tasks which can be included as part of larger programs.

The Z80 volume covers the Z80 instruction set, utility operations (such as multibyte arithmetic), stack operations, input/output (I/O) processing, character-code conversion, searching

and sorting, decimal arithmetic, and floating point arithmetic. These topics were also covered in the 8080 volume. Additional chapters in the Z80 book include one that presents a simple space-capture game, and one entitled "Creative Programming Concepts," which discusses data structures. Appendices include the Z80 instruction set, character code and number-base tables, and hexadecimal object code dumps for the major programs in the book.

The first question that comes to mind is, "How does this book differ from the 8080 volume?" Obviously, the sections on the instruction set are changed. Besides having many more instructions to explain, the Z80 book uses Zilog mnemonics. Unfortunately, much of the rest of the book contains the old 8080 code with new mnemonics. Even the discussion of interrupts in the I/O section treats only mode 0 (8080-compatible), which is probably the least useful for anyone not trying to write 8080-executable code.

Another example of the lack of changes: absolute-jump instructions are used throughout the book where almost any Z80 programmer would use relative jumps. The major changes in the book then seem to be the discussion of the instruction set, the two new chapters, and the fact that the floating point routines appear to be shorter. If you have the 8080 volume, do not purchase this volume.

If you do not have the 8080 volume, then that is another story. Whether you want to convert American Standard Code for Information Interchange (ASCII) to Baudot code (or Selectric correspondence code), parse an input string, change number representations, fill memory, write timing loops, or whatever, you will probably find just the subroutine you are looking for. I have been taking subroutines out of the 8080 version of this book for two years now, and have yet to

The COMPUTER FACTORY

TO ORDER CALL (212) 687-5000

SUPERBRAIN™

INTERTEC DATA SYSTEMS

32K ONLY \$2995
64K \$3245



More than an intelligent terminal, the SuperBrain outperforms many other systems costing three to five times as much. Endowed with a hefty amount of available software (BASIC, FORTRAN, COBOL), the SuperBrain is ready to take on your toughest assignment. You name it! General Ledger, Accounts Receivable, Payroll, Inventory or Word Processing... the SuperBrain handles all of them with ease.

FEATURES INCLUDE: NOW IN STOCK

- Two dual-density minifloppies with 320K bytes of disk storage
- 32K of RAM to handle even the most sophisticated programs
- A CP/M Disk Operating System with a high-powered text editor, assembler and debugger

AVAILABLE SOFTWARE • Accounts Receivable/Payable \$125.00
• General Ledger \$125 • Payroll with cost accounting \$125
• Wordstar \$500 • Selector III-C2 \$390 • M Basic-80 \$350
• CBASIC-2 \$125 • M Basic Compiler \$460.

Commodore Computer

These low cost Commodore PET Business Computers have virtually unlimited business capabilities. Accounts Receivable, Inventory Records, Payroll, and other accounting functions.

PET 16K & 32K COMPUTERS

- Full size keyboard
- 16 or 32,000 Bytes Memory
- Level III Operating System
- Full Screen Editor
- Upper/lower case & 64 graphic characters



PET DUAL FLOPPY DISK
Stores 300,000 Bytes on-line
• Microprocessor controlled
• Uses single or dual sided floppies

HI-SPEED PRINTER
• 150 characters per second
• Up to 4 copies 8 wide
• Microprocessor controlled
• Prints All Graphics
• Full Formatting Capability

PERIPHERALS FOR PET

• 24K Memory Expansion \$499
• 16K Memory Expansion 399
• PET to RS232 Serial 169
• 2 Way Serial Communication 229
• Modem Board for PET 375
• Analog to Digital Board for 16 Devices 275
• Second Cassette Drive 99

SALE MINIMAX

The Minimax Series Computer is an integrated, compact unit containing the CPU, Disk Storage, 12" CRT, and Full Style Keyboard.

MINIMAX I—8 Megabyte \$4495
MINIMAX II—2.4 Megabyte \$5095

FEATURES:

- 2 Megahertz 6502 CPU
- 100K System RAM • High Risk Graphics (240 x 512) • Serial & Parallel I/O

NEW! CENTRONICS 704
\$1895 List \$2500

- 110 cps B-Directional • Up to 13" Paper Width • 9 x 9 Matrix
- Upper/Lower Case • Tractor Feed • RS-232C Serial Interface

Great PET Software

DATABASE MANAGEMENT SYSTEM—Six modules comprising 40K of programming allows you to: create, edit, delete, display, print, sort, merge, etc.—databases of up to 10,000 records. Printer routines included. 60 Pages of documentation for 16-32K PET and 2040 Dual Disk.
Cost \$70.95

KRAM—Keyed Random Access Method—The new, ultra-fast access method for the PET Disk, provides keyed retrieval/storage of data. In either direct or sequential mode, by either full or partial key values. Written in 6502 machine code. Eliminates the need for "Sort" routines...
Cost \$70.95

apple

11 Megabyte Hard Disk For Apple \$4995

APPLE II PLUS ONLY \$1195

A complete self-contained computer system with APPLESOFT floating point BASIC in ROM. Full ASCII keyboard in a light weight molded carrying case.

Features include:

- auto-start ROM • Hi-Res graphics and 15 color video output.
- Expandable to 48K.

Supertalker \$279	Micromodem \$379
Disk 595	Programmer's Aid 50
Add-on Disk 495	Speechlab 229
Pascal Card 495	Communication Card 225
Business Software 625	Modem 200
Monitor 159	EPROM Programmer 100
Printer Card 190	Graphics Tablet \$795

CompuColor II

COMPUCOLOR II Disk-Based Model 3 Advanced hardware and software technology gives you:

- 13" Color Display
- Advanced Color Graphics
- 51K Disk Built-In
- 16K ROM Operating System
- 8K RAM User Memory
- 4K RAM Refresh
- 8080A Microcomputer
- RS-232C I/O

ANDERSON JACOBSON 841 I/O Terminal ideal for word processing and small businesses.

- ASCII Code
- 15 CPS Printout
- High Quality Selectric Printing
- Reliable heavy duty mechanism
- Completely Refurbished by A.J.
- Service in 15 Major Cities.

Parallel \$1130
Serial \$1230

NEW! XYMEX

1000 with QUADRA-PITCH \$2495

10, 12, 15 Pitch & Proportional Spacing

The XYMEX HY-Q 1000 is "Tomorrow's Printer"—with virtually every advancement built in as standard. No other options are required. Its versatility matches your output format - and - it can be used as an off-line typewriter.

RADIO SHACK • PET • SORCERER • APPLE • COMPUCOLOR • ETC.

PRINTERS • PRINTERS • PRINTERS

The COMPUTER FACTORY'S extensive inventory and wide selection of computer CENTRONICS 779 \$1095
CENTRONICS 730 795
TRENDCOM 100 375
TRENDCOM 200 595
PAPER TIGER 440 895
XEROX 1740 2810

ATARI 800 Personal computer **Only \$949**

ATARI 400 Personal Computer **Only \$529**

TEXAS INSTRUMENTS TI-99/4 HOME COMPUTER

Only \$1150 Includes 13" Color Monitor!

Over 1000 software tapes, books, disks on display. Come in and browse.

FREE \$35 of Software with purchase of any computer on this page.

Min Credit Card Order \$75

Open Mon.-Fri. 10-6 Sat. 10-4

VISA

N.Y. residents add 8% sales tax
• Same day shipment on prepaid and credit card orders • Add \$5 shipping fee computers, \$3 for boards
• \$1 each cassette tape

TO ORDER CALL (212) 687-5000 (46th St.)

The COMPUTER FACTORY 485 Lexington Avenue 750 Third Avenue New York, N.Y. 10017

Foreign order desk • Telex 640055

Learn to program your microcomputer using Assembly Language

Assembly Language Programming primers for these six microprocessors

Each book explains assembly language programming, describes the functions of assemblers and assembly instructions, and discusses basic software development concepts. A special section on structured programming complements the many practical programming examples, which range from simple memory load loops to complete rudimentary design projects. Z8000 ALP by Adam Osborne; all others by Lance Leventhal.



The 8086 Book

This June, Osborne/McGraw-Hill will release the first of a new series, **The 8086 Book** by Russell Rector. A handbook for all 8086 users, this book includes basic 8086 programming instructions, a thorough analysis of the 8086 instruction set, and detailed hardware and interfacing guides that reveal the full power of the 8086 multiprocessing capabilities. Check the box in the order form below to be sent **The 8086 Book** contents and order information.

COMING in JULY

Z8000

and COMING SOON

6809

In each book you'll find:

- * Over 80 programming examples tailored to your microcomputer, with source program, object code, flowcharts, and explanatory text.
- * Each instruction fully explained
- * Assembler conventions
- * I/O devices and interfacing methods
- * How to program the interrupt system

Table of Contents: Introduction to Assembly Language Programming; Assemblers; The Assembly Language Instruction Set; Simple Programs; Simple Program Loops; Character Coded Data; Code Conversion; Arithmetic Problems; Tables and Lists; Subroutines; Input/Output; Interrupts; Problem Definition and Program Design; Debugging and Testing; Documentation and Redesign; Sample Projects.

Don't forget our other ALP Books

Z80 - 6800 - 8080A/8085 - 6502

Order Form

Book	Price	Quantity	Amount
6502 Assembly Language Programming	\$12.50		
Z80 Assembly Language Programming	\$12.50		
6800 Assembly Language Programming	\$12.50		
8080A/8085 Assembly Language Programming	\$12.50		
California residents tax			
Shipping			
TOTAL			

Calif. residents add 6% sales tax.
S.F. BART residents add 6-1/2% sales tax.

SHIPPING (Shipping for large orders to be arranged)
 All foreign orders \$4.00 per item for airmail
 \$0.75 per item 4th class in the U.S. (allow 3-4 weeks)
 \$1.25 per item UPS in the U.S. (allow 10 days)
 \$2.50 per item special rush shipment in the U.S.
 For faster shipment or credit card, phone (415) 548-2805

- Please notify me when The 8086 Book is available.
- Please notify me when 6809 ALP is available.
- Please notify me when Z8000 ALP is available.

Name: _____
 Address: _____
 City: _____ State: _____
 ZIP: _____ Phone: _____

 OSBORNE/McGraw-Hill

630 Bancroft Way, Dept. B3
 Berkeley, California 94710
 (415) 548-2805 • TWX 910-366-7277



S1069

have one not work.

In conclusion, if you already have the *8080 Software Gourmet Guide and Cookbook*, just buy Scelbi's *Z80 Instruction Handbook*; the two together will give you almost everything in this volume, and you will save the cost of a floppy disk or two. If you do not have the 8080 volume, then the *Z80 Software Gourmet Guide and Cookbook* could be a good addition to your

assembler reference library.

John A Lehman
716 Hutchins #2
Ann Arbor MI 48103

BASEX

Paul Warme
BYTE Books
Peterborough NH, 1979
softcover, 97 pages
\$8

BASEX is an interactive compiler written for the 8080 family of computers. The book is complete with bar code, source listing and machine code listing.

Many language systems for microprocessors are written as interactive interpreters which do not convert the sentence-like statements of the language into machine code, but simply perform the command in each line of source program as the line is

scanned. In short, the language system interprets statements and performs tasks via interpretative run-time routines. In contrast, a compiler does not immediately execute statements in source code, but translates the source code into object code which can be directly executed by the machine.

There are advantages to both approaches in implementing a computer language, and I simply will refer the reader to the almost never-ending discourse in any of the computer journals for the facts and opinions. My bias is towards use of compilers.

When you purchase BASEX, you receive a well-written document describing an interesting approach to compiler construction. First, you get a complete assembler source listing of all the run-time routines that add, subtract, multiply, and divide; and that perform memory block-move, memory read, memory write, memory compare, accumulator OR operations; plus routines that perform input and output. You also get a listing of the BASEX compiler and a relocating loader, both written in BASEX. What you do not get is floating point math, error messages, error recovery operations, and mass storage operations.

I bought BASEX to see if it could be used in a business environment. It simply is not sophisticated enough for business use, but it is ideal for text editors, disk operating systems, and other applications where high speed, simple math, and well-defined static applications prevail. If serious use of BASEX is contemplated, the following should be developed:

- mass storage capabilities;
- error intercept and recovery routines;
- a trace function for debug purposes;
- a binary look up routine for the symbol table; and
- routines to let the compiler perform memory



Cat.[™] Someday there won't be a phone without one.

The only way to realize the full potential of your small business or personal computer is to tie it in with other computers. And the best way to do that is with a Cat acoustic modem.

A Cat modem lets your computer talk face to face with any other compatible computer or terminal within reach of your phone, over standard telephone lines.

You can work at home using the computer at your office. Send or receive data from anywhere. Or swap programs.

Fast, accurate, reliable—and only \$189.

Cat. Someday there won't be a computer without one.

**Cat by
Novation**

Tie your computer into the world.

Call for details

(800) 423-5410

In California (213) 996-5060



Available at Hamilton/Avnet, Kierulff Electronics, Byte Shops, Computerland, and your local computer store.

Novation, Inc., 18664 Oxnard Street, Tarzana, California 91356

BLINK.

At first it appears to be an IBM Selectric™. It is! A standard keyboard, familiar operation that does such a good job on day-to-day typing. Look, closer. There are extra controls: CONTROL ESCAPE DELETE REPEAT ABORT TEST. The full functions of a communications terminal. It is! Connect the cable to your system's RS232C connector and quick as a blink you can communicate. Input and receive? That's right. It's a printer, too. And, what a printer! Sharp, neat, clear impressions. IBM

Selectric™ quality, whether typed by hand or by your computer. Typewriter yes, communicator yes, printer yes. All three beautifully packaged in a single machine for \$1595.

Buy one, today, and expand your present system with the flick of a switch. In the blink of an eye.

Western I/O



Western I/O 7750 E. Redfield Road Scottsdale, Arizona 85260 Area Code (602) 948-3162

Now—interact with your computer with WILEY SELF-TEACHING GUIDES

Popular, inexpensive paperbacks for homes, offices, and schools

Over 150,000 copies sold!

BASIC, 2nd Edition

Bob Albrecht, LeRoy Finkel, & Jerald R. Brown
Readers of all ages have used this manual to teach themselves BASIC and apply it to decision making and problem solving in many fields including business, data processing, economics, statistics, education, psychology, and the humanities. This popular guide requires no special math or science background nor even access to a computer.

325 pp. 1978 \$7.95 paper

"May possibly be the best bargain in the computer industry."
—Computers in Education

BASIC FOR HOME COMPUTERS

Bob Albrecht, LeRoy Finkel, & Jerald R. Brown
In just days you can get right down to programming in micro-soft BASIC—and perform both practical applications and fun and games. 336 pp. 1978 \$7.95 paper

"Takes you from knowing almost nothing to knowing almost everything... Albrecht et al. have done it again!"—Kilobaud

INTRODUCTION TO DATA PROCESSING, 2nd Edition

Martin L. Harris in consultation with Nancy B. Stern
Here's a clear introduction to how computers work, what data processing is, how it's organized, types of equipment used, and how a data processing system is designed. This new updated edition incorporates all recent advances in telecommunications, microcomputers, integrated circuits, and intelligent terminals as well as full discussion of computer system uses. 352 pp. 1979 \$5.95 paper

Coming In April—

TRS-80 BASIC

Bob Albrecht, Don Inman, & Ramon Zamora
Packed with games, graphics, and practical applications, this eagerly awaited guide leads you step by step to maximum use and enjoyment of your new TRS-80.

336 pp. April 1980 \$8.95 paper

"The book is OUTSTANDING... the best thing to happen to LEVEL II owners."—TRS-80 Monthly Newsmagazine

STRUCTURED COBOL

Ruth Ashley
This new guide to the computer language most widely used in business emphasizes structured programming to help make programs easier to understand and check... and less costly to debug. Covers the structure of COBOL, use of unit record files, control logic, tape and disk files, sequential files, random access files, and many other programming techniques. 320 pp. April 1980 \$8.95 paper

Wiley Self-Teaching Guides also teach FORTRAN, Job Control Language, Flowcharting, ATARI BASIC, and Background Math for Computer Problem Solving.

Look for them at your favorite bookstore or computer shop or write to Pam Byers, Dept. 7600.



JOHN WILEY & SONS, Inc.

605 Third Avenue
New York, N.Y. 10016

In Canada: 22 Worcester Road, Rexdale, Ontario
Prices subject to change without notice.

0-7600

management for line insert and delete.

Linking BASEX to CP/M

BASEX may be run as a command (COM) file under CP/M. First, enter the entire BASEX compiler into your computer. If you do not have a bar-code reader, prepare yourself for a three-hour exercise in data entry. Next, move the code residing at hexadecimal locations 0000 thru 0103 to hexadecimal locations 2000 thru 2103. Then place a JMP

instruction at location 0100 which causes a branch to hexadecimal location 2105 (object code C3 05 21). At memory location 2105 assemble the following:

```

MOVIT LXI H,2000H
      LXI D,0H
      MOV A,M
      STAX D
      INX D
MOV   A,D
      CPI 01H
      JNZ MOVIT
      MOV A,E
      CPI 03H
      JNZ MOVIT
      JMP 0H
  
```

Follow the instructions in the BASEX book for changing I/O addresses in BASEX. Now save BASEX with CP/M as "BASEX.COM". Now type BASEX. You should be able to start using BASEX, unless you made an error somewhere.

I would be interested in hearing other readers' experiences with the BASEX compiler.

Wayne F Miller
905 Fairmont
Jefferson City MO 65101

BYTE's Bits

Wozniac Receives 1979 ACM Grace Murray Hopper Award

Stephen Wozniac, Vice President of Research and Development for the Apple Computer Co, Cupertino, California, received the Association for Computing Machinery (ACM) Grace Murray Hopper Award for "his many contributions to the rapidly growing field of personal computing and, in particular, to the hardware and software for the Apple Computer." The award acknowledges his work on programmable pocket calculators which he accomplished while employed by Hewlett-Packard. The annual award is given in recognition of achievements in the computer field made before attaining the age of 30. The \$1000 award is donated by Sperry Univac, a longtime employer of Dr Hopper.

Real-Time BASIC Available Free

If you are doing process control applications in real time, you should investigate Lawrence Livermore Laboratory's (LLL) version of BASIC. It was developed with public funds, hence copies are available for just the duplication fee. Contact Harry Edwards, National Software Center, 9700 S Cass Ave, Bldg 221, Argonne IL 60439.

LLL BASIC was designed to run on an 8080-based system. The interpreter can execute BASIC source code contained in a read-only memory. A companion compiler can produce faster and more efficient object code. LLL BASIC has machine control statements and works with the Advanced Micro Devices AMD9511 mathematical-function integrated circuit for faster execution time. ■

64KB RAM MEMORIES

LSI-11 - \$750.00 ● SBC 80/10 - \$750.00
S-100 - \$750.00 ● 6800 - \$750.00 ● 6800-2 - \$995.00

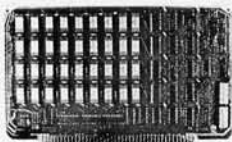

CI-6800-2 64K x 9



CI-S100 64K x 8

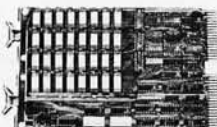

CI-1103 32K x 16

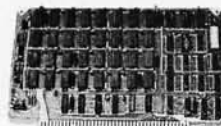

CI-6800 64K x 8



CI-8080 64K x 8

CI-6800-2 — 16KB to 64KB. Plugs directly into Motorola's EXORciser I or II. Hidden refresh up to 1.5 Mhz. Cycle stealing at 2 Mhz. Addressable in 4K increments with respect to VXA or VUA. Optional on Board Parity. 64K x 9 \$995.00.

CI-S100 — 16KB to 64KB. Transparent hidden refresh. No wait states at 4 Mhz. Compatible with Alpha Micro and all Major 8080, 8085 and Z80 Based S100 Systems. Expandable to 512 K bytes thru Bank Selecting. 64K x 8 \$750.00.

CI-1103 — 16KB to 64KB on a single dual height board. On board hidden refresh. Plugs directly into LSI 11/2, H11 or LSI 11/23. Addressable in 2K word increments up to 256 K Bytes. 8K x 16 \$390.00. 32K x 16 \$750.00.

CI-6800 — 16KB to 64KB on a single board. On board hidden refresh. Plugs directly into EXORciser I and compatible with Rockwell's System 65. Addressable in 4K increments up to 64K. 16K x 8 \$390.00. 64K x 8 \$750.00.

CI-8080 — 16KB to 64KB on a single board. Plugs directly into MDS 800 and SBC 80/10. Addressable in 4K increments up to 64K. 16 KB \$390.00. 64K \$750.00.

Test and burned-in. Full year warranty.



Chrislin Industries, Inc.

Computer Products Division

31352 Via Colinas • Westlake Village, CA 91361 • 213-991-2254

Ten reasons why your floppy disk should be a BASF FlexyDisk®.



More than four decades of experience in magnetic media – BASF invented magnetic recording tape, the forerunner of today's wide range of magnetic media, back in 1934, and was the first independent manufacturer of IBM-compatible floppy disks.

Tough Tyvek sleeve – no paper dust, no static electricity.

Special self-cleaning jacket and liner help eliminate data errors and media wear and tear.

Packaging to suit your requirements – standard flip-top box, Cassette 10® storage case, or bulk pack.

Center hole diameter punched to more accurate standards than industry specifications, for top performance.

100% certification – every single disk is tested at thresholds 2-3 times higher than system requirements, to be 100% error-free.

Bi-axially oriented polyester substrate – for uniform and reliable performance year after year.

For the name of your nearest supplier, write BASF Systems, Crosby Drive, Bedford, MA 01730, or call 617-271-4030.

Cross-linked oxide coating – for low head wear and long trouble-free media life.

Total capability – one of two manufacturers in the world that makes both 8" and 5.25" models, has tape and disk experience, and manufactures floppy disk drives.

Double lubrication – lubricants both in the formula and on the disk surface, to minimize media wear due to head friction.



BASF

Floppy Disks Mag Cards Cassettes Computer Tapes Disk Packs Computer Peripherals

Clubs and Newsletters

International Computer Chess Association

The International Computer Chess Association was established at the Second World Computer Chess Championship in Toronto in 1977. It currently has about 200 members, and publishes

the *ICCA Newsletter* three or four times per year. The cost of membership for a single year is \$10 in US funds. Contact Professor Ben Mittman, Vogelback Computer Center, Northwestern University, Evanston IL 60201.

Lincoln Micro-Computer Club

This club has changed its name from the Lincoln Computer Club to the present name. They meet on the first Wednesday of each month at 7 PM at the State Federal Savings and Loan on

40th St and South St in Lincoln, Nebraska. The club is open to users and owners of all types of microcomputers. Yearly subscription fees are \$5. Contact Hubert Paulson Jr, 1209 Garber Ave, Lincoln NE 68521.

Micro

This club is open to users and owners of microcomputers. The members meet at 9:30 AM on the second Saturday of each month at the NWTI in Green Bay, Wisconsin. Contact Stuart Mong, 1824 Glenview Ave, Green Bay WI 54303.

Big savings from AJ on TTYs, couplers, and modems.

Now available from dealers nationwide.

Off-lease equipment, refurbished by AJ at the factory.

ASR 33 — \$725 (Qty. 1)

KSR 33 — \$595 (Qty. 1)

- 30-day parts/labor warranty*
- Tape punch/reader (ASR only)
- Send and receive
- Pedestal mounted

AJ Couplers/Modems

- The Cadillacs of the industry
- Some models under \$100
- 30-day parts/labor warranty*
- Variety of models — up to 1200 bps
- Fast delivery
- Nationwide AJ service network

Quantities limited and first-come, first-served.

So call toll-free now: (800) 538-9721.

California residents call (408) 263-8520.

Prices subject to change without notice.

*Details available on request.



**ANDERSON
JACOBSON**

Change in Meeting Place for Chicago Area Computer Hobbyist's Exchange (CACHE)

The CACHE group meets at the same time but now at the DeVry Technical Institute, 3300 N Campbell, Chicago IL. This is one block west of Western Ave.

New Information on the AIM-65 Newsletter

For information on AIM-65, contact Target, c/o Don Clem, RR 2, Spencerville OH 45887. Inquiries should include a self-addressed, stamped envelope and all orders must be prepaid. Sample copies are \$1 each; a bi-monthly, one year subscription is \$5 in the US and Canada and \$12 (airmail) elsewhere.

CP/M Users Group

The Washington CP/M Users Group generally meets on the third Wednesday of each month at members' homes. Most members own S-100 disk systems with a variety of microprocessors, disks, terminals, printers, and boards. CP/M is the format of software exchange and the subject of frequent meetings. Annual dues are \$6, primarily to cover postage. Contact Winston Riley III, 7315 Wisconsin Ave, Washington DC 20014.

PUTTING IT ALL TOGETHER



INVENTORY CONTROL

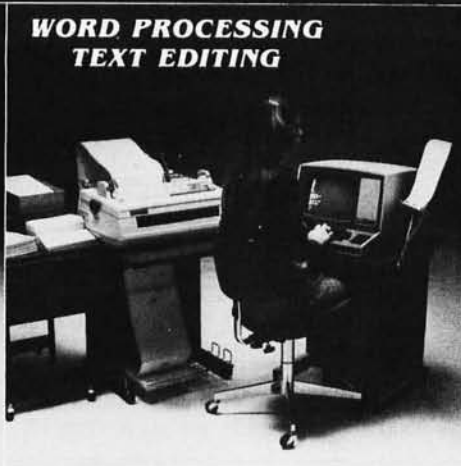

**WORD PROCESSING
TEXT EDITING**

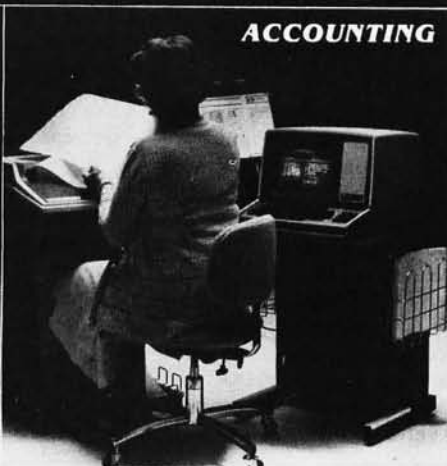

ACCOUNTING

Four-User North Star Horizon with 29 Megabyte Hard Disk Interface

INCLUDING:

- 48K RAM per user
- Two 360K 5 1/4" disk drives (as many as four, optional)
- Two printers:
 - One Texas Instruments TI 810 dot matrix, 150 character per second, bi-directional, tractor feed printer with all available options
 - One NEC Spinwriter 5510 document quality, full-character printer with friction feed and tractor feed
- Deluxe printer stands and paper trays for both printers

One Discus 29 megabyte (26 megabyte formatted) Winchester technology, fixed hard disk unit with controller, cabinet, power supply, all cables, ports and connectors, completely interfaced to DOS and BASIC, CP/M* PASCAL and Micro Mike's interrupt-driven, bank-switching timesharing (as many as four 29 megabyte hard disk units, seven users, optional)

One custom computer/hard disk desk, Executive model, three CRT stands, thirty 5 1/4" diskettes

*Micro Mike's, Incorporated Program Library Membership, including:

- General Ledger
- Accounts Receivable
- Accounts Payable
- Inventory
- CSUB (Common SUBroutines)
- Payroll
- Mail list
- Word Processing/Text Editing
- Project Cattle Profits
- Timesharing
- DOSCHG (eight inch drive interface to DOS and BASIC)
- Commodities Charts
- and many outstanding utilities programs and public domain software

*All programs available separately.
Total System \$23,719

Micro Mike's, Inc. thoroughly "burns in" and tests all systems delivered as *integrated hardware/software systems*, under timesharing conditions, the ultimate test of a complete computer system. This "burning-in" and testing procedure continues, non-stop, for a minimum of three days and nights, insuring the end user the highest quality, trouble-free integrated hardware/software system possible.

Micro Mike's, Inc. will, for a fee, deliver and set up a system anywhere in the USA. Personal user training and/or custom programming is also available.

*CP/M is a registered trademark of Digital Research.

*Complete North Star
Horizon Service Center
Call or write for
descriptive literature*

making technology uncomplicated . . . for People



Discus 29 megabyte Winchester technology fixed, sealed hard disk units completely interfaced to DOS and BASIC, CP/M and PASCAL for most S-100 buss computer systems, ready to go, including controller, cabinet and power supply, all cables, ports and connectors \$5,495

Additional 29 megabyte drive, cabinet and power supply \$4,495



Micro Mike's, Inc. offers a complete selection of top-notch business software. Among comprehensive programs are:

- Time and Expense package for accountants, attorneys, and other professionals
- Patient Daily Record Program (Doctor/Patient Ledger) for Physicians
- Land Subdivision package
- Pharmacy
- Motel Reservation with Night Audit
- Banker's Trust
- Feedlot
- Oil/Gas Producer's package
- many more



IN STOCK:
North Star Horizons
Discus double density or quad capacity eight inch drives for S-100 buss systems
Printers: Texas Instruments TI 810, NEC Spinwriter, IDS-440 Paper Tiger
Armadillo Armor 5 1/4" protective diskette shipping cartons . . . \$45 per hundred
Used Intertec Intertube CRTs, as-is condition, close-out \$495

Mike's

MICRO MIKE'S, INCORPORATED
905 South Buchanan
Amarillo, Texas 79101 U.S.A.
Telephone (806) 372-3633

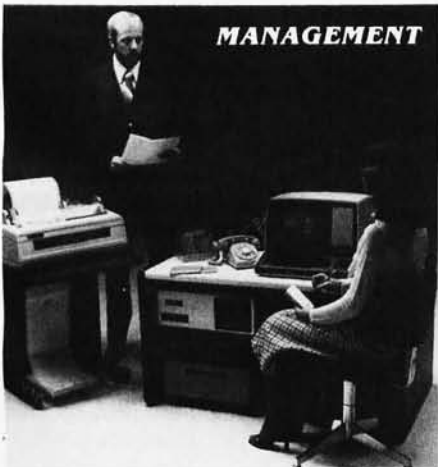

MANAGEMENT

Wyoming Valley Computer Club

The TRS-80 users club in Pennsylvania is seeking new members. The Wyoming Valley Computer Club meets on the second Tuesday of every month at 7:30 PM at the Artco Electronics building in Kingston, Pennsylvania. There is a monthly newsletter for all members. For more information, contact Art Prutzman, Artco Electronics, 302 Wyoming Ave, Kingston PA 18704.

Apple Educators' Newsletter

This publication is devoted to educators and researchers using the Apple II system and other compatible systems. Articles concerning educational programs, grants for microcomputers and education, exchanges of ideas using computers in education, and general items are featured. Contact *Apple Educators' Newsletter*, 9525 Lucerne, Ventura CA 93003.

Apple Users Group in Arlington TX

The Fort Worth Apple Users Group (FWAUG) has been created to help users, owners and beginners understand and fully utilize their Apple II systems. The group meets on the third Sunday of each month at 3 PM at the CompuShop Store, 6353 Camp Bowie, Fort Worth TX. The group has a software program exchange and a library for members. The *FWAUG*

Newsletter is an eight-page monthly publication, sent to all members. Dues are \$9 per year. For more information, contact FWAUG, c/o Lee Meador, 1401 Hillcrest Dr, Arlington TX 76010.

OSI Superboard Club

This newsletter contains programs, ideas, technical data, hints and suggestions on the use of Ohio Scientific Challenger IP and Superboards. The newsletter will be published every two months. Send a self-addressed business envelope and \$1 for further information to Superboard Club, POB 55, Agincourt, Ontario M1S 3B4 CANADA.

Dental Computer Newsletter

The DCN is a group of dentists, physicians and office management people that have interests in computers. DCN offers members a monthly newsletter, software exchange, advice and experience, and access to members in specific areas. Annual membership dues are \$12 per year. Back issues of the *Dental Computer Newsletter* are \$1 each and \$10 per year. Membership and equipment listings are \$5. Commercial software lists and DCN software exchange lists are free with a \$0.28 stamped, self-addressed envelope. Contact *Dental Computer Newsletter*, E J Neiburger, editor, 1000 North Ave, Waukegan IL 60085.

Computer Law Journal

Each issue of the *Computer/Law Journal* is devoted to a single topic of computer law, and contains feature articles by experts in the field, a comprehensive bibliography on the featured topic, case digests of all significant court and administrative agency decisions on the topic, and other reference materials. Topics have included patent protection of computer software and computer-assisted legal research. Future issues will

IS YOUR BUSINESS READY FOR A COMPUTER?



Here's the information you'll need to make an informed decision.

Designed for the businessman who knows very little about a computer, this new course will give you the information and understanding you need to intelligently evaluate if the cost of a computer is worth the benefits.

THE COMPUTER AND HOW IT WORKS describes the types of memory, storage media, input/output devices, and types of software in understandable terms. A description of different applications software clarifies the typical tasks that a computer may perform.

ORGANIZING A DATA PROCESSING DEPARTMENT describes the advantages of full time employees vs. consultants, and when each

is best for your company.

HOW TO SELECT A COMPUTER helps you define your specific requirements for hardware, peripherals, and software now and for the future.

ALTERNATIVES of owning vs. time sharing, vs. service bureaus and the common advantages/disadvantages of each.

Introduction to Computers is 160 pages of text with 3 tape cassettes for only \$49.95.

Developed by Vermillion & Assoc. whose products are used by over 5000 companies & 15 computer manufacturers.

An uninformed decision will cost much more.

VERTEC

21250 Califa Street, Woodland Hills, California 91367, (800) 423-5205 toll free (213) 999-5753 collect in Calif.

NAME _____ TITLE _____
COMPANY _____
ADDRESS _____
CITY _____ STATE _____ ZIP _____
Master Charge/Visa Card No. _____ Expiration Date _____
Signature _____

DEALER INQUIRIES INVITED

By Netronics

ASCII/BAUDOT, STAND ALONE

Computer Terminal

COMPLETE FOR ONLY \$149.95



The Netronics ASCII/BAUDOT Computer Terminal Kit is a microprocessor-controlled, stand alone keyboard/terminal requiring no computer memory or software. It allows the use of either a 64 or 32 character by 16 line professional display format with selectable baud rate, RS232-C or 20 ma. output, full cursor control and 75 ohm composite video output.

The keyboard follows the standard typewriter configuration and generates the entire 128 character ASCII upper/lower case set with 96 printable characters. Features include onboard regulators, selectable parity, shift lock key, alpha lock jumper, a drive capability of one TTY load, and the ability to mate directly with almost any computer, including the new Explorer/85 and ELF products by Netronics.

The Computer Terminal requires no I/O mapping and includes 1k of memory, character generator, 2 key rollover, processor controlled cursor control, parallel ASCII/BAUDOT to serial conversion and serial to video processing—fully crystal controlled for superb accuracy. PC boards are the highest quality glass epoxy for the ultimate in reliability and long life.

VIDEO DISPLAY SPECIFICATIONS

The heart of the Netronics Computer Terminal is the microprocessor-controlled Netronics Video Display Board (VID) which allows the terminal to utilize either a parallel ASCII or BAUDOT signal source. The VID converts the parallel data to serial data which is then formatted to either RS232-C or 20 ma. current loop output, which can be connected to the serial I/O on your computer or other interface, i.e., Modem.

When connected to a computer, the computer must echo the character received. This data is received by the VID which processes the information, converting to data to video suitable to be displayed on a TV set (using an RF modulator) or on a video monitor. The VID generates the cursor, horizontal and vertical sync pulses and performs the housekeeping relative to which character and where it is to be displayed on the screen.

Video Output: 1.5 P/P into 75 ohm (EIA RS-170) • **Baud Rate:** 110 and 300 ASCII • **Outputs:** RS232-C or 20 ma. current loop • **ASCII Character Set:** 128 printable characters—

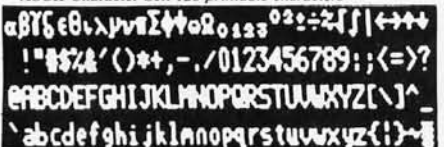

BAUDOT Character Set: ABCDEFGHIJKLMNOPQRSTUVWXYZUVWXY Z-; *3 \$ # () , . / 0 1 2 3 4 5 6 7 8 9 : ; < = ? @ [\] ^ _ ` { | } ~

Continental U.S.A. Credit Card Buyers Outside Connecticut
CALL TOLL FREE 800-243-7428

To Order From Connecticut Or For Technical Assistance, Etc. Call (203) 354-9375

Netronics R&D Ltd., Dept. PE-9
333 Litchfield Road, New Milford, CT 06776

Please send the items checked below—
 Netronics Stand Alone ASCII Keyboard/Computer Terminal Kit, \$149.95 plus \$3.00 postage & handling.
 Deluxe Steel Cabinet for Netronics Keyboard/Terminal In Blue/Black Finish, \$19.95 plus \$2.50 postage and handling.
 Video Display Board Kit alone (less keyboard), \$89.95 plus \$3 postage & handling.
 12" Video Monitor (10 MHz bandwidth) fully assembled and tested, \$139.95 plus \$5 postage and handling.
 RF Modulator Kit (to use your TV set for a monitor), \$8.95 postpaid.
 5 amp Power Supply Kit In Deluxe Steel Cabinet (±8VDC @ 5 amps, plus 6-8 VAC), \$39.95 plus \$2 postage & handling.
Total Enclosed (Conn. res. add sales tax) \$ _____
By—
 Personal Check Cashiers Check/Money Order
 Visa Master Charge (Bank # _____)
Acct. # _____
Signature _____ Exp. Date _____
Print Name _____
Address _____
City _____
State _____ Zip _____
 Send Me More Information

Start Computing For Just \$129.95 With An 8085-Based Professional Computer Kit—

Explorer/85

100% compatible with all 8080A and 8085 software & development tools!

No matter what your future computing plans may be, Level "A"—at \$129.95—is your starting point.

Starting at just \$129.95 for a Level "A" operating system, you can now build the exact computer you want. Explorer/85 can be your beginner's system, OEM controller, or IBM-formatted 8" disk small business system... yet you've never forced to spend a penny for a component or feature you don't want and you can expand in small, affordable steps! Now, for just \$129.95, you can own the first level of a fully expandable computer with professional capabilities—a computer which features the advanced Intel 8085 cpu, thereby giving you immediate access to all software and development tools that exist for both the 8085 and its 8080A predecessor (they are 100% software compatible)—a computer which features onboard S-100 bus expansion—plus instant conversion to mass storage disk memory with either 5-1/4" diskettes or standard IBM-formatted 8" disks.

For just \$129.95 (plus the cost of a power supply, keyboard/terminal and RF modulator, if you don't have them already), Explorer/85 lets you begin computing on a significant level... applying the principles discussed in leading computer magazines... developing "state of the art" computer solutions for both the industrial and leisure environment.

Level "A" Specifications

Explorer/85's Level "A" system features the advanced Intel 8085 cpu, an 8355 ROM with 2k deluxe monitor/operating system, and an 8155 ROM-I/O—all on a single motherboard with room for RAM/ROM/PROM/EPROM and S-100 expansion, plus generous prototyping space.

(Level "A" makes a perfect OEM controller for industrial applications and is available in a special Hex Version which can be programmed using the Netronics Hex Keypad/Display.)

PC Board: glass epoxy, plated through holes with solder mask • I/O: provisions for 25-pin (DB25) connector for terminal serial I/O, which can also support a paper tape reader... provision for 24-pin DIP socket for hex keypad/display... cassette tape recorder input... cassette tape recorder output... speaker output... LED output indicator on SOD (serial output) line... printer interface (less drivers)... total of four 8-bit plus one 6-bit I/O ports • Crystal Frequency: 6.144 MHz • Control Switches: reset and user (RST 7.5) interrupt... additional provisions for RST 5.5, 6.5 and TRAP interrupts onboard • Counter/Timer: programmable, 14-bit binary • System RAM: 256 bytes located at F800, ideal for smaller systems and for use as an isolated stack area in expanded systems... RAM expandable to 64k via S-100 bus or 4K on motherboard.

System Monitor (Terminal Version): 2k bytes of deluxe system monitor ROM located at F000 leaving 0000 free for user RAM/ROM. Features include tape load with labeling... tape dump with labeling... examine/change contents of memory... insert data... warm start... examine and change all registers... single step with register display at each break point, a debugging/training feature... go to execution address... move blocks of memory from one location to another... fill blocks of memory with a constant... display blocks of memory... automatic baud rate selection... variable display line length control (1-255 characters/line)... channelized I/O monitor routine with 8-bit parallel output for high speed printer... serial console in and console out channel so that monitor can communicate with I/O ports.

System Monitor (Hex Version): Tape load with labeling... tape dump with labeling... examine/change contents of memory... insert data... warm start... examine and change all

Netronics R&D Ltd., Dept. RE 10
333 Litchfield Road, New Milford, CT 06676

Please send the items checked below—
 Explorer/85 Level "A" Kit (ASCII Version), \$129.95 plus \$3 p&h.
 Explorer/85 Level "A" Kit (Hex Version), \$129.95 plus \$3 p&h.
 8k Microsoft BASIC on cassette tape, \$64.95 postpaid.
 8k Microsoft BASIC in ROM Kit (requires Levels "B", "D", and "E"), \$99.95 plus \$2 p&h.
 Level "B" (S-100) Kit, \$49.95 plus \$2 p&h.
 Level "C" (S-100 6-card expander) Kit, \$39.95 plus \$2 p&h.
 Level "D" (4k RAM) Kit, \$69.95 plus \$2 p&h.
 Level "E" (EPROM/ROM) Kit, \$5.95 plus 50¢ p&h.
 Deluxe Steel Cabinet for Explorer/85, \$49.95 plus \$3 p&h.
 ASCII Keyboard/Computer Terminal Kit (features a full 128 character set, upper & lower case, full cursor control, 75 ohm video output convertible to baudot output, selectable baud rate, RS232-C or 20 ma. I/O, 32 or 64 character by 16 line formats, and can be used with either a CRT monitor or a TV set (if you have an RF modulator), \$149.95 plus \$2.50 p&h.
 Hex Keypad/Display Kit, \$69.95 plus \$2 p&h.
 Deluxe Steel Cabinet for ASCII Keyboard/Terminal, \$19.95 plus \$2.50 p&h.
 Power Supply Kit (±8V @ 5 amps) in deluxe steel cabinet, \$39.95 plus \$2 p&h.
 Gold Plated S-100 Bus Connectors, \$4.85 each, postpaid.
 RF Modulator Kit (allows you to use your TV set as a monitor), \$8.95 postpaid.
 16k RAM Kit (S-100 Board expands to 64k), \$199.95 plus \$2 p&h.
 32k RAM Kit, \$329.95 plus \$2 p&h.
 48k RAM Kit, \$459.95 plus \$2 p&h.
 64k RAM Kit, \$589.95 plus \$2 p&h.
 16k RAM Expansion Kit (to expand any of the above up to 64k), \$139.95 plus \$2 p&h each.
 Intel 8085 cpu User's Manual, \$7.50 postpaid.
 Special Computer Grade Cassette Tapes, \$1.90 each or 3 for \$5, postpaid.
 12" Video Monitor (10 MHz bandwidth), \$139.95 plus \$5 p&h.
 North Star Double Density Floppy Disk Kit (One Drive) for Explorer/85 (includes 3 drive S-100 controller, DOS, and extended BASIC with per-



registers... single step with register display at each break point... go to execution address. Level "A" in the Hex Version makes a perfect controller for industrial applications and can be programmed using the Netronics Hex Keypad/Display.

Hex Keypad/Display Specifications

Calculator type keypad with 24 system defined and 16 user defined keys. 6 digit calculator type display which displays full address plus data as well as register and status information.

Level "B" Specifications

Level "B" provides the S-100 signals plus buffers/drivers to support up to six S-100 bus boards and includes: address decoding for onboard 4k RAM expansion select-able in 4k blocks... address decoding for onboard 8k EPROM expansion select-able in 8k blocks... address and data bus drivers for onboard expansion... wait state generator (jumper selectable), to allow the use of slower memories... two separate 5 volt regulators.

Level "C" Specifications

Level "C" expands Explorer's motherboard with a card cage, allowing you to plug up to six S-100 cards directly into the motherboard. Both cage and cards are neatly contained inside Explorer's deluxe steel cabinet. Level "C" includes a sheet metal superstructure, a 5-card gold plated S-100 extension PC board which plugs into the motherboard. Just add required number of S-100 connectors

Level "D" Specifications

Level "D" provides 4k or RAM, power supply regulation, filtering decoupling components and sockets to expand your Explorer/85 memory to 4k (plus the original 256 bytes located in the 8155A). The static RAM can be located anywhere from 0000 to EFFF in 4k blocks.

Level "E" Specifications

Level "E" adds sockets for 8k of EPROM to use the popular Intel 2716 or the TI 2516. It includes all sockets, power supply regulator, heat sink, filtering and decoupling components. Sockets may also be used for soon to be available RAM IC's (allowing for up to 12k of onboard RAM).

Order A Coordinated Explorer/85 Applications Pak!

- Experimenter's Pak (SAVE \$12.50)**—Buy Level "A" and Hex Keypad/Display for \$199.90 and get FREE Intel 8085 user's manual plus FREE postage & handling!
- Student Pak (SAVE \$24.45)**—Buy Level "A", ASCII Keyboard/Computer Terminal, and Power Supply for \$319.85 and get FREE RF Modulator plus FREE Intel 8085 user's manual plus FREE postage & handling!
- Engineering Pak (SAVE \$41.00)**—Buy Levels "A," "B," "C," "D," and "E" with Power Supply, ASCII Keyboard/Computer Terminal, and six S-100 Bus Connectors for \$514.75 and get 10 FREE computer grade cassette tapes plus FREE 8085 user's manual plus FREE postage & handling!
- Business Pak (SAVE \$89.95)**—Buy Explorer/85 Levels "A," "B," and "C" (with cabinet), Power Supply, ASCII Keyboard/Computer Terminal (with cabinet), 16k RAM, 12" Video Monitor, North Star 5-1/4" Disk Drive (includes North Star BASIC) with power supply and cabinet, all for just \$1599.40 and get 10 FREE 5-1/4" minidisettes (\$49.95 value) plus FREE 8085 user's manual plus FREE postage & handling!

Continental U.S.A. Credit Card Buyers Outside Connecticut
CALL TOLL FREE 800-243-7428

To Order From Connecticut Or For Technical Assistance, Etc. Call (203) 354-9375

sonalized disk operating system—just plug it in and you're up and running! \$699.95 plus \$5 p&h.
 Power Supply Kit for North Star Disk Drive, \$39.95 plus \$2 p&h.
 Deluxe Case for North Star Disk Drive, \$39.95 plus \$2 p&h.
 Experimenter's Pak (see above), \$199.90 postpaid.
 Student Pak (see above), \$319.85 postpaid.
 Engineering Pak (see above), \$514.75 postpaid.
 Business Pak (see above), \$1599.40 postpaid.
Total Enclosed \$ _____
(Conn. res. add sales tax) By—
 Personal Check M.O./Cashier's Check Visa Master Charge
(Bank # _____)
Acct. # _____
Signature _____ Exp. Date _____
Print Name _____
Address _____
City _____
State _____ Zip _____
 Send Me More Information

focus on computer related evidence, electronic funds transfer systems (EFTS), computer crimes and software taxation. The journal is published by the Center for Computer Law, 530 W 6th St, 10th Floor, Los Angeles CA 90014.

Scampus

Articles on bus structures, software, conversion circuits and other aspects of microcomputers are covered in this monthly newsletter. The

material comes from members of the group, so ideas and items are constantly needed and welcomed. There are no membership fees. A large supply of self-addressed, stamped envelopes are the only requirements. Write to *Scampus*, POB 132, Knob Noster MO 65336.

Another Apple II Club

The Adam and Eve Apple II Users Group meets at the

Madison Public Library in Madison, Wisconsin on the second Tuesday of each month at 7 PM. The group wants to exchange newsletters and software with other groups and receive advice on software. Adam and Eve is a subscriber of *The Source*, an information network. The dues are \$1 per meeting or \$3 per year for the *Adam & Eve Newsletter*. For more information, write to Adam and Eve, Apple II Users Group, 11 S Hancock St, Madison WI 53703. ■

BYTE's Bugs

Reversi Bug Makes Computer End Game Too Quickly

Several readers have pointed out a problem in the program published in "Programming Strategies in the Game of Reversi,"

November 1979 BYTE, page 66. In the program given in listing 1, the published code behaves in the following manner. Either after you have twice forced the computer into a position where it has no legal moves, it concedes the game and resigns; or after the computer has forced you into a moveless position twice, it declares itself to have won the game. Thanks to Darrell Pittman, Jack Guinnip, Delmer Hinrichs, Willy Verwoerd, and Betty Vogel for spotting the error.

Mr Guinnip deserves special praise, not only for spotting the error so quickly, but for doing it while working through the program with pencil and paper. He does not have access to a computer, as an inmate of the Sheridan Correctional Center in Illinois.

A simple patch suggested by Mr Pittman was published in the February 1980 BYTE on page 168, but readers may instead wish to make the somewhat more complete correction suggested by Mr Hinrichs. This includes a change to line 1382 and insertion of two other lines:

```
1382IF B(K) = THEN 1396
1396LET T3 = 0
1398RETURN
```

To improve the quality of play, Ms Vogel suggests that line 4200 be deleted, and that line 5310 be changed to read:

```
5310LET E(79) = 5
```

Peter B Maggs
2011 Silver Ct E
Urbana IL 61801 ■



D E S K
T O P
M I C R O
C O M P U T E R

Chrislin is First !!!

with deliveries of DEC's Desk Top Computers. Available with LSI 11/2 or LSI 11/23 CPU. Complete system totally enclosed within VT100 Video Terminal. Price \$4,500 with LSI 11/2 and 64K bytes or \$9,600 with LSI 11/23 and 256K bytes.

NOW Available — PDP 11/23 with 256 KB Memory \$8,900.

SPECIAL — LSI 11/2 and 32K x 16 Memory \$1,095.

10 MEGA BYTE Cartridge Disk System with Controller, RT11 compatible \$6,100.



Chrislin Industries, Inc.

Computer Products Division

31352 Via Colinas • Westlake Village, CA 91361 • 213-991-2254

OVER \$10,000 Value!

A Complete Business System

only \$5995

Price includes air freight shipping



VECTOR SYSTEM B, complete with Vector Mindless Terminal, 64K of RAM, Dual Floppy Disks (630 kilobytes of storage), and printer . . . so complete, you'll get all cables, box of 10 floppy disks, and *EVEN* a box of 3500 sheets of fanfold paper.

OVER \$3500 OF SOFTWARE INCLUDED!!! Digital Research's 2.0 CP/M Disk Operating System, Microsoft 80 BASIC Interpreter

AND one of the finest Business Packages — from Retail Science's PEACHTREE SOFTWARE, which includes:



- General Ledger
- Accounts Receivable
- Accounts Payable
- Inventory
- Payroll

System may be expanded for multi-user time-sharing data and word processing — up to 5 terminals — at nominal cost!

The System B doubles as an *excellent* Word Processing System.
Software at slight additional cost.

Third-party maintenance agreements being negotiated.

— WRITE FOR FREE CATALOG —

MiniMicroMart, Inc.

1618 James Street, Syracuse, NY 13203 (315) 422-4467 TWX 710-541-0431

"Gimme, gimme

There's only one small computer that can give you your heart's desire: Sorcerer™ from Exidy.

You don't mean to be greedy. But you're part of the new "Gimme" generation with big plans for the future. You expect your computer to be flexible enough to keep up. Only one system on the market today can do that: the Exidy Sorcerer.

Z80 & Plug-in ROM Software Packs

The Sorcerer uses the popular Z80 microprocessor as its "brain-center." Combine this with Exidy's plug-in ROM PACs™ and you've got a dynamite computing center right at your fingertips.

Our ROM PACs are special plug-in software cartridges that turn your Sorcerer into all sorts of different computer centers instantly. Just pop a STANDARD BASIC PAC™ into Sorcerer, and you're ready to program any application in high-level BASIC. Or plug in a DEVELOPMENT PAC™ and you have a low-cost Z80 software development system costing less than \$1700.

If words are your life, consider our WORD-PROCESSOR PAC™. It turns your Sorcerer into a modern text editing and formatting system for less than \$2600. This cartridge offers many benefits, including: automatic text wraparound, search and replace commands, and powerful macro programming.

And, to make it easy for you to put your own particular application software in ROM, we've also provided an EPROM PAC™. It has sockets for four user-supplied EPROMs with capacity up to 16K bytes.

S-100 Expansion & 128 User-Defined Symbols

The Sorcerer was created to withstand "Gimme" attacks. It's designed to be the hub of a busy computing operation now, and tomorrow when your demands increase or change.

Sorcerer's standard features, such as high-resolution

graphics, and the capability to define up to 128 of your own letters and symbols, give you an amazing flexibility to do things you simply can't accomplish with any other computer.

Our S-100 expansion unit lets you take advantage of the many useful S-100 peripherals currently available from dozens of manufacturers. And that includes everything from music and speech synthesizers for the hobbyist to appliance controllers for the home and the latest Winchester disk drives for small business computer applications.

It's also easy with Sorcerer to add on a printer, an acoustic coupler, or a modem, because our system has built-in parallel and RS232 Serial I/O ports (features normally offered as add-on options by most other small computer makers today).



Gimme, gimme!"

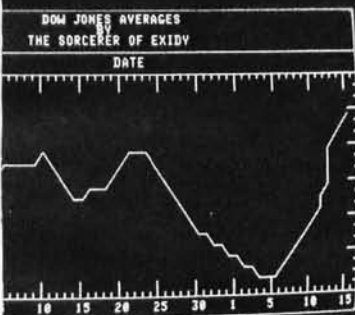

The best of Sorcerer

Hardware

The Sorcerer Computer: 16K RAM expandable to 48K. 4K ROM-resident operating system has built-in printer driver. 50-pin I/O connector for S-100 expansion. 25-pin parallel interface; 25-pin serial interface. Serial interface operates one or two cassette recorders. Graphic resolution of 240x512, 30 lines of 64 characters, 8x8-dot matrix. Character generator contains full ASC II set (upper & lower case), plus standard graphic symbols. User may define up to 128 characters. Keyboard is 63-key data processing type, plus 16-key numeric pad.

Price*

\$1295
(16K model)
\$1395
(32K model)
\$1495
(48K model)

Video Display: industrial grade 12-inch CRT (P31 phosphor).

\$ 499

Display Disk: single unit package containing two quad density dual floppy disks (630K bytes) with controller and 12-inch industrial grade CRT (P31 phosphor). Includes CP/M™ and Microsoft disk-extended BASIC.

\$2995

Floppy Disk Subsystems: single dual-density floppy disk (120K bytes) and controller in one package. Includes CP/M™ and Microsoft disk-extended BASIC.

\$1150

S-100 Expansion Unit: self-contained 10-amp power supply and motherboard with 6 card slots. Daisy chain units for more slots.

\$ 419

Software

Development PAC™

\$ 99

Word Processing PAC™

\$ 199

EPROM PAC™

\$ 49

Microsoft Disk-Extended BASIC

\$ 300

CP/M™ Operating System

\$ 145

*U.S. domestic prices only. Subject to change without notice. CP/M is a Registered Trademark of Digital Research.

Satisfy that urge

When you discover the many exciting ways Sorcerer can satisfy all your "Gimme" urges, you'll say: "I'm in sheer Exidy." For the name of your nearest dealer, or additional information, write or call our Marketing Communications Department.



Data Systems Division
390 Java Drive
Sunnyvale, CA 94086
(408) 734-9410

Circle 118 on inquiry card.

Product Reviews

Lucidata P-6800 Pascal

Phil Hughes, POB 2847, Olympia WA 98507

If you own a Southwest Technical Products Corporation (SwTPC) compatible system that runs Technical Systems Consultants' FLEX 2.0 or mini-FLEX operating system, you too can use Pascal. P-6800 Pascal is a substantial subset of full Pascal, and is designed for a SwTPC with FLEX or mini-FLEX.

I mailed my order for P-6800 Pascal, and thirteen days later the manual and disk arrived. I would consider this excellent delivery if Lucidata were in Kansas, but they are in the Netherlands! Even if it had not worked, I think I would have been amazed.

Two major items missing from this Pascal subset are the REAL and RECORD data types. Also missing are some of the capabilities of other directives. For example, the TYPE directive only supports enumerated types.

Looking at the capabilities in a more positive light, files, procedures, functions, recursion, and multidimensional arrays are supported. The branching constructs IF . . THEN . . ELSE and CASE . . OF as well as the looping constructs REPEAT . . UNTIL and WHILE . . DO are also supported. Data types that are supported are BOOLEAN, CHAR, ALFA (six-character string), INTEGER, and BYTE as well as scalars which can be made members of sets.

The standard input/output (I/O) procedures (RESET, REWRITE, READLN, WRITELN, READ, WRITE) are defined, as are the standard ordinal and predicate functions ORD, CHR, SUCC, PRED, ODD, EOF and EOLN. Additionally, the procedures HALT and POKE are defined as are the functions PEEK and USER.

The compiler generates pseudocode (p-code) that is in-

terpreted by the run-time system. The run-time system simulates the Pascal P-machine. For those unfamiliar with Pascal, this is a standard approach. The P-machine is a theoretical, stack-oriented machine designed specifically for execution of Pascal. This makes it possible to transport the compiler to another machine by writing a p-code interpreter for the new machine.

The Lucidata run-time system allows automatic paging of the p-code file. In other words, if all of the p-code for your program does not fit in available memory, the run-time system reads it in pieces from a disk as required. Because of this feature, it is possible to run the compiler in 12 K bytes (plus 4 K or 8 K for mini-FLEX or FLEX).

The manual describes this particular subset of Pascal in detail, then discusses the run-time system. This includes a description of how to use files. The memory requirements are discussed next. This includes how to estimate memory required for p-code, stack, and file buffers, and for the run-time system. The estimation of disk storage requirements is also discussed. The final chapters cover fine tuning of your programs and the run-time system. The customizing of the run-time system includes interfacing your program to assembly language subroutines and support of non-FLEX-compatible peripheral devices.

Five appendices are included. The first is the syntax diagrams for P-6800 Pascal. Next is a list of compiler error messages. Then there is a list of run-time error messages. The fourth appendix consists of sample programs that demonstrate most of the system capabilities. These sample programs are also on the system disk so you can play with them. The last appendix is a bibliography of further reading on Pascal.

What you receive is a P-6800 Pascal compiler and run-time package, a good manual, sample programs, and excellent delivery. If you are running FLEX 2.0 or mini-FLEX, the Pascal system can be installed in a few minutes. The P-6800 package costs \$150.00 from Lucidata, Oosteinde 223, 2271 EG Voorburg, Netherlands. Their telephone number in the Netherlands is 70-862387. ■

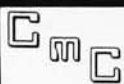

TRS-80 ANALOG INPUT

Analog to Digital Conversion System for the TRS-80 Computer



Give your TRS-80 computer the ability to measure and control the world around it with uMAC SYSTEMS modules. Just plug the TRS-80 SET1 into your keyboard or expansion interface to get 16 channels of analog input. Screw terminals are provided for each channel so you can hook up pots, joysticks, thermometers, light probes, or whatever appropriate sensors you have.

Each of the 16 analog inputs, in the range of 0 to 5.12 volts, is converted to a number between 0 and 255 (20 millivolts per count). Software is included.

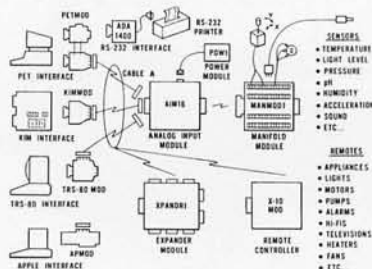

- TRS-80 SET1
- 16 ANALOG INPUTS - 8 BITS - 100 MICROSEC
- 1-AIM16
 - 1-TRS-BOMOD
 - 1-CABLE A24
 - 1-MANMOD1
 - 1-POW1

TRS-80 SET1a for 110 VAC \$ 295
TRS-80 SET1e for 230 VAC \$ 305

Order direct or contact your local computer store.

CONNECTICUT microCOMPUTER, Inc.
150 POGONO ROAD
BROOKFIELD, CONNECTICUT 06804
TEL: (203) 775-9659 TWX: 710-456-0052

VISA AND M/C ACCEPTED - SEND ACCOUNT NUMBER, EXPIRATION DATE AND SIGN ORDER.
ADD \$3 PER ORDER FOR SHIPPING & HANDLING - FOREIGN ORDERS ADD 10% FOR AIR POSTAGE.

Order the professional's choice.

UCSD Pascal.™

The Pascal everyone is talking about is UCSD Pascal... with over 10,000 users and growing. The fully developed Pascal is available with support from a professional software company. Implemented on most major microprocessors.

Not just another compiler, but complete development software — from operating system to screen-oriented editor. Language extensions for systems development and commercial applications programming.

Program portability that allows programs written on one microcomputer to run without recompilation on different microcomputers. This protects your software investment... without restricting your hardware options.

If you have CP/M®, visit your local computer store or order below. System supplied on single-density, soft-sectored, 8" floppy disks and requires 48K of contiguous RAM. For other systems call us or write for more information. Telephone orders accepted with Master Charge or VISA.

SOFTech
MICROSYSTEMS
 A SUBSIDIARY OF SOFTECH

9494 Black Mountain Road • San Diego • CA • 92126
 TEL: (714) 578-6105 • TWX: 910-335-1594

CP/M is a registered trademark of Digital Research Corporation. LSI-11 is a trademark of Digital Equipment Corporation. UCSD Pascal is a trademark of the Regents of the University of California.

- Yes! Rush me a complete UCSD Pascal system for my CP/M® based microcomputer. A check or money order for \$300.00 is enclosed. I have a _____ computer.
- Send me more information about UCSD Pascal. Versions are available for systems using the following microprocessors: LSI-11,™ 6502, 6800, 6809, 9900, Z80 and 8080/8085.
- Send me only the complete set of documentation for UCSD Pascal. A check or money order for \$37.00 is enclosed.
- Send distributor information.

Name _____

Company _____

Address _____

City _____

State/Zip _____

M/C or VISA # _____ Exp. Date _____

Mass. and Calif. residents enclose applicable sales tax.

B-3

WE CARRY —

- CROMEMCO
- NORTH STAR
- VECTOR GRAPHICS
- THINKER TOYS
 - NEC
- CENTRONICS
- INTERTUBE — \$750.00
 - SERENDIPITY
- SOROC — \$775.00
- TEXAS INSTRUMENTS

Professional A/R, A/P, Ledger, Payroll, Medical Billing software with customization available. Send for our catalog — Send for quote.

Call for quote.

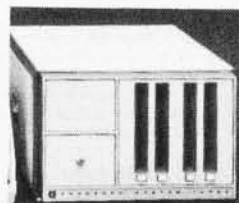

**SARA-TECH
 COMPUTERS**

P.O. Box 692

Venice, FL

33595

(813) 485-3559



APPLE • CENTRONICS • TEXAS INSTRUMENTS
 HORIZON • VECTOR GRAPHIC • CROMEMCO
 • RADIO SHACK • HP • MICROPOLIS • SOROC
 • OSI • SWTP • M • IBM • NEC •
 PET • DIABLO • HAZELTINE
 • HEATH • D • IMSAI •
 DEC • PET • • SOL
 • WANG • • LSI •



WE'VE GOT YOU COVERED!

Cover Craft Dust Covers protect your hardware and your investment. Save maintenance, downtime and look great. Our Dust Covers come in hundreds of sizes each custom designed to fit a particular model of terminal, CPU, Line Printer, Floppy Disk. They're a proven way to help eliminate dust and dirt accumulation, improve system reliability and save many times the cost in reduced maintenance and downtime. What's more, your satisfaction is 100% guaranteed.

Cover Craft Dust Covers are available from your local computer retailer or contact Cover Craft. **\$6.95 - \$9.95**

Can you afford to wait any longer?

COVER CRAFT

P.O. Box 555, Amherst, NH 03031
 Telephone (603)889-6811

DYNACOMP

Quality software for: Apple II Plus
TRS-80 (Level II)
North Star

All software is supplied with complete documentation which includes clear explanations and examples. Each program will run with standard terminals (32 characters or wider) and within 16K program memory space. Except where noted, all software is available on North Star diskette (North Star BASIC), TRS-80 cassette (Level II) and Apple cassette (Applesoft BASIC). These programs are also available on PAPER TAPE (Microsoft BASIC).

FLIGHT SIMULATOR

Price: \$17.95 postpaid

(as described in SIMULATION, Volume II)

A realistic and extensive three-dimensional simulation of take-off, flight and landing. The program utilizes aerodynamic equations and the characteristics of a real airfoil. You can practice instrument approaches and navigation using radials and compass headings. The more advanced flyer can also perform loops, half-rolls and similar aerobatic maneuvers.

SIMULATION, Volume II (BYTE Publications): \$6.00

VALDEZ

Price: \$14.95 postpaid

A simulation of supertanker navigation in the Prince William Sound and Valdez Narrows. The program uses an extensive 256X256 element radar map and employs physical models of ship response and tidal patterns. Chart your own course through ship and iceberg traffic. Any standard terminal may be used for display.

BRIDGE 2.0

Price: \$17.95 postpaid

An all-inclusive version of this most popular of card games. This program both BIDS and PLAYS either contract or duplicate bridge. Depending on the contract, your computer opponents will either play the offense OR defense. If you bid too high the computer will double your contract! BRIDGE 2.0 provides challenging entertainment for advanced players and is an excellent learning tool for the bridge novice.

HEARTS 1.5

Price: \$14.95 postpaid

An exciting and entertaining computer version of this popular card game. Hearts is a trick-oriented game in which the purpose is not to take any hearts or the queen of spades. Play against two computer opponents who are armed with hard-to-beat playing strategies.

DATA SMOOTHER

Price: \$14.95 postpaid

This special data smoothing program may be used to rapidly derive useful information from noisy business and engineering data which are equally spaced. The software features choice in degree and range of fit, as well as smoothed first and second derivative calculation. Also included is automatic plotting of the input data and smoothed results.

FOURIER ANALYZER

Price: \$14.95 postpaid

Use this program to examine the frequency spectra of limited duration signals sampled at equal intervals. The program features automatic scaling and plotting of the input data and results. Practical applications include the analysis of complicated patterns in such fields as electronics, communications and business.

MAIL LIST I

Price: \$18.95 postpaid (available for North Star only)

A many-featured mailing list program which sorts through your customer list by user-defined product code, customer name or Zip Code. Entries to the list can be conveniently added or deleted and the printout format allows the use of standard size address labels. Each diskette can hold approximately 900 entries.

MAIL LIST SERVICE

DYNACOMP can provide you with a customized mail list service. Your customer/patient records are placed in a master computer file and you are provided with addressed, self-adhesive labels for your mailings. These labels may be sorted by name, Zip Code, date, or other identifiers. Write for further details and a price schedule.

TEXT EDITOR I (Letter Writer)

Price: \$14.95 postpaid

An easy to use, line-oriented text editor which provides variable line widths and simple paragraph indexing. This text editor is ideally suited for composing letters and is quite capable of handling much larger jobs.

GAMES PACK I

Price: \$10.95 postpaid

Seven entertaining games for less than a dollar a kilobyte! Play CATAPULT, CRAPS, SWITCH, HORSERACE, SLOT MACHINE, BLACKJACK and LUNAR LANDER. This is an excellent way to introduce your children to computers.

All orders are processed within 48 hours. Please enclose payment with order. If paying by MASTER CHARGE or VISA, include all numbers on card. Foreign orders add 10% for shipping and handling.

Write for detailed descriptions of these and other programs available from DYNACOMP.

DYNACOMP

P.O. Box 162

Webster, New York, 14580

New York State residents please add 7% NYS sales tax.



Technical Forum

The Direct Impact of the Computer

Richard S Shuford, Editor

Some years ago, I was doing volunteer work for a non-profit organization. Late one evening we were preparing an important newsletter for mailing the next day. We had used a computer at Lenoir-Rhyne College, where I was a student, to prepare our adhesive address labels. We had pasted on all the labels when we found that our rubber stamp that said "ADDRESS CORRECTION REQUESTED" had been lost.

Groaning over our misfortune, we were just about to begin the time-consuming task of writing this message on every envelope by hand, when I had the following thought: the computer printed the address labels for us; why can't it print *this* simple message?

I began to consider how the job could be handled using the computer facilities available. Adhesive labels were too expensive to print the message on and then affix to the envelopes. But wait, perhaps we do not have to use the labels. Could the computer printer print directly on the envelopes?

A time-honored principle is that if there is a simple test to be made, make it. So I gathered up several newsletter envelopes and hastened to the college's academic computer center to try it.

The particular printing peripheral I had in mind was a Centronics Model 101A, high-speed, serial character impact printer, which we loosely called a "line printer." This Centronics machine prints dot-matrix characters by driving a column of print pins into an inked ribbon held before the paper as the print head moves horizontally. (Many other printers also work in this manner.) The Centronics printer has a paper-thickness adjustment, which soon became important.

The Centronics printer was attached to a minicomputer timesharing system. I logged into the system, and quickly wrote a BASIC program. After a brief period of experimentation, I saved my program, logged out, and dashed back to the other late-night envelope-stuffers to report success.

I led a disbelieving troop of workers carrying stacks of envelopes back to the computer room to see how I was going to save them a lot of work by letting the machine do some. My demonstration worked like this.

I logged in and called up the BASIC program I had written for my experiment. This program is shown in listing 1. I typed "RUN" on my terminal, and with one hand held a newsletter envelope carefully inside the print position of the Centronics printer, just behind the ribbon. As the others crowded around to see what I was doing, I hit the carriage return key on the terminal with my free

hand. The print head buzzed and moved across the envelope. I held up the letter, and all could see that "ADDRESS CORRECTION REQUESTED" was plainly printed on it in dot-matrix characters.

Well, we set up an assembly line to insert envelopes into the printer and then to stack them. We found that using the computer printer actually was faster than using the rubber stamp, but I do not recommend buying a computer if you can get by using a rubber stamp under normal conditions. The computer did allow us to get our mailing out on time. (Later on, of course, it was not so much fun to pay \$0.25 for every corrected address that came back, but we got our mailing list updated).

If you want to try to use this rubber-stamp simulator, observe these points. The print head can move very fast, and you *can* hurt yourself if you are not careful as you hold the paper inside the printer. You have to be sure to hold the paper in the right place. With the Centronics, the right place is approximately 5 cm (2 inches) to the right of the print head's rest position, behind the ink ribbon. Timing is not critical with this program. Note that the program requires that you press the return key before it will print anything. There is no rush to insert the paper into the printer, since you just hit the key when you are ready.

Finally, note that the paper-thickness adjustment is fairly critical for printing on an envelope that has a newsletter in it. Adjust carefully, so that the print head neither shreds the envelope, nor fails to print, nor jams and becomes damaged.

The moral of this story is not that rubber stamps are obsolete. Rather this: a general-purpose computer system is *exactly* that—general purpose. If you buy a computer to assist you in keeping up with your tax records or the like, that is fine. But don't forget that the *program* determines the function of the computer. The next time you have a problem, whether simple or complex, perhaps the computer can help you with it.

Listing 1: A BASIC program that uses a computer equipped with an impact printer to simulate a rubber stamp in printing a simple message many times.

Line 10 determines what message is printed. Lines 20, 30, and 40 print the message on the terminal for verification. Line 50 is used to give the human operator time to put the paper inside the printer in the correct position. The computer will not output the message to the printer until the operator presses the return key in response to the INPUT statement in line 50. Variable B\$ is merely a dummy variable.

The LPRINT statement in this version of BASIC causes output to the line printer. The TAB(10) function causes 10 spaces to be printed before the message. Line 70 causes the program to loop indefinitely. Execution must be terminated by some means provided by the system. Such a means could be typing control-C, pressing a Break key, or hitting a Reset switch.

```

5 REM RUBBER STAMP SIMULATOR
6 REM USE WITH COMPUTER IMPACT PRINTER
10 A$ = "ADDRESS CORRECTION REQUESTED"
20 PRINT "HIT 'RETURN' KEY TO PRINT"
30 PRINT A$
40 PRINT "WITH PRINTER."
50 INPUT B$
60 LPRINT TAB(10); A$
70 GOTO 50
99 END ■

```

SAVE ON ADD-ON PRODUCTS FOR TRS-80

The largest family of disk drives from the largest supplier, drives come complete with power supply and cabinet.

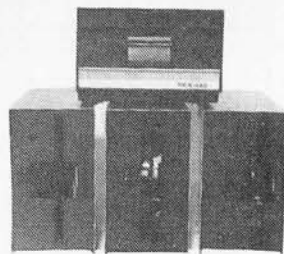

TF-Perfec FD200, 40 track, use both sides	\$382
TF-3 Shugart SA400, 35 track, same as tandy	\$389
TF-5 MPI B51, 40 track	\$379
TF-70 Micropolis, 77 track with 195K of storage	\$639
TDH-1 Dual sided drive, 35 track	\$499

* MAXI DISK *

Maxi Disk 1: 10 Megabyte Hard Disk with 5 fixed, 5 removable with controller	\$6299
Maxi Disk 2: 10 Megabyte (fixed) Winchester Technology	\$5349
77 tracks of Storage includes new DOS+	\$695

PRINTERS

DP800 Anadex, 80 column, 112cps	\$950
LP779 Centronics 779	\$1099
LP730 Centronics 730	\$950
LP700 Centronics 700-1	\$1495
LP701 Centronics 701-1	\$1759
LP702 Centronics 702-2	\$1995
SPW-1 Spinwriter-NEC	\$2495

NEW! LINE PRINTER BASE 2

Base 2 Printer 80, 132 col., graphics 60 LPM with tractors. **\$599**

* DRIVES FOR ANY MICROCOMPUTER *

Does not include power supply & cabinet.

MOD II DISK DRIVES NOW AVAILABLE

Perfec FD200	\$282
Perfec FD250 (dual head)	\$399
Shugart SA400 (unused)	\$286
Shugart SA800	\$479
MPI B51	\$279
MPI B52	\$349

SOFTWARE

New DOS+ with over 200 modifications and corrections to TRS-DOS	\$99
New DOS+ 40 track	\$110
AJA Word Processor	\$75
AJA Business Program	\$250
Racet Infinite Basic	\$49.95
Disk Drive Alignment Program	\$109
Radix Data Base Program	\$99.95
Electric Pencil	\$150

ALL PRICES CASH DISCOUNTED. FREIGHT FOB/FACTORY



3304 W. MacArthur
Santa Ana, CA 92704
(714) 979-9923



7310 E. Princeton Ave.
Denver, CO 80222
(303) 758-7275

Circle 124 on inquiry card.

Circle 125 on inquiry card.

TERMINALS

FROM TRANSNET

PURCHASE FULL OWNERSHIP AND LEASE PLANS

DESCRIPTION	PURCHASE PRICE	PER MONTH		
		12 MOS.	24 MOS.	36 MOS.
LA36 DECwriter II	\$1,695	\$162	\$ 90	\$ 61
LA34 DECwriter IV	1,295	124	69	47
LA120 DECwriter III KSR	2,295	220	122	83
VT100 CRT DECscope	1,895	182	101	68
VT132 CRT DECscope	2,295	220	122	83
DT80/1 DATAMEDIA CRT	1,895	182	101	68
TI745 Portable Terminal	1,595	153	85	57
TI765 Bubble Memory Terminal	2,795	268	149	101
TI810 RO Printer	1,895	182	101	68
TI820 KSR Printer	2,195	210	117	79
TI825 KSR Printer	1,695	162	90	61
ADM3A CRT Terminal	875	84	47	32
QUME Letter Quality KSR ...	3,195	306	170	115
QUME Letter Quality RO	2,795	268	149	101
HAZELTINE 1410 CRT	875	84	47	32
HAZELTINE 1500 CRT	1,195	115	64	43
HAZELTINE 1552 CRT	1,295	124	69	47
DataProducts 2230 Printer ..	7,900	757	421	284
DATAMATE Mini Floppy	1,750	168	93	63

FULL OWNERSHIP AFTER 12 OR 24 MONTHS
10% PURCHASE OPTION AFTER 36 MONTHS

ACCESSORIES AND PERIPHERAL EQUIPMENT

ACOUSTIC COUPLERS • MODEMS • THERMAL PAPER RIBBONS • INTERFACE MODULES • FLOPPY DISK UNITS
PROMPT DELIVERY • EFFICIENT SERVICE



TRANSNET CORPORATION

1945 ROUTE 22, UNION, N.J. 07083

201-688-7800

TWX 710-985-5485

NO FRILLS! NO GIMMICKS! JUST GREAT

DISCOUNTS MAIL ORDER ONLY

HAZELTINE

1400
1410
1420
1500
1500(Kit)

Call For Prices

CENTRONICS

779-2 995.00
700-2 1350.00
703 tractor 2195.00
Micro Printer 395.00
730 975.00

NORTHSTAR

Horizon I assembled .. 1629.00
kit 1339.00
Horizon II assembled .. 1999.00
kit 1599.00

TELETYPE

Mod 43 995.00

INTERTEC

Superbrain 2495.00

DIGITAL SYSTEMS

Computer \$4345.00
Double Density
Dual Drive 2433.00

TELEVIDEO

912
920
Call For Prices

DEC

LA 34 1149.00

CROMEMCO

System III \$1000 off .. 4990.00

TEXAS INSTRUMENTS

810 Printer 1595.00

ATARI 800

..... 795.00

ADDS Regent 25

..... CALL

Optima Cabinets (New)

..... 99.95

5" Scotch Diskette

..... Box/29.95

8" Scotch Diskette

..... Box/34.95

Most items in stock for immediate delivery. Factory-fresh, sealed cartons.

DATA DISCOUNT CENTER

Box 100 135-53 Northern Blvd., Flushing, New York 11354, 212/465-6609

N.Y.S. residents add appropriate Sales Tax. Shipping FOB N.Y.
BankAmericard, Master Charge add 3%. COD orders require 25% deposit.

Technical Forum

Cutting the Gregorian Knot

Myron Pulier MD, 101 Cedar Ln, Teaneck NJ 07666

Program development is more an artistic process of playful reshaping than it is an analytic process of systematic logic. This proved true in a search for an efficient way of handling dates in computer programs.

Using dates in Julian day-number form simplifies manipulation of date information. For example, if the Julian date of the calendar date January 1 is 1, then February 2 would be 33 and December 31 would be 365, or 366 on leap year. Clearly it is easier to store a single number than to wrestle with a number triplet like 9/8/79. Furthermore, the Julian concept makes finding the number of days between two dates a trivial process.

Calculation of the Julian date is complicated because Roman legislators altered Julius Caesar's orderly scheme by making the months uneven in length. This inspired Richard Grafton's famous table lookup. In the year 1570 he wrote "Thirty days hath November, April, June, and September," etc. While there's no longer much danger of copyright infringement, Grafton's method wastes memory space, rest his soul.

According to Grafton the months with thirty days are the eleventh, fourth, sixth and ninth, which seems difficult to convert into a formula. If only Grafton and his politician forebears had given the second month thirty days as well! We would then be close to the familiar sequence 2,4,6,8,10, which can be calculated by the formula $B = 2 \times A$. If we plot the numbers 2, 4, 6, 9, 11 as the first, second, third, fourth, and fifth numbers of a set (as shown in figure 1), all we need is a formula that threads a line slightly above the desired values for B. We can then throw away the fractional parts by truncating the resulting B value to an integer. In other words, we want a formula of the form:

$$B = \text{INT} (C1 \times A + C2) \quad (1)$$

The determination of suitable values for the constants C1 and C2 may not be immediately obvious. An empirical method for finding C1 and C2 is trial-and-error substitution using the following BASIC program:

```

110 INPUT C1, C2
120 FOR A = 0 TO 13
130 LET B = C1 * A + C2
140 PRINT A, INT ( B ), B
150 NEXT A
160 GOTO 110
    
```

I suggest you enter the above program on your own computer and try values for C1 and C2.

What you 'C' is what you get!

C Compiler for CP/M*

New, and available now! An easily affordable compiler incorporating most of the features of the full C language.

BD SOFTWARE

System requirements: CP/M and at least 24K of RAM

Variable Types: char, int, unsigned

Composite Types: arrays, structures, unions

Pointers: to variables, structures, unions and functions

Features: is a structured language, all functions (Programs) recursive; more powerful expression operators than any other von Neumann type language; allows free-formatted source; close enough to UNIX** C to make conversions feasible.

Speed: On 2 MHz 8080, the statement for (i = 1; i < 30000; i++) x = 5; takes about 4 seconds to execute.

Package contains: compiler, linker, library manager; standard function library; sample source files include games, a terminal emulator with disk I/O plus the source for many standard library functions; BDS C User's Guide; Book—*The C Programming Language* by Dennis Ritchie and Brian Kernighan of Bell Labs. **Price: \$125**

Recipient of the Computer Lib Seal of Approval

*CP/M is a trademark of Digital Research Corp.

**UNIX is a trademark of Bell Laboratories

Prices reflect distribution on 8" single density diskettes. If a format is requested which requires additional diskettes a surcharge of \$5. per additional diskette will be added.

Lifeboat Associates

2248 Broadway, New York, N.Y. 10024 (212) 580-0082 Telex: 220501

CP-80 COMPUTER CLOCK/CALENDAR



**A Real Time Saving Device
For Only \$149.95 + Shipping Charge**

CP-80 FEATURES:

Exact time and date on all computer printouts • Time and date not affected by computer shutdown • Time and date set by software • Functions as an elapsed timer • Compatible with all standard parallel ports • Will maintain time and date on 115V AC or optional standby power

SPECIFICATIONS:

Attractive two tone blue and white cabinet • 5¼ x 2 x 8 in. • 4 year calendar • Optional standby power • Requires one input and output parallel port TTL compatible and 115 VAC • 12 or 24 hour format • 50 or 60 HZ operation • All software and diagrams included

TERMS:

CHECK WITH ORDER • C.O.D. • VISA • MASTER CHARGE

CP Products

1427 Agnes Street
Kansas City, Mo. 64127
816-483-1000

BATTERY-WRAP WIRE WRAPPING TOOL MODEL BW-2630

- POSITIVE INDEXING
- ANTI-OVERWRAPPING
- BITS AVAILABLE FOR AWG 26, 28 & 30
- BATTERY OPERATED
- LIGHT WEIGHT

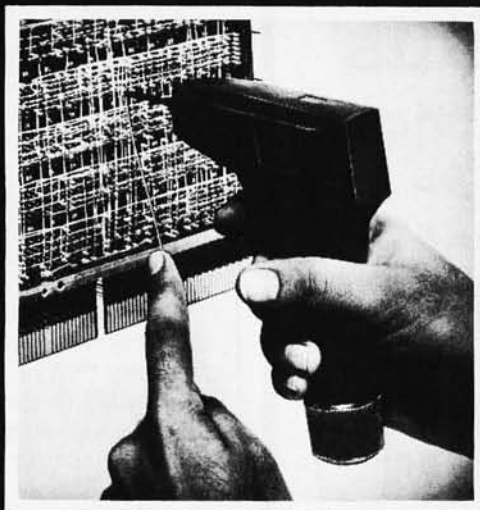

\$19⁸⁵*

**BATTERIES AND
BIT NOT INCLUDED**

U.S.A.
FOREIGN
PATENTS
PENDING



BW-2630	BATTERY-WRAP TOOL	\$19.85
BT-30	BIT FOR AWG 30	\$ 3.95
BT-2628	BIT FOR AWG 26 & 28	\$ 7.95
RB-20	TWO NI-CAD BATTERIES	\$10.75

OK MACHINE & TOOL CORPORATION

3455 CONNER STREET, BRONX, N.Y. 10475, U.S.A.

PHONE (212) 994-6600 • TELEX: 125091

*MINIMUM BILLING \$25.00 / ADD SHIPPING CHARGE \$2.00 / NEW YORK CITY / STATE RESIDENTS ADD APPLICABLE TAX.

Radio Shack[®] DEALER
COMPUTER SPECIALISTS



**15% Discount
 on
 TRS-80's - I
 AND ACCESSORIES**

FAST 100 cps Centronics 730 PRINTER . . \$800.00
 HIGHLY RELIABLE LOBO DRIVES . . . \$375.00

MICRO MANAGEMENT SYSTEMS
 DOWNTOWN PLAZA SHOPPING CENTER
 115 C SECOND AVE. S.W.
 CAIRO, GEORGIA 31728
 912-377-7120

**DEC LSI-11
 Components**

**Dependable service
 at discount prices**

**Domestic
 and Export**

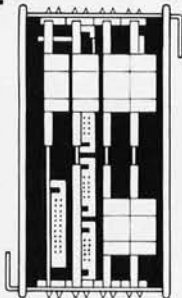

**Mini
 Computer Suppliers, Inc.**

25 Chatham Rd., Summit, N.J. 07901
 Since 1973

(201) 277-6150 Telex 13-6476

©Mini Computer Suppliers, Inc.
 1979

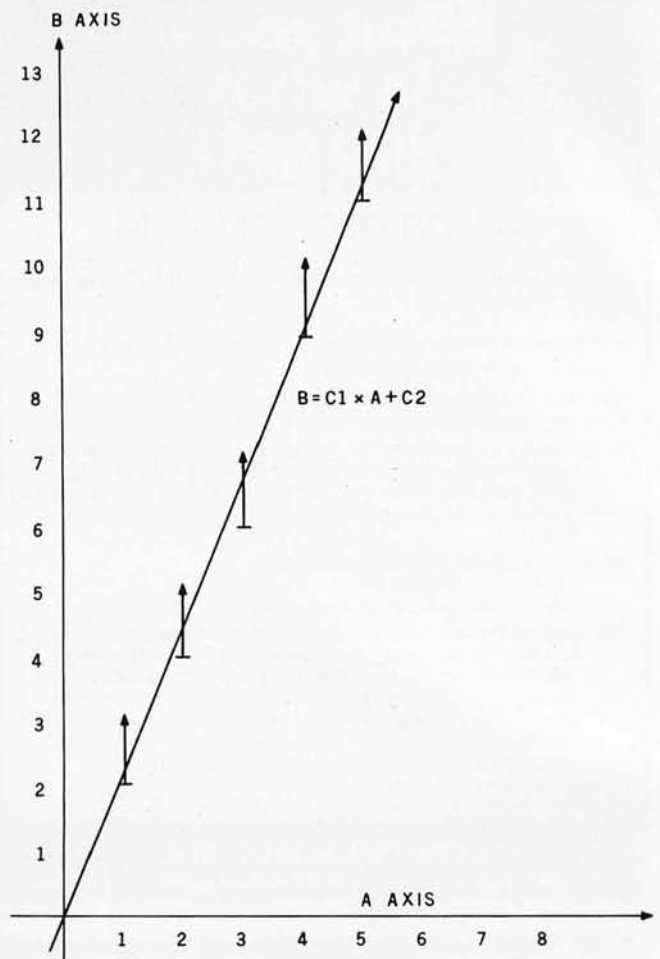

Figure 1: Fitting the numbers 2, 4, 6, 9, 11 to the straight-line equation $B = C1 \times A + C2$. Given the sequence 2, 4, 6, 9, 11, we can represent this in two dimensions by letting the horizontal axis represent the order of the number in the sequence (first, second, etc), and the vertical axis, the value of the number (2, 4, etc). Thus, the fourth number in the sequence, 9, gives the point (4,9) to be plotted. These numbers are almost, but not quite, on a straight line. But if we stipulate that the line can go through the unit line segments extending above each point, then the integer values can be obtained by truncating the values obtained with the INT function in BASIC.

Playing around with this program shows that C1 can range between 2 and 2.5 if C2 is suitably chosen between -0.5 and 1. For example, setting C1 to 2.25 and C2 to 0 gives the desired sequence of 2,4,6,9,11, . . . for INT(B).

Now we can turn our attention to the irregularities in the Gregorian calendar. First, let us temporarily give February thirty days (remember that month 2, February, is included in the above sequence). Next, calculate the Julian values of the last days of each month in this altered year. The numbers are 31, 61, 92, 122, 153, 183, 214, 245, 275, 306, 336, 367. (The extra two days in February give us a 367-day year). Can we find a formula that threads its way along the last days of each month?

We have 367 days divided among 12 months. That comes to a new month about every 30.58 days. If we use 30.58 for C1 in the program we wrote, we find that the output comes close to the sequence we want. A few minutes of tinkering with C2 shows that 0.5 works nicely. The expression M-1 gives us the last day of the

preceding month. Substituting the values for C1 and C2, and using (M-1) in place of A in equation (1) produces the equation:

$$B = \text{INT} (30.58 \times M - 30.08) \quad (2)$$

A quick check with our BASIC program shows that we can get away with three bytes less with the following equation:

$$B = \text{INT} (30.57 \times M - 30) \quad (3)$$

If we compensate for leap years and for the 28-day February, we have the following BASIC subroutine for computing the Julian date, Z, given the month, M, day, D, and year, Y.

```

210 Z = INT ( 30.57 * M - 30 ) + D
220 IF M < 3 THEN RETURN
230 IF INT ( Y / 4 ) * 4 = Y
    THEN Z = Z - 1 : RETURN
240 Z = Z - 2 : RETURN

```

Using the constant values we found for equation (3), line 210 calculates the Julian date of the end of the month preceding month M. Adding the day of the month to this produces a first estimate of the Julian date of the given calendar date. Line 220 says that if it is before March, we are done. Otherwise, in line 230 we adjust for a 29-day February if it is leap year (until now we were crediting February with 30 days), or for 28 days if it is not leap year. Let us forget about leap centuries for now.

We can improve on this system. We have been defining the Julian date, Z, as the number of days since the previous December 31. To include information about the year, we can define a new type of Julian date, J, as the number of days elapsed since December 31 of some base year, say 1972. To calculate J, we first find Z, then add the days in each year between the present year and 1972. Years have an average of 365.25 days. If we try 365.25 for C1 and 0 for C2 in our original BASIC program tool, we get the Julian dates of the last day of each year. Taking December 31, 1972 as our base and the year, Y, in the form "yy" rather than "19yy" we modify equation (3) to:

$$B = \text{INT} (30.57 \times M - 30) + \text{INT} (365.25 \times (Y - 1 - 72)) \quad (4)$$

This may be rearranged to:

$$B = \text{INT} (30.57 \times M) + \text{INT} (365.25 \times Y - 26693.25) \quad (5)$$

bringing us to the new BASIC subroutine:

```

310 J = INT ( 30.57 * M ) + INT ( 365.25
    * Y - 26693.25 ) + D
320 IF M < 3 THEN RETURN
330 IF INT ( Y / 4 ) * 4 = Y
    THEN J = J - 1 : RETURN
340 J = J - 2 : RETURN

```

The above will return negative values for dates before December 31, 1972.

CONTROL THE WORLD THROUGH A EIA RS-232C PORT

NEW NEW

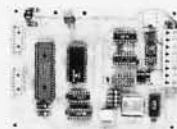

ALI has designed a new control system that uses a standard serial port to communicate to over 1000 output points and read over 1000 input points. With this system you can now control relays, lights, motors, D/A, and sense photo eyes, voltage, switches, A/D, keyboards and a lot more. All this control over a single RS-232C link! All it takes is a standard RS-232C port and one or more ALI control modules, per your I/O requirement. Up to 225 modules can be connected to a single EIA RS-232C port.

The modules consist of an I/O CONTROL COMMANDER by itself or in conjunction with one of the specific I/O interface boards. Each I/O CONTROL COMMANDER has 8 TTL inputs and 4 TTL outputs, plus all of the circuitry necessary for proper address decoding and communications timing. Each CONTROL COMMANDER is crystal controlled for highest accuracy and reliability. Baud rate is selectable from 150 to 9600 baud.

Various peripherals can be plugged into the I/O CONTROL COMMANDER to handle specific I/O functions.

	ASSM	KIT
I/O CONTROL COMMANDER	\$149	\$129
• 8 TTL inputs		
• 4 TTL outputs		
• 150 to 9600 Baud		
• Crystal controlled		
RELAY INTERFACE	120	98
• 4 2A, 120V AC relay outputs		
• 4 5V-120V AC or DC opto-isolated inputs		
UNIVERSAL I/O, KEYBOARD DISPLAY INTERFACE	190	152
• Up to 16 character display		
• Up to 32 digits display		
• Up to 64 individual inputs		
• Sense full ASCII keyboard		
• Up to 128 individual outputs		
ALPHA NUMERIC DISPLAY	179	155
• 16 Alpha numeric displays		
• Mates with UVKD		
THUMBWHEEL SWITCH UNIT	165	145
• 8 Digits BCD inputs		
• 32 Bits TTL input		
• Mates with UVKD		

As you can see from the above description, you can mix and match modules to meet your specific requirements. All this and more over a single RS-232C link. The above is only a brief summary of the available options.

TO ORDER CALL OR WRITE:

AL INDUSTRIES
15 Algonquin Trail, Oakland, N.J. 07436
(201) 337-2030



*N.J. Residents add 5% sales tax • Dealers Inquiries Invited



MICRO AID®

THE TEACHER'S HELPER

MICRO AID® is an educational computer package designed to free the teacher from much of the drudgery inherent in testing, tracking, and grading students.

FEATURING: ■ Quiz with instruction mode ■ Computer aided instruction with quiz mode ■ Multi student participation ■ Recording of student grades ■ 3 levels of subject knowledge for individualized testing scores ■ Inventory build-up of test questions ■ Analysis of answers per student and entire class ■ Randomized questions rarely duplicating a quiz ■ Hard copy printed questions for major testing.

NO TECHNICAL EXPERIENCE NEEDED: Teacher simply types in questions, answers, and explanations. MICRO AID® is designed as a plug-in, easy to use system with no technical background required.

TEACHER IN FULL COMMAND: MICRO AID® is "menu-driven" in that it allows the teacher to select individualized teaching functions, perform an activity within a function, choose the number of questions to be on a quiz and sign on each student as he/she sits at the terminal.

INEXPENSIVE & COST EFFECTIVE: MICRO AID® system — \$9,900, includes 4 CRT keyboard terminals, CPU & printer, software, and instruction manuals. Software only, \$750. Instruction manual only, \$40. Write or call for detailed information.



MICRO INNOVATIONS CORP.

420 LEXINGTON AVE., NY 10017

(212) 687-3637

DEALER INQUIRIES INVITED

TRS-80 LEVEL II

\$750. COMPLETE SYSTEM

The world's most popular microcomputer, with 16K of memory and Level 11 basic for only \$750, complete with full 90 day Radio Shack warranty. We accept check, money order or phone orders with Visa or Master Charge. (Shipping costs added to charge orders).

Disk drives, printers, peripherals, software and games . . . you name it, we've got it (Both Radio Shack & other brands). Write or call for our complete price list.



Shown is Level I. Level II includes Alphanumeric keypad.

C&S ELECTRONICS MART Ltd.

AUTHORIZED DEALERSHIP

Radio Shack

32 E. Main Street • Milan Michigan 48160 • (313) 439-1400

AG REMOTE CONTROL
FROM YOUR COMPUTER

TRS-80 PET S100 APPLE KIM AIM65

INEXPENSIVE CONTROL SOLUTION FOR

HOME SECURITY • ENERGY CONSERVATION
GREENHOUSES • ENVIRONMENTAL CONTROL
INDUSTRIAL CONTROL • LABORATORIES

WITH CLOCK AND CALENDAR

CmC's μ DAC system now includes an interface to the BSR X-10 remote control modules. These low-cost modules allow control over lamps, motors and appliances. With the CmC X-10 interface your computer can control 256 separate devices. Lamps can be turned on or off, dimmed or brightened. Alarms, kitchen appliances, hi-fis, TVs, motors, pumps, heaters and more can be put under your computer's control.

Direct plug-in and software for most computers.

Includes a clock, calendar, digital inputs and digital outputs.

Circle the reader service number, call or write for our latest catalog.



CONNECTICUT microCOMPUTER, Inc.
150 POCOMO ROAD
BROOKFIELD, CONNECTICUT 06804
TEL: (203) 775-9659 TWX: 710-456-0052

Listing 1: BASIC routines for converting between the Julian date and the calendar (month, day, year) date and for determining the day of the week from the Julian date. In Processor Technology BASIC, the multiple-line user-defined functions (ending with FNEND) are permitted; also, J\$(A,B) is the substring of the unsubscripted string variable "J\$", from Ath to Bth character.

```

700 REM=====
710 REM
720 REM.          DATE HANDLING PACKAGE
730 REM
740 REM=====
750 REM-----
760 REM.    CALENDAR TO JULIAN CONVERSION
770 REM
780 REM.Given day, D, month, M and year, Y
790 REM.returns the number of days elapsed
800 REM.since December 31, 1900.
810 REM-----
820 DEF FNJ(D,M,Y)
830 LET X=INT(30.57*M)+INT(365.25*Y-395.25)+D
840 IF M<3 THEN RETURN X
850 IF INT(Y/4)*4=Y THEN RETURN X-1
860 RETURN X-2
870 FNEND
880 REM
890 REM-----
900 REM.    JULIAN TO CALENDAR CONVERSION
910 REM
920 REM.Given D, number of days elapsed since
930 REM.December 31, 1900, returns day, D,
940 REM.month, M, and year, Y.
950 REM-----
960 LET Y=INT(J/365.26)+1
970 LET D=J+INT(395.25-365.25*Y)
980 LET D1=2: IF INT(Y/4)*4=Y THEN LET D1=1
990 IF D>91-D1 THEN LET D=D+D1
1000 LET M=INT(D/30.57),D=D-INT(30.57*M): RETURN
1010 REM.
1020 REM-----
1030 REM.    JULIAN COMPACTION
1040 REM
1050 REM.Given julian, J, returns 2-byte
1060 REM.representation of J
1070 REM-----
1080 DEF FNJ$(J)
1090 LET J1=INT(J/256): RETURN CHR(J1)+CHR(J-J1*256)
1100 FNEND
1110 REM
1120 REM-----
1130 REM.    JULIAN EXPANSION
1140 REM
1150 REM.Given J$, a 2-byte representation of a
1160 REM.julian, returns decimal value of julian
1170 DEF FNJ1(J$)=256*ASC(J$(1,1))+ASC(J$(2,2))
1180 REM
1190 REM-----
1200 REM.    DAY OF WEEK CALCULATION
1210 REM
1220 REM.Returns day of week (Sunday = 1) given
1230 REM.the julian, J
1240 REM-----
1250 DEF FNW(J)
1260 LET W=(J+1)/7: RETURN INT((W-INT(W))*7+1.1)
1270 FNEND
    
```

Now that we have a way of abbreviating the calendar date into a Julian date, we need a program for reversing the conversion. This is done by extracting the year, correcting for a 28- or 29-day February, then extracting the month to leave the day of the month as the remainder:

```

410  Y = INT ( J / 365.25 + 73 )
420  Z = J + INT ( 26693.25 - 365.25 * Y )
430  D1 = 2 : IF INT ( Y / 4 ) * 4 = Y
      THEN D1 = 1
440  IF Z > 91 - D1 THEN Z = Z + D1
450  M = INT ( Z / 30.57 )
460  D = Z - INT ( 30.57 * M )
470  RETURN

```

Line 420 computes the day of the year, Z. Then D1 is set to 1 if the year is a leap year, or 2 otherwise. Z is adjusted for the proper February length in line 440, if the day is after February. The month is extracted in line 460, leaving D, the day of the month. Unfortunately, the program above is wrong for New Year's Day after a leap year because the value for Y lags a bit. This can be managed by setting the divisor in line 410 to 365.26. The resulting inaccuracy will not cause trouble for thousands of years.

You will see that selecting 1900 rather than 1972 as the base year will save two bytes each in lines 310 and 420 and one in line 410. [Note: Astronomers calculate Julian day numbers using the date January 1, 4713 BC as a base; all historical dates become positive numbers. . . .RSS]

If your version of BASIC handles character strings, it can compact each non-negative Julian date into two bytes of storage, which could speed input and output of dates by a factor of four. The following routine in Processor Technology BASIC essentially converts the decimal value of the Julian date to a base-256 number:

```

510  J1 = INT ( J / 256 )
520  J$ = CHR( J1 ) + CHR( J - J1 * 256 )

```

where CHR(J1) is the character with the ASCII code J1. Converting the string J\$ back to a decimal value is done as follows:

```

610  J = 256 * ASC ( J$ ( 1 , 1 ) ) + ASC
      ( J$ ( 2 , 2 ) )

```

where J\$(n , n) is the n-th character in J\$ and where ASC(C\$) is the decimal value of the ASCII code for C\$. The two bytes in J\$ can cover a span of $256 \times 256 / 365.25 = 179$ years.

The day of the week is readily calculated from the modulo 7 value of the Julian date. We can now reshape our programs into a compact and efficient package for handling dates between 1901 and 2080.

As for leap centuries, Pope Gregory luckily decreed the year 2000 a leap year, although 1900 was not. Century years not evenly divisible by 400 are not leap years. Therefore, the routines in listing 1 will be wrong for dates before March 1, 1900, but are useful for most practical applications. ■

PROFESSIONAL CP/M* SOFTWARE

These are superb professional quality implementations usually found on larger computers. Thorough documentation accompanies every DataArt product so you will be "up and running" immediately. In addition, all packages are delivered with CRT drivers for your terminal.

SOFTWARE PRODUCT †	CBASIC	Microsoft® COBOL	Microsoft® BASIC
● Payroll	\$250	\$500	\$350
● Accounts Receivable	250	500	350
● Accounts Payable	250	500	350
● General Ledger	250	500	350
● Bowling Secretary	350	350	350
● Program Chain Utility	95	95	95
● CRT Manager Utilities	250	250	250
● Data Communications	contact us - many protocols available		

Accounting packages based on Osborne Publications.

* CP/M is a trademark of Digital Research Corporation.

† Many software packages also available for North Star Computers.



"where software is still an art"

DataArt Inc.
 21162 Lorain Road
 Fairview Park, Ohio 44126
 (216) 333-2232

Use x,y Genesis Applesoft Subroutines for Apple II graphs

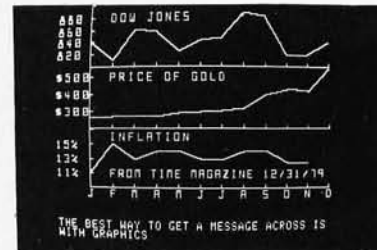

With x,y Genesis you'll have:

- smaller programs
- shorter programming time
- subroutines useful in any program
- periodic news on tips & applications
- a professional product

At only \$74.95

Contact:

FUTUREWORLD
 Dept. B2
 2514 University Dr.
 Durham, NC 27707
 (919) 489-7486

Ask about our new business statistics software.

Have some great memories.

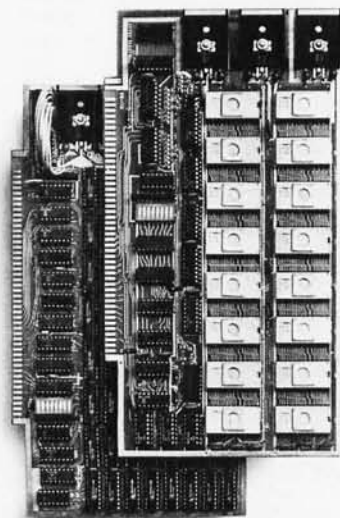

16K PROM boards.

- PROM card has 2708-type memory
- Quality board construction
- 0-4 wait states
- Address any 4K group to any 4K boundary
- Control up to 8 banks of memory
- Fully assembled and tested
- PRICE—\$300

(California residents add 6% sales tax)

Expandable 5 MHz RAM boards.

- 8—32K expandable RAM board uses TI 4044 memory
- Runs at 5MHz
- Fast 250ns access time
- Bank select
- Address any 4K block to any 4K boundary
- Quality board construction

PRICE—8K—\$210; 16K—\$378; 24K—\$570; 32K—\$744; 8K add-on kits—\$162

(California residents add 6% sales tax)

Call or write Artec for details

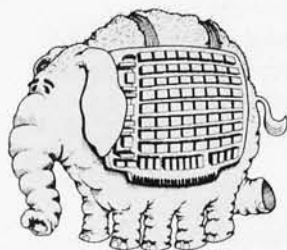

ARTEC ELECTRONICS, INC.

605 Old County Rd., San Carlos, CA 94070
Telephone (415) 592-2740

Operation Codes of the 8080, 8085, and Z80 Processors

D Martin Harrell
313 Hollyberry Rd
Severna Park MD 21146

Manual conversion between assembly language mnemonics and hexadecimal object code can be tedious — particularly if much code is involved. However, the task does not have to be overwhelming. A conversion table helps immensely and is also a good training aid for novice programmers. It presents the entire instruction set in compact form, revealing useful patterns, and also inconsistencies.

8080 and 8085 Operation Codes

Operation codes for the Intel 8080 and 8085 microprocessors are shown in table 1. The only difference between the instruction sets for this pair is that the 8085 has two additional instructions: the read-interrupt-mask instruction (mnemonic RIM, hexadecimal code 20), and the set-interrupt-mask instruction (mnemonic SIM, hexadecimal code 30). They allow the user to control interrupts and a serial I/O (input/output) line, thus making them useful additions.

The position of an 8080/8085 operation code in the table does not give a reliable clue about the implied addressing mode. Table 1 is generally organized according to the operands involved. Residing in the middle eight columns of the table (columns 4 thru 8) for example, are the instructions for single-byte move, arithmetic, and logical operations. (Length attributes in this article refer to data, rather than instruction length, unless other-

wise noted.) Regardless of the column, progression through the eight possible choices for the source (second) operand is always in the same sequence as the user moves down a column: registers B thru L; followed by memory reference; and finally, register A, the accumulator. Then, because each column has sixteen entries, the sequence repeats. If the arithmetic and logical instruction groups do not seem to conform to this rule, note that the first operand (always register A) is implied rather than stated explicitly.

This same sequence is used for advancing through choices for the destination (first) operand. In this case, however, progression is column to column from left to right, with each successive column containing two of the eight possible operands. The double-byte instructions also conform to this first-operand type of arrangement. Most of these appear in the first four columns of the table; however, the stack commands to PUSH and POP double-byte data are located at the far right in the top section.

An apparent inconsistency appears in the middle of the table. Hexadecimal code 76 is the instruction to halt the processor (HLT). Expected there instead is MOV M,M, the op code meaning "move the content of the memory location whose address is in the H and L register pair into that

Text continued on page 197

The Microcomputer as a Laboratory Instrument

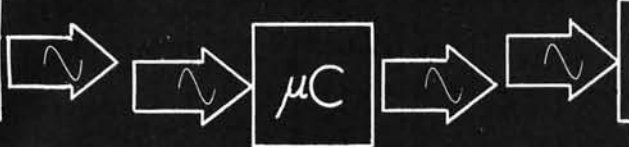

Turn your computer into

A spectrum analyzer, function generator, counter/timer, DVM, storage oscilloscope, filter, phase sensitive detector, colorimeter, data logger, pulse height analyzer, Fourier synthesizer, boxcar integrator, signal averager, waveform educator, computer of average transients.

We can help with

- ➡ ANALOG INTERFACES
- ➡ TRANSDUCERS
- ➡ SOFTWARE
- ➡ BREADBOARDS
- ➡ TEXTS
- ➡ WORKSHOPS

Write for complete information



CAMBRIDGE DEVELOPMENT LAB

44 Brattle Street
Cambridge, MA 02138

TRS-80* PERIPHERALS

DISK DRIVES \$349
40 tracks, with power supply & case and cable
VERBATIM DISKETTES \$3.00
DYSAN DISKETTES \$4.60

16k MEMORY KITS \$79
for TRS-80, APPLE, SORCERER w/jumpers and instructions
ONE YEAR GUARANTEE!!!!!!

PRINTERS from \$379
CENTRONICS, INTEGRAL DATA, NEC SPINWRITER, TEXAS INSTRUMENTS. ALL AT GREAT SAVINGS!!

TRS-80 computers in stock!!

We also carry APPLE, SORCERER, PET, SD SALES products. WE WILL NOT BE UNDERSOLD.

TRS-80 SOFTWARE		
GAMES	UTILITIES	BUSINESS
ANDROID NIM \$14.00 nim robots that wink and respond. Excellent graphics and sound.	NEWDOS+ \$99.00 Enhanced DOS. Contains many improvements over TRSDOS. 7 useful utilities built in. For 40 track use also.	GL, AR, AP, PAYROLL INTERACTIVE \$350. reports include unbilled invoices, open/closed accounts, ageing. Trial balance, income statement, balance sheet. Handles 200 accounts, 1750 transactions.
STAR TREK III \$14.00 Travel through the galaxy on the Enterprise and destroy klingons. New updated version.	SYSTEM INTEGRATION TEST \$29.00 tests memory, disk drives, and printer.	Stand alone of each \$95 INVENTORY II \$99.00 activity listing, complete listing, selected listing, minimum quantity search, 1000 items per disk
AIR RAID \$14.00 Real time shooting gallery.	MICROSOFT FORTRAN \$325.00 CPM \$150.00	ALL ABOVE PROGRAMS BY SBSG
SARGON:CHESS \$19.00 Best chess for TRS-80	RENUMBER \$14.00 disk	ELECTRIC PENCIL \$99.00 by Michael Shrayner
LIBRARY 100 \$49.00 100 games, utilities, and business programs in one package.	G2 LEVEL III \$49.00 FORTH by MMS \$65.00 GSF by RACET \$24.00	disk \$150.00 BEST word processor for the TRS-80
ADVENTURE \$14.00 disk \$24.95		

The above list is just a brief summary of some of our most popular software. We have a large selection of other software for many uses and for many computers. Documentation for any of our programs is available on request. If you have any questions, please call. We would like to hear from you.

TO ORDER, CALL OR WRITE:



MIDWEST COMPUTER PERIPHERALS

PO Box 437
WILMETTE, IL 60091
Order Desk (800) 323-4335
Info & IL residents
(312) 251-5028

NEW YEARS SPECIAL
10% Discount on all Software orders over \$100

*TRS-80 is a Registered Trademark of Tandy Corp.

HEATH® COMPATIBLE

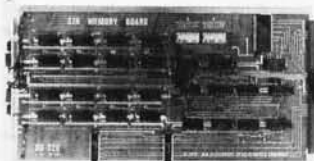

DG-32D 32K RAM FEATURES:

- ✓ Plugs into Heath® H8 Computer.
- ✓ Ready to use. Fully assembled, tested & burned in.
- ✓ Operates with existing Heath® memory.
- ✓ Protected memory Output Buffers in the event of Address error.
- ✓ Utilizes popular 4116 RAM devices.
- ✓ Memory Address DIP switch changeable.
- ✓ Arranged as 4 Independent 8K Blocks.
- ✓ Low Power Consumption: Less than 6 watts, typical.
- ✓ Transparent Refresh.
- ✓ One year guarantee.
- ✓ Compatible with all current H8 peripherals.

D•G Electronic Developments Co. brings you a totally compatible, fully assembled and tested 32K RAM for Heath® H8 computers. The DG-32D has less than 6 watts power consumption. This allows you to add a full 32K bytes of Random Access Memory without taxing or replacing your computer's power supply. Engineered to plug-in and run without any user modifications, the DG-32D can be

used with or without existing H8 RAM without modification. Protection of the memory output buffers is provided in the event of assigning two blocks to the same address space. The DG-32D is the ideal answer to expansion of the Heath® H8 computer. . . Low power consumption, low price, high capacity, total engineering and exacting production methods.

Heath® and H8 are registered trademarks of the Heath Corporation, Benton Harbor, Michigan.

BURNED IN 16K MEMORY CHIP SET H88-H89 \$89.00

ORDERING INFORMATION: DG-32D RAM available only from DG Electronic Developments Co., P.O. Box 1124, 1827 South Armstrong, Denison, Texas 75020. Check, money-order, VISA or Master Charge. Phone orders accepted on charge orders. NO COD's. Foreign orders add 30%. Texas residents add 5%. For VISA or Master Charge orders call 214-465-7805. \$479.00 freight prepaid. Allow three weeks for personal checks to clear banks.

D•G ELECTRONIC DEVELOPMENTS CO.

32K RAM \$479⁰⁰

DESKS AND STUFF

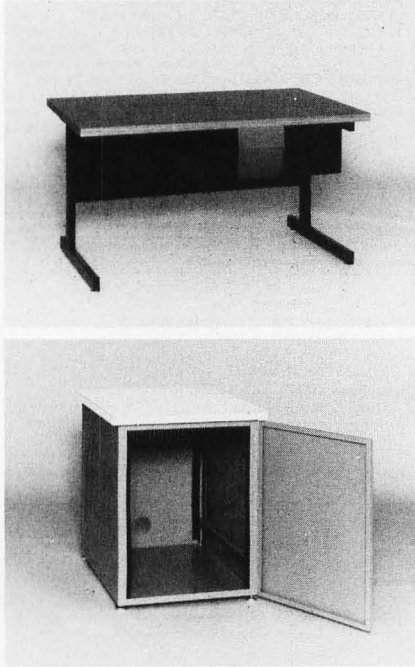

Computer terminals, business systems, lab components . . . they all need desks and enclosures. That's what we're all about. Computer Furniture and Accessories offers a standard line of furniture suitable for a wide variety of applications. Handsome, rugged, economical furniture in all shapes, sizes and colors. Basic models shipped from stock in days, not months. And we're nice people to deal with. What more could you ask for?

CF&A

**Computer Furniture and
Accessories, Inc.**
1441 West 132nd Street
Gardena, CA 90249
(213) 327-7710

0	1	2	3	4	5	6	7	8	9	A	B	C	D	E	F
NOP		RST	STX	MOV B,B	MOV D,B	MOV H,B	MOV M,B	ADD B	SUB B	ANA B	ORA B	RNZ	RNC	RPO	RP
LXI B	LXI D	LXI H	LXI SP	MOV B,C	MOV D,C	MOV H,C	MOV M,C	ADD C	SUB C	ANA C	ORA C	POP B	POP D	POP H	POP PSW
STAX B	STAX D	SHLD	STA	MOV B,D	MOV D,D	MOV H,D	MOV M,D	ADD D	SUB D	ANA D	ORA D	JNZ	JNC	JFO	JP
INX B	INX D	INX H	INX SP	MOV B,E	MOV D,E	MOV H,E	MOV M,E	ADD E	SUB E	ANA E	ORA E	JMP	OUT	XTHL	DI
INR B	INR D	INR H	INR M	MOV B,H	MOV D,H	MOV H,H	MOV M,H	ADD H	SUB H	ANA H	ORA H	CNZ	CNC	CPO	CP
DCR B	DCR D	DCR H	DCR M	MOV B,L	MOV D,L	MOV H,L	MOV M,L	ADD L	SUB L	ANA L	ORA L	PUSH B	PUSH D	PUSH H	PUSH PSW
MVI B	MVI D	MVI H	MVI M	MOV B,M	MOV D,M	MOV H,M	HLT	ADD M	SUB M	ANA M	ORA M	ADI	SUI	ANI	ORI
RLC	RAL	DAA	STC	MOV B,A	MOV D,A	MOV H,A	MOV M,A	ADD A	SUB A	ANA A	ORA A	RST 0	RST 16	RST 32	RST 48
				MOV C,B	MOV E,B	MOV L,B	MOV A,B	ADC B	SBB B	XRA B	CMF B	RZ	RC	RPE	RM
DAD B	DAD D	DAD H	DAD SP	MOV C,C	MOV E,C	MOV L,C	MOV A,C	ADC C	SBB C	XRA C	CMF C	RET		PCHL	SPHL
LDAX B	LDAX D	LHLD	LDA	MOV C,D	MOV E,D	MOV L,D	MOV A,D	ADC D	SBB D	XRA D	CMF D	JZ	JC	JPE	JM
DCX B	DCX D	DCX H	DCX SP	MOV C,E	MOV E,E	MOV L,E	MOV A,E	ADC E	SBB E	XRA E	CMF E		IN	XCHG	EI
INR C	INR E	INR L	INR A	MOV C,H	MOV E,H	MOV L,H	MOV A,H	ADC H	SBB H	XRA H	CMF H	CZ	CC	CPE	CM
DCR C	DCR E	DCR L	DCR A	MOV C,L	MOV E,L	MOV L,L	MOV A,L	ADC L	SBB L	XRA L	CMF L	CALL			
MVI C	MVI E	MVI L	MVI A	MOV C,M	MOV E,M	MOV L,M	MOV A,M	ADC M	SBB M	XRA M	CMF M	AGI	SBI	XRI	CPI
RRC	RAR	CMA	CNC	MOV C,A	MOV E,A	MOV L,A	MOV A,A	ADC A	SBB A	XRA A	CMF A	RST 8	RST 24	RST 40	RST 56

Table 1: Mnemonics of the operation codes of the 8080 and 8085 microprocessors arranged conveniently for conversion to the hexadecimal object code. This task is aided by the organizational consistency of the instruction set. The two instructions (RIM and SIM) found only in the 8085 are indicated by shading.

Text continued from page 194:

same memory location." The expected instruction is effectively just a slow equivalent of the no operation (NOP) located at hexadecimal 00. Hence, its replacement by the halt command improves, rather than degrades the power of the instruction set. Still, I wonder why an otherwise empty spot in the table was not chosen — as was done for the two additional 8085 instructions.

The right quarter of the table mainly contains program branching and data exchange instructions. Excluding the previously mentioned stack commands, none of these have explicit operands so the previously discussed organization is impossible. The miscellaneous nature of these instructions also tends to prevent predictable order.

Nonetheless, the op codes in this area have a consistent structural style. Most are arranged in complementary order, with mutually exclusive conditions placed in the same column, separated by eight rows. The group of return instructions is typical. The unconditional return from subroutine command is hexadecimal C9. Starting immediately above it and proceeding to the right, four of the eight conditional return instructions are found. The other four (the complements) are eight rows higher.

The order in which these conditions appear is uniform from group to group. To determine that this is so, compare similar elements of the call, jump, and return groups. The unconditional jump (JMP) instruction is a curious exception. Its expected code is CB, but it actually appears eight rows higher in the table. Such exceptions are few enough not to be bothersome.

Z80 Operation Codes

The Z80 is an enhanced version of the 8080. It runs faster, has twice as many general purpose registers, and has a much larger instruction set. Included as a subset in this instruction is the entire repertoire of the 8080. (This compatibility exists at the machine language level, but not the assembly language level; standard mnemonics and assembly language formats for the two processors differ considerably.) Thus, in hexadecimal object form, almost any program written for the 8080 will produce identical results when executed by a

P&T CP/M[®]2 unleashes the POWER of your TRS-80 MODEL II

Pickles & Trout has adapted CP/M 2, one of the world's most popular operating systems, to the TRS-80 Model II and the result is spectacular:

- 596K bytes of usable storage at double density
- Runs both single and double density disks with automatic density select
- Single drive backup
- Multi-drive software can run on a 1 drive system
- Operates with 1, 2, 3, or 4 drives
- Full function CRT control
- Type-ahead buffer for keyboard input
- Full access to both serial ports and parallel printer port
- Fully software programmable serial ports
- Loads an 18K Basic in 2.5 seconds
- Full compatibility with existing CP/M software and application packages
- Full set of 7 CP/M manuals plus our own for the TRS-80 Model II

Introductory price: \$175

Prepaid, COD, Mastercharge or Visa orders accepted. Shipping extra. California residents add 6% sales tax.



PICKLES & TROUT

P.O. BOX 1206, GOLETA, CA 93017, (805) 967-9563

CP/M is a trademark of Digital Research Inc.

TRS-80 is a trademark of Tandy Corp.



NEW PETS* - OLD PETS*

NAIL* has programs for all of them. Whether your PET* is the original 8K, or the original 8K with an expanded memory, or the new 16K or 32K full keyboard machine, NAIL has programs for you. Here are the latest NAIL programs for the new 16K and 32K PETS with PET floppy disk units: SYS32000* (for new 32K PET) SYS16000* (for new 16K PET). These machine language Systems are available for immediate shipment on disk, tape, or PROM. Once loaded from tape or disk, the System remains resident and undisturbed until power is turned off. Immediately at your command are the following 22 functions:

- (1). Load machine language program from disk. (2). Load machine language program from tape. (3). Save machine language program on disk. (4). Save machine language program on tape. (5). Dump BASIC program on tape for later appending. (6). Dump BASIC program on disk for later appending. (7). Append BASIC program from tape. (8). Append BASIC program from disk. (9). Renumber BASIC program with standard beginning line number and increment. (10). Renumber BASIC program with custom beginning line number and increment. (11). Display contents of registers. (12). Display memory. (13). Execute machine language program starting at address in program counter. (14). Execute machine language program beginning at address given. (15). Exit to BASIC. (16). Compact BASIC program, removing all unnecessary spaces. (17). Eliminate from BASIC program range of line numbers given. (18). Display directory for disk drive #0. (19). Display directory for disk drive #1. (20). Trace execution of BASIC program. (21). Turn off Trace. (22). Help.

A NEW DIMENSION IN PROGRAMMING STYLE

By using the above Systems, you will develop a new and powerful programming style. For example, you can build up a library of powerful subroutines from your BASIC programs. Use the Eliminate function to remove all of the BASIC program except the subroutine you wish to isolate. Then, with the renumber function, you can give this subroutine a distinctive set of line numbers. Now, with the Dump command, you store this subroutine on your disk reserved for your library. Eventually you will have a large selection of subroutines from which to draw. Now, when you write a new BASIC program, you can simply drop in any of the subroutines from your library with the Append command. Use the Directory command to review your library on disk. Both the System and your BASIC program remain undisturbed as you review the contents of your disks. The subroutine can be placed anywhere you want it, at the beginning, at the end or any place in between. You do this by renumbering the BASIC program in the machine, and when the subroutine is Appended, it is automatically merged with the program already in the machine, with all line numbers in proper sequence. Now you can renumber the entire program, then Compact it to save memory, and then turn on Trace to watch it execute line by line with each line number shown on the screen as it executes.

SYS32000* for the new 32K PET - SYS16000* for the new 16K PET - \$100 on disk or tape, \$200 for PROM which plugs in to the PET ROM expansion socket.

For complete description of this and other programs, write for catalog #342

NAIL, Box F, Mobile, AL. 36601

*PET is a trademark of Commodore Business Machines. NAIL, SYS32000 and SYS16000 are trademarks of National Artificial Intelligence Laboratory. © 1979 NAIL.

Texas Instruments Home Computer TI-99/4

You Don't Have To Be A Genius To Own The TI Home Computer



(The genius is built in)

in stock now!

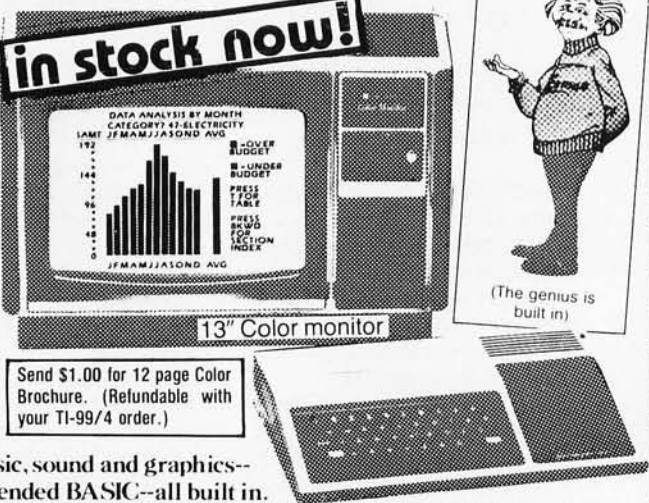

Send \$1.00 for 12 page Color Brochure. (Refundable with your TI-99/4 order.)

- Math Speech Dict \$ 29.95
- Modem 224.95
- Thermal Printer 399.95
- RS 232 Interface 224.95
- Disk-Controller 299.95
- Disk Drive 499.95
- Joystick (pair) 34.95
- Dual Cas-sette Cable 15.95
- Video Graphs 19.95
- Early Learning Fun 29.95
- Beginning Grammar 29.95
- Early Rdg & Spch Dict 54.95
- Diagnostic 29.95
- Home Financial Decisions 29.95
- Football 29.95
- Physical Fitness 29.95
- Household Budget Mgt 44.95
- Tax/ Invest Rec Kpg 69.95
- Investment Analysis 54.95
- Personal Record Keeping 49.95
- Statistics 54.95
- Video Chess 69.95
- Number Magic 19.95
- Speech Editor 44.95
- Speech Synthesizer 149.95
- Terminal Emulator 44.95

Superior color, music, sound and graphics--and a powerful extended BASIC--all built in. Plus a unique, new Solid State Speech Synthesizer.

ORDER NOW SAVE \$150



FACTORY DIRECT SALES
Dept. 40
1317 E. Colorado St.
Glendale, CA 91205
Phone: (213) 245-1417

ORDER TODAY

Retail Store Hours: Tues.-Fri. 10AM to 6PM
Sat. 9AM to 5PM Closed Sunday & Monday

20% deposit required on C.O.D. orders

Check Money Order VISA Master Charge

CA residents add 6% sales tax (No C.O.D. outside continental U.S.A.)

SATISFACTION GUARANTEED OR YOUR MONEY BACK!

Price subject to change without notice. Refunds guaranteed.

- 26K ROM
- Up to 72K total memory capacity
- 16-color graphics capability
- Built-in equation calculator

Retail Price \$1150

Your Price

\$999⁹⁵

Delivery subject to product availability by manufacturer.

Copyright © 1979 Factory Direct Sales

Z80. Because of the Z80's generally higher speed, software timing loops are an exception to this upward compatibility feature. [Editor's note: There is also a slight difference in the operation of the parity flag . . . RSS]

The similarities of the two instruction sets can be seen by comparing corresponding positions of table 1 and table 2. Table 2 is the basic conversion table for the Z80. For every valid 8080 instruction in table 1, its correspondent in table 2 produces logically equivalent results. The differences between the two instruction sets stem from the twelve positions unused by the 8080. These, which are clearly indicated in table 2, are used to greatly expand the Z80's capability.

The Zilog Corp used the seven unfilled positions on the left side of table 1 and the uppermost one on the right side to give the Z80 processor the ability to perform relative branching and to exchange the contents of its two sets of registers. However, the use of hexadecimal codes 20 and 30 for two of the jump relative instructions means that the Z80 is not as compatible with the 8085 as it is with the 8080.

The real expansion of the Z80's instruction set over that of the 8080 is the result of the interesting use of the four other empty spaces in table 1. In essence, the Z80 uses them as pointers to four additional 16 by 16 tables, thus increasing the number of possible op codes by 1532. (The Z80 does not use most of these, but flexibility for future expansion is certainly there.) Had this innovative use of the unimplemented codes not been done, the Z80 would have been limited to 256 different op codes, which is only twelve more than the 8080.

There is a penalty for this flexibility: all instructions in these expansion sets must be multibyte. The first byte identifies the appropriate expansion instruction set, after which, the second byte identifies the operation to be performed. Sometimes there is an additional third or fourth byte to provide data or addressing information.

Shift, Rotate, and Bit Manipulation Instructions

Consider these pointer instructions one at a time. All of the instructions which begin with hexadecimal CB are contained in table 3. All of the direct-

S-100 INTELLIGENT COLOR GRAPHICS BOARD CGS-808

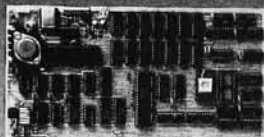

The CGS-808 is an intelligent color graphics board for the S-100 bus. The CGS-808 is simple to use, just plug it in and run. It requires no memory space and little software overhead.

Features:

- MC6847 video display generator, on-board 8085 microprocessor.
- Eight colors—green, yellow, blue, red, buff, cyan, magenta, orange.
- 11 programmable modes ranging from 64x64 to 256x192 in 4 and 1 colors.
- I/O mapped for true S-100 compatibility.

Software:

- Firmware Pack I—clear screen, change mode, plot point, draw line, alphanumeric/semigraphic, read/write screen.
- Firmware Pack II—relative and absolute modes, ellipses, alphanumerics (two sizes), 3D hidden dot.
- Firmware Pack III—shaped ellipses, shaded polygons, chain lines, move point, move line, bar graph, expansion port driver.

CGS-808B (Bare "Kit") \$125.00

(Includes PC board, documentation, MC6847, MC1372, 8085 and 2708 with Firmware Pack I)

CGS-808A (Assembled and Tested) \$399.00

Firmware Pack II \$ 60.00

Firmware Pack III \$ 99.00

SubLogic 2D Graphics Driver \$ 35.00

SubLogic 3D Graphics Driver \$ 30.00

Phone Orders Welcome — Visa/Mastercharge — Add \$3.00 for Shipping & Handling
California Residents Add 6% Sales Tax — Call or write for your free brochure.



BIOTECH ELECTRONICS
P.O. Box 485, Ben Lomond, CA 95005
(408) 338-2686

First Nybble

	0	1	2	3	4	5	6	7	8	9	A	B	C	D	E	F
0	NOP	BRK	JR #Z,e	JR #C,e	LD B,B	LD D,B	LD H,B	LD (HL),B	ADD A,B	SUB B	AND B	OR B	RET NZ	RET NC	RET PO	RET P
1	LD BC,nn	LD DE,nn	LD HL,nn	LD SP,nn	LD B,C	LD D,C	LD H,C	LD (HL),C	ADD A,C	SUB C	AND C	OR C	POP BC	POP DE	POP HL	POP AF
2	LD (BC),A	LD (DE),A	LD (nn),HL	LD (nn),A	LD B,D	LD D,D	LD H,D	LD (HL),D	ADD A,D	SUB D	AND D	OR D	JP NZ,nn	JP NC,nn	JP PO,nn	JP P,nn
3	INC BC	INC DE	INC HL	INC SP	LD B,E	LD D,E	LD H,E	LD (HL),E	ADD A,E	SUB E	AND E	OR E	JP nn	OUT (n),A	EX (SP),HL	DI
4	INC B	INC D	INC H	INC HL	LD B,H	LD D,H	LD H,H	LD (HL),H	ADD A,H	SUB H	AND H	OR H	CALL NZ,nn	CALL NC,nn	CALL PO,nn	CALL P,nn
5	DEC B	DEC D	DEC H	DEC HL	LD B,L	LD D,L	LD H,L	LD (HL),L	ADD A,L	SUB L	AND L	OR L	PUSH BC	PUSH DE	PUSH HL	PUSH AF
6	LD B,n	LD D,n	LD H,n	LD (HL),n	LD B,(HL)	LD D,(HL)	LD H,(HL)	HAFT	ADD A,(HL)	SUB (HL)	AND (HL)	OR (HL)	ADD A,n	SUB n	AND n	OR n
7	RCA	RLA	DAA	SCF	LD B,A	LD D,A	LD H,A	LD (HL),A	ADD A,A	SUB A	AND A	OR A	RET OOH	RST 10H	RST 20H	RST 30H
8	ADD HL,BC	ADD HL,DE	ADD HL,HL	ADD HL,SP	LD C,B	LD E,B	LD L,B	LD A,B	ADC A,B	SEC A,B	XOR B	CP B	RET Z	RET C	RET PE	RET M
9	LD A,(BC)	LD A,(DE)	LD HL,(nn)	LD A,(nn)	LD C,C	LD E,C	LD L,C	LD A,C	ADC A,C	SEC A,C	XOR C	CP C	RET	EX	JP (HL)	LD SP,HL
A	DEC BC	DEC DE	DEC HL	DEC SP	LD C,D	LD E,D	LD L,D	LD A,D	ADC A,D	SEC A,D	XOR D	CP D	JP Z,nn	JP C,nn	JP PE,nn	JP M,nn
B	INC C	INC E	INC L	INC A	LD C,E	LD E,E	LD L,E	LD A,E	ADC A,E	SEC A,E	XOR E	CP E	See Table J	IN A,(n)	EX DE,HL	EI
C	DEC C	DEC E	DEC L	DEC A	LD C,H	LD E,H	LD L,H	LD A,H	ADC A,H	SEC A,H	XOR H	CP H	CALL Z,nn	CALL C,nn	CALL PE,nn	CALL M,nn
D	LD C,n	LD E,n	LD L,n	LD A,n	LD C,L	LD E,L	LD L,L	LD A,L	ADC A,L	SEC A,L	XOR L	CP L	CALL nn	See Table J	See Table B	See Table 6
E	RCA	RRA	CPL	CCF	LD C,A	LD E,A	LD L,A	LD A,A	ADC A,A	SEC A,A	XOR A	CP A	ADC A,n	SEC A,n	XOR n	CP n
F					LD C,A	LD E,A	LD L,A	LD A,A	ADC A,A	SEC A,A	XOR A	CP A	RST 08H	RST 18H	RST 28H	RST 38H

Second Nybble

Table 2: Mnemonics of the operation codes of the Z80 microprocessor arranged for conversion to hexadecimal object code. Corresponding positions of table 1 and table 2 generally perform the identical function, despite differences in notation. Enhancements of the 8080 instruction set are indicated by shading. Mnemonics used here are those specified by Zilog.

MEMOREX Floppy Discs

Lowest prices. **WE WILL NOT BE UNDERSOLD!** Buy any quantity 1-1000. Visa, Mastercharge accepted. Call free (800)235-4137 for prices and information. All orders sent postage paid.



PACIFIC EXCHANGES
100 Foothill Blvd.
San Luis Obispo, CA
93401. (In Cal. call
(805) 543-1037.)

Circle 286 on inquiry card.

16 K RAMS & RAM CONTROLLERS

- 16 K X 1 DYNAMIC RAMS M4116P3
- 200 NSEC ACCESS/375 NSEC CYCLE TIMES
- 16 PIN/TTL COMPATIBLE
- ALL CHIPS BURNED IN AND FULLY TESTED
- PRICE WITH DATA SHEET \$68.00 IN QTY OF 8/THAT'S \$8.50 EACH

6800/6502 64K BYTE RAM & CONTROLLER SET
MAKE 64K BYTE MEMORY FOR YOUR 6800 OR 6502
THIS SET INCLUDES:

- 32 MSK 4116-3, 16K X 1, 200 NSEC RAMS
- 1 MC3480 MEMORY CONTROLLER
- 1 MC3242A MEMORY ADDRESS MULTIPLEXER AND COUNTER
- DATA & APPLICATION SHEETS. PARTS TESTED AND GUARANTEED.

\$295.00 PER SET

DYNAMIC MEMORY CONTROLLER MC3480L
GENERATES RAS/CAS & REFRESH TIMING FOR 16K TO 64K BYTE MEMORIES
PRICE WITH DATE SHEET: \$13.95 EACH

MEMORY ADDRESS MUX/COUNTER MC3242AP
MUX ADDRESS & REFRESH COUNTER FOR 16K TO 64K BYTE MEMORIES
PRICE WITH DATA SHEET: \$12.50 EACH

QUANTITY DISCOUNTS AVAILABLE

ALL ORDERS POSTPAID U.S. FUNDS ON INTERNATIONAL ORDERS CHECK OR MONEY ORDER. VISA BA/MC ALSO ACCEPTED SEND ACT. NO. EXPIRATION DATE & RETURN BANK NO. WITH SIGNED ORDER. CALIF. RESIDENTS PLEASE ADD 6% SALES TAX. PHONE ORDERS (714) 633-4460

MEASUREMENT SYSTEMS & CONTROLS, INC.

MEMORY DEVICES DIVISION
867 NORTH MAIN ST. ORANGE, CA 92668

CASSETTE DUPLICATION

TRS-80 (I & II), PET, APPLE, KIM, ATARI

Quality software duplication is more than copying cassettes. Microsette duplication uses a proprietary high speed duplicator designed specifically for computer program duplication. The finished products are of consistent quality, guaranteed to load. Minimum order is 100 with discounts for higher quantities. Call (415) 968-1604 for details.



MICROSETTE CO.
475 Ellis Street
Mt. View, CA 94043

Circle 288 on inquiry card.

new **ECONOMICAL STD BUS* PLUGBORDS FROM *Vector* MAKE SYSTEM EXPANSION AND INTERFACE BOARDS FAST 'N EASY**

4610 for soldering or wire wrapping. Mounts 20 16-pin DIPs or combinations.
4610-2 for wire wrap. Mounts 35 16-pin DIPs or combinations.
4610-1— Hi density, wrap or solder. Mounts 59 16-pin DIPs compact, 47 spaced.

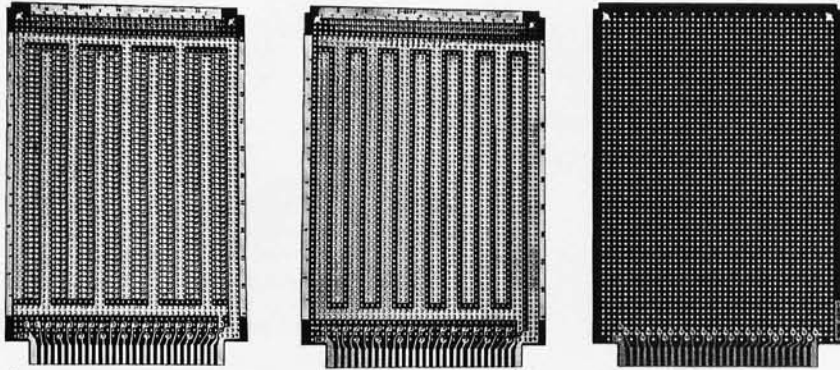

*Card edge connector pins are connected to power and ground buses per STD BUS convention. Tinned bare boards for total freedom in component mounting.

All models have .042 holes on 0.1 inch grid. 4 1/2 x 6 1/2 x .062 plugboards, 28/56 nickel-plated gold flashed contacts on .125" centers. Card Extender 3690-16 available.
 4610 - \$18.95 4610-1 - \$15.95 4610-2 - \$18.95 3690-16 - \$25.00
 Plus full supporting line of Card Cages, mating connectors, w.w. tools, terminals, DIP Sockets. Available now thru AVID Distributors & Factory Direct.

Vector Electronic Company INCORPORATED
 Prices subject to change without notice. *Pro-Log/Mostek developed. 719079

mode instructions to shift or rotate (in either direction) any byte in memory or in any of the eight active registers are located here. Table 3 also contains the direct-mode instructions to set, reset, or test any bit in any of these bytes. All of these operations have a length of two bytes. Interestingly, there are more valid instruction combinations derived from the ten basic instructions in this table than there are in the entire 8080 set.

Two features of table 3 are notable. The first is the absence of a "shift left logical" counterpart to the SRL command group. The shift left logical counterpart is not there because it is not needed; the "arithmetic shift left" instructions in column 2 (hexadecimal) accomplish this function. The use of the same general organizational rules indicated earlier for the 8080 is the more important of the two properties of this table. Such uniformity is a good aid in locating instructions in this table.

Indexed Instructions

Instructions beginning with hexadecimal DD are in one of two indexed classes of instructions. These use the IX and IY registers respectively in forming a data address. Those related to the former are depicted in table 4 and its associated table 5.

The analogy between tables 2 and 4 and between tables 3 and 5 is striking. The organizational patterns are identical — even to the point of using the same expansion technique. They should be identical. Each of these indexed instructions was formed by replacing the (HL) operand of an equivalent register-indirect instruction with the indexed notation (IX+d). Thus, every operation that can be performed in the register-indirect mode by the 8080 or Z80 can also be performed in the indexed mode by the Z80.

The resulting positional equivalence between the two sets of tables is most helpful in determining the required hexadecimal code for the indexed instructions. An easy way to do this without having to refer to tables 4 or 5 is to first select from table 2 or 3 (as appropriate) the hexadecimal code for the register-indirect form of the desired operation. Then place a DD prefix in front of this code if the operation was found in table 2, or a DDCB prefix, if found in table 3.

Text continued on page 207

The Self-Indexing Query System

WHAT'SIT?

Wow! How'd All That Stuff get In There?

COMPUTER HEADWARE

BOX 14694
 SAN FRANCISCO 94114

Second Nybble	0	1	2	3	4	5	6	7	8	9	A	B	C	D	E	F
0	RRC B	RL B	SLA B		BIT 0,B	BIT 2,B	BIT 4,B	BIT 6,B	RES 0,B	RES 2,B	RES 4,B	RES 6,B	SET 0,B	SET 2,B	SET 4,B	SET 6,B
1	RRC C	RL C	SLA C		BIT 0,C	BIT 2,C	BIT 4,C	BIT 6,C	RES 0,C	RES 2,C	RES 4,C	RES 6,C	SET 0,C	SET 2,C	SET 4,C	SET 6,C
2	RRC D	RL D	SLA D		BIT 0,D	BIT 2,D	BIT 4,D	BIT 6,D	RES 0,D	RES 2,D	RES 4,D	RES 6,D	SET 0,D	SET 2,D	SET 4,D	SET 6,D
3	RRC E	RL E	SLA E		BIT 0,E	BIT 2,E	BIT 4,E	BIT 6,E	RES 0,E	RES 2,E	RES 4,E	RES 6,E	SET 0,E	SET 2,E	SET 4,E	SET 6,E
4	RRC H	RL H	SLA H		BIT 0,H	BIT 2,H	BIT 4,H	BIT 6,H	RES 0,H	RES 2,H	RES 4,H	RES 6,H	SET 0,H	SET 2,H	SET 4,H	SET 6,H
5	RRC L	RL L	SLA L		BIT 0,L	BIT 2,L	BIT 4,L	BIT 6,L	RES 0,L	RES 2,L	RES 4,L	RES 6,L	SET 0,L	SET 2,L	SET 4,L	SET 6,L
6	RRC (HL)	RL (HL)	SLA (HL)		BIT 0,(HL)	BIT 2,(HL)	BIT 4,(HL)	BIT 6,(HL)	RES 0,(HL)	RES 2,(HL)	RES 4,(HL)	RES 6,(HL)	SET 0,(HL)	SET 2,(HL)	SET 4,(HL)	SET 6,(HL)
7	RRC A	RL A	SLA A		BIT 0,A	BIT 2,A	BIT 4,A	BIT 6,A	RES 0,A	RES 2,A	RES 4,A	RES 6,A	SET 0,A	SET 2,A	SET 4,A	SET 6,A
8	RRC B	RR B	SRA B	SRL B	BIT 1,B	BIT 3,B	BIT 5,B	BIT 7,B	RES 1,B	RES 3,B	RES 5,B	RES 7,B	SET 1,B	SET 3,B	SET 5,B	SET 7,B
9	RRC C	RR C	SRA C	SRL C	BIT 1,C	BIT 3,C	BIT 5,C	BIT 7,C	RES 1,C	RES 3,C	RES 5,C	RES 7,C	SET 1,C	SET 3,C	SET 5,C	SET 7,C
A	RRC D	RR D	SRA D	SRL D	BIT 1,D	BIT 3,D	BIT 5,D	BIT 7,D	RES 1,D	RES 3,D	RES 5,D	RES 7,D	SET 1,D	SET 3,D	SET 5,D	SET 7,D
B	RRC E	RR E	SRA E	SRL E	BIT 1,E	BIT 3,E	BIT 5,E	BIT 7,E	RES 1,E	RES 3,E	RES 5,E	RES 7,E	SET 1,E	SET 3,E	SET 5,E	SET 7,E
C	RRC H	RR H	SRA H	SRL H	BIT 1,H	BIT 3,H	BIT 5,H	BIT 7,H	RES 1,H	RES 3,H	RES 5,H	RES 7,H	SET 1,H	SET 3,H	SET 5,H	SET 7,H
D	RRC L	RR L	SRA L	SRL L	BIT 1,L	BIT 3,L	BIT 5,L	BIT 7,L	RES 1,L	RES 3,L	RES 5,L	RES 7,L	SET 1,L	SET 3,L	SET 5,L	SET 7,L
E	RRC (HL)	RR (HL)	SRA (HL)	SRL (HL)	BIT 1,(HL)	BIT 3,(HL)	BIT 5,(HL)	BIT 7,(HL)	RES 1,(HL)	RES 3,(HL)	RES 5,(HL)	RES 7,(HL)	SET 1,(HL)	SET 3,(HL)	SET 5,(HL)	SET 7,(HL)
F	RRC A	RR A	SRA A	SRL A	BIT 1,A	BIT 3,A	BIT 5,A	BIT 7,A	RES 1,A	RES 3,A	RES 5,A	RES 7,A	SET 1,A	SET 3,A	SET 5,A	SET 7,A

Second Nybble

Table 3: Enhancement operation codes of the Z80 invoked by the hexadecimal CB instruction prefix. These CB class operations give bit manipulation, data shifting, and enhanced rotation capability to the Z80.

PASCAL

NOW — A GREAT IDEA — IMPROVED!

The advantages of PASCAL are well recognized and accepted. Now, PASCAL+[®] makes a good thing even better.

PASCAL+ is a pcode compiler and run-time package with extensions. Not a subset, it is a complete PASCAL and is fully CP/M[®] compatible—because it's specifically designed for CP/M. It gives you all the standard PASCAL benefits—unlimited nesting of procedures and compound statements; data types (records, arrays, sets, user defined types, etc.); 14 digit BCD floating point package—PLUS extensions to support commercial applications and reduce programming effort:

- Powerful dynamic storage management system / dynamic variable allocation procedures NEW & DISPOSE are fully implemented / automatic dynamic storage compression / user assigned pointer variables allow access to any part of storage—example: a memory mapped video display could be accessed as an array of characters. **External procedures/functions may be separately compiled and disk-stored in relocatable format** / allows development of large programs, not limited by main storage size / automatic loading into dynamic storage when procedure is referenced / automatic purging from dynamic storage by a least-recently-used algorithm. **Powerful disk I/O facilities** / data may be stored in ASCII text or space-saving binary format / random access by relative byte address. perfect for index file structures and data base systems / random access by relative record number. **String and structured variables** / entire arrays and records. strings of different lengths may be assigned, compared, input or output with simple statements / function return values may be string, array, record. **CASE statement with ELSE clause** / CASE labels may be full expressions. **More readable identifiers** / up to 32 characters / may contain underline characters. **Assembler routine interface.**
- Hex constants.

Documentation: PASCAL User Manual & Report by Jensen & Wirth and PASCAL+ User Manual: \$225. Order PASCAL+ today from:



JRT SYSTEMS, INC
 P.O. Box 22365
 San Francisco,
 CA 94122
 Telephone 415-566-4240
 (California residents add sales tax.)

[®]CP/M is a registered trademark of Digital Research

Bringing Music Home

LET MICRO MUSIC TURN YOUR APPLE II INTO A FAMILY MUSIC CENTER!

VISIT THE APPLE DEALER NEAREST YOU AND ASK FOR A DEMONSTRATION OF MMI'S MUSIC COMPOSER

Suggested retail price ~~\$220.~~ **\$179.**

MMI's Music Composer™ Library. Updates and additions to enhance your MMI Home Music Center.

- Graphic Entry for Music Notation Available NOW! Incorporates the very best of all existing music entry systems. Available at cost to Music Composer owners.
- Envelope Shaping Available June 1 Turn your MMI Home Music Center into a full scale music synthesizer.
- Digisong Pak's "Disco, Rock & Jazz" Available NOW! "Red Hot Bach" Available NOW! "Oldies But Goodies" Available NOW! "Dixieland Swingers" Available NOW!
- Auto Digisong Player Available NOW! Sequence your own tunes, or Digisong Pak selections for fully automatic playing!
- Experiment Package Available April 1 Allows access to the heart of the MMI machine language interpreter that produces MMI musical sound and graphics.

MMI's "Learning for the Fun of It" Library. Challenging, exciting music games that train students while they have fun.

Series 1: Musical Games and other Tone-Foolery

- Maestro's Magic Speller Available NOW!
- Music Lover's Guide to Composers Available April 1
- Music Lover's Guide to Musical Symbols Available April 1
- Music Lover's Guide to Italian Terms Available April 1
- Music Lover's Guide to Musical Instruments Available April 1
- Music Lover's Guide to General Terms Available April 1

Series 2: The University Series, super sophisticated additions to the MMI Library, designed by leading educators.

- Melodious Dictator Available NOW!
- Rhythmical Dictator Available April 1
- Harmonical Dictator Available April 1
- Interval Mania Available NOW!
- Chord Mania Available April 1

Numerous additional music programs are available or in progress. For information, or to be placed on MMI's Software Up-date mailing list, write or call:



Micro Music Inc (309) 452-6991
309 Beaufort, University Plaza, Normal, IL 61761

First Nybble	0	1	2	3	4	5	6	7	8	9	A	B	C	D	E	F
0																
1		LD IX,nn						LD (IX+d),B							POP IX	
2		LD (nn),IX						LD (IX+d),C								
3		INC IX						LD (IX+d),D								
4				INC (IX+d)				LD (IX+d),E								
5				DEC (IX+d)				LD (IX+d),H								
6				LD (IX+d),n	LD B,(IX+d)	LD D,(IX+d)	LD H,(IX+d)	LD (IX+d),L	ADD A,(IX+d)	SUB (IX+d)	AND (IX+d)	OR (IX+d)				
7																
8																
9	ADD IX,BC	ADD IX,DE	ADD IX,IX	ADD IX,SP												
A			LD IX,(nn)													
B			DEC IX													
C																
D																
E					LD C,(IX+d)	LD E,(IX+d)	LD L,(IX+d)	LD A,(IX+d)	ADC A,(IX+d)	SBC A,(IX+d)	XOR (IX+d)	OP (IX+d)				
F																

Table 4: Operations of the Z80 invoked by the instruction prefix DD. These provide indexed-mode instructions equivalent to the indirect-mode instructions and employ the IX register.

Hire a fast thinker.

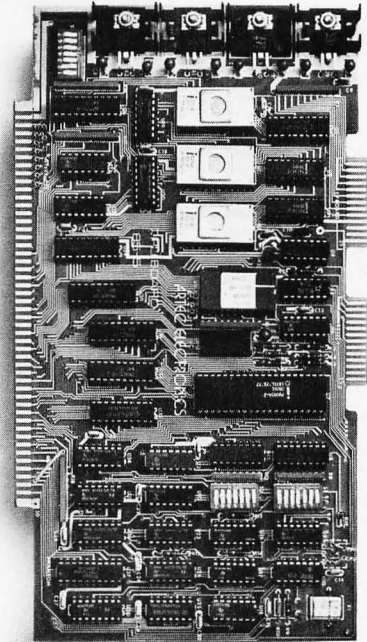

5 MHz CPU Card

- Intel 8085A-2 microprocessor
- Hardware floating point
- Performs calculations six times faster than other CPUs
- On-board monitor in PROM
- 1K RAM scratch pad
- Keyboard or RS232C terminal
- Variable clock frequency

PRICE—\$850

(California residents add 6% sales tax)

Call or write Artec for details.

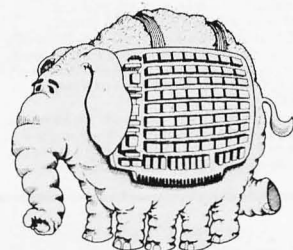

ARTEC ELECTRONICS, INC.

605 Old County Rd., San Carlos, CA 94070
Telephone (415) 592-2740

Second Nybble		First Nybble															
		0	1	2	3	4	5	6	7	8	9	A	B	C	D	E	F
0																	
1																	
2																	
3																	
4																	
5																	
6	RLC (IX+d)	RL (IX+d)	SIA (IX+d)	BIT 0, (IX+d)	BIT 2, (IX+d)	BIT 4, (IX+d)	BIT 6, (IX+d)	RES 0, (IX+d)	RES 2, (IX+d)	RES 4, (IX+d)	RES 6, (IX+d)	SET 0, (IX+d)	SET 2, (IX+d)	SET 4, (IX+d)	SET 6, (IX+d)		
7																	
8																	
9																	
A																	
B																	
C																	
D																	
E	RRC (IX+d)	RR (IX+d)	SRA (IX+d)	SRL (IX+d)	BIT 1, (IX+d)	BIT 3, (IX+d)	BIT 5, (IX+d)	BIT 7, (IX+d)	RES 3, (IX+d)	RES 5, (IX+d)	RES 7, (IX+d)	SET 1, (IX+d)	SET 3, (IX+d)	SET 5, (IX+d)	SET 7, (IX+d)		
F																	

Table 5: These DDCB-class operation codes are an indexed equivalent of the indirect-mode operation codes of the Z80 shown in table 3.

New CRT SENSATION!

You have been reading about our astounding high performance microcomputer products. Our X-9000 Pascal MICROENGINE™ CPU that executes **Pascal 13x faster than an LSI-11 and 3x faster than a PDP11-34.** Our X-920 CRT matches the features of the SOROC IQ140. Our X-8000 16-bit CPU **addresses 8M bytes** of memory directly and is coming soon!

*Trademark Western Digital Corporation

DISPLAY/EDIT TERMINAL Model X-920



\$920

\$820 (Without 18 function keys)

STANDARD FEATURES (partial list)

- Microprocessor controlled
- Serial RS232C and 20 ma current loop
- 10 baud rates—75 to 19,200
- 24 lines x 80 characters
- 96 ASCII displayable characters
- Upper and lower case
- 12 x 10 character resolution
- Dual intensity display
- Clear full intensity data only
- Programmable reverse video
- Programmable underline
- 105 keys with alpha lock
- 14 key numeric pad with decimal
- 16 special function keys
- 8 edit function keys
- 2 block transmission keys
- Self test mode
- Protect mode
- Block mode
- 80 storable tabbing
- Insert/delete character and line
- Scrolling
- Addressable cursor
- A host of other features, including cursor controls and remote commands such as clear to nulls, spaces, end of line, end of screen; set hi,lo,zero intensity; set blink; etc.
- **Optional** screen print & 2nd page memory

For our system or for yours, in commercial, technical, educational or personal applications, the **Computex X-920 is unmatched** in its class.

All features of the Hazeltine 1400 and ADM-3A

- Plus:** 128 ASCII characters ...
 7 x 10 matrix ... Reverse video ... Print key ...
 Shiftlock ... Transparent mode ... Backspace ...
 Tabbing ... Integrated numeric pad.



\$799

List price ~~\$956~~

PERKIN-ELMER (Model 550)

Off the shelf delivery now on the Model X-920 and P-E Model 550. Add 40 lb. shipping. **Customer satisfaction is guaranteed.** Full refund with the return of any product within 10 days. X-9000 CPU \$2995. Pascal MICROENGINE™ owners manual \$19.95; X-920 operators manual \$10, postpaid. **Cash prices.** 10% down guarantees priority. IL residents add 5% sales tax. **Master Charge and Visa** accepted.

Computex stands for competence. We **service what we sell.** Written hardware warranty. Nationwide service contracts. Custom software. We provide **expert technical support.**

(312) 684-3183
COMPUTEX
 Microcomputer Systems
 "The Computer Experts"
 5710 Drexel Avenue
 Chicago, IL 60637

First Nybble	0	1	2	3	4	5	6	7	8	9	A	B	C	D	E	F
0																
1		LD IY,nn						LD (IY+d),B							POP IY	
2		LD (nn),IY						LD (IY+d),C								
3		INC IY						LD (IY+d),D							EX (SP),IY	
4								LD (IY+d),E								
5								LD (IY+d),H							PUSH IY	
6								LD (IY+d),L								
7								LD (IY+d),A								
8									ADD A,(IY+d)							
9	ADD IY,DE	ADD IY,SP								SUB (IY+d)	AND (IY+d)	OR (IY+d)				
A																
B																
C																
D																
E																
F																

Table 6: Indexed instructions employing the IY register. Note the similarity with table 4. These operation codes begin with the FD prefix.

Second Nybble	0	1	2	3	4	5	6	7	8	9	A	B	C	D	E	F
0																
1																
2																
3																
4																
5																
6	RLC (IY+d)	RL (IY+d)	SLA (IY+d)	BIT 0, (IY+d)	BIT 1, (IY+d)	BIT 2, (IY+d)	BIT 4, (IY+d)	BIT 6, (IY+d)	RES 0, (IY+d)	RES 2, (IY+d)	RES 4, (IY+d)	RES 6, (IY+d)	SET 0, (IY+d)	SET 2, (IY+d)	SET 4, (IY+d)	SET 6, (IY+d)
7																
8																
9																
A																
B																
C																
D																
E	RRC (IY+d)	RR (IY+d)	SRA (IY+d)	SRL (IY+d)	BIT 1, (IY+d)	BIT 3, (IY+d)	BIT 5, (IY+d)	BIT 7, (IY+d)	RES 1, (IY+d)	RES 3, (IY+d)	RES 5, (IY+d)	RES 7, (IY+d)	SET 1, (IY+d)	SET 3, (IY+d)	SET 5, (IY+d)	SET 7, (IY+d)
F																

Second Nybble

Table 7: Indexed instructions of the FDCB class, again employing the IY register. Note the similarity with table 5.

RAYGAMCO

JOIN NOW!



BIG SAVINGS ON EVERY ITEM!

Become a member of
RAYGAMCO
Computer Discount Club.

By being a RAYGAMCO Member you receive substantial discounts on every item you purchase, including all hardware, software, accessories, even books and paper! You will also receive a monthly newsletter with all the latest available for your particular computer system, and much, much more — exclusive to RAYGAMCO Members only!

Here's how to join. Fill out the information and mail. That's all there is to it. I want to be a RAYGAMCO Computer Discount Club Member. Please send my RAYGAMCO Membership card to:

Name _____
 Address _____
 City _____ State _____ Zip _____
 Computer (Brand Name) _____
 I would like information on (please specify system, part, accessory, book, program, etc.) _____

TOLL FREE, EXCEPT CA

Store Hours: 800-854-6455
 Sat 10-6, Sun 12-4, Tu-Fri 11-8

RAYGAM, INC.
 6791 WESTMINSTER AVENUE
 WESTMINSTER, CA 92683
 TELEX 182274 (714) 891-2587

Text continued from page 200:

Finally, place after this code group a displacement suffix, d.

The Z80 also has a second index register, which is designated the IY register. Op codes which use it for addressing are contained in tables 6 and 7. It takes only a quick glance to notice the strong similarity between tables 4 and 6 and between tables 5 and 7. As might be expected, virtually everything said previously about the IX class of op codes also refers to the IY class. The sole exception to this statement is that the IY-type instructions begin with hexadecimal code FD, instead of DD.

Miscellaneous Additions

All fifty-six instructions in the last of the four expansion sets begin with hexadecimal code ED. They are listed in table 8. Though they are quite heterogeneous, they add considerably to the power of the Z80. Among these, for example, are instructions that enhance the 16-bit arithmetic capability, set interrupt modes, permit complementing the accumulator, and allow a register-indirect type of I/O to be performed. There are instructions also, which allow counting or block processing to be done during loading, comparison, and I/O operations. Even if the other three expansion sets were omitted, the instructions in this set would be highly useful additions to the basic 8080 complement.

With such a hodgepodge of function, it is rather surprising that any order at all can be made of these ED class instructions. Nonetheless, consistency with the other tables is maintained. It is evident from the arithmetic and the leftmost I/O instructions that arrangement by order of first and second operands is used whenever possible. Separation of complementary functions by eight rows in a column is also followed.

There are 696 valid op codes in the seven Z80 tables. Without organizational consistency, conversion of these instructions from mnemonic to hexadecimal form would be extremely difficult and probably ridden with error. Fortunately, these codes are very well arranged, following the pattern established for the 8080. It takes a little practice to become adept at making these transformations, but with the aid of these tables it can be accomplished successfully. ■

Now Build Professional Quality Printed Circuit Boards INSTANTLY With E-Z CIRCUIT™

by Bishop Graphics, Inc.

PRESSURE-SENSITIVE COPPER Design Products

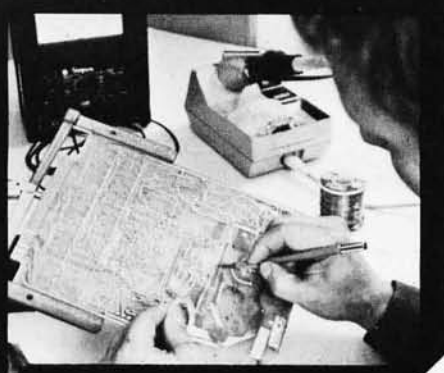

With E-Z CIRCUIT's revolutionary new pressure-sensitive Copper Design Products, you actually build "instant" professional caliber PC boards right in your own shop or home, WITHOUT chemicals, artwork, photography, screening or etching.

The exclusive new E-Z CIRCUIT Copper Design System contains everything you need to produce or repair a professional, printed circuit board with electrical and mechanical characteristics that simulate those of etched "production house" PC boards. Our unique Technical Manual, with easy-to-follow, illustrated "how to" tips and

techniques shows and tells you how.

E-Z CIRCUIT's pressure-sensitive copper products are only one dimension of the E-Z CIRCUIT family. The comprehensive E-Z CIRCUIT Technical Manual & Catalog 102 contains detailed information on the entire product line, including:

- PC Drafting Aids to help you create professional PC board artwork
- General Purpose PC Plug Boards, DIP & SIP Sockets, Terminal Pins, Wire and Accessories for building PC boards with today's fast, modern wire wrapping methods

E-Z CIRCUIT™
by Bishop Graphics, Inc.

5388 Sterling Center Drive • P.O. Box 5007
Westlake Village, CA 91359 U.S.A.
(213) 991-2600 • Telex: 66-2400



For your copy of this value-packed E-Z CIRCUIT Technical Manual & Catalog 102, including information on the location of your nearest E-Z CIRCUIT Distributor, send \$1.00 — plus 50¢ for postage and handling — along with your name and address to:

ANOTHER FIRST FROM MOUNTAIN HARDWARE. SUPERTALKER.

FOR YOUR APPLE

SuperTalker is a peripheral system which permits the output of exceptionally high quality human speech through a loudspeaker under program control. Initially, words, sentences or phrases are digitized into RAM memory through a microphone. Speech data in RAM may be then manipulated like any other data. The system consists of a peripheral card, microphone, loudspeaker, and operating software. \$279 assembled and tested.



Available through Apple dealers worldwide.

Mountain Hardware, Inc.

LEADERSHIP IN COMPUTER PERIPHERALS

300 Harvey West Blvd.

Santa Cruz, CA 95060 (408) 429-8600



Desk Top Wonders

The Periodic Chart at Your Fingertips Using the TI-59

Bruce D Marquardt, 1831 18th St Apt 44,
National City CA 92050

Innovative ideas that use hand-held programmable calculators are penetrating into the business and scientific communities. Concepts and ideas that previously could be tested only by large computers can today be performed in the palm of your hand.

Because of my interest in programmable calculators, I am always looking for a challenge. While I was attending a chemistry lecture, a question presented itself to me: What is a chemist without a periodic chart? [Editor's Note: *I have no retort. . . .* RSS]

Text continued on page 210

Listing 1: Keystrokes for the periodic-table program. The TI-59 should be configured for 319 program steps and 79 data registers, and the program will require two magnetic cards for storage. When running the program, the user can recover from an error condition by pressing CLR and beginning again.

000	76	LBL	075	32	X:T	150	00	00
001	10	E'	076	00	0	151	72	ST*
002	32	X:T	077	77	GE	152	02	02
003	86	STF	078	00	00	153	48	EXC
004	03	03	079	92	92	154	00	00
005	87	IFF	080	01	1	155	65	X
006	01	01	081	00	0	156	43	RCL
007	02	02	082	06	6	157	04	04
008	65	65	083	22	INV	158	95	=
009	22	INV	084	77	GE	159	44	SUM
010	86	STF	085	00	00	160	05	05
011	03	03	086	92	92	161	99	PRT
012	86	STF	087	87	IFF	162	91	R/S
013	01	01	088	02	02	163	22	INV
014	86	STF	089	00	00	164	87	IFF
015	02	02	090	96	96	165	02	02
016	01	1	091	92	RTN	166	00	00
017	69	DP	092	02	2	167	92	92
018	17	17	093	94	+/-	168	22	INV
019	47	CM8	094	34	FX	169	86	STF
020	08	8	095	91	R/S	170	01	01
021	69	DP	096	43	RCL	171	92	RTN
022	17	17	097	06	06	172	76	LBL
023	01	1	098	55	+	173	17	B'
024	42	STD	099	02	2	174	87	IFF
025	04	04	100	85	+	175	02	02
026	32	X:T	101	93	.	176	00	00
027	91	R/S	102	05	5	177	92	92
028	76	LBL	103	95	=	178	29	CP
029	11	A	104	42	STD	179	22	INV
030	71	SBR	105	01	01	180	67	EQ
031	01	01	106	59	INT	181	01	01
032	63	63	107	42	STD	182	88	88
033	29	CP	108	02	02	183	43	RCL
034	67	EQ	109	32	X:T	184	07	07
035	00	00	110	43	RCL	185	61	GTD
036	40	40	111	01	01	186	02	02
037	42	STD	112	22	INV	187	18	18
038	04	04	113	67	EQ	188	55	+
039	91	R/S	114	01	01	189	01	1
040	43	RCL	115	19	19	190	52	EE
041	04	04	116	02	2	191	03	3
042	91	R/S	117	42	STD	192	95	=
043	76	LBL	118	03	03	193	42	STD
044	12	B	119	01	1	194	00	00
045	71	SBR	120	09	9	195	01	1
046	01	01	121	44	SUM	196	52	EE
047	63	63	122	02	02	197	06	6
048	29	CP	123	73	RC*	198	22	INV
049	67	EQ	124	02	02	199	64	PD*
050	00	00	125	42	STD	200	01	01
051	55	55	126	00	00	201	43	RCL
052	42	STD	127	01	1	202	00	00
053	06	06	128	52	EE	203	74	SM*
054	91	R/S	129	06	6	204	01	01
055	43	RCL	130	64	PD*	205	69	DP
056	06	06	131	02	02	206	21	21
057	91	R/S	132	73	RC*	207	93	.
058	76	LBL	133	02	02	208	05	5
059	13	C	134	59	INT	209	22	INV
060	71	SBR	135	22	INV	210	44	SUM
061	01	01	136	74	SM*	211	01	01
062	63	63	137	02	02	212	69	DP
063	43	RCL	138	55	+	213	27	27
064	05	05	139	01	1	214	43	RCL
065	99	PRT	140	52	EE	215	07	07
066	98	ADV	141	03	3	216	22	INV
067	91	R/S	142	95	=	217	52	EE
068	76	LBL	143	22	INV	218	91	R/S
069	15	E	144	52	EE	219	61	GTD
070	71	SBR	145	97	DSZ	220	01	01
071	01	01	146	03	03	221	88	88
072	63	63	147	01	01	222	76	LBL
073	43	RCL	148	27	27	223	16	A'
074	06	06	149	48	EXC	224	42	STD

POCKET ASCII TERMINAL

MIDGET
DUPLEX UNIT
WITH MAN-SIZED
CAPABILITIES

Here's \$395 worth of convenience for anyone working with digital systems. Carry it anywhere in a pocket, valise or toolkit to enter and retrieve data, run diagnostics, change constants, test data links, etc.

Look at its facilities:

- Transmits 128 ASCII codes
- Can display last 30 characters received
- Displays full 64-character ASCII set on clear 16-segment LEDs
- 25-line RS232/c compatible interface
- Single 5V supply required at 400mA typical
- 110 or 300 baud transmission selectable
- Parity codes, stop bits settable to your standard
- Obeys bell, cursor and data format control codes

Phone or write us for more details now:

GR ELECTRONICS,
1640 Fifth Street,
Santa Monica, CA 90401.
Telephone: (213) 395-4774.
Telex: 65-2337 (BT Smedley SNM).



FOR THE VERY BEST IN NORTHSTAR® COMPATIBLE SOFTWARE

DATA BASE MANAGERS SPECIALII \$10.00 OFF of Selector-III C2

SELECTOR-III C2: SuperSoft is proud to offer the Selector-III C2 at a special \$10.00 discount. Selector III allows instant recall of any record using any information item in the record. This makes Selector-III the most powerful Data Base Management System in micro-computers today! You can define a data format and begin entering your data in minutes. Helps bring applications on line in hours instead of months. (Note: Selector-III C2 requires CP/M and C BASIC-2, not supplied - also 48K Ram required for some applications) Selector-III C2 is: \$335.00 (\$10.00 off list!). (Manual alone: \$20.00)

INSURANCE AGENTS

CRS - Client Record System. A complete program package for the Insurance agent. CRS will provide you with very fast online access to your client records, print reports and mail labels, and give you all the information you will need to increase your sales through the use of CRS as a MARKETING TOOL.

CRS stores a complete record for each client that includes the name, address, telephone #, as well as provisions for customer #, salesman # and up to six policies (expandable, if needed). Write for details.

CRS comes with two(2) user's manuals, one for the owner, and one for office personnel (minimal system: one drive, 40K RAM starting 2000H) \$250.00 (Manual: \$40.00)

TEXT PROCESSORS

TFS - Text Formatting System. At last a full featured text processor for NorthStar that you can rely on! TFS has left & right margin justification, page numbering, chaptering, page headings, centering, paged output & MORE. Supports powerful text manipulation including: global & local 'search and change,' file merges and block moves. This means that you can restructure your text file at any time to look the way you want it to, you can even 'chain' files together from disk for documents larger than your current memory.

TFS is completely 'load and go' therefore you can start using it at once. You get two(2) user's manual: one is a Quick Start manual to get you going in minutes, the other is an in depth study of TFS. (TFS requires RAM from 0000H to 2000H) \$75.00 (Manual only: \$20.00)

SPEECH SYNTHESIZER SOFTWARE

'ANGLOPHONE' - Lets any 8080/286 computer convert ordinary English into phonetic codes to drive Votrax, computalker, and TRS-80 Voice synthesizes. This is a hardworking, tested program suitable for use in the most demanding situations. (Details below). Inquire for specific prices and media.

COMPUTER AIDED INSTRUCTION

M I S S - Microcomputer Instructional Support System. A complete, self-contained CAI package applicable to home, school or business education. Includes everything needed to create a sophisticated computer learning environment. MISS allows one to create any type lesson complete with wrong answer branching, re-test, and complete record keeping. The student is prompted 100% of the way and need have no special knowledge. A special feature is the optional use of a unique algorithm which separates spelling errors from incorrect responses. Absolutely no programming knowledge is required. MISS is completely interactive and maintains complete records on any number of students and lessons (limited only by disk space). MISS is a completely flexible system that will allow you to either create lessons or to purchase pre-programmed lessons which run under MISS. Complete with user's manual....\$40.00 (Manual alone: \$10.00)

ASSEMBLERS

ARIAN - A complete 8080 assembler that interfaces directly to your DOS. ARIAN is completely 'load and go'. Features include: dynamic file and RAM allocation, custom disk and RAM command capability, several library routines directly accessible by the user. Also, a complete text editor, and system executive. ARIAN is both powerful and easy to learn and use; it is an assembler that you can grow with. Comes complete with a 51 page user's manual (ARIAN requires RAM from 0000H to 2000H) \$50.00 (Manual alone: \$10.00)

ARIAN Utility Package - Several disk based utilities. Includes a complete DEBUG Package: \$50.00

PROGRAMMING LANGUAGES

'Tiny' Pascal - This is famous Chung/Yuen 'tiny' Pascal. FAST - ELEGANT - STRUCTURED. Local and global variables plus procedure and function independence make 'tiny' Pascal great for high speed applications. Compiles to 8080 code that executes up to 25 times faster than BASIC. You also receive SOURCE to 'tiny' Pascal written in Pascal. This means that you can compile the compiler! Add features, relocate, etc. (you will need 36K to do this) \$40.00

UTILITIES

D E B E - (Does Everything But Eat!) This is a must for NorthStar users. You can: COMPACT & EXPAND BASIC programs. Compacting removes unnecessary spaces and remarks. This saves money and makes programs run faster. Expanding puts them back again.

Cross-reference BASIC programs by variables and transfer statements.

Global substitutions of variables and transfer statements.
Formatted print outs of BASIC programs as well. \$40.00

SPECIFY SINGLE OR DOUBLE DENSITY

TRS-80 COMPATIBLE SOFTWARE

'Tiny' Pascal FOR TRS-80

Now you too can have Pascal! The famous Chung/Yuen 'tiny' Pascal has been specially designed for the TRS-80! The full power and elegance of 'tiny' Pascal is at your command. Programs written in 'tiny' Pascal run at least 4 times faster than the same program in BASIC! 'tiny' Pascal is also a great way to learn Pascal programming, & fun too.

Best of all, you only need a 16K Level II TRS-80! No disk is required. The 'tiny' Pascal operating system is self-contained and very easy to use.

'Tiny' Pascal is a subset of standard Pascal & includes: RECURSIVE PROCEDURE/FUNCTION, IF THEN ELSE REPEAT/UNTIL, 'PEEK' & 'POKE', WHILE DO, CASE, MORE! (Plus full graphics for your TRS-80).

You can save and load programs to and from tape in both source or compiler form.

You get all this and more, plus a user's manual for \$40.00.

SPEECH SYNTHESIZER SOFTWARE

'ANGLOPHONE': At last you can take complete advantage of your TRS-80 voice synthesizer. Forget about cumbersome phonetic codes. With 'Anglophone' you can simply use ordinary English. Completely interfaces with BASIC, or just about any other programming language. 'Anglophone' applies sophisticated pronunciation rules to transform normal English spelling into speech using the TRS-80 Voice Synthesizer. Minimum hardware: Level II, 16K, Voice Synthesizer. Comes complete with user's manual and test program.\$45.00

Energy-Miser

Energy-Miser is a complete heating/cooling analysis program for your home, office or business! With Energy-Miser you can calculate heat loss because of poor insulation, leaky doors and windows, poor planning and more. With Energy-Miser you can predict the annual savings on your utility bills for various improvements or modifications, including: use of solar power, better insulation, opening and closing drapery, etc.

But there is even more: Energy-Miser can also calculate your Return on Investment. That is, you can find your break point for converting to solar, for insulating better, etc. Energy-Miser even takes into consideration the Energy Tax Credit! Energy-Miser is a program designed to save your money!

Energy-Miser is a proven program written by a professional and includes a complete user's manual for \$22.50. (Minimum System 16K Level II, No Disk Required)

'TALKING TERMINAL': The 'Talking Terminal' program turns a TRS-80 into a talking computer terminal. The 'Talking Terminal' program receives input from a remote computer and converts it to spoken words. Its many user options include: Instant Replay, spelled speech, silent or pronounced punctuation, and more. Minimum hardware: Level II, 16K, Voice Synthesizer, RS-232C board and expansion interface.\$145.00



ALL ORDERS PREPAID OR C.O.D.
ILLINOIS RESIDENTS ADD 5% SALES TAX
(217) 344-7596

SUPERSOFT
P.O. Box 1628
Champaign, IL 61820

```

225 07 07 | 244 85 + | 263 07 07
226 22 INV | 245 02 2 | 264 91 R/S
227 87 IFF | 246 00 0 | 265 43 RCL
228 01 01 | 247 95 = | 266 07 07
229 00 00 | 248 42 STD | 267 32 X:T
230 92 92 | 249 01 01 | 268 42 STD
231 22 INV | 250 59 INT | 269 08 08
232 86 STF | 251 32 X:T | 270 25 CLR
233 02 02 | 252 43 RCL | 271 22 INV
234 71 SBR | 253 01 01 | 272 67 EQ
235 00 00 | 254 22 INV | 273 02 02
236 75 75 | 255 67 EQ | 274 37 37
237 43 RCL | 256 00 00 | 275 43 RCL
238 07 07 | 257 92 92 | 276 08 08
239 75 - | 258 87 IFF | 277 32 X:T
240 01 1 | 259 03 03 | 278 61 GTD
241 95 = | 260 02 02 | 279 00 00
242 55 + | 261 75 75 | 280 09 09
243 02 2 | 262 43 RCL
    
```

(a)	A'	B'	C'	D'	E'
	A	B	C	D	E

Atomic Weights			
Load Atomic Number	Load Atomic Weight		Initialize
N (Occurrence of an Atom)	Atomic Number	Sum of Weights	Run

Figure 1: Placement and definition of user-defined keys. Given the placement of the user-defined keys in figure 1a, the program tape in figure 1b shows the meaning of each key. For example, user-defined key A is used when entering the value for N. See tables 1 and 2, which describe the usage of these keys.

Table 1: Loading and changing atomic weight information. The first routine allows the user to enter the atomic weight for all elements, starting with element 1 and continuing through element 106. The second routine allows the user to make changes to a group of consecutive elements. Since two atomic weights are stored in a single register, both weights for an odd-even pair must be entered even if only one of the two is to be changed. Pressing the R/S button causes the calculator to request the next odd-even pair of atomic weights. The E' key, used to end this loop, can be pressed only when the atomic number showing in the display is odd.

Steps	Procedure	Press	Display
1.	To load atomic weight Initialize.	E'	does not change
2.	Enter 1.	A'	1
3.	Enter atomic weight for atomic number 1.	B'	2
4.	Enter atomic weight for atomic number 2.	R/S	3
	.	.	.
	.	.	.
	.	.	.
5.	Enter atomic weight for atomic number 106. Initialize.	R/S E'	107 does not change
6.	Load data into banks 2, 3, and 4. (Refer to owner's manual for TI Programmable 58/59.) (The program is now complete. The load subroutines will not be needed unless a change of data is required at a later date.)		
7.	To change atomic weight data Initialize.	E'	does not change
8.	Enter n, where n = 1, 3, 5, . . . 103, 105.	A'	n
9.	Enter atomic weight for n.	B'	n + 1
10.	Enter atomic weight for n + 1. (n + 1 is even)	R/S	n + 2
	.	.	.
	.	.	.
	.	.	.
11.	If the number displayed is odd, press E' to exit the "change atomic weight data" routine.	E'	does not change
12.	To recall atomic number for the next atomic weight to be entered. (Step 12 is performed when the operator initializes with n, an even integer, thereby initiating an error condition.)	CLR, B'	Atomic number
13.	Repeat steps 9, 10, and 11 to continue.		

Table 2: Retrieval of data from the program. The first routine finds an element's atomic weight, given its atomic number. The second routine calculates the molecular weight of a molecule given a set of quantity/atomic-number pairs that describe the molecule. The quantities marked with asterisks (*) denote numbers that will be printed when a PC-100A or PC-100C printer is attached.

Steps	Procedure	Press	Display
1.	To find atomic weight Initialize. (When program is initialized, the display is preserved.)	E'	does not change
2.	Enter atomic number.	B,E	value of atomic weight*
3.	Repeat step 2 for new atomic number.		
4.	To find molecular weight Initialize.	E'	does not change
5.	Enter atomic number.	B	does not change
6.	Enter how many of that particular element.	A,E	A × atomic weight*
7.	Repeat steps 5 and 6 for each element.		
8.	Calculate total weight (sum weight.)	C	total weight of mole- cule*
9.	(Note: label C is a subtotal.) To find weight of a new formula, go to step 4.		
10.	Recall last A entry (when desired)	CLR, A	Last A
11.	Recall last B entry (when desired) (Steps 10 and 11 are merely for conven- ience and do not interfere with program flow.)	CLR, B	Last B

Table 3: Table showing usage of registers 00 thru 79 in the periodic-table program, listing 1. The atomic weights must be in the form of XXX.XXX; leading and trailing zeros will be automatically inserted.

Register Number	Use
00 thru 09	Used.
10 thru 19	These registers are left open to allow the operator to store additional data during program use without altering internal program executions.
20 thru 72	Used to store atomic weights.
73 thru 79	Not used.

Text continued from page 208:

I realized that a programmable calculator could easily be used to store and retrieve data contained in the periodic chart; once this is done, the user can manipulate periodic-chart data with a small chance of error. Using the Texas Instruments TI-59, I developed the program shown in listing 1.

This program, documented in tables 1 and 2, contains two types of routines, the first for loading atomic weights, and the second for retrieving them. I decided to

sacrifice speed of execution for ease of operation and protection of loaded data.

This program will enable you to:

- Display atomic weights by entering the corresponding atomic numbers.
- Calculate molecular weights.
- Calculate any combination of atomic weights.
- Load atomic weights either sequentially or randomly.
- Print values using the PC-100A or PC-100C printers. ■

VULCAN = DBMS

THE PROFESSIONAL and PERSONAL DATABASE MANAGEMENT SYSTEM

For 8080/Z80 systems under CP/M or PTDOS

- **VULCAN** is a complete database management system that has 38 powerful, easy to learn, English-like commands to manipulate files, records, fields, and scratch-pad variables.
- **VULCAN** has a command repertoire which includes such commands as: SORT, REPORT, APPEND, INSERT, EDIT, COPY, REPLACE, LOCATE, DISPLAY, DO, LIST, and LOOP.
- **VULCAN JR.** is an interactive inquiry/response system VULCAN can be used in interactive or program mode. The program mode uses modern structured command programs to combine powerful DBMS operations.
- **VULCAN** is written in assembly language for efficient information processing and requires 36K bytes CP/M system and one or more disk drives.
- **VULCAN** can accept or store data in standard ASCII files to be compatible with BASIC, FORTRAN, word processors, etc.
- **VULCAN** can be used for mail lists, inventory, accounting systems, parts lists, etc. It puts you in fingertip control of your data. With VULCAN, you don't need to write a program to do something out of the ordinary.

- **VULCAN (CP/M or PTDOS)** \$490
- **VULCAN JR. (CP/M only)** \$ 98
- Manual only \$ 25

SCDP

Software Consultation Design and Production

6542 Greeley St.

Tujunga, CA 91042 (213) 352-7701

California residents add 6% sales tax.

The "Blue Box"

IDS MODEL 60 MODEM AND TERMINAL INTERFACE POCKET ANALYZER



Our Model 60 is called "The Blue Box" by thousands of users. This compact unit packs the most testing capability per dollar. Pinpoints the source of trouble between the Modem and Terminal. Provides access to all 25 lines of the EIA RS 232 interface. Has 12 monitoring LED's plus two

voltage-sensing LED's. 24 miniature switches allow isolated testing and observation of all signals. Mini-jumpers included for cross-patching and signal monitoring. Sturdy 10 oz. unit has hard plastic case, is battery powered, regular or rechargeable. Immediate delivery.

INTERNATIONAL DATA SCIENCES, INC.

7 Wellington Rd., Lincoln, R.I. 02865 • Tel: (401) 333-6200 • TWX: (710) 384-1911
Export: EMEC, 2350 S. 30th Ave., Hallandale, Florida 33009

EXCITING MAIL ORDER DISCOUNTS

apple computer II
16K
\$959

APPLE II 32K '1050
APPLE II 48K '1100

• COLOR • GRAPHICS • SOUND

APPLE II ACCESSORIES

CORVUS 10 MEGABYTE DISK DRIVE . . . \$4650**	CLOCK/CALENDAR CARD \$170**
PASCAL LANGUAGE SYSTEM 445**	INTROL X-10 SYSTEM 240**
GRAPHICS INPUT TABLET 875**	SUPERTALKER SPEECH SYNTHESIZER . . 240**
DISK II with CONTROLLER CARD 495**	ROMPLUS CARD 150**
DISK II without controller 440**	HUERISTICS SPEECHLINK 2000 225**
APPLESOFT FIRMWARE CARD 155**	DC HAYES MICROMODEM II 335**
INTEGER FIRMWARE CARD 155**	ALF MUSIC SYNTHESIZER 245**
PARALLEL INTERFACE CARD 155**	SSM AIO CARD (KIT) 125**
SERIAL INTERFACE CARD 160**	SSM AIO CARD (A&T) 190**
COMMUNICATIONS CARD 190**	NOVATION CAT MODE M 169**

PRINTERS

ANADEX DP 8000	\$785.00
CENTRONICS 730-1	795.00
AXIOM EX-801	495.00
AXIOM EX-820	795.00
TRENDCOM 100	335.00

SD EXPANDORAM

• 64K S-100 DYNAMIC RAM BOARD	WITHOUT MEMORY \$135.00
• WORKS WITH Z-80, 8080 & 8085	16K KIT 199.00
• POWER CONSUMPTION 5 WATTS	32K KIT 259.00
• BANK SELECT • PHANTOM REFRESH	48K KIT 329.00
• NO WAIT STATES REQUIRED	64K KIT \$389.00

ADD \$50 FOR ASSEMBLED & TESTED

THE AMAZING SORCERER™ by **\$995.00**

The SORCERER is a Z80 CPU based micro-computer internally expandable to 48K. 4K ROM resident monitor. I/O connector for S-100 expansion. Parallel and serial interface. Dual cassette I/O. Graphic resolution of 240 x 512, 30 lines of 64 characters, 8 x 8 dot matrix. Full ASCII set (upper and lower case), plus standard graphic symbols. User may define up to 128 characters. Keyboard is 63-key data processing type, plus a 16 key numeric input pad.

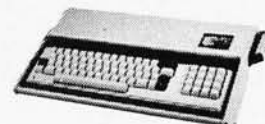

32K 1,145.00 48K 1,295.00

LEEDEX VIDEO 100

- 12" BLACK & WHITE MONITOR
- VIDEO BANDWIDTH 12 MHz ± 3db
- COMPOSITE VIDEO INPUT

\$129.00



SOROC IQ 120

- SERIAL RS232C
 - FULL ASCII UPPER/LOWER CASE
 - NUMERIC KEYPAD CURSER KEYS
 - SCREEN CONTROL & PROTECTED FIELDS
- \$775**



• ALSO AVAILABLE •

SOROC IQ 140 \$1,225.00

• TO ORDER •

Phone orders invited, using credit cards. Or send cashiers check or money order that draws on a U.S. bank. Please add 2% (\$5.00 Minimum) for handling, shipping (air service) and insurance, or equipment will be shipped freight collect. California residents add 6% sales tax. All equipment is in factory cartons with the manufacturers warranty. Equipment is subject to price change and availability without notice.



COMPUTER SPECIALTIES

6363 EL CAJON BLVD., SUITE 205,
SAN DIEGO, CA. 92115 • (714) 579-0330

KIM-1 Multiplication and Division

James C Couchman, General Dynamics Corp, Fort Worth
Division, POB 748, Fort Worth TX 76101

When I bought a MOS Technology KIM-1 microcomputer to use in a specific control function, it arrived with a set of comprehensive instruction, programming, and hardware books. As soon as I connected a 5 V power supply, I was able to interact with the machine through the hexadecimal keyboard and light-emitting diode (LED) display. It was a bit more difficult to get our Teletype to work with the KIM-1, but with a slight adjustment to the teleprinter timing, the problem was cured.

The KIM-1 is still a real bargain, with features including the 6502 microprocessor, 2 K bytes of read-only memory (containing the Keyboard Input Monitor from which the name is derived), an interval timer, fifteen input and output lines, 1 K bytes of programmable memory (with address logic for 16 K bytes), and probably some features I have not yet discovered.

Since the KIM-1 is programmed in machine language using a set of fifty-six instructions, I believe that the best way to learn to program it is to not just read about it, but do it. One should just start writing code, and, in time, the power of the basic instruction set will really be understood and appreciated.

Once the user is familiar with the capabilities of the KIM-1, he begins to wish that it could do more. One tool that provides more capability is a set of software routines that perform sixteen-bit multiplication and division on the 6502 processor. After I searched for a suitable set of routines, I concluded that I would have to write my own.

To prevent you from having to "reinvent the wheel," I am presenting these routines here. In developing these routines, I enlisted the invaluable assistance of my associates G R Arnett and J R Williamson. These routines should work without much difficulty on other 6502-based computers.

Sixteen-Bit Routines

These routines can multiply and divide two 16-bit signed quantities together and produce a signed 16-bit result. The routines are written as relocatable sub-routines.

In multiplication, the high-order byte of the first multiplicand is loaded into hexadecimal location 0000, and the low-order byte into location 0001. The high-

order byte of the second multiplicand is put into location 0006, and the low-order byte into location 0007.

In division, the high-order byte of the divisor is loaded into hexadecimal location 0000; the low-order byte into location 0001. The high-order byte of the dividend is placed into location 0006, and the low-order byte is loaded into location 0007. If the value of the divisor is zero, the division routine will return control to the calling program.

For both the multiplication and the division routines, the answer is returned in hexadecimal locations 0002 (high-order) and 0003 (low-order byte). It should not be very hard to change this if need be.

An example of a simple calling routine is shown in listing 1. The calling sequence is essentially the same for both multiplication and for division; only the value contained in the two bytes that follow the jump-to-subroutine (JSR) instruction must be changed.

Listing 1a: Calling sequence for 16-bit multiply subroutine.

Address	Code
0007	20 (JSR)
0008	00
0009	01 (multiply)
000A	A9 (LDA)
000B	00
000C	F0
000D	FC

Listing 1b: Calling sequence for 16-bit divide subroutine.

Address	Code
0007	20 (JSR)
0008	30
0009	00 (divide)
000A	A9 (LDA)
000B	00
000C	F0
000D	FC

MAGSAM T.M.

KEYED FILE MANAGEMENT SYSTEMS for CBASIC and Micropolis BASIC

Developing business applications in BASIC?

Then you have felt the need to create, retrieve, and update your data by user defined keys. MAGSAM provides this plus much more...

- Random, sequential, and generic access by key
- Secondary indexing with any number of keys
- Key and record deletes with automatic space reclamation
- Dynamic file allocation and extension
- Complete compatibility with BASIC files
- Easy to use — initiated through simple BASIC statements

In use world wide, MAGSAM is now better than ever!

New! MAGSAM IV™ for CP/M and CBASIC — High performance 8080 assembler version of the highly acclaimed MAGSAM III. Same powerful features with up to 60% faster access time. Ideal for serious business applications where response time is critical. **\$295/\$25†**

New! MAGSAM III™ for Micropolis — Now Micropolis BASIC users can have all the powerful features and capabilities of MAGSAM III. Save development time while providing more sophisticated applications. Perfect for all business applications. **\$145/\$15†**

Improved! MAGSAM III™ for CP/M and CBASIC — MAGSAM III Release 4.0 provides all standard MAGSAM features plus — increased performance; enhanced tutorial program and file utilities; improved data integrity; plus a new memory-saving read-only module. **\$145/\$15†**

Visa and Mastercharge welcome. Dealer and OEM inquiries invited.

† MAGSAM package price/manual only price. Single CPU license. MAGSAM package includes MAGSAM file manager, tutorial program, file dump utility, read-only module (MAGSAM III only), User Guide, Reference Card, and one year update service. CBASIC versions require CBASIC and CP/M-compatible DOS. MAGSAM III distributed as BASIC source. MAGSAM IV distributed in object form. CBASIC versions available on 8" and Micropolis Mod II disks. Micropolis version available on Mod II disk.

• Registered trademark of Digital Research



MICRO APPLICATIONS GROUP
7300 CALDUS AVENUE
VAN NUYS, CA 91406

Your Full Service Computer Store

We Have It All!



- **HARDWARE**
- **SOFTWARE**
- **PERIPHERALS**
- **ACCESSORIES**
- **SEMINARS**
- **BOOKS, MANUALS, MAGAZINES**
- **DISK DRIVES**
- **PRINTERS**
- **MONITORS**
- **FURNITURE**

All the famous brand names, including:

- | | | |
|--------------------------|---------------------|------------------|
| APPLE | Alpha Micro | Soroc |
| ATARI | Alpha Pro | Hazeltine |
| EXIDY/Sorcerer | Cromemco | Sektor |
| Kim/Commodore | Xerox | PET |
| Texas Instruments | Lear Siegler | Shugart |

VISA • BankAmericard • Master Charge

ComputerWorld

- | | | |
|--------------------|---------------------|----------------|
| WESTMINSTER | — 6791 Westminster | (714) 891-2584 |
| IRVINE | — 270 South Bristol | (714) 957-5874 |
| VAN NUYS | — 5848 Sepulveda | (213) 786-7411 |
| LAWDALE | — 15818 Hawthorne | (213) 370-4842 |
| BURBANK | — 3808 West Verdugo | (213) 848-5521 |

CALL ON JOHN D. OWENS FOR ALL OF YOUR COMPUTER NEEDS

HAZELTINE 1500, 1510, 1520

Best prices available.
With 50 Hz. add \$100.
Foreign character sets available.

IBM 3101 CRT \$1,295
9 x 16 dot matrix. Selectric-like keyboard.

WORDSMITH Video subsystem ... \$1,395
S-100, 40 lines, 80 columns, powerful word processor.

SOROC IQ 120 \$865

IMS 16K Memory, 250 ns \$285
4116 RAM Chips \$10
for Superbrain and TRS-80

CALIFORNIA COMPUTER SYSTEMS
16K Memory \$270
Runs in 4MHZ systems with no wait states.

Call on us for product sheets. Dealer inquiries invited. Prices subject to change without notice.

PAPER TIGER \$945
graphics option \$199

TELETYPE MODEL 43 \$985
with RS232 \$1,085

DEC LA 35/36 UPGRADE \$750
Increases baud to 1200
Microprocessor controlled.

NEC Spinwriter 5510 \$3,000
QUME SPRINT 5/55 \$3,195
DIABLO 1640 KSR \$3,380

MODEM: The Cat \$190
Originate/answer

TELETEK, TARBELL SINGLE AND DOUBLE DENSITY CONTROLLERS
KONAN HARD DISK CONTROLLER

TELEVIDEO Smart CRTs
912B \$745
912C \$780
920B \$795
920C \$850

IMS 5000 and 8000 systems
Z80 CPU, S-100, CP/M, dual double density drives, 32K RAM \$2,765

MARINCHIP 9900 16Bit, S-100
Excellent software package includes word processor \$700

DISK DRIVES: SIEMENS \$450
SHUGART \$525
PER SCI 277 \$1,210
INNOTRONICS \$522

TEI MAINFRAME 12 slots \$460
22 slots \$609

Telebuffer 43ASR \$945
Enables the TTY43 to function as a Telex without paper tape. Many options.

COD's accepted at no extra charge.
Shipping: \$13 for light printers and CRT's/
Credit cards add 4%

WE EXPORT. OVERSEAS CALLERS USE (212) 448-6298 ONLY or TWX: 710 588 2844 CABLE: OWENS ASSOC.

We have no reader inquiry number. Please call or write. Product sheets available.

JOHN D. OWENS ASSOCIATES, INC.

12 SCHUBERT STREET

STATEN ISLAND, NEW YORK 10305

(212) 448-6283

WE ARE KNOWN FOR OUR PROMPT, COURTEOUS SERVICE

(212) 448-6298

Disc/3 MART, INC.

DO IT YOURSELF

LOW-LOW PRICES

ANADEX Printer, DP 8000	\$ 845.00
CENTRONIX 730 Matrix Printer	825.00
(with 4 free zip pack ribbons)	
HAZELTINE 1520	1319.00
NEC Spinwriter 5510 (RO)	2643.00
<small>(inc. forms tractor)</small>	
SORC IQ 140 (Assembled)	1245.00
TI 810 Basic (upper & lower case)	1669.00
TI 994 Personal Computer	1150.00
TEC 511 CRT (upper & lower case)	799.00
LA 34 DEC Writer Teleprinter	1195.00

CARTRIDGES • DISKETTES • MAG TAPE
ACCESSORIES

ADDS, CENTRONICS, HAZELTINE, IMSAI, LEAR
SIEGLER, TECHTRAN, TI, VECTOR GRAPHICS
AND OTHERS

STORE HOURS: 9 A.M. - 5:30 P.M. Mon. through Fri.
Call or write for quotes or information.

Disc/3 MART, INC.

1840 LINCOLN BLVD.,
SANTA MONICA, CA 90404
(213) 450-5911



the ULTIMATE in CHEAP VIDEO

BOOK & KIT
ONLY \$42.95

Don Lancaster's "Cheap Video" concept allows almost unlimited options, including:

- * Scrolling - Full performance cursor.
- * Line/Character formats of 16/32, 24/80, 32/64.... or almost anything.
- * Graphics - up to 256 X 256 B&W; 96 X 128 COLOR (requires low-cost option modules)
- * Works with 6502, 6800 and other micros.

SPECIAL OFFER: Buy the Kit (upper case alpha-numeric option included) & get the Book at 1/2 price.

RIA ELECTRONICS, DEPT 11-B, 1020 W. WILSHIRE BLVD., OKLAHOMA CITY, OK 73116

I'm Sold, PLEASE RUSH..... SEND FREE CATALOG

TVT-65g Kit & Cheap Video Cookbook - \$42.95 (enclosed)

TVT-65g Kit only (book required for assembly) - \$39.95

name: _____

address: _____

city: _____ state: _____ zip: _____

RIA ELECTRONICS Dept. 3-B, 1020 W. WILSHIRE BLVD., OKLAHOMA CITY, OK 73116

The assembler mnemonics and hexadecimal code for the multiplication subroutine are given in listing 2. The division subroutine is given in similar form in listing 3. The multiplication subroutine is shown in hexadecimal memory-dump form in listing 4; the division code in that form in listing 5.

My colleagues and I hope that these programs will help other KIM-1 users. We know that having had them prepared for us would have saved us much time.

Listing 2: Relocatable subroutine to perform multiplication of 16-bit quantities on the 6502 microprocessor as used in the MOS Technology KIM-1. Both assembler mnemonics and hexadecimal code are given. Entry point is hexadecimal location 0100.

Address	Mnemonic	Hexadecimal Code
0100	CLC	18
0101	CLD	D8
0102	LDA #0	A9 00
0104	TAX	AA
0105	STA 0002	85 02
0107	STA 0003	85 03
0109	LDA 0000	A5 00
010B	BNE	D0 11
010D	LDA 0001	A5 01
010F	BEQ	F0 0C
0111	CMP #1	C9 01
0113	BNE	D0 1D
0115	LDA 0006	A5 06
0117	STA 0002	85 02
0119	LDA 0007	A5 07
011B	STA 0003	85 03
011D	RTS	60
011E	BPL	10 12
0120	INX	E8
0121	LDA 0001	A5 01
0123	CLC	18
0124	EOR FF	49 FF
0126	ADC #1	69 01
0128	STA 0001	85 01
012A	LDA 0000	A5 00
012C	EOR FF	49 FF
012E	ADC #0	69 00
0130	STA 0000	85 00
0132	LDA 0006	A5 06
0134	BNE	D0 26
0136	LDA 0007	A5 07
0138	BEQ	F0 18
013A	CMP #1	C9 01
013C	BNE	D0 32
013E	DEX	CA
013F	BNE	D0 12
0141	LDA 0001	A5 01
0143	CLC	18
0144	EOR FF	49 FF
0146	ADC #1	69 01
0148	STA 0003	85 03
014A	CDA 0000	A5 00
014C	EOR FF	49 FF
014E	ADC #0	69 00
0150	STA 0002	85 02
0152	RTS	60
0153	LDA 0001	A5 01
0155	STA 0003	85 03
0157	LDA 0000	A5 00
0159	STA 0002	85 02
015B	RTS	60
015C	BPL	10 12
015E	INX	E8
015F	LDA 0007	A5 07

Listing 2 continued on page 215

Listing 2 continued:

0161	CLC	18
0162	EOR FF	49 FF
0164	ADC #1	69 01
0166	STA 0007	85 07
0168	LDA 0006	A5 06
016A	EOR FF	49 FF
016C	ADC #0	69 00
016E	STA 0006	85 06
0170	LDA 0000	A5 00
0172	STA 0004	85 04
0174	LDA 0001	A5 01
0176	STA 0005	85 05
0178	LDA 0003	A5 03
017A	CLC	18
017B	ADC 0001	65 01
017D	STA 0003	85 03
017F	LDA 0002	A5 02
0181	ADC 0000	65 00
0183	STA 0002	85 02
0185	SEC	38
0186	LDA 0007	A5 07
0188	SBC #1	E9 01
018A	STA 0007	85 07
018C	LDA 0006	A5 06
018E	SBC #0	E9 00
0190	STA 0006	85 06
0192	CMP #0	C9 00
0194	BNE	D0 E2
0196	LDA 0007	A5 07
0198	CMP #0	C9 00
019A	BNE	D0 DC
019C	DEX	CA
019D	BNE	D0 15
019F	LDA 0002	A5 02
01A1	EOR FF	49 FF
01A3	STA 0002	85 02
01A5	LDA 0003	A5 03
01A7	EOR FF	49 FF
01A9	CLC	18
01AA	ADC #1	69 01
01AC	STA 0003	85 03
01AE	LDA 0002	A5 02
01B0	ADC #0	69 00
01B2	STA 0002	85 02
01B4	RTS	60

Listing 3: Relocatable subroutine to perform division of 16-bit quantities on the 6502 microprocessor of the KIM-1, with assembler mnemonics. Entry point is hexadecimal location 0030.

Address	Mnemonic	Hexadecimal Code
0030	CLC	18
0031	CLD	D8
0032	LDA #0	A9 00
0034	TAX	AA
0035	STA 02	85 02
0037	STA 03	85 03
0039	LDA 00	A5 00
003B	BNE	D0 05
003D	LDA 01	A5 01
003F	BNE	D0 15
0041	RTS	60
0042	BPL	10 12
0044	INX	E8
0045	LDA 01	A5 01
0047	CLC	18
0048	EOR FF	49 FF
004A	ADC #1	69 01
004C	STA 01	85 01
004E	LDA 00	A5 00
0050	EOR FF	49 FF

Listing 3 continued on page 216

CATCH THE S-100 INC. BUS!



	LIST PRICE	OUR SPECIAL CASH PRICE
S.D. SBC-100 Kit	295.00	199.00
Anadex Printer DP8000 w/Tractor U/L Case Serial or Parallel	995.00	850.00
S.D. Z-80 Starter Kit w/PIO	340.00	210.00
Shugart SA400 Bare Drive Dual Density	450.00	295.00
Godbout 8K UNKIT Econoram II	129.00	110.00
Morrow's Thinker Toys Switchboard I/O Assembled and Tested	259.00	221.00

Subject to Available Quantities • Prices Quoted Include Cash Discounts. Shipping & Insurance Extra.

We carry all major lines such as S.D. Systems, Cromemco, IMSAI, Vector Graphic, North Star, Sanyo, ECT, TEI, Godbout, Thinker Toys, Hazeltine, IMC For a special cash price, telephone us.

Bus **S-100, inc.**
 Address **7 White Place**
 Clark, N.J. 07066
 Interface **201-382-1318**

Z_S - SYSTEMS



64K RAM BOARD

The Z_S-SYSTEMS 64K RAM board is designed to operate in any Z80 based microcomputer having S-100 bus. It uses 16K dynamic RAM chips, & features:

- Board select
- Bank select
- Transparent on-board refresh
- 2 or 4MHz operation (w/ no wait state)
- Memory disable

Compatible with Cromemco and M/PM multiuser. Fully assembled, burned in, & tested. Available from stock to 60 days

As low as \$500.00 in quantities of 100

Price of one \$695.00
 PC board only \$59.00
 With 16K RAM \$359.00
 Plus shipping charges

FLOPPY DISK CONTROLLER

Handles with no modification up to:

- * 4 standard 8" drives (Shugart or compatible) or
 - * 3 minidrives 5"
- Run with 2 or 4 MHz CPU



Use CP/M Disk Operating System Using the 1771 LSI controller
 Price of one \$245.00
 PC board only \$35.00

SEND FOR FREE INFORMATION
 6 months warranty on our boards with normal use

Z_S-SYSTEMS
 PO Box 1847, San Diego, CA 92112
 (714) 447-3997

Listing 3 continued:

```

0052   ADC #0           69 00
0054   STA 00          85 00
0056   LDA 06          A5 06
0058   BNE             D0 26
005A   LDA 07          A5 07
005C   BEQ             F0 18
005E   CMP #1         C9 01
0060   BNE             D0 32
0062   DEX             CA
0063   BNE             D0 12
0065   LDA 01          A5 01
0067   CLC             18
0068   EOR FF          49 FF
006A   ADC #1          69 01
006C   STA 03          85 03
006E   LDA 00          A5 00
0070   EOR FF          49 FF
0072   ADC #0           69 00
0074   STA 02          85 02
0076   RTS             60
0077   LDA 01          A5 01
0079   STA 03          85 03
007B   LDA 00          A5 00
007D   STA 02          85 02
007F   RTS             60
0080   BPL             10 12
0082   INX             E8
0083   LDA 07          A5 07
0085   CLC             18
0086   EOR FF          49 FF
0088   ADC #1          69 01
008A   STA 07          85 07
008C   LDA 06          A5 06
008E   EOR FF          49 FF
0090   ADC #0           69 00
0092   STA 06          85 06
0094   LDA 03          A5 03
0096   CLC             18
0097   ADC #1          69 01
0099   STA 03          85 03
009B   LDA 02          A5 02
009D   ADC #0           69 00
009F   STA 02          85 02
00A1   SEC             38
00A2   LDA 01          A5 01
00A4   SBC 07          E5 07
00A6   STA 01          85 01
00A8   LDA 00          A5 00
00AA   SBC 06          E5 06
00AC   STA 00          85 00
00AE   LDA 00          A5 00
00B0   BMI             30 08
00B2   BNE             D0 E0

```

```

00B4   LDA 01          A5 01
00B6   BNE             D0 DC
00B8   BEQ             F0 0D
00BA   SEC             38
00BB   LDA 03          A5 03
00BD   SBC #1          E9 01
00BF   STA 03          85 03
00C1   LDA 02          A5 02
00C3   SBC #0          E9 00
00C5   STA 02          85 02
00C7   DEX             CA
00C8   BNE             D0 15
00CA   LDA 02          A5 02
00CC   EOR FF          49 FF
00CE   STA 02          85 02
00D0   LDA 03          A5 03
00D2   EOR FF          49 FF
00D4   CLC             18
00D5   ADC #1          69 01
00D7   STA 03          85 03
00D9   LDA 02          A5 02
00DB   ADC #0          69 00
00DD   STA 02          85 02
00DF   RTS             60

```

Listing 4: Multiplication subroutine in hexadecimal memory-dump form.

```

; 18010018D8A900AA85028503A500D011A501F00CC901D01DA50685097A
; 18011802A5078503601012E8A5011849FF69018501A50049FF6900081D
; 1801308500A506D026A507F018C901D032CAD012A5011849FF69010A0B
; 1801488503A50049FF6900850260A5018503A5008502601012E8A5088F
; 180160071849FF69018507A50649FF69008506A5008504A5018505081B
; 180178A5031865018503A5026500850238A507E9018507A506E90007C0
; 1801908506C900D0E2A507C900D0DCCAD015A50249FF8502A503490BE6
; 1801A8FF1869018503A5026900850260E9008D0600C900D0D8AD070962
; 0000080008 0

```

Listing 5: Division subroutine in hexadecimal memory-dump form.

```

; 18003018D8A900AA85028503A500D005A501D015601012E8A5011808C7
; 18004849FF69018501A50049FF69008500A506D026A507F018C9010992
; 180060D032CAD012A5011849FF69018503A50049FF6900850260A50A00
; 180078018503A5008502601012E8A5071849FF69018507A50649FF08A4
; 18009069008506A5031869018503A5026900850238A501E50785010735
; 1800A8A500E5068500A5003008D0E0A501D0DCF00D38A503E901850B00
; 1800C003A502E9008502CAD015A50249FF8502A50349FF186901850A0E
; 1800D803A5026900850260002A3F3C3B3F1E3E3E3E3E1E3E7E7A7F07B2
; 0000080008 ■

```

The purpose of computation
is insight not numbers —Hamming

DR. DOBB'S JOURNAL (Software and systems for small computers)

P.O. Box E, Dept. G7, Menlo Park, CA 94025 • \$15 for 10 issues • Remember to include your name, address and zip with your check.

COMMUNICATIONS SOFTWARE FOR S-100 MICROCOMPUTERS

INTEGRATE YOUR MICROCOMPUTER INTO
THE IBM WORLD WITH:

BISYNC - 80/3780: Provides full function IBM 3780 or 2780 emulation for batch data transmission. Price - \$485.

BISYNC - 80/3270: Emulates a full function IBM 3270 for interactive communications. Price - \$485.

BISYNC - 80/ASYNC: Allows asynchronous communications between micros with the speed and extensive error correcting of bisync communications. Price - \$95.

FOR MORE INFORMATION, CONTACT:

 **Micro-Integration, Inc.**

104 Morris Avenue P.O. Box 335
Friendsville, MD 21531

(301) 746-5888

THE ESSENCE of output quality

- *Any* IBM SELECTRIC® can be converted to produce high quality output at an affordable price!
- *Interfaces* directly to S100, Parallel, RS-232 or IEEE-488.
- *Compatible* with TRS-80, Sorcerer, Pet, Apple, Horizon, etc.
- *Why* be printer bound? Prices from \$496 to \$675.

Call
today.



Backspace and Tab
Available NOW!



Escon Products, Inc.
171 Mayhew Way, Suite 204
Pleasant Hill, Ca., 94523
(415) 935-4590

EXECUPOINTS®

Quiet, Portable, Reliable,
Versatile Printing Data
Terminals

80 Print Position



Model 300

80/136
Print Position



Model 3000

FEATURES:

- Built-In Acoustical Coupler
- 10, 15, 30 CPS
- Carrying Case

TWO SPECIAL PURCHASE PRICES

Remanufactured Units with 90-Day Warranty

Model 300 \$1,295

Model 3000 \$1,895

Off Lease Units with 30-Day Warranty

Model 300 \$695

Model 3000 \$895

Buy Direct From The Manufacturer • Maintenance Contract Available
Order Now • Immediate Delivery • Quantity Discounts



Computer Transceiver Systems Inc.
East 66 Midland Avenue • Paramus, NJ 07652
P.O. Box 15 • Phone: (201) 261-6800

**Rx AVAILABLE
WITHOUT
PRESCRIPTION!**

**THE ONLY
SYSTEM OF ITS
KIND YOUR
MICROCOMPUTER
WILL EVER
NEED!**

**GLOBAL™
DATABASE
MANAGEMENT
SYSTEM**

for
PROGRAMMERS, ACCOUNTANTS, BOOK-
KEEPERS, DOCTORS, LAWYERS, PUB-
LISHERS, SCIENTISTS, MANUFAC-
TURERS, WHOLESALERS, RETAILERS,
MANAGERS, LANDLORDS, REAL ESTATE
AGENTS, TEACHERS, STUDENTS, ETC.

**Extremely comprehensive, versatile
user-oriented management system for
database creation and list main-
tenance. Runs under CP/M* and
CBASIC2** on a microcomputer
system in only 40K RAM.**

Completely user-defined file structure
with sequential, random and linked file
maintenance; user-defined number of
fields; data transfer between records;
automatic high speed search
algorithms with global search func-
tion; built-in ISAM; fast sort/merge
utility; record selectable output can be
formatted (with/without headings, col-
umn titles, totals, etc.) and printed on
various forms (labels, envelopes,
preprinted forms, etc.); links to CP/M
commands or programs with
automatic return to Global; provides
status reports on diskette, data file and
hardware environment; disk used as
extended memory.

Supplied on standard 8" IBM disk (inquire about
other formats), complete with BASIC subroutine
library in source code, with
comprehensive manual.

\$295

MANUAL ONLY...\$25

*Trademark of
Digital Research

**Trademark of
Software Systems

Add { Shipping \$2.00
C.O.D. 1.00
Sales Tax
where applicable

DEALER INQUIRIES INVITED

**GLOBAL
PARAMETERS**

1505 Ocean Ave., Brooklyn, N.Y. 11230
212/252-5002

Event Queue

MARCH 1980

March

James Martin Seminar

James Martin will discuss the design and management of distribution processing and networks.

For details of his March appearances write Technology Transfer Institute, POB 49765, Los Angeles CA 90049, (213) 476-9747.

March

Short Courses on Microcom- puters, George Washington

University, Washington DC. Contact the Director of Continuing Engineering Education, George Washington University, Washington DC 20052 or call (202) 676-6106 or (800) 424-9773.

March

Workshops for TRS-80 In- terfacing, 8080-8085 and Z80

Design and Digital Electronics for Instrumentation and Automation, Virginia Polytechnic Institute and State University, Blacksburg VA 24061. For additional information on times and dates, contact Dr Linda Leffel, CEC, Virginia Tech, Blacksburg VA 24061 or call (703) 961-5241.

March 1

Exploring Small Computers,

Albion College, Albion MI. This fair will feature exhibits and seminars on microcomputers and their applications in business, education, and the home. Contact D W Kammer, Dept of Physics,

Albion College, Albion MI 49224.

March 3-5

Office Automation Conference, Georgia World Congress Center, Atlanta GA. A combination conference and exhibition of office computer systems has been developed to help management understand the growing technology of business computer systems. For more information, contact H A Bruno and Associates Inc, 78 E 56th St, New York NY 10022.

March 4 and 5

8th Annual Midwest Digital Equipment Exhibit and

Seminar, Thunderbird Motel, Minneapolis MN. Manufacturers of computer terminals, data communication equipment, peripherals, data acquisition systems and digital test instruments will display their products. Seminars will be held both days. For further information, contact John Bastys Countryman Associates Co, 1821 University Ave, St Paul MN 55104.

March 6-8

Microprocessor Peripherals Workshop, Montgomery

AL. This hands-on workshop includes 27 hours of instruction, with a take-home option and one microcomputer station for every two participants. Contact Paul A Willis, POB 29, Arlington VA 22210.

March 10-12

**1980 National Office Exhi-
bition and Conference,**
Automotive Building,

In order to gain optimum coverage of your organization's computer conferences, seminars, workshops, courses, etc, notice should reach our office at least three months in advance of the date of the event. Entries should be sent to: Event Queue, BYTE Publications, 70 Main St, Peterborough NH 03458. Each month we publish the current contents of the queue for the month of the cover date and the two following calendar months. Thus a given event may appear as many as three times in this section if it is sent to us far enough in advance.

TRS-80® CP/M® & CBASIC® BUSINESS SOFTWARE

All MOD II CP/M's are **not** created equal . . .
Find out why ours is the **Better Business Buy!**

Model I CP/M (rel. 1.5) \$150.00
Model II CP/M (rel. 2.0) 250.00
APH (Automated Patient History) 175.00
RESIDENTIAL PROPERTY ANALYSIS
system 300.00

The Genuine Article:

Osborne & Assoc. CBASIC source programs—
O&A **Payroll** w/Cost Accounting. . . . \$250.00
O&A **Accts. Rec./Accts. Payable** . . . 250.00
O&A **General Ledger** w/Cash Journal. 250.00
O&A CBASIC books for above (each) . . . 15.00

Send 30¢ SASE for CP/M Users Group software list & free "CP/M Primer".

* TRS-80 is a registered trademark of Radio Shack, a Tandy company
* CP/M is a registered trademark of Digital Research
* CBASIC is a registered trademark of Software Systems



(714) 848-1922

8041 NEWMAN AVENUE • SUITE 208 • HUNTINGTON BEACH, CALIFORNIA 92647

TOLL FREE ORDERING



These Fine
Products and More

NORTHSTAR	ASM	KIT	TERMINAL	
HRZ-1-16K-D	1600.	1275.	SOROC IQ-120	760.
HRZ-1-32K-D	1995.	1580.	HAZELTINE 1400	760.
HRZ-2-32K-D	2300.	1900.	HAZELTINE 1500	940.
HRZ-1-32K-Q	2300.	1750.	HAZELTINE 1510	1050.
HRZ-2-32K-Q	2700.	2230.	TELEVIDEO 912	700.
			TELEVIDEO 920	750.
RAM-16K	365.	325.		
RAM-32K	565.	515.		
FPB-A	285.	220.	PRINTERS	
MDS-A-D	710.	660.	BASE-2	450.
MDS-A-Q	880.	830.	TI-810	1580.
EXTRA DRIVE-D	—	350.	CENTRONICS-799	970.
EXTRA DRIVE-Q	—	525.	NEC-5510	2550.
HARD DISC SYSTEM	CALL		NEC-5520	2800.
Most NorthStar computers come standard with real wood cover, 2 serial ports, 1 parallel port, real time clock, disc operating system and NorthStar basic.			SOFTWARE—DISCS—MISC	
			AUTOSCRIBE	325.
			VERBATUM DISCS (10)	28.
			5 FOOT RS-232 CABLE	20.
			10 FOOT RS-232 CABLE	25.

WE WILL TRY TO BEAT ANY ADVERTISED PRICE

A. E. I.

4341 W. Commonwealth Ave Suite D
Fullerton, Calif. 92633
(714) 739-4701 (800) 854-6003

DATA TERMINAL EQUIPMENT — FROM MICROMAIL



LA34 DECwriter IV

\$999.00

- Upper/lower case, 9x7 dot matrix
- 10, 12, 13.2, 16.5 characters/inch
- 2, 3, 4, 6, 8 or 12 lines/inch
- 22"W x 7"H x 15 1/2"D, 25 lbs.
- 110 or 300 baud, RS 232C serial ASCII
- Friction feed, paper width to 15"

New from DIABLO

DIABLO 1640 **\$2,920.00**

Receive-only **\$2,525.00**

High-quality daisywheel printing at 45 cps.

DIABLO 1650 **\$3,070.00**

Receive-only **\$2,675.00**

Metal daisywheel printing at 40 cps.

T.I. 810 printer **\$1,599.00**

- Includes upper/lower case
- 150 characters per second
- RS 232C serial interface
- Adjustable forms tractor

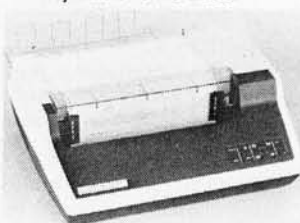

SOROC IQ 120 **\$740.00**

- RS 232C, upper/lower case, full ASCII
- Numeric keypad, protected fields
- Cursor keys plus addressable cursor
- Auxiliary extension port

SOROC IQ 140 **\$1,130.00**

- RS 232C and 20mA current loop
- Extensive editing features
- 25th line terminal status display
- 16 function keys (32 with shift)



NEC Spinwriter

Call or write for prices

To Order: Send certified check (personal or company checks require two weeks to clear) including handling* and 6% sales tax if delivered within California.

*Handling: Less than \$2,000, add 2%; over \$2,000, add 1%. Everything shipped freight collect in factory cartons with manufacturer's warranty.

MICROMAIL

MICROMAIL • BOX 3297 • SANTA ANA, CA 92703
(714) 731-4338

YOU TOO can become a successful computer ENTREPRENEUR!



HOW TO START YOUR OWN SYSTEMS HOUSE is a practical step-by-step guide for the EDP professional or small businessman who wants to enter the micro-computer systems business.

This fact-filled 230-page manual covers virtually all aspects of starting and operating a small systems company. It is abundant with useful, **real-life samples**: contracts, proposals, agreements and a complete business plan are included in full, and may be used immediately by the reader.

Proven, **field-tested solutions** to the many problems facing the small systems house are presented.

From the contents:

- New Generation of Systems Houses
- The SBC Marketplace • Marketing Strategies • Vertical Markets & IAPs
- Competitive Position/Plans of Major Vendors • Market Segment Selection & Evaluation • Selection of Equipment & Manufacturer • Becoming a Distributor • Getting Your Advertising Dollar's Worth • Your Salesmen: Where to Find Them • Product Pricing • The Selling Cycle • Financing for the Customer • Leasing • Questions You Will Have to Answer Before the Prospect Buys • Producing the System • Installation, Acceptance, Collection • Documentation • Solutions to the Service Problem • Protecting Your Product • How to Write a Good Business Plan • Raising Capital

6th edition, Feb. 1980 230 pages

Send \$36.00 (check, VISA or Mastercard) to:

**Essex Publishing Co., Dept 2
285 Bloomfield Avenue
Caldwell, N.J. 07006**

Credit card orders: Send card #, date exp. Add \$2.00 for rush, air mail shipping. N.J. residents add 5% sales tax. For faster shipment on credit card orders, phone (201) 783-6940.

Exhibition Pl, Toronto, Canada.

Subject areas of the conference will include energy conservation, small business computers, micrographics, word processing, telecommunications, copiers, office landscaping, and many others. There will be approximately 100 exhibitors presenting their products and giving demonstrations.

For more information, contact Whitsed Publishing Ltd, Suite 2504, 2 Bloor St W, Toronto, Ontario M4W 3E2 CANADA.

March 11-13

SEMICON/Europa, Zurich, Switzerland.

This show and symposium is the initial step in the organization of a European forum for the exchange of information on the latest semiconductor technology. Included in the topics of presentation are semiconductor materials, device production, and technology; future trends; photovoltaic conversion of solar energy; and standardization of testing and materials. Contact the Semiconductor Equipment and Materials Institute Inc, 625 Ellis St, Suite 212, Mountain View CA 94043.

March 14-16

West Coast Computer Faire, Civic Auditorium and Brooks Hall, San Francisco CA. An expected 15,000 attendees, over 340 exhibits, and more than 100 conference speakers will highlight this year's program. Exhibitor and speaker information may be requested from the Computer Faire, 333 Swett Rd, Woodside CA 94062.

March 15

Annual PACS Computer Games Festival, LaSalle College Ballroom, 20th and Olney, Philadelphia PA. This event is sponsored by the Philadelphia Area Computer Society and the LaSalle College Physics Dept. The Festival hours are from 10 AM to 6 PM. For further information, contact Stephen A Longo, Physics Dept, LaSalle College,

Philadelphia PA 19141, or call (215) 951-1255.

March 17-20

Interface '80, Miami Beach Convention Center, Miami Beach FL. This conference and exposition is devoted to data communications, distributed data processing (DDP), and networking. Approximately 1000 exhibitors are expected, and attendance is anticipated to exceed 12,000. For information, contact Interface '80, 160 Speen St, Framingham MA 01701.

March 17-21

Applied Time Series Analysis, University of California at Los Angeles CA. This course is designed for engineers, scientists, programmers, economists and other users of digital time series who require modern methods of data analysis using the fast Fourier transform (FFT), digital filtering, power spectral densities and correlation functions. The lectures cover topics relating to the Fourier transform, sampling linear systems, convolution, covariance, digital filtering, power and cross-spectral density functions, and introductions to new methods in spectral analysis and rotating machinery analysis. For more information, contact UCLA Extension, 10995 Le Conte Ave, Los Angeles CA 90024.

March 18-20

Electrical Power Problems: The Mathematical Challenge, Seattle WA. This conference is sponsored by the Society for Industrial and Applied Mathematics (SIAM). The program is designed to bring together experts from power engineering and applied mathematics fields to focus on electrical power problems and the applied mathematics techniques relevant to their solution. Contact SIAM, 33 S 17th St, Philadelphia PA 19103.

March 20

Electronic Road Shows, Castaways Restaurant, Bur-

From S-100 to IEEE-488

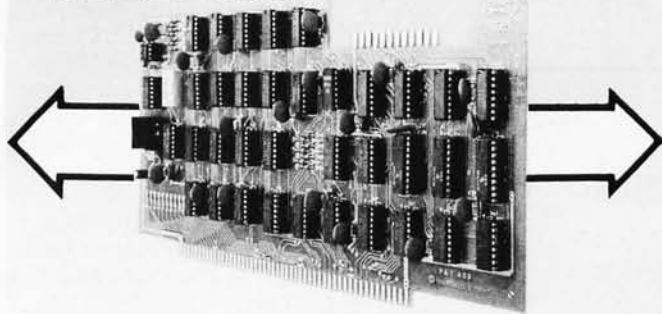

P&T-488 + S-100 computer = Intelligence for your Instrumentation System

The P&T-488 permits an S-100 computer to operate as a talker, listener, or controller on the IEEE-488 instrumentation bus for less than half the cost of calculator-based systems. Software packages which give access to the 488 bus from high level languages such as BASIC are available for CP/M, North Star DOS /BASIC, and Cromemco CDOS. Or "roll your own" system with the custom system package of assembly language drivers. P&T-488, assembled and tested, + any software package: \$400 (domestic USA)



PICKLES & TROUT
P.O. BOX 1206, GOLETA, CA 93017, (805) 967-9563

Main/Frames from \$200

Main/Frames from \$200

- 14 Basic Models Available
- Assembled & Tested
- Power Supply: 8v@15A, ± 16v@3A
- 15 Slot Motherboard (connectors optional)
- Card cage & guides
- Fan, line cord, fuse, power & reset switches, EMI filter
- 8v@30A, ± 16v@10A option on some models

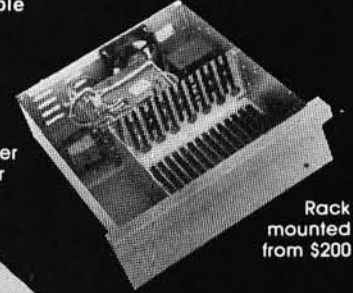

Rack mounted from \$200

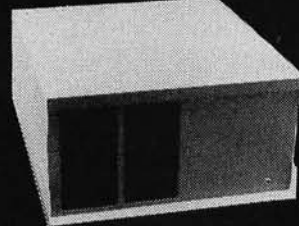

8" Floppy Main/Frame (includes power for drives and mainframe) from \$365

Write or call for our brochure which includes our application note:

'Building Cheap Computers'

INTEGRAND

8474 Ave. 296 • Visalia, CA 93277 • (209) 733-9288
We accept BankAmericard/Visa and MasterCharge



on computers, peripherals, software and other Radio Shack® products.

Offered Exclusively By

Pan American Electronics

INCORPORATED

1117 CONWAY MISSION, TEXAS 78572

TOLL FREE ORDER NUMBER 800/531-7466

TEXAS AND MAIN TELEPHONE NUMBER 512/581-2765



NO ONE CAN GIVE YOU A BETTER DEAL ON TRS-80 COMPUTERS!!

OUR Radio Shack® Merchandise is New and covered by Radio Shack® Warranties

WE PAY Domestic U.P.S. Shipping & Insurance on minimum orders

NO TAXES are collected on out-of-state Shipments

TOLL FREE Order Number

OPEN 8:00 a.m. to 6:00 p.m., Central Time, Monday through Friday; 9:00 a.m. to 6:00 p.m., Saturday

Come Help Us Celebrate The Child

St. Jude Children's Research Hospital continues its search for life-saving knowledge about childhood diseases. And this search continues because people care. Help us celebrate the child by sending your tax-deductible check or request for further information to St. Jude Children's Research Hospital, 539 Lane Ave., Memphis, TN 38105.



information to St. Jude Children's Research Hospital, 539 Lane Ave., Memphis, TN 38105.

ST. JUDE CHILDREN'S RESEARCH HOSPITAL
Danny Thomas, Founder

bank CA. This traveling exhibition of components, materials, and instruments is being produced by the Electronic Representatives Association (ERA). Over eighty ERA member firms will participate, and products from over 700 electronic companies will be displayed. For more information, contact the Southern California ERA office, 20969 Ventura Blvd, Suite 9, Woodland Hills CA 91364.

March 24-26

Data Entry Management and Supervision Seminar, Cherry Hill NJ. This course deals with the practical aspects of data entry, and the problems encountered that are common to supervisors and managers. Concepts, techniques, motivation, training, and productivity will be covered. The fee is \$415 for subscribers of MIC publications and \$445 for non-subscribers. For more information, contact MIC, 140 Barclay Ctr, Cherry Hill NJ 08034.

March 24-28

Fourth European Conference on Electrotechnics, Stuttgart. This conference will review recent developments, trends, and applications in the field of microelectronics. Microprocessors, computer communication, industrial electronics, applications of microelectronics in the automobile and in medicine, and other topics will be covered. The conference language will be English. Contact Professor Dr W E Proebster, IBM Deutschland GmbH, Postfach 80 08 80, D-7000 Stuttgart 80 WEST GERMANY (BRD).

March 26-28

Viewdata '80, Wembley Conference Centre, London England. Viewdata '80 is an international exhibition and conference on video-based systems and microcomputer industries. The British Post Office is presenting the Prestel Show, which is about electronic mail services.

Contact TMAC, 680

For Your TRS-80
DISK SYSTEM

ElectraSketch®

Add Animation to your TRS-80 Programs

- Animation Compiler and Graphics Editor Package
- Add smooth, fast action to basic programs
- Create ad layouts, newsletter covers, posters

\$14.95

Write or call for complete catalog

MACROTRONICS, inc.®
 1125 N. Golden State Blvd. / Suite G
 Turlock, CA 95380 (A)
 (209) 667-2888 / 634-8888

We are experiencing telephone difficulties, please keep trying.

California residents add 6% tax

GOMOKU

Can you find black's best move in the board position on the right?

Our program can. (Black plays on the points marked 1 thru 7).

Five Stones Software announces a Gomoku program for North Star Horizon DOS and CP/M based systems. The program has been written by the current North American champion and has the following features.

- . book of openings with 200 entries
- . fast response to a four being played
- . ability to take back moves
- . 19 x 19 board
- . blinking of last move by computer
- . carriage return not necessary for most moves
- . recent moves displayed along with board
- . ability to customise to different screen sizes.

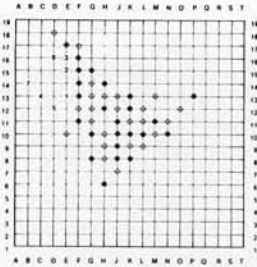

The program requires a minimum of 32K bytes of RAM, and is available for North Star or CP/M on double density 5 1/4" diskette for \$29.95, Visa or Mastercharge accepted. For more information contact

Five Stones Software
 P.O. Box 1369, Station B,
 Ottawa K1P 5R4, Canada
 CP/M is a trademark of
 Digital Research

Name _____
 Address _____
 City _____
 State _____ Zip _____

Gomoku 29.95
 Ontario residents add 7% tax
TOTAL

- Master Charge CP/M (origin 100H)
 Visa North Star

Credit Card Number _____
 INTERBANK NO. FOR MASTERCHARGE _____
 SIGNATURE _____
 Expiration Date MONTH _____ YR. _____



6809!

INTRODUCING THE NEW STATE-OF-THE-ART IN MICROCOMPUTER SOFTWARE.

Call or write today for our free catalog.

MICROWARE

5835 Grand Ave. • P.O. Box 4865
 Des Moines, IA 50304 • 515/279-8844

Call now for a quotation
 (312) 733-0497

U.S. ROBOTICS, INC. 1035 W. LAKE ST. CHICAGO, ILL. 60607

The 550 BANTAM from Perkin-Elmer



\$799

All the features of the Hazeltine 1400 & LSI ADM-3A plus

- Upper/Lower Case
- 7x10 Character Matrix
- White or Black Characters
- Transparent Mode
- Addressable Cursor
- Tab Function
- Backspace Key
- Shiftlock Key
- Print Key
- Integrated Numeric Pad
- Editing Functions
- Extremely Compact: 15" W x 19" D x 14" H
- Silent fan-free operation

All products
 in stock!

LA34 DECwriter IV



\$1199

- Tabs
- 132 columns
- 10, 12, 13.2, 16.5 characters/inch
- 2, 3, 4, 5, 8 or 12 lines/inch
- Optional tractor feed
- 110 or 300 baud
- RS232C/ASCII
- Friction feed/up to 15" wide paper
- 9x7 dot matrix, impact printing
- Upper/lower case

Teletype Model 43 KSR \$1049

- 110 or 300 baud
- RS232C/ASCII
- Pin feed/8 1/2" H x 11" W paper is perfect for filing and copying.

PENRIL 300/1200 MODEM Originate/Auto-Answer



\$799

- 0-300 or 1200 baud
- Bell 212A & 103/113 compatible
- 1 year warranty
- Stand alone
- RS232
- Full duplex over voice grade phone lines
- FCC certified for direct connection to phone lines via RJ11C voice jack (standard extension phone jack)



- 132 columns
- Upper/lower case, true descenders
- Dot matrix, impact printing

Connect your TRS-80, Apple or ANY other computer to the phone lines with the...

USR-330 Originate/ Auto-Answer Modem



\$339

FCC certified for direct connection to phone lines via standard extension phone jack

- 0-300 Baud
- Bell 103/113 compatible
- Stand Alone
- RS232
- 1 Year Warranty
- Crystal Controlled
- State of the Art LSI circuitry
- 5 stage active filters

USR-310 Originate Acoustic Coupler



\$159

DATA DISK SYSTEMS

PROFESSIONAL SOFTWARE FOR NORTH STAR SYSTEMS

DIGITAL RESEARCH

CP/M 2.0 — Digital Research's latest disk operating system for 8080/8085/Z80 based microcomputers, now specially tailored for the North Star disk systems. Includes ED text editor, DDT debugger, ASM assembler, additional utility programs and complete documentation. CP/M 2.0 is upward compatible with earlier releases and makes a wealth of professional software available to your system. \$150/\$25

TEX — A powerful text formatter. Produces finished copy with automatic page numbering, left and right margin justification, indentation, page headers, line centering and other quality features. Output may be vectored to printer, disk or console. \$70/\$15

MAC — 8080 Macro assembler. Allows use of library programs, greatly increasing programming efficiency. Uses Intel macro conventions. Assembly logfiles allow listing, hex and symbol table outputs to be directed to disk, printer, console or combination. A tremendous development aid. \$85/\$15

SID — Symbolic Instruction Debugger for the 8080. Allows multiple break points with user set pass counter. Displays user labels during debugging when used with MAC. Greatly reduces hard-copy listing requirements. Includes back-trace and histogram utilities. A must for serious software development. \$85/\$15

ZSID — Same as SID except incorporates complete Z80 instruction set and uses Z-80 mnemonics. \$95/\$15

DESPOOL — Allows simultaneous printing of disk files and user access to other programs. No need to stop production while lengthy printouts are in progress. \$45/\$5

SOFTWARE SYSTEMS

CBASIC-2 — A commercially oriented, compiler-extended disk BASIC. Self documenting, using full length variable labels without penalizing speed. Compiler permits distribution of software without releasing source code. \$105/\$15

California residents add 6% sales tax.
Specify single, double or quad capacity.
Additional formats available soon.
Structured Systems Group programs require CP/M and CBASIC-2.
*CP/M is a registered trademark of Digital Research.
†Software and documentation/documentation only.



Datadisk Systems, P.O. Box 195, Poway, CA 92064, (714) 578-3831

BUSINESS SOFTWARE FROM STRUCTURED SYSTEMS GROUP

GENERAL LEDGER — A comprehensive applications package for business accounting or CPA multi-client write up. Produces financial reports to user defined specifications. Interactive posting, balance sheet, income statement, general and cash disbursement journals, sort, multiple profit centers, accounts distribution and much more. Outstanding package. \$895/\$25

ACCOUNTS RECEIVABLE — A complete open item or balance forward system. Operates alone, or interfaces with General Ledger. Produces customer statements, aged trial balance, on-line inquiry, sales reports, reminder notices and more. \$695/\$25

ACCOUNTS PAYABLE — A powerful cash management system. Aged account statements, writes checks, cash requirements projection, General Ledger update and more included. Stand alone operation or interfaces with General Ledger and QSORT. \$695/\$25

NAD — Name and Address System — Stores mailing lists on disk. Prints mailing labels or lists additional references information. Selective data extraction. \$75/\$10

QSORT — A generalized, full disk sort/merge package. Fast and flexible. Multiple key sorting. \$95/\$15

LETTERIGHT — Word processing for the business office. Produces professional correspondence, letters, envelopes, and more. High speed production with minimal training. Multiple personalized letters produced when used with list formed by NAD. \$175/\$20

ANALYST — Generalized data base management program. Stores and retrieves disk data producing user formatted reports. Interactive input. Easy to use. Tremendous versatility. \$225/\$20

INVENTORY — Complete inventory control program limited in capacity only by your disk size. On-line inquiry, average valuation, reorder and activity reports with report range option. Menu driven and fully auditable, the system uses full screen formatting and permits user defined record numbers. \$795/\$25

NOW—AN AFFORDABLE HARD DISK
Ask about our 13.2 megabyte Winchester technology hard disk business system. Uses all above listed software. Price varies with software configuration.

Beach St, Suite 428, San Francisco CA 94109.

March 30

Greater Baltimore Hamboree and Computefest, Maryland State Fairgrounds, Timonium MD. Personal, dealer, and small business computer displays and exhibits will be featured. Space is available outside the fairgrounds for tailgate sales and swaps. For more information, contact Joseph Lochte Jr, 2136 Pine Valley Dr, Timonium MD 21093.

March-June

Computer and Office Systems Expo and Conference. This is an exposition for marketers of office systems equipment. The show and conference will focus on the local problems and opportunities of each region. The exposition and conference will be held in major cities around the nation. Contact The Conference Co, 60 Austin St, Newton MA 02160, or phone (617) 964-4550.

Signal Processing, Fairmont Hotel, Denver CO. The IEEE Acoustics, Speech and Signal Processing Society is sponsoring this conference devoted to experimental and theoretical aspects of signal processing, speech, and acoustics. For more information, contact IEEE, 1100 14th St, Denver CO 80202.

April 10

Electronic Road Shows, Anaheim Convention Center, Anaheim CA. See March 20th for details.

April 11-12

10th Annual Virginia Computer Users Conference. This conference is sponsored by the Virginia Tech Association for Computing Machinery (ACM) student chapter. The topics of discussion will be programming languages and system and personnel management. For more information, contact VCUC10, 562 McBryde Hall, VPI&SU, Blacksburg VA 24061.

April 13-16

A Gateway to the Use of Computers in Education, Chase Park Plaza Hotel, St Louis MO. The purpose of this convention is to provide a forum for the exchange of information and ideas between individuals, to inform educators of developments in computer technology, and to expose participants to innovations in computing which can be utilized in the field of education.

Educators are encouraged to exhibit and make presentations of instructional microprocessor materials during the convention. Contact the Association for Educational Data Systems (AEDS), POB 951, Rolla MO 65401.

April 14-18

High-Speed Computer Organization, 6266 Boelter Hall, UCLA Extension, Los Angeles CA. This course is for computer designers, system architects, project leaders and managers. The course provides an understanding of the principles of high-speed com-

APRIL 1980

April 1-2

Southeast Printed Circuits and Microelectronics Exposition, Sheraton-Twin Towers Convention Center, Orlando FL. This show is a specialized event devoted entirely to the packaging, production and testing of printed circuits, multilayers, semiconductor devices, and hybrids. The conferences are aimed at electronics specialists. Contact ISCM, 222 W Adams St, Chicago IL 60606.

April 9-11

The Practical APL Conference, Washington DC. This conference is addressed to business executives and systems designers. For more information, contact Joan Gurgold, STSC, 7 Holland Ave, White Plains NY 10603.

April 9-11

International Conference on Acoustics, Speech and

THE BEST MICRO COMPUTER — Exporter —



Fast + Efficient

Our Foreign Customers Receive:

- Purchasing Agent's Service
- Wholesale Discounts
- 220 V/50 Hz Power

Products

- | | |
|-------------------|-------------------|
| NORTH STAR | TELEVIDEO |
| TEXAS INSTRUMENTS | BASE 2 |
| SOROC | KONAN CORPORATION |
| INDUSTRIAL MICRO | CENTRONICS |
| HAZELTINE | INTEGRAL DATA |
| EXIDY SORCERER | VERBATIM |
| MICRO PERIPHERALS | + More |

P.O. Box 1118 Scottsdale, Arizona 85252 U.S.A.
Tel: 602-994-3435 TELEX: 165745

Circle 188 on inquiry card.

**Z-80/TRS-80™ Users
BOOK YOU'VE WANTED NOW CAN BE YOURS
THE Z-80: HOW IT WORKS
(THE PROGRAMMERS PERSPECTIVE)**

By Monte Corum

Best Most Complete Reference Yet
cpu Operation Explained
Addressing Modes Demystified
Register Functions Described
Instructions Defined
Interrupts Diagrammed
Cycles Outlined Formats Described
Execution Described in Text,
Notation and Diagrams
Meaningful Analysis of 698 Commands
in Formatted, Usable Tables
Simple, Consistent Notation and Formats
A Programmer's Book, Beginner or Experienced
Ideal Text for Class Instruction
Priced: \$17.95 Plus Tax and Shipping
VISA & MSTRCHRG-NUMBER AND EXP. DATE
PREPAID WE SHIP

MICROWARE ASSOCIATES, INCORPORATED
9301 N. 58th St. DPT. AAA
SCOTTSDALE, AZ. 85253

DEALER INQUIRIES INVITED

* TRS-80 IS A TRADEMARK OF TANDY CORP.

3 LIGHT PEN

**PET
APPLE
TRS-80
(Level II)**

- Bypass the keyboard and interact directly with the screen. Makes your computer more versatile for the novice as well as the more sophisticated user.
- The use of the 3-G Light Pen is limited only by your imagination! Use it to experiment with graphics, display a menu for quick data retrieval, as a teaching tool with your child, to proportion recipes instantly, or to play unique games.
- At a major medical center an anesthesiologist uses our pen to select proper dosages. In Holland they use it to create graphics. A man in New York uses it to teach his pre-school age daughter how to match capital with lower case letters. Teachers are using it in science and foreign language classes.
- NO ASSEMBLY NECESSARY. READY TO PLUG IN. Detailed sample programs included. Complete documentation so you can write your own programs in BASIC. No machine language coding necessary. All Professional models plug into machine ports and don't require batteries. Economy model plugs into tape recorder and batteries are included.
- YOU GET: 1) 3-G Light Pen
2) Demo-Game Cassette (with Professional TRS-80 and Apple)
3) Sample Program
4) Complete documentation and instructions.



MANY GAMES AND OTHER LIGHT PEN SOFTWARE AVAILABLE

MAIL COUPON OR CALL TODAY FOR IMMEDIATE DELIVERY

3G COMPANY, INC. DEPT. BT (503) 662-4492
RT. 3, BOX 28A, GASTON, OR 97119

- TRS-80 Economy \$19.95 TRS-80 Professional \$34.95 PET Professional \$29.95 Apple Professional \$32.95

Yes, I want to make my computer more versatile. Rush me _____ 3-G Light Pens (Add \$1.50 for mailing and handling - \$6.00 foreign.)

Enclosed is: check or money order Master Charge Visa



Card No. _____ Exp date _____
NAME _____
ADDRESS _____
CITY _____ STATE _____ ZIP _____

REMEMBER, 3G OFFERS A 30 DAY UNCONDITIONAL MONEY BACK GUARANTEE!

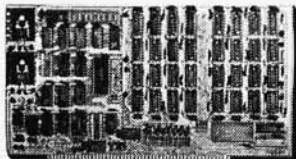

64K BYTE EXPANDABLE RAM

DYNAMIC RAM WITH ON BOARD TRANSPARENT REFRESH GUARANTEED TO OPERATE IN NORTHSTAR, CROMEMCO, VECTOR GRAPHICS, SOL. AND OTHER 8080 OR Z-80 BASED S100 SYSTEMS * 4MHZ Z-80 WITH NO WAIT STATES.
* SELECTABLE AND DESELECTABLE IN 4K INCREMENTS ON 4K ADDRESS BOUNDARIES.
* LOW POWER—8 WATTS MAXIMUM.
* 200NSEC 4116 RAMS.
* FULL DOCUMENTATION.
* ASSEMBLED AND TESTED BOARDS ARE GUARANTEED FOR ONE YEAR AND PURCHASE PRICE IS FULLY REFUNDABLE IF BOARD IS RETURNED UNDAMAGED WITHIN 14 DAYS.

	ASSEMBLED / TESTED
64KRAM	\$595.00
48K RAM	\$529.00
32K RAM	\$459.00
16K RAM	\$389.00
WITHOUT RAM CHIPS	\$319.00

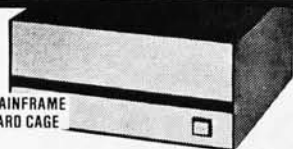

5100 MAINFRAME AND CARD CAGE

- * W/ SOLID FRONT PANEL \$239.00
- * W/ CUTOUPS FOR 2 MINI-FLOPPIES \$239.00
- * 30 AMP POWER SUPPLY \$119.00



VISTA V-200 MINI-FLOPPY SYSTEM

- * S100 DOUBLE DENSITY CONTROLLER
- * 204 KBYTE CAPACITY FLOPPY DISK DRIVE WITH CASE & POWER SUPPLY
- * MODIFIED CPM OPERATING SYSTEM WITH EXTENDED BASIC \$695.00
- * EXTRA DRIVE, CASE & POWER SUPPLY \$395.00

16K X 1 DYNAMIC RAM

THE MK4116-3 IS A 16,384 BIT HIGH SPEED NMOS. DYNAMIC RAM. THEY ARE EQUIVALENT TO THE MOSTEK, TEXAS INSTRUMENTS, OR MOTOROLA 4116-3.
* 200 NSEC ACCESS TIME, 375 NSEC CYCLE TIME.
* 16 PIN TTL COMPATIBLE.
* BURNED IN AND FULLY TESTED.
* PARTS REPLACEMENT GUARANTEED FOR ONE YEAR.
\$8.50 EACH IN QUANTITIES OF 8

BETA
COMPUTER DEVICES

1230 W. COLLINS AVE.
ORANGE, CA 92668
(714) 633-7280

KIM/SYM/AIM-65—32K EXPANDABLE RAM

DYNAMIC RAM WITH ON BOARD TRANSPARENT REFRESH THAT IS COMPATIBLE WITH KIM/SYM/AIM-65 AND OTHER 6502 BASED MICROCOMPUTERS.
* PLUG COMPATIBLE WITH KIM/SYM/AIM-65. MAY BE CONNECTED TO PET USING ADAPTOR CABLE. SS44-E BUS EDGE CONNECTOR.
* USES +5V ONLY (SUPPLIED FROM HOST COMPUTER BUS). 4 WATTS MAXIMUM.
* BOARD ADDRESSABLE IN 4K BYTE BLOCKS WHICH CAN BE INDEPENDENTLY PLACED ON 4K BYTE BOUNDARIES ANYWHERE IN A 64K BYTE ADDRESS SPACE.
* BUS BUFFERED WITH 1 LS TTL LOAD.
* 200NSEC 4116 RAMS.
* FULL DOCUMENTATION
* ASSEMBLED AND TESTED BOARDS ARE GUARANTEED FOR ONE YEAR, AND PURCHASE PRICE IS FULLY REFUNDABLE IF BOARD IS RETURNED UNDAMAGED WITHIN 14 DAYS.

	ASSEMBLED / TESTED
WITH 32K RAM	\$419.00
WITH 16K RAM	\$349.00
WITHOUT RAM CHIPS	\$279.00
HARD TO GET PARTS ONLY (NO RAMS)	\$109.00
BARE BOARD AND MANUAL	\$49.00

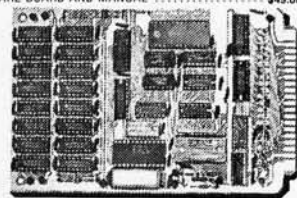

CALIF RESIDENTS PLEASE ADD 6% SALES TAX. MASTERCARD & VISA ACCEPTED. PLEASE ALLOW 14 DAYS FOR CHECKS TO CLEAR BANK. PHONE ORDERS WELCOME.

puter organization and their use in cost-effective systems. Several designs for high-speed computers are presented and compared.

For more information, contact the UCLA Extension at POB 24901, Dept K, UCLA Extension, Los Angeles CA 90024.

April 21-25

National Micrographics Association 29th Annual Conference and Exposition, Sheraton Center Hotel and Coliseum, New York NY. The theme for the show is "Focus on Productivity in Office Management." Highlighting the conference and exposition will be presentations and talks concerning the use in offices for computer systems and related items.

For more information, contact the Conference Dept, National Micrographics Association, 8719 Colesville Rd, Silver Spring MD 20910.

April 23-25

International DP Training Conference, Hyatt Regency, Chicago IL. The theme for this event will be "The 1980s: The Information Decade." The conference is a symposium for data processing experts and corporate training executives. For information, contact

Deltak Inc, 1220 Kensington Rd, Oak Brook IL 60521.

April 27-30

17th Numerical Control Society Annual Meeting and Technical Conference, Hartford Civic Center, Hartford CT. This convention will offer technical sessions covering such areas as computer-aided design engineering, business management, tool design and graphics; computer-aided assembly, facilities planning, inventory control, and management information systems; numerical control in various areas; data base structure and management; and other educational programs. There is also a large exhibition being presented.

For more information, contact Numerical Control Society, 1800 Pickwick, Glenview IL 60025.

April 28-30

Managing Technical Programs and Projects, White Plains NY. For more information, contact the Institute for Advanced Professional Studies, One Gateway Ctr, Newton MA 02158.

April 30-May 2

Computerized Office Equipment Expo, O'Hare Exposition Center, Rosemont IL. The latest developments in

computers, word processors, copiers/duplicators, telephone systems, and other business equipment will be featured. The seminars will cover guidelines on buying computer systems, telephone and copier systems; the use of word processors, and more. Contact Industrial and Scientific Conference Management Inc, 222 W Adams St, Chicago IL 60606.

MAY 1980

May

IEEE Computer Society Conferences and Meetings. For a list of events, contact the Executive Secretary, Harry Hayman, POB 639, Silver Spring MD 20901, or phone (301) 439-7007.

May 5-11

Engineering, Science, and Public Policy, 16th Annual Meeting, Baltimore Convention Center, Baltimore MD. Companies from around the world and the US will be exhibiting. The conference is being sponsored by the AIAA. Contact Lawrence Craner, Director of Technical Displays, AIAA, 1290 Avenue of the Americas, New York NY 10019, or the Conference General Chairman, Laurence Adams at Martin Marietta

Aerospace.

May 6-8

Micro/Expo 80, Centre International de Paris, Paris France. This is one of the leading shows in Europe for microcomputer users and manufacturers. Exhibits of new equipment, presentations, games, educational materials, and more will be featured. For more information, contact Sybex Inc, 2020 Milvia St, Berkeley CA 94704.

May 6-8

The 7th International Symposium on Computer Architecture, La Baule, France. This symposium will consist of discussions and readings in the following areas: distributed architectures, special-purpose architectures, hardware description languages, fault-tolerant architectures, high-speed computers, control schema, evaluation of architecture performance, and more.

Contact, Daniel E Atkins, Dept of Electrical and Computer Engineering, University of Michigan, Ann Arbor MI 48109.

May 6-10

8th Annual Canadian Association for Information Science, Toronto, Canada. Technology, commodity, and rights are the themes of this conference. Topics will

AGENS™

LOW COST ASSEMBLY GENERATION SYSTEM

You can assemble machine language programs for any of the popular 8 and 16 bit microcomputers.

You can use this meta-assembler to generate procedures and structures that best fit your applications.

This system is hosted on your Z-80 computer using CP/M and 24K or more bytes of memory.

The Works. Iterative passes for forward ref optimization, subscripts, remote names, macros, functions, externals, relocation classes and more.

BONUS: Source link loader file so you can customize your system.

\$170: AGENS on 8" diskette, Loader, sample generators and manual.

\$27: Manual only.

RBB Software Products™

P.O. BOX 2111
YORBA LINDA, CALIFORNIA 92686
(714) 637-5965

MICAH

MICROPLOT

Versatile Printer Graphics Package

*** Features ***

- Turns any Daisywheel or Thimble-type printer into an incremental pen-plotter
- Moves print-head in large increments horizontally, vertically or both at the same time
- Plots and prints text at the same time with high quality graphic resolution and readability
- Plots at high speeds
- Plots bi-directionally and in 360°
- Allows for creative graphics and report generation
- Fully documented FORTRAN subroutines
- CDOS runs under Cromemco FORTRAN IV
- CP/M runs with MicroSoft FORTRAN compiler

*** Hardware Required ***

- 8080 or 280 processor
- 2" or 8" drives to access FORTRAN libraries
- 12K RAM, but ...
- Suggest 64K for large plot programs
- Daisywheel or Thimble Type Printer

\$195 per package

\$50 Special Demo Package Specify Printer Model

TO ORDER
COD adds \$5 handling
Call add 6% sales tax
Credit Cards accepted

*** DEALER INQUIRIES INVITED ***

MICAH'S PRODUCTS OF DISTINCTION

- OSBORNE BUSINESS SOFTWARE (in EBASIC 2 & 16k)
- CBIOS (CP/M for Cromemco Computers)
- MICROPLOT (Versatile Printer Graphics)
- DCP 1 (Disk Utilities for CP/M and CDOS)
- DCP 2 (Disk Utilities for Cromemco)
- DCP 3 (DCP 2 Expanded)
- SPOOL (Cromemco Format Utility)
- EXPAND (Run Cromemco Software on CP/M)
- BLACKJACK (Tutorial Casino Action)
- DRIVE (Customized Printer Drivers)
- DBMS Conversion to NAD

• Call or Write for Free Catalogue and More Information •

• We will Customize any of our programs at our Standard Consulting Rates •

Ah! MICAH . . . Satisfy'n' Software

That turns your system on!

MICRO Applications and Hardware

• CONSULTANTS and SOFTWARE DEVELOPERS •

MICAH Box 22212 San Francisco, California 94122 USA phone: 415/664-0778

9 new kits! ANALOG PERIPHERAL FUNCTIONS

... in touch with reality!

QK-100	Triple A - D Converter	\$36.95
QK-101	Dual Air Temperature Sensors	26.95
QK-102	Dual Ground Moisture Sensors	29.95
QK-103	Power Supply with Dual Sockets	29.95
QK-104	Dual Liquid Temperature Sensors	32.95
QK-105	Dual Photo Sensors	27.95
QK-106	Dual Water Level Sensors	34.95
QK-108	Dual Surface Temperature Sensors	30.95
QK-109	Dual Hall-Effect DC Magnetic Sensors	54.95
QK-110	Multiplier and Voltage-Controlled Amp	43.95
QK-112	Peak Sense and Hold/Sample and Hold	28.95
QK-115	8/16 Input Analog Multiplexer	38.95
QK-122	Dual Instrumentation Amplifier	24.95
QK-124	Log and Anti-Logarithmic Functions	40.95
QK-133	Multiple Audible Alarm	25.95
QK-134	Multiple Analog Comparators	39.95
QK-138	Dual "People" Sensors	34.95
QK-900	Socket and Mounting Board	8.95

sensors



AVAILABLE IN ASSEMBLED MODULES

(602) 299-9831

CALL Q-KIT

P.O. BOX 35879

WITH YOUR CUSTOM

TUCSON,

SYSTEM REQUIREMENTS!

ARIZONA 85740

a division of j.r. conwell corporation

W
H
O
L
E
S
A
L
E
S
O
N
L
Y

the scene opens onto a well lit room with , ARNOLD ZIEBACK, ace programmer finishing up on a NEW program.....



his concentration is broken for a brief moment... UNKNOWN to ARNOLD, he will do something that many others have done in the past.....



as ARNOLD'S fingers, frantically, fly across the keyboard..... he is about to cross over into obscurity.....

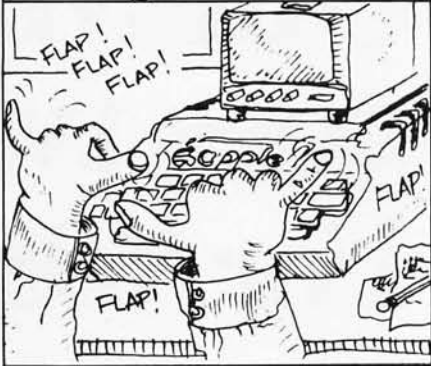

...only missed it by that much!!...one silly centimeter... RESET!!!

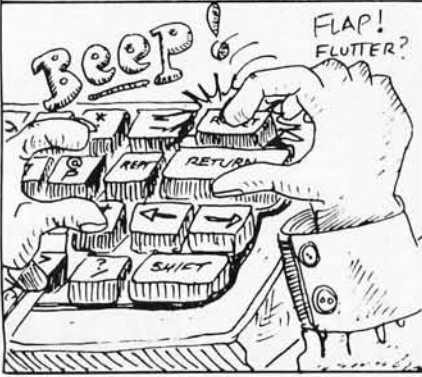

he has hit RESET, instead of hitting RETURN... Alas, if he only knew about ta da..... ResetGuard™..... FIN



ResetGuard™ is the solution to the problem of accidentally hitting the RESET key. With ResetGuard, you must press the RESET key TWICE in one second to RESET the computer!!! FINALLY

SOFTAPE

ORDER FORM

Yes I'm tired of hitting reset at the wrong time.

Please send me _____ reset guards *\$34.95 ea.

master charge

VISA

Name _____

Address _____

City _____

State _____ Zip _____

10432 Burbank Boulevard • North Hollywood, California 91601

cover information in the marketplace, information transfer and policy issues, right to access, new information technologies and applications, and other subjects. For more information, contact the Program Chairman, 8th Annual CAIS Conference, Technical Information Centre, Bell Northern Software Research, 12th floor, 522 University Ave, Toronto Ontario M5G 1W7 CANADA.

May 13-15

Electro/80 Show and Convention, Hynes Auditorium and Boston Sheraton, Boston MA. This show consists of presentations and exhibitions by manufacturers in the computer industry. Contact Electronic Conventions Inc, 99 N Sepulveda Blvd, El Segundo CA 90245.

May 13-16

9th Annual Conference of MUMPS Users Group, Islandia Hyatt House, San Diego CA. The meeting will bring

together scientific, medical, and business professionals to discuss current research and application development. Areas of participation are paper presentations, workshops and tutorials, and vendor exhibits. Contact Dr Jack Bowie, MUG 80 Program Chairman, The MITRE Corp, Mail Stop 641, 1820 Dolley Madison Blvd, McLean VA 22102.

May 14-16

Carnahan Conference on Crime Countermeasures, Carnahan House, Lexington KY. This conference is devoted to the application of engineering and science to law enforcement, security, and crime prevention. Emphasis will be on effective research and development in computer security.

Contact the Office of Continuing Education, College of Engineering, University of Kentucky, Lexington KY 40506.

May 15

Electronic Road Shows,

Griswold's Restaurant, Pomona CA. See March 20th for details.

May 19-22

1980 National Computer Conference, Anaheim Convention Center, Anaheim CA. The conference program will include more than 120 sessions covering computing careers and education, office automation, and auditing in the area of management; computers in earth resource management, human services, and word processing in the field of applications; programming languages, design techniques and methodology, and voice simulation and recognition in software; earth resources, education, women and minorities in the computing discipline in the area of social implications; micro-computers and mini-computers, computer architecture, and new concepts in memories in the area of hardware.

For information, contact American Federation of In-

formation Processing Societies Inc, 1815 N Lynn St, Arlington VA 22209.

May 21-22

2nd Clemson Small Computer Conference, Clemson University, Clemson SC. This conference will discuss applications in engineering, science, manufacturing, small business data processing, and education. Contact William J Barnett, Electrical and Computer Engineering Dept, Riggs Hall, Clemson University, Clemson SC 29631.

May 24-25

Amateur Radio and Computer Hobbyists 2nd Annual Convention, Cervantes Convention Center, St Louis MO. Speakers, presentations, equipment displays, and a flea market will be featured. For more information, contact the Gateway Amateur Radio Association Inc, POB 68, Marissa IL 62257. ■

Our MacroFloppy™ goes twice the distance. For \$695.

Introducing the Micropolis MacroFloppy™:1041 and :1042 disk drive sub-systems. For the S-100/8080/Z-80 bus. Packing 100% more capacity into a 5¼-inch floppy disk than anyone else. 143K bytes, to be exact. For as little as \$695.

The MacroFloppy:1041 comes with the Micropolis Mod I floppy packaged inside a protective enclosure (without power supply). And includes an S-100 controller. Interconnect cable. Micropolis BASIC User's Manual. A diskette containing Micropolis BASIC, and a compatible DOS with assembler and editor. The :1041 is even designed to be used either on your desk top, or to be integrated right into your S-100 chassis.

The MacroFloppy:1042 comes with everything the :1041 has, and more. Such as d.c. regulators, its own line voltage power supply, and, to top it off, a striking cover. Making it look right at home just about anywhere.

Both MacroFloppy systems are fully assembled, tested, burned-in, and tested again. For zero start-up pain, and long term reliability. They're also backed up by our famous Micropolis factory warranty.

And both systems are priced just right. \$695 for the MacroFloppy:1041 and \$795 for the MacroFloppy:1042.

You really couldn't ask for anything more.

At Micropolis, we have more bytes in store for you.

For a descriptive brochure, in the U.S. call or write Micropolis Corporation, 7959 Deering Avenue, Canoga Park, California 91304. Phone (213) 703-1121.

Or better yet, see your local dealer.

MICROPOLIS™
More bytes in store for you.

ED SMITH'S SOFTWARE WORKS 6809 SOFTWARE TOOLS

RRMAC M6809 RELOCATABLE RECURSIVE MACROASSEMBLER. The one assembler that contains *real* macro capabilities (see our May, June BYTE ad). RRMAC is designed with the assembly language programmer in mind and contains many programmer convenience features. RRMAC contains a mini-editor, supports spooling or co-resident assembly, allows insert files, is romable, generates cross-references, execution times, lists target addresses of all relative references.
M69RR \$150.00

SGEN M6809 DISASSEMBLER/SOURCE GENERATOR will produce source code (with symbolic labels) suitable for immediate re-assembly or re-editing. The output source file can be put on tape or disk. A full assembly type output listing with labels and mnemonic instructions can be printed or displayed on your terminal. Large object programs can be segmented into small source files. M69RS \$ 50.00

ANNOUNCING TWO NEW M6809 DEVELOPMENT TOOLS

CROSSBAK—A 6809 TO 6800 CROSS MACROASSEMBLER that runs on your M6809 development system to produce relocatable M6800 object code. Has all features of M69RR (see above). Includes 6800 Linking Loader. M69CX \$200.00

CROSSGEN—A 6800 OBJECT CODE DISASSEMBLER/SOURCE GENERATOR that runs on your M6809 development system. Has all features of M69RS (see above). An invaluable tool for converting all 6800 object files over to the M6809. M69CS \$ 75.00

All programs are relocatable and come complete with Linking Loader, Programmer's Guide and extensively commented assembly listing. Available on 300 Baud cassette or mini-floppy disk. For disk, specify SSB or FLEX. Source Text input/output is TSC/SSB editor/assembler compatible.

Order directly by check or MC/Visa. California residents add 6% sales tax. Customers outside of U.S. or Canada add \$5 for air postage & handling.

Dealer inquiries welcome. FLEX is a trademark of TSC

Ed Smith's **SOFTWARE WORKS**
P.O. Box 339, Redondo Beach, CA 90277, (213) 373-3350

New Robotype™

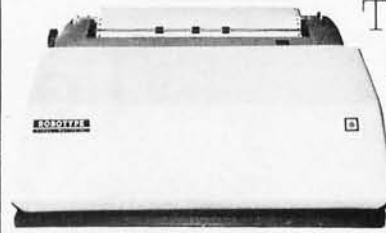

Turns your
typewriter
into a
quality
output
printer!

- easily connects to any computer
- serial and parallel interface
- all electronics included—ready to use from package
- connects to IBM Selectric II typewriter in just one minute
- adapts to a variety of typewriters—no modifications
- compatible with Radio Shack TRS-80, Apple II, Pet, etc.
- Centronics interface compatible
- available from stock in 30 days

Put a Robotype to work on your typewriter for under \$1,000. Call (614) 436-3163 today!

Dealer, distributors, and word processor OEM inquiries welcome.



Robotype™

(A trademark of Compu-Matics, Inc.)

Applied
Computer
Systems, Inc.



77 East Wilson Bridge Road • Worthington, Ohio 43085

MetaFloppy™ goes beyond.

The Micropolis MetaFloppy™ gives you more than four times the capacity of anyone else's 5¼-inch floppy. Because it uses 77 tracks instead of the usual 35.

The field-proven MetaFloppy, with thousands of units delivered, comes in a complete family of models. And, like our MacroFloppy™ family of disk drives, MetaFloppy is designed for the S-100/8080/Z-80 bus.

For maximum capacity, choose our new MetaFloppy:1054 system. Which actually provides you with more than a million bytes of reliable on-line storage. For less money than you'd believe possible.

The MetaFloppy:1054 comes complete with four drives in dual configuration. A controller. Power supply. Chassis. Enclosure. All cabling. A new BASIC software package. And a DOS with assembler and editor. There's even a built-in Autoload ROM to eliminate tiresome button pushing.

If that's more storage than you need right now, try our MetaFloppy:1053, with 630,000 bytes on-line. Or our MetaFloppy:1043, with 315,000 bytes on-line. Either way, you can expand to over a million bytes on-line in easy stages, when you need to. Or want to.

In other words, if your application keeps growing, we've got you covered. With MetaFloppy.

The system that goes beyond the floppy.

For a descriptive brochure, in the U.S. call or write Micropolis Corporation, 7959 Deering Avenue, Canoga Park, California 91304. Phone (213) 703-1121.

Or better yet, see your local dealer.

MICROPOLIS™
More bytes in store for you.



To Err Is Human

GIGO (garbage in, garbage out) is an expression heard so often by programmers that it is accepted as truth and even offered as an excuse for poorly written programs. It is a truism that ought to be examined, especially in the area of human prepared input that is typed.

If the instructions in figure 1a are entered instead of the correct instructions of figure 1b, the great majority of microprocessor assemblers will be unable to locate any of the program symbols. This inability compels the user to go through the tedious process of calling an edit program, making corrections, calling the assembler, and trying once more to assemble the source code, hoping that no new errors have been introduced. This procedure can be very time consuming; it is always frustrating. An examination of how the errors are detected in a normal assembler

Roger A McGregor
6933 S Allison Way
Littleton CO 80123

or compiler may shed light on how an automated correction can be attempted.

Normally, after a symbol has been segregated from the source text, it is passed to a symbol table lookup routine as a search argument. The function of the lookup routine is to find an entry in the symbol table whose symbol matches the search argument, and to either return that entry (a hit) or set some indicator to inform the calling routine of an unsuccessful search (a no-hit). Both hits and no hits are valid returns, depending on the pass being made on the source code.

The first pass causes two types of lookup calls; *definition* and *reference*. For a definition lookup, a symbol has been extracted from the label field. That symbol and its attributes are to be entered into the symbol table if and only if the symbol is not already present in the symbol table. However, if the symbol is already present, it is multiply defined and in error. For a reference lookup, a symbol found in the operand field is needed for a compile time computation (line 5 of figure 1b). For this lookup, the symbol must be present in the symbol table or an error condition exists.

During any other pass, a no-hit constitutes an error. It is at this point that error correction may be attempted in the form of an alternate (associated) symbol lookup.

If the lookup routine can find another symbol in the symbol table that is "close enough" to the search argument, then the entry's symbol is associated with the argument symbol and may be returned as a hit. When an alternate symbol is substituted in this fashion, the programmer must be given a warning as the substitution may not be correct. By checking the object code generated, the programmer can verify the substitution.

What constitutes "close enough" before a symbol table entry can be substituted for the search argument?

Label	Operation	Operand
1 LOOP	CPY	SPAEC
2	JSR	PRJNT
3	CMP	STRE
4	BEQ	LOOPS
5 COPY	EUQ	LOOP

Figure 1a: A section of code which illustrates several common typing errors often made during entry of an assembly program. These particular errors can be detected and corrected by a simple algorithm which determines if the operand is "close enough" to what it is supposed to be. If the operand has two transposed letters, one character wrong, or one character too many or too few, it is automatically changed to the correct form listed in the symbol table.

Label	Operation	Operand
1 LOOP	CPY	SPACE
2	JSR	PRINT
3	CMP	STORE
4	BEQ	LOOP
5 COPY	EQU	LOOP

Figure 1b: The code from figure 1a after error detection and correction.

About the Author

Roger McGregor works as a systems programmer on a large IBM system. He has written or worked on many operating systems, assemblers, compilers, and interpreters, and has successfully used the techniques presented here in an assembler.

"Close enough" is defined as two characters transposed (line 1, figure 1a), one character wrong (line 2, figure 1a), one missing character (line 3, figure 1a), or an extra character (line 4, figure 1a).

Given the above criteria, only certain symbols in the symbol table need be reexamined. Those symbols are the ones possessing an equal number of characters, or one more or one less character than the search argument. An exception occurs when the search argument consists of only a single character: if this happens, error correction should be terminated and a no-hit returned. Those symbols with an equal number of characters should be compared for transposed characters or one wrong character in the string. Those symbols with one more or one less character than the search argument should be checked for a single character difference. If any symbol in the symbol table passes one of the above tests, an association has occurred and the associated entry should be returned as a hit.

Generally, making a single pass through the symbol table and returning the first entry passing a check is sufficient. However, if the keyboard layout is more conducive to wrong characters due to upper and lower case shifting than to the other common errors of transposition, addition, or deletion, then a first pass through the symbol table checking only equal character count symbols for wrong characters could prove to be more accurate. Alternate strategies do however increase memory usage and execution time. The execution time is well spent if a proper association prevents the edit and reassemble process already described. Memory usage is another matter. The less memory used by the correction routine, the better.

Besides alleviating reassembly problems, the error correction process tends to encourage better documented programs. Due to the nature of the checks made for the association, longer symbols have a better chance of being correctly associated. They are also usually more meaningful.

The above correction process is by no means limited to just the symbol table of an assembler and compiler. It can be applied to any dictionary type lookup including op codes, text processors, and console commands.

The only obvious limitation would occur when symbols intentionally differ by a transposition or length. In order to overcome this objection, we simply require an explicit declaration statement and correct spelling in such statements with the extended error correction applied to uses of a name. ■

Baud News

Published by Datasouth Computer Corporation, 627-F Minuet Lane, Charlotte, NC 28210.

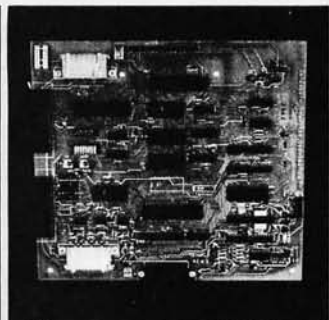

For LA36 Owners, 1200 Baud Breakthrough

CHARLOTTE A spokesman for Datasouth Computer Corp. confirmed reports of LA36 DECwriters® printing at blazing speed. With Datasouth's DS120 Terminal Controller, the LA36 prints bidirectionally at speeds up to 165 cps with true 1200 baud throughput. A 1000 character internal print buffer eliminates the need for fill characters.

is fully compatible with existing electronics.

Results Are In

As BAUD NEWS went to press, DS120's were providing enhanced speed and versatility for more than 3000 LA36 owners. The micro-processor-based electronics have proven very reliable, and service, when needed, has been prompt and efficient. Of course, the DS120 comes with a 90-day warranty on materials and workmanship.

Delivered Nationwide

Datasouth reports a network of stocking distributors in major cities throughout the U.S. for prompt service and delivery. The spokesman added that he welcomes inquiries and will gladly give you all the details on the DS120. He can be called at 704/523-8500 or addressed at Datasouth's office, 627-F Minuet Lane, Charlotte, N.C. 28210.

Well-Endowed With Features

Versatile performance features include complete forms control and data formatting capability programmable from either the keyboard or data stream; plus both an EIA RS232-C and 20mA Current Loop interface.

Easy Installation

This blazing speed is accomplished by replacing the LA36 logic card with the DS120 unit—which

DEC is a registered trademark of Digital Equipment Corporation.
Installation of the DS-120 will void any DEC warranty or service contract.

```

10 DIM$(256),S(64),W(3,76),T(76),N(6,64),P(4),V(64)
20 C1$="0123456789"\P(0)=22\P(1)=147\P(2)=1030\P(3)=2\P(4)=3
30 OPEN#0,"A16"\LINE#0
40 FORA=1T076\READ#0,W(0,A),W(1,A),W(2,A),W(3,A)\NEXT\FORA=1T064
50 READ#0,N(0,A),N(1,A),N(2,A),N(3,A),N(4,A),N(5,A),N(6,A)\NEXT
60 CLOSE#0\INPUT*0 TO 9 : 0 I PLAY BEST AND 9 WORST ? *,ZV=1+(Z/10)
100 FORA=1T064\B=A*4\C$(B-3,B)="          "\C=INT(A/10)\D=A-(C*10)
110 C$(B-1,B-1)=C1$(C+1,C+1)\C$(B,B)=C1$(D+1,D+1)\NEXT
120!"HERE IS MY BOARD"!*\GOSUB1000!*\!"!ENTER MOVES BY*,
130!" NUMBER AND YOUR'RE X"
140!"*\INPUT*YOUR MOVE ? *,X\IFX<10RX>64THEN140\IFS(X)<>0THEN140
150 S(X)=1\A=X*4\C$(A-3,A)="XXXX"\P=1\GOSUB900
160 Q=0\FORA=1T076STEPZ\C=T(A)\IFC<0THEN200\IFC=15THENEXIT400
170 IFC<>0THEN180\B=1\GOSUB500\GOTO200
180 IFC>4THEN190\B=P(C-1)\GOSUB500\GOTO200
190 C=INT(C/5)+2\B=P(C)\GOSUB500
200 NEXT\FORA=1T064\IFV(A)<0THEN210\Q=V(A)\X=A
210 V(A)=0\NEXT\IFQ=0ANDZ=1THEN1600\IFQ<0THEN220
215 FORA=1T064\IFS(A)=0THENEXIT217\NEXT\GOTO1600
217 S(A)=1\X=A
220 S(X)=1\A=X*4\C$(A-3,A)="0000"\P=5\GOSUB900
230!"I WENT*,X!*\GOSUB1000\GOTO140
400!"THE COMPUTER WINS WITH BOXES*,W(0,A),W(1,A),W(2,A),W(3,A)\GOTO2000
500 FORF=0T03\G=W(F,A)\IFS(G)=0THENV(G)=V(G)+B\NEXT\RETURN
900 FORA=0T06\C=N(A,X)\IFC=0THEN950\IFT(C)<0THEN950
910 T(C)=T(C)+P\IFT(C)<4THEN950\IFT(C)=4THENEXIT1700
920 D=INT(T(C)/5)\IFD*5<T(C)THEN(T(C))=-1
950 NEXT\RETURN
1000 FORA=0T03\FORB=2T00STEP-2\FORC=0T03\FORD=1T04
1010 E=((C*16)+D+(A*4))*4-B\C$(E-1,E)\IFD<4THEN!* = *,
1020 NEXT\IFC<3THEN!* *,\NEXT!\!"*\NEXT\IFA=3THEN1040
1030 FORE=1T03!\!===== *,\NEXT!\!=====
1040 NEXT\RETURN
1600!"*\!"IT'S A DRAW"\GOTO2000
1700!"*\F=C\GOSUB1000!*\C=F!\*YOU WON*,W(0,C),W(1,C),W(2,C),W(3,C)
2000 INPUT*CARRIAGE RETURN ENDS, ANYTHING ELSE PLAYS AGAIN ? *,Z$
2005 IFZ$="*THENEND\FORA=1T076\T(A)=0\NEXT\FORA=1T064\S(A)=0\V(A)=0\NEXT
2010 GOTO100
READY

```

Listing 1: Super TIC, a three-dimensional tic-tac-toe computer game written in North Star BASIC. (All other programs in this article are also written in North Star BASIC.)

Super TIC

J Roehrig
POB 74
Middle Village NY 11379

Listing 2: Modifications to listing 1 to change the three-dimensional version into two-dimensional 4 by 4 tic-tac-toe.

```

140!"*\INPUT*YOUR MOVE ? *,X\IFX<10RX>16THEN140\IFS(X)<>0THEN140
160 Q=0\FORA=1T010STEPZ\C=T(A)\IFC<0THEN200\IFC=15THENEXIT400
1000 FORA=0T03\FORB=2T00STEP-2\FORC=0T00\FORD=1T04
1030!"=====

```

Super Micro-Tic

This article describes Super TIC, a program that plays three-dimensional (4 by 4 by 4) tic-tac-toe. It was written specifically for microprocessors and has the following features:

- It is fast, despite the fact that it checks every possible move. The response time is 13 seconds per move (worst case) using an IMSAI 8080 computer with North Star BASIC, and it averages less than six seconds per move.

- It gives a graphic display of the game (designed for a 24 line by 80 character terminal) without requiring a graphics board.
- It plays at ten different levels of skill without requiring modification of the program.
- One program line can be modified to change the program's strategy so that it plays defensively or aggressively.
- The modification of four lines (see listing 2) allows the game to be played in a two-dimensional 4 by 4 format.

Listing 3 shows a sample run of the 4 by 4 by 4 version. The computer asks for the level of play desired and gives a display of the game board. The player enters a move selection (a number from 1 to 64 corresponding to the desired box) and the computer answers with its move. Next, the

SORCERER* SOFTWARE!

All programs on cassette. Only 8k of memory required.

new! TANK TRAP by Don Ursem. A rampaging tank tries to run you down. You try to trap it by building concrete walls around it. Four levels of play. **\$11.95**

new! Inquire about our **SMART TERMINAL** program.

PLOT by Vic Tolomei. Now Apple owners will be envious of how easy you can get good graphics on your SORCERER. PLOT includes both a super high resolution mode and a quick low resolution mode. Both are accessible from your BASIC programs using simple commands. Hi-res & lo-res examples included on tape. **\$14.95**

SHAPE MAKER™ by Don Ursem. Construct special characters and fancy shapes with ease using this on-screen character editor. Detailed 12-page instruction booklet includes example applications. **\$14.95**

DEBUG by Bob Pierce. Debug machine language programs by stepping through one instruction at a time. Relocatable. Several display options. Multiple break points. Modify memory and registers. **\$14.95**

Z-80 DISASSEMBLER by Vic Tolomei. Decode machine language programs, including SORCERER's monitor and ROM-PAC's, with this Z-80 Disassembler written in BASIC. Prints out machine code, Zilog mnemonics, and ASCII. **\$14.95**

FASTGAMMON™ by Bob Christiansen. A fast backgammon opponent. **\$19.95**

MAGIC MAZE™ by Vic Tolomei. A challenging maze game. **\$11.95**

SOFTWARE INTERNALS MANUAL FOR THE SORCERER by Vic Tolomei. A must for anyone writing software for the SORCERER. Seven chapters. Indexed. Includes diagrams and software routines. 64 pages. **\$14.95**

QS QUALITY SOFTWARE
6660 Reseda Blvd., Suite 103, Reseda, CA. 91335
Telephone 24 hours, seven days a week: (213) 344-6599

WHERE TO GET IT: Ask your nearest Sorcerer dealer to see Quality Software's Sorcerer programs. Or, if you prefer, you may order directly from us. MasterCard and Visa cardholders may telephone their orders and we will deduct \$1 from orders over \$19 to compensate for phone charges. Or mail your order to the address above. California residents add 6% sales tax. Orders outside North America add \$5 for registered airmail, pay in U.S. currency.

*The name "SORCERER" has been trademarked by Exidy, Inc.

CCS

CORPORATE COMPUTER SYSTEMS, INC.
675 Line Road, Aberdeen, New Jersey 07747 Telephone 201-583-4422



THE PROGRAMMING LANGUAGE HEWLETT PACKARD 1000 USERS HAVE BEEN WAITING FOR.

- Interfaces to the complete HP1000 software base
- Machine control found previously only in assembly language
- Easily supports Structured Programming
- Includes the portable I/O Library with Printf and Scanf
- Macro-prepass
- Compiles on the HP RTE-IV
- Allows embedded assembler

NEW FROM RACET COMPUTES DISK SORT MERGE 'DSM' FOR MOD I AND MOD II** TRS-80™

FAST — Now you can sort an 85K diskette in less than 3 minutes* **— FAST**

Perfect for your multi-diskette RANDOM file mailing lists, inventory, etc. Ideal for specialized report generation, sort, merge or combination. All machine language stand-alone package — Efficient and easy to use. No separate key files required! Physical records are rearranged on diskette! Supports multiple sub records per sector including optional sector spanning. Sorts on one or more fields — ascending or descending. Sort fields within records may be character, integer, and floating-point binary. Provides optional output field deletion, rearrangement, and padding.

*Sort timings shown below are nominal times. Times will vary based on sort and system configurations. Nominal times based on Mod I 48K 4-drive configuration, 64 byte records, and 5 sort keys.

TYPE	FILE SIZE	SORT TIME	TYPE	FILE SIZE	SORT TIME
	(Bytes)	(Sec)		(Bytes)	(Sec)
SORT	16K	33	SORT	340K	1081
SORT	32K	49	SORT	680K	2569
SORT	85K	173	SORT and MERGE	85K SORT + 1275K Merge	1757
SORT	170K	445			

DSM for Mod I (Minimum 32K, 2-drives) \$75 On-Disk
DSM for Mod II (Minimum 64K, 1-drive) \$150 On-Disk**

Mod II Development Package \$100**

Machine Language SUPERZAP, plus Editor/Assembler and Disassembler patches.

Mod II Generalized Subroutine Facility 'GSF' \$50**

**For Mod II Programs, Include Mod II DOS diskette with order For Development Package, also include copy of Apparatus NEWDOS + 5 1/4 diskette.

CHECK, VISA, M/C, C.O.D.

Calif. Residents add 6%

Telephone Orders Accepted (714) 637-5016

WHEN ORDERING PLEASE ADVISE PUBLICATION SOURCE

∞ **BASIC for Level II and Disk Systems \$49.95**
Full MATRIX Functions — 30 BASIC commands!!
Mathematical and common matrix functions. Change arrays in mid-program. Complete array handling. Tape array read and write, including strings. Common subroutine calls.

Over 50 more STRING Functions as BASIC commands!! String manipulation, translation, compression, copying, search, screen control, pointer manipulation and utility functions. Includes multikey multivariable machine language sorts. Load only machine language functions that you want! Where you want in memory! Relocating linking loader! More than you ever expected!!

∞ **BUSINESS (Requires Infinite BASIC) \$29.95**
20 Business oriented functions including:
Printer Automatic Pagination with headers and footers!
Packed Decimal Arithmetic (+, -, *, /) 127 digits!
Binary array searches and hash code generator!

COMPROC Command Processor for Disk Systems \$19.95
Auto your disk to perform any sequence of DOS commands, machine language loads, BASIC, memory size, run program, respond to input statements, etc. Single BASIC command file defines execution! Includes auto key-debounce, screen print and lower case software driver.

REMODEL + PROLOAD Specify 16, 32, or 48K Memory \$34.95
RNumber any portion or all of BASIC program. Move any portion of program from one location to another. DELETE program lines. MERGE all or any portion from tape. Save and verify portion or all of combined merged programs to tape.

GSF (Specify 16, 32, or 48K) \$24.95
18 Machine language routines. Includes RACET sorts.

TRS-80 IS A REGISTERED TRADEMARK OF TANDY CORPORATION

RACET COMPUTES
702 Palmdale, Orange CA 92665

entire game board is reprinted with the player's boxes represented by Xs and the computer's boxes by Os.

For those readers not familiar with three-dimensional tic-tac-toe, table 1 shows all of the 76 possible winning combinations. The

Table 1: The 76 possible ways to win in 4 by 4 by 4 three-dimensional tic-tac-toe. The columns labelled M1, M2, M3 and M4 given an integer identification of a particular cube in the three-dimensional 4 by 4 by 4 matrix.

COMB	M1	M2	M3	M4	COMB	M1	M2	M3	M4
1	1	2	3	4	2	5	6	7	8
3	9	10	11	12	4	13	14	15	16
5	1	5	9	13	6	2	6	10	14
7	3	7	11	15	8	4	8	12	16
9	1	6	11	16	10	4	7	10	13
11	17	18	19	20	12	21	22	23	24
13	25	26	27	28	14	29	30	31	32
15	17	21	25	29	16	18	22	26	30
17	19	23	27	31	18	20	24	28	32
19	17	22	27	32	20	20	23	26	29
21	33	34	35	36	22	37	38	39	40
23	41	42	43	44	24	45	46	47	48
25	33	37	41	45	26	34	38	42	46
27	35	39	43	47	28	36	40	44	48
29	33	38	43	48	30	36	39	42	45
31	49	50	51	52	32	53	54	55	56
33	57	58	59	60	34	61	62	63	64
35	49	53	57	61	36	50	54	58	62
37	51	55	59	63	38	52	56	60	64
39	49	54	59	64	40	52	55	58	61
41	1	17	33	49	42	2	18	34	50
43	3	19	35	51	44	4	20	36	52
45	5	21	37	53	46	6	22	38	54
47	7	23	39	55	48	8	24	40	56
49	9	25	41	57	50	10	26	42	58
51	11	27	43	59	52	12	28	44	60
53	13	29	45	61	54	14	30	46	62
55	15	31	47	63	56	16	32	48	64
57	1	22	43	64	58	5	22	39	56
59	9	26	43	60	60	13	26	39	52
61	2	22	42	62	62	14	26	38	50
63	3	23	43	63	64	15	27	39	51
65	4	23	42	61	66	8	23	38	53
67	12	27	42	57	68	16	27	38	49
69	1	21	41	61	70	1	18	35	52
71	4	19	34	49	72	4	24	44	64
73	13	25	37	49	74	13	30	47	64
75	16	31	46	61	76	16	28	40	52

first player to occupy 4 squares (or, more properly, "cubes") in a straight line wins. Note that there are ten ways to win on each of the four boards (four horizontal, four vertical and two diagonal) and 36 ways to win by occupying one adjoining square on each of the separate boards.

For comparison of strategies, the tic-tac-toe program, written by R K Loudon ("TTT3D" in *Programming the IBM 1130 and 1800*, Prentice-Hall, 1967), keeps totalling values for the 76 winning combinations after each move, tests for only three or four critical situations and always examines the 64 squares for vacant positions. The use of this technique would take a few minutes for each move using a microcomputer, and the program is considerably longer.

The key to writing a program efficient enough to operate on a microcomputer is to limit the number of operations performed. Instead of constantly totalling winning combinations after each move, a running total is maintained in Super TIC. The importance of winning combination totals is simple. A 0 is assigned to blank squares, a 1 to squares with Xs and a 5 to squares with Os. A winning combination totalling 0 represents a line that either player can still win with; a combination value less than 5 and greater than 0 is a combination in which only X can win; a combination total evenly divisible by 5 represents a possible O win; and all other values are blocked (no one can win) combinations. This same totalling method shows how many Xs or Os occupy the four squares of the winning combinations.

In order to make Super TIC execute quickly, only the 76 winning combinations are checked to determine the computer's

Listing 3: Sample printout of the beginning of Super TIC.

```

0 TO 9 : 0 I PLAY BEST AND 9 WORST ? 0
HERE IS MY BOARD

 01 = 02 = 03 = 04    17 = 18 = 19 = 20    33 = 34 = 35 = 36    49 = 50 = 51 = 52
=====
 05 = 06 = 07 = 08    21 = 22 = 23 = 24    37 = 38 = 39 = 40    53 = 54 = 55 = 56
=====
 09 = 10 = 11 = 12    25 = 26 = 27 = 28    41 = 42 = 43 = 44    57 = 58 = 59 = 60
=====
 13 = 14 = 15 = 16    29 = 30 = 31 = 32    45 = 46 = 47 = 48    61 = 62 = 63 = 64

ENTER MOVES BY NUMBER AND YOUR'RE X

YOUR MOVE ? 1
I WENT 64

XX = 02 = 03 = 04    17 = 18 = 19 = 20    33 = 34 = 35 = 36    49 = 50 = 51 = 52
=====
 05 = 06 = 07 = 08    21 = 22 = 23 = 24    37 = 38 = 39 = 40    53 = 54 = 55 = 56
=====
 09 = 10 = 11 = 12    25 = 26 = 27 = 28    41 = 42 = 43 = 44    57 = 58 = 59 = 60
=====
 13 = 14 = 15 = 16    29 = 30 = 31 = 32    45 = 46 = 47 = 48    61 = 62 = 63 = 00

YOUR MOVE ?

```

Buy By Mail and Save!

COMPUTERS

Intertec SuperBrain
 32K RAM \$2995 . . . \$2495
 64K RAM \$3345 . . . \$2695

NORTH STAR Horizon 1
 32K Kit, List \$1999 . . \$1579
 32K Assembled \$2695 . \$2149

Horizon 2
 32K DD, Kit, \$2399 . \$1885
 32K DD, Assm. \$3095 . \$2439
 32K QD, Kit \$3595 . \$2859
 32K QD, Assm. \$3595 . \$2859

CROMEMCO

System 3, 64K, \$6990 . \$5479
 System 2, 64K, \$3990 . \$3390

HEATH WH-89 \$1949

DISK SYSTEMS

THINKER TOYS

Discus 2D \$1149 \$939
 DISCUS 2+2 \$1549 . . \$1288

Most items in stock for immediate delivery, factory-sealed cartons, with full factory warranty. N.Y.S. residents add appropriate sales tax. Prices do not include shipping. VISA and Master Charge add 3%. COD orders require 25% deposit. Prices subject to change and offers subject to withdrawal without notice.

Computers Wholesale



P.O. Box 144
 Camillus, NY 13031
 (315) 472-2582



PRINTERS/TERMINALS

ANADEX DP-8000 \$ 869

HAZELTINE
 1410 \$739
 1420 \$839
 1500 \$989

INTERTUBE II
 List \$995 \$729

PERKIN-ELMER
 Bantam 550 \$789
 Televideo 912 \$789

CENTRONICS
 730-1 \$799
 779-1 Friction Feed . . \$939
 779-2 w/Tractor \$989
 702 w/Tractor, VFU
 \$2480 \$1990
 703 w/Tractor \$2975 . \$2175
 704 w/Tractor \$2350 . \$1995

DEC LA-34 \$1139
TELETYPE 43 \$ 989
T.I. 810 \$1575

RAM CHIPS

4044 TYPE

4K by 1 — 18-pin — 5V, 5% supply

These are the same factory prime chips used in our premium quality memory boards. May be 4044, 4041, 5257, 6641, or 9044, depending on manufacturer. All have 4044 pinout and timing specs. All guaranteed 30 days.

	250 nsec.	450 nsec.
1-9 chips	\$7.50	\$6.50
10-49	6.00	5.25
50-99	5.50	4.75
100-499	5.25	4.50
500-999	5.00	4.25
1000-up	call	call



Seattle Computer Products, Inc.

1114 Industry Drive, Seattle, WA. 98188
 (206) 575-1830

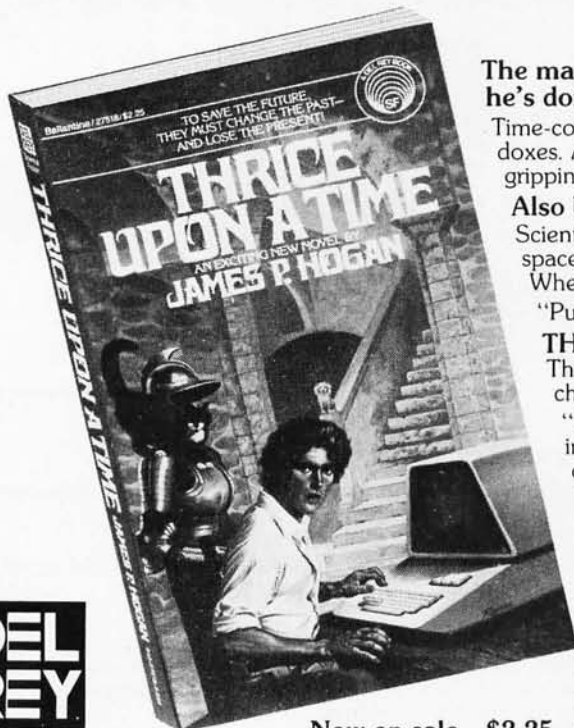

Now on sale—\$2.25



#1 PUBLISHER OF SCIENCE FICTION AND FANTASY.

Where paperbacks are sold or write to: **Ballantine Books**
 Dept. AL, 201 East 50th St., New York, N.Y. 10022.

JAMES P. HOGAN

The man who has put the science back into science fiction—now he's done it again with **THRICE UPON A TIME**.

Time-communication isn't exactly time-travel; but it creates the same paradoxes. And for scientist Murdoch Ross, there are no easy solutions. A gripping novel of time, probability—and destiny.

Also by Hogan: INHERIT THE STARS

Scientists had finally found a Man in the Moon...but he was wearing a space suit, was fully human and had been there for 50,000 years: Where did he come from and how did he get there?

"Pure science fiction...Arthur Clarke move over!"—Isaac Asimov

THE GENESIS MACHINE

The revolutionary unified field theory held all the answers—and a choice for man between destruction and vast new frontiers.

"Most theories in science fiction are mere wishful thinking. Hogan invents a theory that might really work."—Marvin Minsky, Professor of Science, MIT.

THE TWO FACES OF TOMORROW

A super science thriller of the evolution of true machine intelligence that required a drastic stimulus and produced a unique entity with unexpected responses.

Please send me _____ copies of **THRICE UPON A TIME** (27518-7) at \$2.25 each, _____ **INHERIT THE STARS** (28907-2) at \$1.95 each, _____ **THE GENESIS MACHINE** (27231-5) at \$1.75 each, and _____ **TWO FACES OF TOMORROW** (27517-9) at \$1.95 each. Enclosed is a check for _____ plus 50¢ per book to cover postage and handling. (Add sales tax where applicable.) **B**

Name _____

Address _____

City _____ State _____ Zip _____

Combination	Variable	Value (Defensive Version)	Value (Aggressive Version)
All Blanks		1	1
One X	P(0)	22	7
Two Xs	P(1)	147	22
Three Xs	P(2)	1030	147
One O	P(3)	2	2
Two Os	P(4)	3	3
All Others	—	0	0

NOTE: The computer is O and the values described are used to determine the computer's move. A value for three Os is not needed, since the computer will select that as its winning move without additional evaluation.

Table 2: Values assigned to squares under consideration. Each time a combination of four squares is checked by the program, these values are assigned to blank squares depending upon the nearest neighbors forming the best partial pattern combination listed.

NUM	C1	C2	C3	C4	C5	C6	C7	NUM	C1	C2	C3	C4	C5	C6	C7
1	1	5	9	41	57	69	70	2	1	6	42	61	0	0	0
3	1	7	43	63	0	0	0	4	1	8	10	44	65	71	72
5	2	5	45	58	0	0	0	6	2	6	9	46	0	0	0
7	2	7	10	47	0	0	0	8	2	8	48	66	0	0	0
9	3	5	49	59	0	0	0	10	3	6	10	50	0	0	0
11	3	7	9	51	0	0	0	12	3	8	52	67	0	0	0
13	4	5	10	53	60	73	74	14	4	6	54	62	0	0	0
15	4	7	55	64	0	0	0	16	4	8	9	56	68	75	76
17	11	15	19	41	0	0	0	18	11	16	42	70	0	0	0
19	11	17	43	71	0	0	0	20	11	18	20	44	0	0	0
21	12	15	45	69	0	0	0	22	12	16	19	46	57	58	61
23	12	17	20	47	63	65	66	24	12	18	48	72	0	0	0
25	13	15	49	73	0	0	0	26	13	16	20	50	59	60	62
27	13	17	19	51	64	67	68	28	13	18	52	76	0	0	0
29	14	15	20	53	0	0	0	30	14	16	54	74	0	0	0
31	14	17	55	75	0	0	0	32	14	18	19	56	0	0	0
33	21	25	29	41	0	0	0	34	21	26	42	71	0	0	0
35	21	27	43	70	0	0	0	36	21	28	30	44	0	0	0
37	22	25	45	73	0	0	0	38	22	26	29	46	62	66	68
39	22	27	30	47	58	60	64	40	22	28	48	76	0	0	0
41	23	25	49	69	0	0	0	42	23	26	30	50	61	65	67
43	23	27	29	51	57	59	63	44	23	28	52	72	0	0	0
45	24	25	30	53	0	0	0	46	24	26	54	75	0	0	0
47	24	27	55	74	0	0	0	48	24	28	29	56	0	0	0
49	31	35	39	41	68	71	73	50	31	36	42	62	0	0	0
51	31	37	43	64	0	0	0	52	31	38	40	44	60	70	76
53	32	35	45	66	0	0	0	54	32	36	39	46	0	0	0
55	32	37	40	47	0	0	0	56	32	38	48	58	0	0	0
57	33	35	49	67	0	0	0	58	33	36	40	50	0	0	0
59	33	37	39	51	0	0	0	60	33	38	52	59	0	0	0
61	34	35	40	53	65	69	75	62	34	36	54	61	0	0	0
63	34	37	55	63	0	0	0	64	34	38	39	56	57	72	74

Table 3: Winning combinations for each square. The 64 squares of the board are listed under NUM, to the right of which are the winning combination numbers involved with each square (see table 1). After each combination is examined, the value shown in table 2 is assigned to any blank square in the combination. These values are accumulated as each combination is evaluated. The square with the highest value becomes the computer's next move.

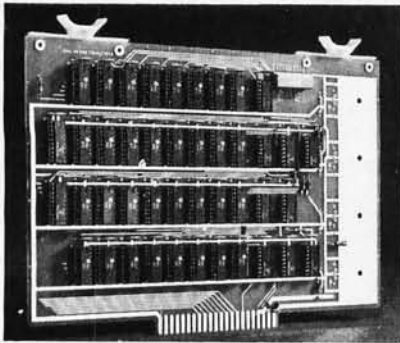

VAK-4 DUAL 8K-RAM ~~\$379.00~~ \$325.00 plus shipping
 VAK-2 8K-RAM (1/2 populated) \$239.00

VAK-4 16K STATIC RAM BOARD

- Designed specifically for use with the AIM-65, SYM-1, and KIM-1 microcomputers
- Two separately addressable 8K-blocks with write protect.
- Designed for use with the VAK-1 or KIM-4* motherboards
- Has provisions for mounting regulators for use with an unregulated power supply
- Made with 1st quality 2114 static ram chips
- All IC's are socketed
- Completely assembled, burned-in, and tested

We manufacture a complete line of high quality expansion boards. Use reader service card to be added to our mailing list, or U.S. residents send \$1.00 (International send \$3.00 U.S.) for airmail delivery of our complete catalog.

*Product of MOS Technology



2967 W. Fairmount Avenue • Phoenix, AZ 85017 • (602) 265-7564

move. Furthermore, once the combination is considered blocked (at least one X and at least one O in the four boxes making up the possible winning combination) a negative value is assigned and the combination is never checked again.

This leaves us with the problem of selecting a move. Each time a combination is checked, a value is assigned to the group of four squares making up the combination. These values are shown in table 2 for two possible versions of Super TIC, and are contained on line 20 of the program.

The next difficulty is determining which winning combinations are associated with each square. These values are calculated ahead of time using a short program and are read into the program as data. Table 3 shows the 64 game squares and which of the winning combinations use which particular squares (the winning combination numbers refer back to the combinations detailed in table 1). After each combination is examined, the value shown in table 2 is assigned to any blank square in the combination. These values are accumulated as each combination is evaluated. The square with the highest value becomes the computer's move.

In order to test the program as well as the different strategies, the program shown in listing 4 can be used to pit the computer against itself. The defensive game always plays itself to a draw. Note that line 35 in listing 4 adds a new variable Y(4) that gives a different strategy to be used for the player moving first when the computer plays against itself. To my surprise, the defensive version can be beaten.

As mentioned earlier, the game plays at ten different levels. Level 0 checks all 76 combinations, while level 9 checks only 40 combinations. Table 4 shows which levels check how many combinations and which specific combinations.

Listing 4: Program to enable the computer to play against itself in the game of Super TIC.

```

10 DIMC$(256),S(64),W(3,76),T(76),N(6,64),P(4),V(64)
15 DIMM(1,36)
20 C1$="0123456789\NP(0)=22\NP(1)=147\NP(2)=1030\NP(3)=2\NP(4)=3
30 OPEN#0,"A16"\LINE130
35 DIMY(4)\Y(0)=2\Y(1)=147\Y(2)=1030\Y(3)=2\Y(4)=3
40 FORA=1T076\READ#0,W(0,A),W(1,A),W(2,A),W(3,A)\NEXT\FORA=1T064
50 REAF#0,N(0,A),N(1,A),N(2,A),N(3,A),N(4,A),N(5,A),N(6,A)\NEXT
60 CLOSE#0Z=1
90 N(0,30)=14
100 FORA=1T064\B=A*4\C$(B-3,B)=" *C=INT(A/10)\D=A-(C*10)
110 C$(B-1,B-1)=C1$(C+1,C+1)\C$(B,B)=C1$(D+1,D+1)\NEXT
114 FORT9=1T064\X=T9\C9=1
115 !""\*GAME STARTED WITH",T9
141 GOTO150
145 GOTO660
150 S(X)=1\A=X*4\C$(A-3,A)="XXX*\P=1\GOSUB900
155 M(0,C9)=X
160 Q=0\FORA=1T076STEPZ\C=T(A)\IFC<0THEN200\IFC=15THENEXIT400
170 IFC<0THEN180\B=1\GOSUB500\GOTO200
180 IFC>4THEN190\B=P(C-1)\GOSUB500\GOTO200
190 C=INT(C/5)+2\B=P(C)\GOSUB500
200 NEXT\FORA=1T064\IFV(A)<0THEN210\Q=V(A)\X=A
210 V(A)=0\NEXT\IFQ=0THEN1900
220 S(X)=1\A=X*4\C$(A-3,A)="0000*\P=5\GOSUB900
230 M(1,C9)=X\C9=C9+1\GOTO145
400 !"THE COMPUTER WINS WITH BOXES",W(0,A),W(1,A),W(2,A),W(3,A)\GOTO2000
500 FORF=0T03\G=W(F,A)\IFS(G)=0THENV(G)=V(G)+B\NEXT\RETURN
660 Q=0\FORA=1T076STEPZ\C=T(A)\IFC<0THEN700\IFC=3THENEXIT400
670 IFC<0THEN680\B=1\GOSUB500\GOTO700
680 IFC<5THEN690\B=INT(C/5)\B=Y(B-1)\GOSUB500\GOTO700
690 B=Y(C+2)\GOSUB500
700 NEXT\FORA=1T064\IFV(A)<0THEN710\Q=V(A)\X=A
710 V(A)=0\NEXT\IFQ=0THEN1900
720 GOTO150
900 FORA=0T06\C=N(A,X)\IFC=0THEN950\IFT(C)<0THEN950
910 T(C)=T(C)+P\IFT(C)<4THEN950\IFT(C)=4THENEXIT1700
920 D=INT(T(C)/5)\IFD#5<>T(C)THEN(T(C))=-1
950 NEXT\RETURN
1000 RETURN
1700 !""\F=C\GOSUB1000\!""\C=F\*YOU WON",W(0,C),W(1,C),W(2,C),W(3,C)
1900 !""\*IT'S A DRAW"
2000 Z$=""
2005 IFZ$=""THENEND\FORA=1T076\T(A)=0\NEXT\FORA=1T064\S(A)=0\V(A)=0\NEXT
2020 !"PLAYER 1"\FORA=1T036\IFM(0,A)=0THENEXIT2030\!Z3I,M(0,A),\NEXT
2030 !""\*PLAYER 2"\FORA=1T036\IFM(1,A)=0THENEXIT2035\!Z3I,M(1,A),\NEXT
2035 !""\FORA=1T036\M(1,A)=0\M(0,A)=0\NEXT
2040 NEXTT9\END
READY
RUN

```

```

GAME STARTED WITH 1
THE COMPUTER WINS WITH BOXES 1 2 3 4
PLAYER 1
 1 61 52 49 25 47 60 16 4 42 38 22 19 36 26 2
PLAYER 2
 64 41 58 57 13 35 17 28 46 23 27 6 34 20 50 62
GAME STARTED WITH 2

```

SL5...A NEW PROGRAMMING SYSTEM FOR A NEW DECADE

James M Goldenberg
Silicon Valley OEM Corp.

March 1, 1979

Dear Jim:

We've done it. SL5 is ready for distribution, and its pure dynamite. I'm convinced it's the OEM programming system for the 80's. SL5 is a well structured(built-in recursion & CASE statements), stack oriented, interactive programming tool for small systems and is based on the 1977 Forth standard.

The execution speed is fast, our normal development system runs in 16K(32K to recompile everything), and the production code is very compact(2K- min!) thanks to our SYSGEN program which trims all the fat and can also create stand-alone (optionally rommable) modules. We are fully compatible with CP/M, with an 8080 version and a completely separate Z80 version available. Since SL5 is written in SL5, it easily adapts to other CPUs. The version for the Motorola 6809 is almost ready for release(let me know if you need some other CPU). The enhancement possibilities seem endless.

We have decided to keep our price low initially to get wider distribution. The \$150 single user license includes all source code and the manual. I know you've been doing a lot of development work with Z80s, and I think it's perfect for your programmers. I give you fair warning, though, once you've used SL5 there's no going back to BASIC, FORTRAN, PASCAL, or Assembler.

Sincerely,
Dave
Dave DeLauter

PS...See you the next time you're in the Midwest...Say hi to Janet & James Paul.

- CP/M COMPATIBLE

- 1977 FORTH SUPERSET

- 100 PAGE MANUAL

- SPECIAL Z80 VERSION

- \$150 SINGLE SYSTEM LICENSE

- ALL SOURCE CODE INCLUDED

- FAST COMPACT ROMMABLE CODE

PO Box 1596
324 E Kirkwood Avenue
Bloomington IN 47402
(317) 336-1680

the stackworks

COMB 0 1 2 3 4 5 6 7 8 9 COMB 0 1 2 3 4 5 6 7 8 9

Listing 5: Sample printout of two-dimensional version of Super TIC (see listing 2).

```

0 TO 9 : 0 I PLAY BEST AND 9 WORST ? 5
HERE IS MY BOARD

= = =
01 = 02 = 03 = 04
=====
= = =
05 = 06 = 07 = 08
=====
= = =
09 = 10 = 11 = 12
=====
= = =
13 = 14 = 15 = 16

ENTER MOVES BY NUMBER AND YOUR'RE X

YOUR MOVE ? 9
I WENT 5

= = =
01 = 02 = 03 = 04
=====
00 = = =
00 = 06 = 07 = 08
=====
XX = = =
XX = 10 = 11 = 12
=====
= = =
13 = 14 = 15 = 16

```

1	X	X	X	X	X	X	X	X	X		2	X	X	X	X	X	X	X	X	
3	X	X	X	X	X						4	X	X	X	X	X	X	X	X	
5	X	X	X	X	X						6	X	X	X	X					
7	X	X	X	X	X	X	X				8	X	X	X	X	X				
9	X	X	X	X	X	X	X				10	X	X	X	X	X	X	X	X	
11	X	X	X	X	X	X	X				12	X	X	X	X	X	X	X	X	
13	X	X	X	X	X	X	X				14	X	X	X	X	X	X	X	X	
15	X	X	X	X	X	X	X				15	X	X	X	X	X	X	X	X	
17	X	X	X	X	X	X	X				18	X	X	X	X	X	X	X	X	
19	X	X	X	X	X	X	X				20	X	X	X	X	X	X	X	X	
21	X	X	X	X	X	X	X				22	X	X	X	X	X	X	X	X	
23	X	X	X	X	X	X	X				24	X	X	X	X	X	X	X	X	
25	X	X	X	X	X	X	X				26	X	X	X	X	X	X	X	X	
27	X	X	X	X	X	X	X				28	X	X	X	X	X	X	X	X	
29	X	X	X	X	X	X	X				30	X	X	X	X	X	X	X	X	
31	X	X	X	X	X	X	X				32	X	X	X	X	X	X	X	X	
33	X	X	X	X	X	X	X				34	X	X	X	X	X	X	X	X	
35	X	X	X	X	X	X	X				36	X	X	X	X	X	X	X	X	
37	X	X	X	X	X	X	X				38	X	X	X	X	X	X	X	X	
39	X	X	X	X	X	X	X				40	X	X	X	X	X	X	X	X	
41	X	X	X	X	X	X	X				42	X	X	X	X	X	X	X	X	
43	X	X	X	X	X	X	X				44	X	X	X	X	X	X	X	X	
45	X	X	X	X	X	X	X				46	X	X	X	X	X	X	X	X	
47	X	X	X	X	X	X	X				48	X	X	X	X	X	X	X	X	
49	X	X	X	X	X	X	X				50	X	X	X	X	X	X	X	X	
51	X	X	X	X	X	X	X				52	X	X	X	X	X	X	X	X	
53	X	X	X	X	X	X	X				54	X	X	X	X	X	X	X	X	
55	X	X	X	X	X	X	X				56	X	X	X	X	X	X	X	X	
57	X	X	X	X	X	X	X				58	X	X	X	X	X	X	X	X	
59	X	X	X	X	X	X	X				60	X	X	X	X	X	X	X	X	
61	X	X	X	X	X	X	X				62	X	X	X	X	X	X	X	X	
63	X	X	X	X	X	X	X				64	X	X	X	X	X	X	X	X	
65	X	X	X	X	X	X	X				66	X	X	X	X	X	X	X	X	
67	X	X	X	X	X	X	X				68	X	X	X	X	X	X	X	X	
69	X	X	X	X	X	X	X				70	X	X	X	X	X	X	X	X	
71	X	X	X	X	X	X	X				72	X	X	X	X	X	X	X	X	
73	X	X	X	X	X	X	X				74	X	X	X	X	X	X	X	X	
75	X	X	X	X	X	X	X				76	X	X	X	X	X	X	X	X	

FOR LEVEL 0	:	1.000%	OR	76/76	OF	THE	COMBINATIONS	ARE	CHECKED
FOR LEVEL 1	:	.908%	OR	69/76	OF	THE	COMBINATIONS	ARE	CHECKED
FOR LEVEL 2	:	.829%	OR	63/76	OF	THE	COMBINATIONS	ARE	CHECKED
FOR LEVEL 3	:	.763%	OR	58/76	OF	THE	COMBINATIONS	ARE	CHECKED
FOR LEVEL 4	:	.711%	OR	54/76	OF	THE	COMBINATIONS	ARE	CHECKED
FOR LEVEL 5	:	.671%	OR	51/76	OF	THE	COMBINATIONS	ARE	CHECKED
FOR LEVEL 6	:	.618%	OR	47/76	OF	THE	COMBINATIONS	ARE	CHECKED
FOR LEVEL 7	:	.592%	OR	45/76	OF	THE	COMBINATIONS	ARE	CHECKED
FOR LEVEL 8	:	.553%	OR	42/76	OF	THE	COMBINATIONS	ARE	CHECKED
FOR LEVEL 9	:	.526%	OR	40/76	OF	THE	COMBINATIONS	ARE	CHECKED

Table 4: Winning combinations checked by each level of expertise in Super TIC. Level 0 is the most proficient level, level 9 the least. An X in the column for a given combination indicates that the given combination is to be checked.

Listing 6: Modifications to listing 1 to avoid the need for a disk data file.

```

30 LINEBO
40 FORA=1TO76\READW(0,A),W(1,A),W(2,A),W(3,A)\FORB=0TO3\C=W(B,A)
50 FORD=0TO6\IFN(D,C)=0THENEXIT$2\NEXT
52 N(D,C)=A\NEXT\NEXT
3000 DATA 1, 2, 3, 4, 5, 6, 7, 8, 9,10,11,12,13,14,15,16, 1, 5, 9,13
3010 DATA 2, 6,10,14, 3, 7,11,15, 4, 8,12,16, 1, 6,11,16, 4, 7,10,13
3020 DATA17,18,19,20,21,22,23,24,25,26,27,28,29,30,31,32,17,21,25,29
3030 DATA18,22,26,30,19,23,27,31,20,24,28,32,17,22,27,32,20,23,26,29
3040 DATA33,34,35,36,37,38,39,40,41,42,43,44,45,46,47,48,33,37,41,45
3050 DATA34,38,42,46,35,39,43,47,36,40,44,48,33,38,43,48,36,39,42,45
3060 DATA49,50,51,52,53,54,55,56,57,58,59,60,61,62,63,64,49,53,57,61
3070 DATA50,54,58,62,51,55,59,63,52,56,60,64,49,54,59,64,52,55,58,61
3080 DATA 1,17,33,49, 2,18,34,50, 3,19,35,51, 4,20,36,52, 5,21,37,53
3090 DATA 6,22,38,54, 7,23,39,55, 8,24,40,56, 9,25,41,57,10,26,42,58
3100 DATA11,27,43,59,12,28,44,60,13,29,45,61,14,30,46,62,15,31,47,63
3110 DATA16,32,48,64, 1,22,43,64, 5,22,39,56, 9,26,43,60,13,26,39,52
3120 DATA 2,22,42,62,14,26,38,50, 3,23,43,63,15,27,39,51, 4,23,42,61
3130 DATA 8,23,38,53,12,27,42,57,16,27,38,49, 1,21,41,61, 1,18,35,52
3140 DATA 4,19,34,49, 4,24,44,64,13,25,37,49,13,30,47,64,16,31,46,61
3150 DATA16,28,40,52
READY

```

A sample run of the 4 by 4 version is given in listing 5. Here level 5 was used and, according to table 4, combination 3 is not checked. Therefore, combination 3 was an easy winner.

The data read into Super TIC was taken from a disk file using conventions of North Star BASIC. In order to modify this, merely take out the open file statement (line 30) and add data statements. The file designation in the line 40 and line 50 read statements should also be removed. Listing 6 shows how this can be accomplished.

Super TIC, as presented, is almost unbeatable (I believe that it is impossible to write an unbeatable version as long as the player always goes first and the computer second). You could probably play for days and never do better than a draw. However, armed with the computer generated winning combination in listing 4, you can beat the computer easily by remembering 16 exact moves. ■



A Message to our Subscribers

From time to time we make the BYTE subscriber list available to other companies who wish to send our subscribers promotional material about their products. We take great care to screen these companies, choosing only those who are reputable, and whose products, services, or information we feel would be of interest to you. Direct mail is an efficient medium for presenting the latest personal computer goods and services to our subscribers.

Many BYTE subscribers appreciate this controlled use of our mailing list, and look forward to finding

information of interest to them in the mail. Used are our subscribers' names and addresses only (no other information we may have is ever given).

While we believe the distribution of this information is of benefit to our subscribers, we firmly respect the wishes of any subscriber who does not want to receive such promotional literature. Should you wish to restrict the use of your name, simply send your request to BYTE Publications Inc, Attn: Circulation Department, 70 Main St, Peterborough NH 03458. Thank you.

The New HP.85!



Hewlett-Packard's Personal Computer
for Professionals



10% off and a FREE
Applications Book (\$5 value)
with the purchase of a
Hewlett-Packard Series E
Calculator. Starting at \$45.

FULL LINE OF HP CALCULATORS  HEWLETT
PACKARD

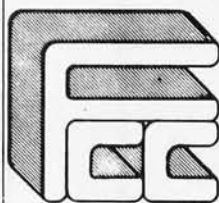

**FARNSWORTH
COMPUTER CENTER**

1891 N. FARNSWORTH AVE.
AURORA, IL. 60505

(312) 851-3888
Weekdays 10 to 8 - Sat. 10 to 5

SOFTWARE MUSIC SYNTHESIS SYSTEM

Written by John Bokelman, originator of the now unavailable Music System from Software Technology.



SMS is an integrated software system, and includes all required hardware. It turns any 8080/Z-80 or 8085 microcomputer into a high quality, multi-voice synthesizer. The software occupies less than 4K, with 8K being the minimum memory requirement.

The software is self-configuring to the hardware environment, no patching is required to select the I/O port address for the hardware interface nor to select the 2,3,4, or 5 mHz operation. Built-in diagnostics are provided to insure correct system installation.

Hardware requirements are: 8080, Z-80 or 8085 microcomputer; 2,3,4, or 5 mHz operation; one 8-bit parallel output port (any address); one 8-bit parallel input port optional (any address); no "wait state" memory; and a system monitor or operating system that looks like a standard CP/M, Northstar DOS or SOLOS/CUTER. The D/A Converter provided hooks to any parallel port, and therefore does not require S-100 slot.

The package will be available in those same three configurations. The CP/M version will run on any CP/M environment (includes CDOS, IMSAIDOS, etc.) and has its origin at 100H. The Northstar system will run on any Horizon or any non-relocated MDS system. It has origin at 2D00H. The SOLOS/CUTER system will run on any SOL or any CUTER system, and it has origin of 100H. All versions are designed to operate correctly in an interrupt driven environment.

The system has been designed to be *upwardly compatible with the now unavailable Proc Tech Music System*, so users of that system may run their programs with the new interpreter. The new interpreter has been dubbed Music Language #1 or ML/1 for short. The programs written for the old Music System will be greatly improved with the new system as the tones produced are much finer and more controllable.

ONLY \$79.95

The software includes a line oriented text editor, a high level music language compiler, a file management system and the advanced music synthesizer.

Ordering information: The price of the system on diskette or cassette with complete documentation and with the hardware kit and ten songs is \$79.95 (cables not included). Those interested in obtaining a system should order from California Software, Box 275, El Cerrito, CA 94530. Dealer inquiries are invited. *Specify CP/M, Northstar or Cuter.*

CALIFORNIA SOFTWARE CO.

CP/M is a trademark of Digital Research.

SURPLUS ELECTRONICS

ASCII

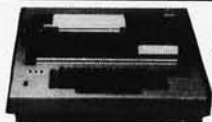

ASCII

IBM SELECTRIC[®] BASED I/O TERMINAL WITH ASCII CONVERSION INSTALLED \$645.00

- Tape Drives • Cable
 - Cassette Drives • Wire
 - Power Supplies 12V15A, 12V25A, 5V35A Others, • Displays
 - Cabinets • XFMRs • Heat Sinks • Printers • Components
- Many other items, SEND \$1.00 FOR CATALOG
REFUNDABLE FIRST ORDER
WORLDWIDE ELECT. INC.
130 Northeastern Blvd.
Nashua, NH 03060

Phone orders accepted using
VISA or MC
Call 603-889-7661

Circle 208 on inquiry card.

STATISTICAL DATA

DATABANK programs contain 10 years of monthly statistical data on ten related subjects. Information is the most current available. Each cassette is date stamped. Includes graphs, tables, trends, comparisons, update routine, and external input.

Programs available for **TRS-80** L2, 16K

- General Economy
- Manufacturing & Trade
- Industrial Production
- Money & Credit
- Money Rates & Yields
- Commodity Spot Prices
- Mortgage Terms & Yields
- Foreign Exchange Rates
- Energy Production
- Petroleum Production

\$29.95 each 3 for \$84.95
Cassette storage album included with order for six or more programs.

**DATABANK POB 030458
Ft Lauderdale, FL 33303**

Circle 209 on inquiry card.

Floppys & Systems Repair

DRIVES

- Per Sci - Shugart
- Pertec - Micropolis

COMPUTERS

- Apple - TRS-80

Computer Service Center
1023 N. La Brea
Hollywood, CA 90038
(213) 851-2226

Circle 210 on inquiry card.

Programming Quickies

The Towers of Hanoi Solution Using BASIC Recursion

Stanley Switzer, 1019 W 27th St, Lawrence KS 66044

The Towers of Hanoi is an intriguing puzzle of the Orient. The puzzle requires three vertical rods and a given number of disks with holes in the center to be placed on the rods. Initially, all of the disks are placed on the leftmost rod, arranged by size with the largest disk on the bottom (see figure 1). The objective is to move all of the disks to the rightmost rod. There are, however, a few restrictions. Only one disk may be moved at a time, and no disk may be placed over a disk smaller than itself. The solution to this puzzle may seem difficult at first, but with the help of a recursive program, it is simple.

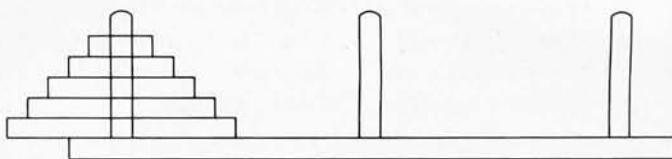

Figure 1: Initial configuration for the Towers of Hanoi problem. The objective is to move all the disks one at a time from the left rod to the right rod without ever placing a larger disk on top of a smaller disk. Intermediate moves can be made to the center rod, of course.

A recursive program is one that is defined in terms of itself. It is utilized when a problem can be broken into several parts, and when one of those parts is a similar problem of lesser magnitude. A common example is a definition of factorials:

$$0! = 1$$
$$n! = n(n-1)!$$

Here is a recursive program for factorials written in pseudocode:

```
factorial (n)
  if (n=0)
    return(1);
  else
    return(n × factorial(n - 1));
```

In this case an iterative definition is more practical for computational purposes, but this does illustrate the concept of recursion.

When broken into its basic parts, the solution to the Towers of Hanoi problem is as follows:

- When one disk is to be moved, the solution is ob-

**For Business Systems Software
Programmers Only!!
Machine Language
ISAM**

**FOR
TRS-80* Models I and II
ACCESS TIME ½ SECOND!!**

This machine language **ISAM ROUTINE** provides file access sophistication required to implement complex business software, and is completely compatible with **TRS-80* BASIC**.

Specifications: based on 1000 record file, key length of 6, data length of 64

Access time of ½ second
Best add/delete time of 1 second
Average add/delete time of 2 seconds
Worst case add/delete time of 5 seconds
Keys up to 25 characters
Data up to 255
Provides next highest key upon each file access.
Preset range of allowable key values, set upon file creation up to 4 files held open concurrently.
No special utilities needed to "Reclaim" used record space.
Model I Routine occupies 5 K of user space (loads at top of user memory)
Model II Routine occupies 6 K of user space (loads at top of user memory)
EOF, file full, empty, key not found, INVALID key value and all TRS DOS* error codes supported.

TRS-80 Model I (32 K + 48 K only) \$160.00
TRS-80 Model II (64 K only) \$170.00

Includes: All necessary documentation, file creation program, file inspection program, machine language ISAM routine and loader.



**SYSTEMS SPECIALISTS
415 MILLBURY STREET
WORCESTER, MA 01607
(617) 755-8134**

*TRS-80 and TRS DOS are trademark of Tandy Corporation, which has no relationship to RCR Inc.

**Model EP-2A-88
EPROM Programmer**

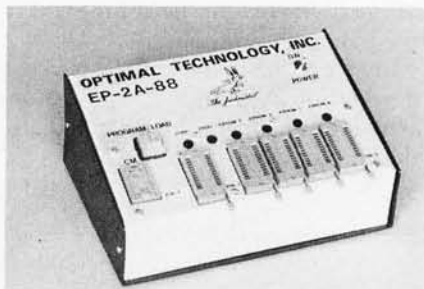

Fast as Jackrabbits . . . Well, almost!

In Australia, two rabbits can reproduce over 13 million offspring in 3 years . . . at 105 seconds per 2716, the EP-2A-88 can reproduce 1,892,160 EPROMS in 3 years. Single push button control, the EP-2A-88 checks if EPROMS are erased, programs and verifies. It also checks for defective EPROMS.

Two basic models are available, The EP-2A-88-1 will accept Copy (CM) modules for the 2758, and 2716 EPROMS. The EP-2A-88-2 will accept copy modules for the 2716, 2732 and TMS 2532 EPROMS. Power requirements are 115 VAC 50/60 Hertz at 15 watts.

Part No.	Description	Price
EP-2A-88-1	EPROM Programmer	\$450.00
EP-2A-88-2	EPROM Programmer	450.00
CM-50	Copy Module for 2716, TMS 2516 EPROMS	25.00
CM-70	Copy Module for 2758 EPROMS	25.00
CM-20	Copy Module for 2732 EPROMS	25.00
CM-40	Copy Module for TMS-2532 EPROMS	25.00
	Non-Standard Voltage Option (220 v, 240 v, 100 v)	15.00

Optimal Technology, Inc.
Blue Wood 127, Earlsville, Virginia 22936
Phone (804) 973-5482

PRESENTING

**THE MOST UNIQUE INFORMATION MANAGEMENT SYSTEM
YOU CAN BUY. NOT JUST A DATABASE MANAGER. EASILY
CREATE A COMPLETE, STAND-ALONE, MENU DRIVEN
APPLICATION IN HOURS**

THE CONFIGURABLE BUSINESS SYSTEM™

- No Programming Experience Necessary
- User Definable Records Up To 2K Bytes
- Powerful Report Generating Capabilities
- Built-in, Self-reorganizing ISAM File Structure
- Interactive and Batch Information Processing
- Packed Fields For Efficient Disk Utilization
- System Completely Menu Driven
- Fast Execution - All Programs in 8080/Z80 Machine Code
- Easily Configured to Your CRT
- Field Proven
- Comprehensive Users Guide
- Supplied On 2-8" CP/M* Compatible Disks

Dealer Inquiries Invited



*CP/M is a Trademark of Digital Research Corp.

Phone Orders Accepted
N.Y. Residents Add 7% Sales Tax

**DISKS AND MANUAL \$295.00
MANUAL ALONE . . . \$ 40.00**



**DYNAMIC
MICROPROCESSOR
ASSOCIATES**

36 Pinewood Drive
Commack, N.Y. 11725
(516) 543-6006

vious — move the disk from the source to the destination rod.

- When $n+1$ disks are to be moved:
 - 1) Move n disks from the source rod to the intermediate rod;
 - 2) Move one disk from the source rod to the destination rod; and
 - 3) Move n disks from the intermediate rod to the destination rod.

Listing 1: Recursive solution to the Towers of Hanoi problem in BASIC.

```

010 REM Declare the stack arrays.
020 DIM S$(15),D$(15),I$(15)
030 PRINT
040 PRINT "Number of disks";
050 INPUT P
060 REM If P is too large or too small, STOP.
070 IF (P > 15) THEN 170
080 IF (P < 1) THEN 170
090 REM Move P disks from Left to Right.
100 LET S$(P) = "L"
110 LET D$(P) = "R"
120 LET I$(P) = "C"
130 REM Move those disks!
140 GOSUB 180
150 REM Since that was so much fun let us do it again.
160 GOTO 30
170 STOP
180 REM This is the recursive HANOI procedure.
190 REM If P = 1, move one disk from source to destination.
200 IF (P > 1) THEN 230
210 PRINT "Move a disk from ";S$(P);" to ";D$(P);"."
220 RETURN
230 REM Else, move P - 1 disks from Source to Intermediate.
240 LET P = P - 1
250 LET S$(P) = S$(P + 1)
260 LET D$(P) = I$(P + 1)
270 LET I$(P) = D$(P + 1)
280 GOSUB 180
290 REM Move one disk from Source to Destination.
300 PRINT "Move a disk from ";S$(P + 1);" to ";D$(P + 1);"."
310 REM Move P - 1 disks from Intermediate to Destination.
320 LET S$(P) = I$(P + 1)
330 LET D$(P) = D$(P + 1)
340 LET I$(P) = S$(P + 1)
350 GOSUB 180
360 LET P = P + 1
370 RETURN
380 END

```

*run

```

Number of disks?4
Move a disk from L to C.
Move a disk from L to R.
Move a disk from C to R.
Move a disk from L to C.
Move a disk from R to L.
Move a disk from R to C.
Move a disk from L to C.
Move a disk from L to R.
Move a disk from C to R.
Move a disk from C to L.
Move a disk from R to L.
Move a disk from C to R.
Move a disk from L to C.
Move a disk from L to R.
Move a disk from C to R.

```

```

Number of disks?2
Move a disk from L to C.
Move a disk from L to R.
Move a disk from C to R.

```

```

Number of disks?1
Move a disk from L to R.

```

```

Number of disks?0

```

ready

The fact that this algorithm is correct can be proven via the principle of mathematical induction. Since a solution is defined in the case of having to move one disk and since, given a solution for n disks, a solution can be found for $n+1$ disks. That is, given a solution for one disk, we have a solution for two disks; given a solution for two disks, we have a solution for three disks, and so on. The proof that this algorithm produces the fewest possible moves is left to the reader.

Now that our algorithm is defined, we can implement the program. In many BASICs, recursion is allowed in function calls. In my BASIC, however, it is not. It turns out that recursion is supported in all BASICs for subroutine calls. The only limiting factor is the depth of subroutine nesting allowed. In my case, this limit was fifteen levels. The only major problem was the method of parameter passing. Each invocation of the HANOI program has different source, intermediate, and destination rods. In order to keep these straight, the names of these rods [L (left), R (right), C (center)] must be kept on separate stacks [S\$ (source), D\$ (destination), I\$ (intermediate)]. The variable P tells the program the number of disks to move, as well as the offset into the arrays to find the current names of the rods.

Recursion, when applied effectively, is one of the most powerful tools a programmer has. Many computer languages support recursion more fully than BASIC. Among these are Pascal, LISP, and APL. These languages allow recursive functions and local variables (local variables have separate storage locations for each invocation of the function). I hope that this Programming Quickie will prompt you to try some recursive programs. If you have access to any of the above languages, I suggest that you use them. If not, BASIC will still work. ■

The Correct Order of Operations Can Shorten Code

Pointer Decrementing on the 6502

Philip K Hooper, 5 Elm St, Northfield VT 05663

Several instances of 6502 code I have come across decrement a 16-bit pointer as follows:

DEC POINTL	decrement low byte of the pointer.
LDA POINTL	move result to accumulator.
CMP \$FF	test for page crossing.
BNE 02	if not FF, no page crossing —decrementing complete.

HOW TO MANAGE YOUR INFORMATION EXPLOSION

1. MODERN MICROPROCESSOR SYSTEM DESIGN: Sixteen Bit and Bit-Slice Architecture

Daniel R. McGlynn

Presents a detailed overview (with examples) of the new 16-bit and bit-slice microprocessors, together with modern peripheral components and devices such as:

- magnetic bubble memories
- charged coupled devices (CCD)
- CRT interface devices

Also provides a detailed 8086 instruction listing, plus programming examples using various addressing techniques. (0 471 06492-0) **April 1980** approx. 275 pp. \$20.00 (tent.)

2. PERSONAL COMPUTING: Home, Professional, and Small Business Applications

Daniel R. McGlynn

Here's a non-technical survey of the expanding field of personal computing, covering the features, capabilities, and limitations of hardware and software commercially available today. This book offers criteria for selecting and purchasing the right system for you, and explains the various programming languages from BASIC to PASCAL and APL. Many charts, photographs, detailed glossary, appendices, and much more. (0 471 05380-5) **1979** 263 pp. \$9.95 paper

3. ADVANCED ANALYSIS WITH THE SHARP 5100 SCIENTIFIC CALCULATOR

Jon M. Smith

Written for all who use a Sharp 5100 or 5101. Emphasizes numerical methods that are particularly suited to the Sharp scientific calculator. But the mathematical material is general enough so it can be used with any of the Sharp scientific machines or with small computers. Numerous examples show the new computing power available with a 5100 as a result of its unique algebraic capability. (0 471 07753-4) **1979** 132 pp. \$6.95 paper

4. WRITING INTERACTIVE COMPILERS AND INTERPRETERS

P.J. Brown

Here's a simple yet practical examination of how to implement an interactive programming language. Reviews how techniques and challenges differ from traditional non-interactive languages. Also balances material for planning/performing the task with underlying theoretical principles. No more than an ability to program and a familiarity with interactive working is assumed. (0 471 27609-X) **1979** 265 pp. \$26.95

New for the computer hobbyist...

5. INTRODUCTION TO COMPUTER MUSIC

Wayne Bateman

(0 471 05266-3) **March 1980** approx. 368 pp. \$20.00 (tent.)



WILEY-INTERSCIENCE

a division of John Wiley & Sons, Inc.

605 Third Avenue
New York, N.Y. 10016

In Canada: 22 Worcester Road, Rexdale, Ontario

Please send the books indicated for 15-DAY FREE EXAMINATION. (Restricted to the continental U.S. and Canada.)

Mail to: WILEY-INTERSCIENCE, P.O. Box 092, Somerset, N.J. 08873

Payment enclosed, plus sales tax. Wiley pays postage/handling. We normally ship within 10 days. If shipment cannot be made within 90 days, payment will be refunded.

Bill me. Bill firm or institution.

- | | |
|--|--|
| <input type="checkbox"/> 1. McGlynn (0 471 06492-0)
\$20.00 (tent.) | <input type="checkbox"/> 4. Brown (0 471 27609-X)
\$26.95 |
| <input type="checkbox"/> 2. McGlynn (0 471 05380-5)
\$9.95 paper | <input type="checkbox"/> 5. Bateman (0 471 05266-3)
\$20.00 (tent.) |
| <input type="checkbox"/> 3. Smith (0 471 07753-4)
\$6.95 paper | |

NAME _____

AFFILIATION _____

ADDRESS _____

CITY _____

STATE/ZIP _____

Prices subject to change without notice.

0-7587

DEC POINTH otherwise, decrement high byte of pointer to cross page.

The following code produces the same result, but requires two fewer bytes of code and executes 2 μ s faster:

```
LDA POINTL    bring low byte of pointer into accumulator.
BNE 02        if not zero, no page crossing, so branch ahead, skipping high byte.
DEC POINTH    otherwise, decrement high byte of pointer.
DEC POINTL    and decrement low byte of pointer.
```

Although this might seem a minor improvement, it amounts to 20% (for a pointer on page 0), and sometimes several similar small savings substantially shrink software storage space stress. ■

Sets Tutoring in BASIC

Linda M Schreiber, 29143 Carlton, Inkster MI 48141

Listing 1: Altair Extended BASIC listing for helping children learn about sets.

```
10 ' ***** SETS VER. 1 *****
20 ' ** L. M. SCHREIBER **
30 ' * 4-78 ALTAIR EXTENDED-BASIC *
40 ' PURPOSE: TO TEACH NUMBER RECOGNITION & THE NUMERICAL VALUE
50 ' OF A GIVEN SET.
60 ' MESSAGE TO AN ADULT.
70 PRINT 'THE CHILD WILL BE SHOWN A SET OF CHARACTERS.*
80 PRINT 'AFTER COUNTING THE CHARACTERS, THE CHILD SHOULD ENTER'
90 PRINT 'THAT NUMBER FROM THE KEYBOARD. IF THE CORRECT NUMBER IS'
100 PRINT 'ENTERED, THE TERMINAL WILL SMILE. IF THE NUMBER IS WRONG.*
110 PRINT 'THE TERMINAL WILL FROWN.*
120 C=INT(RND(1)*4)+35 'CHOOSE ASCII CODE FOR CHARACTER
130 N=INT(RND(1)*9)+1 'CHOOSE A NUMBER BETWEEN 1 AND 9
140 T=T+1 'COUNT NUMBER OF SETS VIEWED
145 W=0 'CLEAR COUNTER FOR WRONG ANSWERS
150 C$=CHR$(C) 'CONVERT ASCII CODE TO CHARACTER
160 PRINT:PRINT:F$="" 'CLEAR FLAG FOR NEXT ANSWER
170 FOR P=1 TO N 'LOOP TO PRINT CHARACTERS
180 PRINT C$ ' '
190 NEXT P
195 IF W=3 THEN PRINT*="N:GOTO 120
200 PRINT:PRINT:INPUT G$ 'ENTER NUMBER OF CHARACTERS
210 IF VAL(G$)<>N THEN F$="FROWN" 'CHECK ANSWER
215 PRINT:PRINT
220 PRINTTAB(23)*****
230 PRINTTAB(22)* *
240 PRINTTAB(21)* * ~ ~ * *
250 PRINTTAB(20)* * 0 0 * *
260 PRINTTAB(20)* * * *
270 IF F$="FROWN" THEN 330
280 PRINTTAB(20)* * * * * *
290 PRINTTAB(21)* * * * * *
300 PRINTTAB(22)* * * * * *
310 PRINTTAB(23)*****
320 IF T<>5 THEN 120 ELSE 380
330 PRINTTAB(20)* * * * * *
340 PRINTTAB(21)* * ( ) * *
350 PRINTTAB(22)* * * * * *
360 PRINTTAB(23)*****
365 W=W+1
370 GOTO 160
380 PRINT:PRINT:PRINT:PRINT:BYE'
390 END
OK
```

The program *Sets* (shown in listing 1) reinforces the recognition of numbers and their set values for a preschool child. Except for a message at the beginning of the program, no reading is required. All interaction be-

Listing 2: Sample run of program *Sets*. The computer outputs a smiling face when the child's answer is correct and a frowning face when the answer is incorrect.

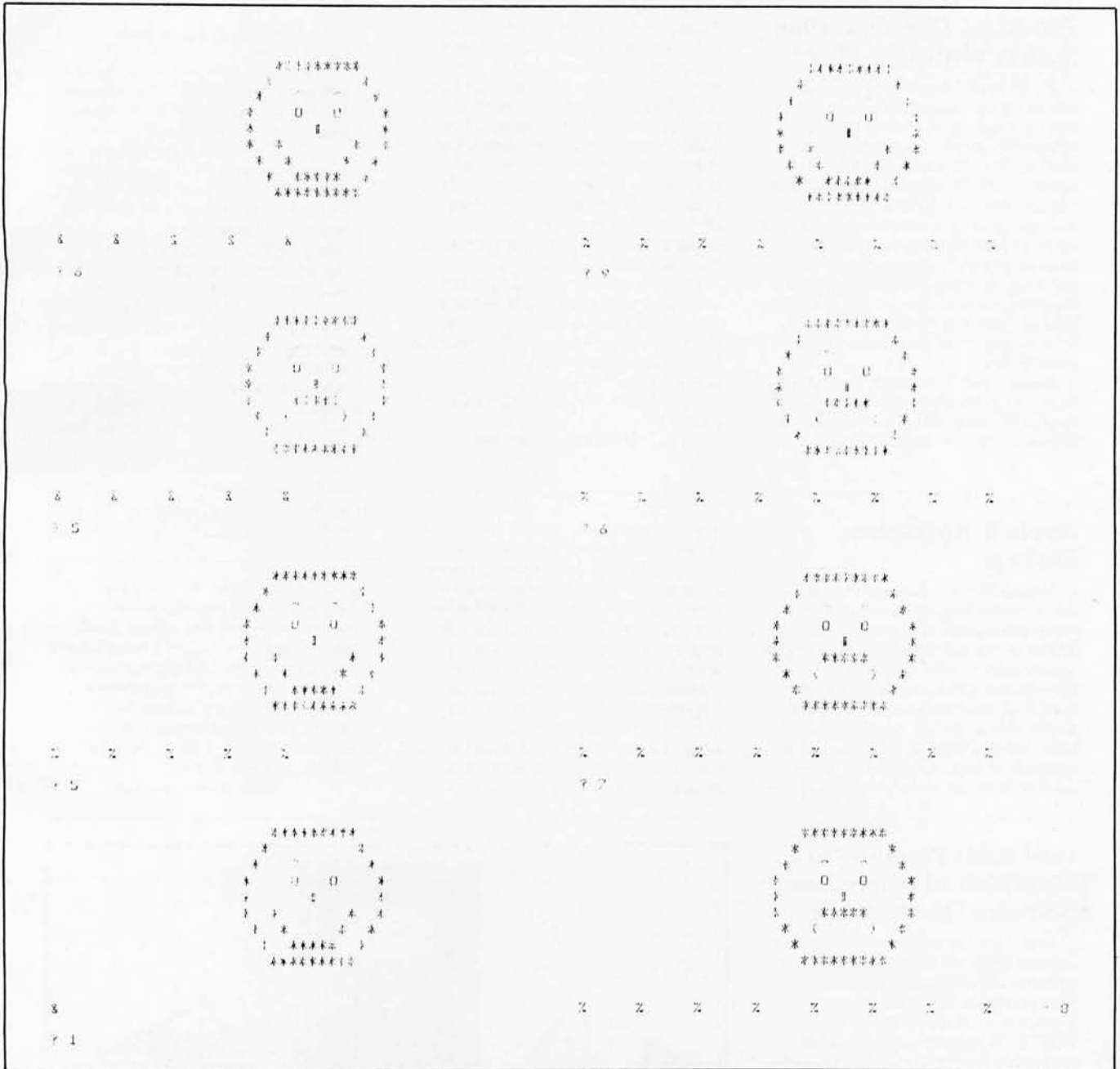

tween the computer and the child is accomplished by the use of graphics.

The terminal prints out a set of 1 to 9 characters for the child to count (see listing 2 for sample run). The child enters the number from the keyboard. If the number entered is incorrect, a frown will appear on the terminal. When the correct number is entered, the terminal will show a smile. The child is allowed three attempts to answer each set correctly. The answer will be printed after the third attempt.

In line 200, a string variable is used for input, so that a

child who mistakenly enters a letter or symbol will not become frustrated with error messages. All incorrect inputs are treated in the same manner.

The T variable in line 140 counts the number of sets the child will be shown. In this version the program will end after 5 sets. The variable can be easily increased (lines 195 and 320) for a child with a longer attention span. Similarly, the 9 in line 130 can be changed to a greater value for the child who has mastered sets from 1 to 9.

Sets is written in Altair (Microsoft) Extended BASIC and uses just over 1 K bytes of memory. ■

What's New?

SOFTWARE

Z80-Based Disk Operating System Written in PL/M

A Z80-based operating system which allows up to four simultaneous users and hard disk-drive control has been released by Altos Computer Systems. AMEX (Altos Mutli-User Executive) is written in PL/M and is compatible with CP/M versions 1.4 and 2.0. AMEX can manage up to four user-memory areas of up to 48 K bytes each. It utilizes a priority ordered interrupt-driven dispatching algorithm. Priority is given to input/output (I/O) bound tasks, while microprocessor compute-bound tasks tend to migrate to the bottom of the priority line.

Access to on-line storage on floppy or hard disk is handled for multiple users by AMEX, using direct memory address (DMA) hardware. AMEX features a

dispatcher and a spooler that allocate and free various peripheral devices as requested by user programs or commands. The system is designed to carry on multitasking operations within an individual user's 48 K memory block. AMEX includes a screen-oriented text editor, an 8080 assembler, built-in utilities, file management commands and a transient command handler which allows the user to define new disk-oriented commands separate from those implemented by CP/M.

AMEX requires an Altos ACS8000 series computer and 64 K bytes for one user, 112 K bytes for two users, and 208 K bytes for four users. It is priced at \$250 and comes on a single floppy disk. Contact Altos Computer Systems, 2338-A Walsh Ave, Santa Clara CA 95050.

Circle 400 on inquiry card.

Where Do New Products Items Come From?

The information printed in the new products pages of BYTE is obtained from "new product" or "press release" copy sent by the promoters of new products. If in our judgement the information might be of interest to the personal computing experimenters and homebrewers who read BYTE, we print it in some form. We openly solicit releases and photos from manufacturers and suppliers to this marketplace. The information is printed more or less as a first in first out queue, subject to occasional priority modifications. While we would not knowingly print untrue or inaccurate data, or data from unreliable companies, our capacity to evaluate the products and companies appearing in the "What's New?" feature is necessarily limited. We therefore cannot be responsible for product quality or company performance.

Apple II Animation Package

The A2-3D1 is a package of easy to use assembly language programs for three-dimensional and two-dimensional animation on the Apple II. The program allows users to view two- or three-dimensional scenes created in the standard XYZ coordinate system, zoom between wide angle and telephoto fields of view, select a location in space, and a direction of view. One feature allows users to generate an output array of line

start and end points instead of plotting on the Apple screen. Other features include zero page restore which leaves all zero page variables intact after subroutine exit, page control for selective page erase, display, and draw for ping-ponging between screens for smooth animation. The load and go manual guides beginners through an orientation session with the A2-3D1 program. The technical manual is for advanced applications and describes the transformer algorithm in detail. The program requires 16 K bytes of pro-

grammable memory for the three-dimensional and two-dimensional transformer, small scenes, and small control programs. Larger scenes, control programs and the DEVELOP program require 24 K bytes of programmable memory. The program costs \$45 on cassette and \$55 on floppy disk. For more information, contact Sublogic, POB 5, Savoy IL 61874.

Circle 401 on inquiry card.

Intel Adds Pascal-80 to 8080/8085 Microprocessor Software Development

Intel Corp has developed Pascal-80 to support 8080 and 8085 microprocessor software development on Intellec microcomputer development systems. Similar to its PL/M, BASIC, and FORTRAN programs, the Pascal-80 package is available on floppy disk and runs under the ISIS-II operating systems on Intellec Series II and MDS-800 models. This Pascal-80 offers extensions that make the language suitable for commercial and industrial applications. The extensions include three new data types—the string type, untyped files, and interactive files—plus twenty-eight predeclared procedures and functions. Pascal-80 provides a Trace facility allowing a user to monitor program execution, and a set of compile and runtime error diagnostics. Users create Pascal source programs using the Pascal-80 software and standard Intel microcomputers. The Pascal-80 software

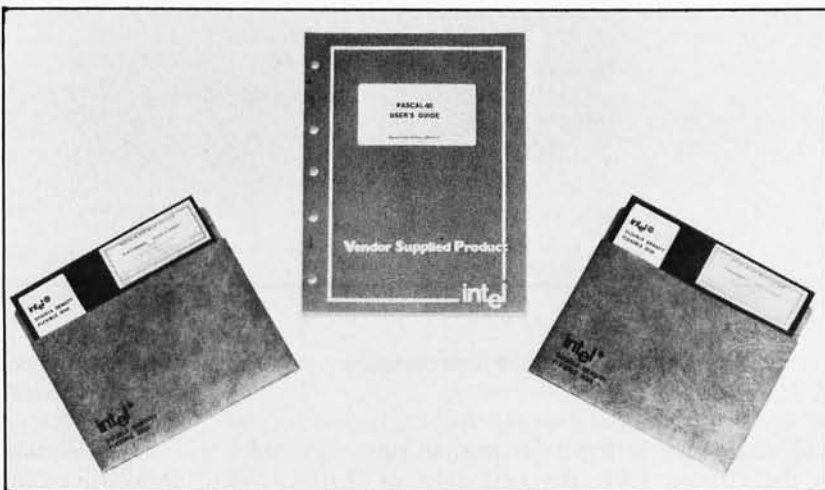

package includes a floppy disk containing a compiler, a pseudocode interpreter and demonstration programs, a Pascal-80 user's manual and the *Pascal User Manual and Report*, second edi-

tion, by Jensen and Wirth. The software package is priced at \$975 and is available from Intel Corp, 3065 Bowers Ave, Santa Clara CA 95051.

Circle 402 on inquiry card.

What's New?

SOFTWARE

Bell and Howell Introduces Software for Education

These software packages from Bell and Howell allow instructors to create courseware for students. No prior programming knowledge is needed by either instructor or students. Some of the features of the Generalized Instructional Systems (GENIS) include the authoring system which allows teachers to create curriculum material, obtain grade reports, control class enrollment, and more. A system that allows student interaction with the computer is included. The programs understand misspelled words; present lessons in words, animation, graphics, and color; grade student performance; generate drills, practice, and simulation programs; and other administrative projects. The GENIS program is priced at \$300. Write to Bell and Howell Audio-Visual Products Division, 7100 N McCormick Rd, Chicago IL 60645.

Circle 403 on inquiry card.

Information Storage and Retrieval (ISAR) for TRS-DOS

ISAR is a data base management system designed for users of TRS-DOS random file structures. The system utilizes the limited TRS-80 chaining techniques that keep as much of the program in memory as necessary to perform any given function.

The basic ISAR system consists of six modules which allow users to create new files, define all elements within each file, and manipulate each file. Each file or portion of a file can be sorted using BASIC Shell-Metzer sort. The package includes source listing, documentation, potential recovery techniques in the event of a system failure and suggested personal applications. ISAR comes on cassette for \$13.95 or diskette for \$16.95. For further information, contact The Alternate Source, 1806 Ada St, Lansing MI 48910.

Circle 405 on inquiry card.

Multitasking Disk Operating System for 8080, 8085, and Z80 Systems

EFAMOS is a disk-operating system for 8080, 8085, and Z80 systems that supports multitasking and multiusers with memory mapping. Up to 3 M bytes of memory can be available to users through 32 K byte memory banks. EFAMOS is compatible with all software

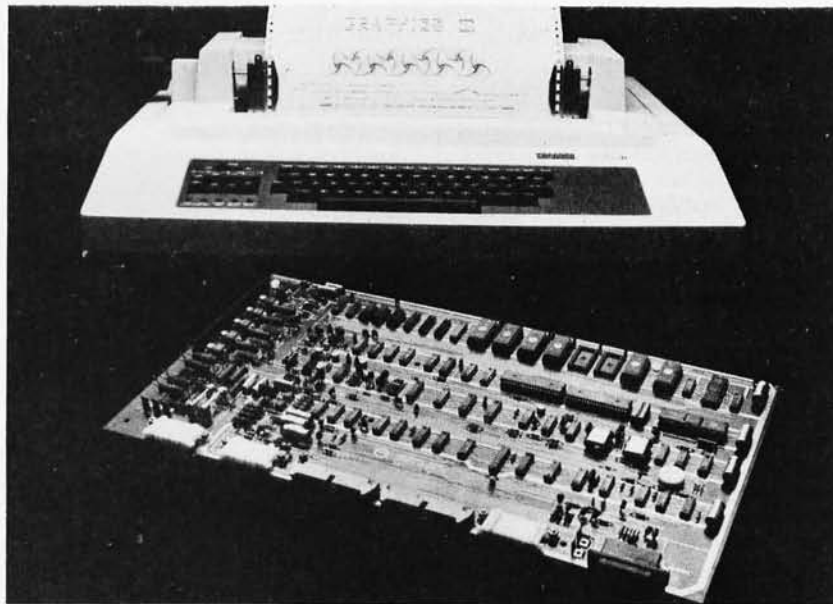

DECwriter Graphics Available for Timeshare Computers

Graphics II is a modification to the DECwriter II printer for conversion to a plotter. Graphics II features APL character set, forms control, horizontal and vertical tabs, answerback, bi-directional line feed, four character sets

with four different styles—characters can be printed in four directions. The average speed is 40 characters per second (cps). One inch per second for plotting and communication up to 12 bits per second (bps) is possible. The price is \$850, and Graphics II is available from Selanar Corp, 2403 DeLaCruz Blvd, Santa Clara CA 95050.

Circle 404 on inquiry card.

Space Shuttle Landing Simulator

This program is modeled after the NASA Shuttle Mission Simulator in Houston. It is a real flight simulator (except for roll motion) with a visual display of the sky and ground. High resolution graphics show the cockpit view using animation, projective geometry, and graphics to depict the runway, sky, ground, and distant mountains and clouds. The paddles control the pitch control and speed brakes. Speed, altitude, sink and climb rate, distance from the threshold, speed brake

setting, glide slope, and angle of attack are displayed. Warnings and messages are also displayed.

Functional features include angle of attack control, full stall capability, eject and eject warning, landing gear, speed brakes, and wheel brakes on rollout. Runway stripes on roll out give a visual indication of motion.

The program is available from Harvey's Space Ship Repair, POB 3478, University Park, Las Cruces NM 88003, for \$15 on cassette. A floppy disk version is also available.

Circle 406 on inquiry card.

developed under MVT-BASIC. It provides full system support to each memory bank, including assembler BASIC run-time, system utilities, BASIC, utilities and word processing. BASIC support includes chaining with parameter passing and machine language calls with over ten ISAM functions. Word processing activities with several concurrent users can be completely supported in one memory bank, while program development and data processing functions are supported in other

memory banks. Batch monitors can reside in any bank of memory and can process job files submitted from any other bank. One design feature of EFAMOS precludes terminal lockup during any input/output operation, which prevents the loss of characters in a busy multiuser environment. For licensing and terms, contact MVT Microcomputer Systems Inc, 9241 Reseda Blvd, Suite 203, Northridge CA 91324.

Circle 407 on inquiry card.

What's New?

SOFTWARE

Pascal for the 8080 and Z80 Processors

Built upon Whitesmiths' C compiler and libraries, the Pascal Development System provides a software environment for Pascal programming on PDP-11, LSI-11, 8080 and Z80 computers. The compilers and all support utilities run under IDRIS, UNIX, RT-11, RSX-11M, RSTS, or IAS on the PDP-11 and LSI-11, and under CP/M or CDOS on the 8080 and Z80, producing code that runs faster than Pascal interpreters. Included as part of the package are an A-Natural assembler, an 8080 linking loader, a librarian, and other utilities. Users also receive the Whitesmiths' Portable Pascal and C library and manual. Supporting these portable libraries are an operating system-specific interface library, a machine library, and 64-bit floating point arithmetic. The 8080/Z80 and PDP-11 Pascal Development Systems, are available from Lifeboat Associates, 2248 Broadway, NY NY 10024, for \$750 per single micro-processor license.

Circle 408 on inquiry card.

Graham-Dorian Introduces a Software Medical Package

This package was written and tested by medical professionals. It handles billing insurance forms, treatment records, charge and payment entry, patient statements, Medicare submittals, collection accounting and dunning, patient processing, patient listing, aged accounts receivables, transaction reporting, and more.

The package can be ordered on eight-inch floppy disks and includes a manual and hard copy source listing. The price for the program is \$1000 and is available from Graham-Dorian Software Systems Inc, 211 N Broadway, Wichita KS 67202.

Circle 409 on inquiry card.

Language Translator Program

This program translates from English to any foreign language, from any language back to English, or from one foreign language to another. Simple commands bring in the correct vocabulary or words. The program checks the entire sentence for the proper verb conjugation and word contractions. New words may be added at any time and saved as part of the vocabulary. One mode lets the translator receive

Machine Language Disk File Sorting Program for Apple II

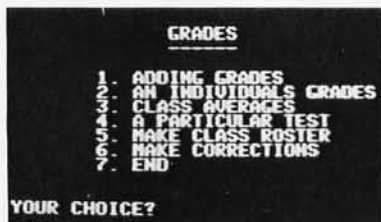

Datacope, POB 55053, Hillcrest Sta, Little Rock AR 72205, has released an enhanced version of their sorting program that is compatible with either the Apple II or the Apple II Plus computer systems. The new version of the

Datacope Single Disk Sort performs user-specified direct commands upon completion of the sorts, for easy use in turn-key systems. The program employs one disk drive, and sorts a single file of fixed-length records on a single floppy disk. A file may fill the entire disk because the program uses no workspace on the disk. Blocks of consecutive records may be sorted without disturbing the remainder of the file. Files may contain records with 5000 characters and may be sorted by ten key fields simultaneously, with each key field in either ascending or descending alphabetical or numerical order. The program features other necessary functions. The package includes a manual and a floppy disk with the sort programs, a test file, and test file access programs in Applesoft II for \$49.95.

Circle 410 on inquiry card.

CP/M Compatible Operating System for TRS-80 Level II Computers

A fully CP/M compatible operating system for the TRS-80 II computer has been developed. The operating system works with CBASIC and all other CP/M programs, requiring no changes to the operating codes. The system sells for \$249.95 from MPU, POB 808, San Carlos CA 94070.

Circle 411 on inquiry card.

More Programs for Apple II Systems

Apple Barrel Bushel #1 is a collection of twenty-five programs including Mortgage Loan, Days Between Dates, Calendar, Savings, Checkbook, Addition, Subtraction, Metric Conversion, Luna C, Apple LeMans, Alien, and more. The package is available on cassette tape for \$24.95 or on floppy disk for \$29.95. Contact CDS Corp, 550 N Main St, Logan UT 84321.

Circle 412 on inquiry card.

A Forth Software Development Tool

The XL5 is an interactive programming system with compiler, interpreter, assembler, disk operating system, and a library of procedures. It is written in XL5 and is based on the recommendations of the 1977 Forth Standards Committee. A host-executable code kernel, a source code kernel, and a system generation program (SYSGEN) are provided. SYSGEN regenerates the kernel from the source or generates read-only memory (ROM) modules. An XL5 development system requires less than 32 K bytes of memory. The \$100 package includes source code and a reference manual. XL5 is available with a CP/M boot loader for the 8080 and the Z80. For information, contact XL Computer Products, 321 E Kirkwood Ave, Bloomington IN 47401.

Circle 414 on inquiry card.

1979 Federal Tax Programs for Microcomputers

Aardvark Software Inc, POB 26505, Milwaukee WI 53213, is marketing a software program which will calculate an individual's federal tax liability. The program displays the tax information as it would appear on an IRS form. It also calculates the tax liability using the tax tables, tax rate schedules, income averaging, maximum tax on earned income, and alternative minimum tax choosing the most favorable method. A manual is included to organize the tax information for input. Three programs are available at \$22, \$35, and \$50.

Circle 415 on inquiry card.

data in one language from a reader, and then sends the translation to a printer. Display formatting commands show vocabulary words alphabetically or in categories. Spelling errors are caught and corrected.

The Language Translator from Practical Programming Corp, POB 3069, N Brunswick NJ 08902, is available on CP/M or North Star floppy disk with one extended language for \$30. Additional languages are \$10 each.

Circle 413 on inquiry card.

What's New?

PUBLICATIONS

Guidebook for the TRS-80 Level II Microcomputer

Learning Level II, written by Dr David A Lien, is a step-by-step guide to help users of the Level II TRS-80. It contains a section updating the Level I manual to Level II. Readers are guided through the fundamentals and special characteristics of Level II BASIC, beginning with setting up the system. The book explains how to properly use the Editor to change and correct BASIC programs. Another section is devoted to the conversion of Level I programs to Level II. The book also explains dual cassette operation, using the expansion interface box with the real-time clock, printers and other peripheral devices. It is available from Computer Books Division, Compusoft Inc, 8643 Navajo Rd, San Diego CA 92119, for \$15.95, plus \$1.45 for postage and handling.

Circle 416 on inquiry card.

1980 Computer Catalog

Sara Tech Electronics Inc, POB 692, Venice FL 33595, is offering their sixteen-page 1980 computer catalog featuring more than 1000 products. All major brands of computers and equipment are carried. Write for a free copy.

Circle 417 on inquiry card.

Catalog Features Articles on Classroom Computing

Creative Publications is publishing a color newsletter/catalog of computer materials for the classroom. The publication features an article on the television documentary "Don't Bother Me, I'm Learning," which discusses computers in education. All products in the catalog are described with the educational user in mind. The catalog is available from Creative Publications, POB 10328, Palo Alto CA 94303.

Circle 418 on inquiry card.

Documentation Standards for Computer Systems

Norman L Enger's *Documentation Standards for Computer Systems*, Second Edition, is a reference manual that shows how to document a computer application to utilize the full potential of the computer resources. The book includes revised and expanded material that describes the evolution of a system through the stages of initiation, analysis, design, development, implementation, and operation. The sec-

TRS-80 Software Source

This catalog contains over 5000 software listings that are available from 380 suppliers. The publication lists business, education, games, home, math, and utility software with a section of addresses of the suppliers. A one-year subscription is \$15 and a single issue is \$6. Contact Computermart, POB 1664, Lake Havasu AZ 86403.

Circle 419 on inquiry card.

Computer Book Catalog Released by Sams

The Howard W Sams and Co Inc has released a catalog featuring a large selection of computer and computer related titles. It is organized for quick reference into five areas—basics, programming, computer technology, reference, and computer related. This free catalog details books that are directed to a wide range of people and interests, from the home hobbyist to the technically oriented professional.

For a catalog, contact the Advertising Director, Howard W Sams and Co Inc, 4300 W 62 St, POB 558, Indianapolis IN 46206.

Circle 420 on inquiry card.

New Renaissance!

New Renaissance! is a bimonthly magazine for lighting and laser artists and technicians who desire to share their works, events, goals, and discoveries with others in the field. It features performance news and reviews; projects, plans and schematics; new techniques and products; interviews; books and other data sources, and more. A one-year subscription is \$25 and is available from *New Renaissance!*, 5267 11th Ave NE, Seattle WA 98105.

Circle 421 on inquiry card.

tion on "Techniques and Tools for Analysis" facilitates the analyst's work. This book aids in determining the amount of documentation needed for specific types of projects. Procedures can be established to employ documentation standards adopted by the organization. Dr Enger's book is useful to computer professionals, students and novices in the computer industry. It is available by mail for \$25 from The Technology Press Inc, POB 125N, Fairfax Station VA 22039.

Circle 422 on inquiry card.

Magazine on Robotics

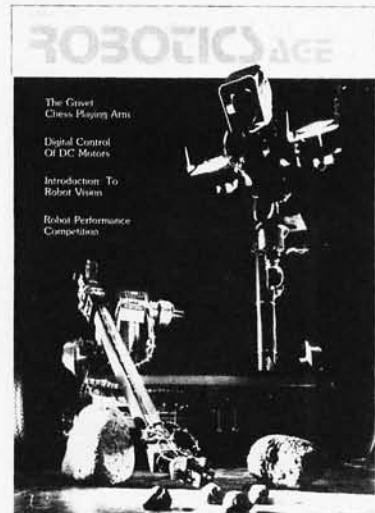

Robotics Age magazine contains readable articles of high technical content that present the latest results of research in robotics and artificial intelligence. The contents include well-documented electromechanical circuit designs, microcomputer interfaces, and programming techniques suitable for economical applications to small systems. Abstracts of research papers are also featured. New products items describe new commercially available kits and robotics related products. The quarterly publication is available at \$8.50 for one year from *Robotics Age*, POB 801, La Canada CA 91011.

Circle 423 on inquiry card.

Publication of Sorting Subroutines

Creative Computer Consultants Inc, POB 2111, 1 Quarry Ln, Norwalk CT 06851, has published volume 4 of *Sortmaster* in the Standard Software Library. *Sortmaster* contains listings of five BASIC subroutines designed to sort numeric data in memory. The subroutines have been designed to be integrated into the user's main line program. Numeric fields are sorted by designating that field as the sorting key. This makes it possible to sort records of any length and also permits multiple sorting keys. By adjustment of certain variables, all of the routines can handle alphanumeric data as well. *Sortmaster* includes an introduction to basic sorting concepts as an aid to beginners. The programs work with the TRS-80, PET, and Apple II. The book costs \$8.95.

Circle 424 on inquiry card.

What's New?

PERIPHERALS

Eight-Inch Winchester Disk Up to 20 M Bytes



The Series 7000 hard disk drives have unformatted capacities of 4 megabytes in the single disk version, 12 megabytes in the double-density version and 20

megabytes in the three-disk unit. Data transfer rates are 5.5 million bits per second (bps). The Series 7000 employs the Winchester technique, using an ironless rotary actuator to position the heads in response to prerecorded servo-tracks on the lower side of the bottom disk.

Each 21cm diameter surface has a 350-track cylinder with an inner track recording density of 5280 bits per inch. The interface is designed for use with microprocessor-based controllers. The drives utilize eight-bit bidirectional bus transfers. Line transceivers enable daisy-chain connection of other disks to the bus.

The 4 megabyte drive, the 7000-4, is \$2100; the 7000-12 is \$2300; and the 7000-20 is \$2650. The units are manufactured by Kennedy Co, 1600 S Shamrock Ave, Monrovia CA 91001.

Circle 425 on inquiry card.

Stockey Series of Keyboards

The Stockey Series offers ten general-purpose standard keyboard designs, including six with American Standard Code for Information Interchange (ASCII) encoded alphanumeric formats. These are available in ASR33, ANSI teletypewriter, IBM 3278 ASCII typewriter, IBM 3278 data entry, and IBM Selectric I and II typewriter formats. An eleven- and fifteen-Key

Expander pad can be added via a flex-strip jumper to any of the six alphanumeric designs to provide high-speed numeric entry.

The 53-key SK053 for the Model 33 teletypewriter features uppercase, but no lowercase, and costs \$139. The 67-key model includes uppercase and lowercase, a full ASCII set, and is priced at \$173. For additional information, contact Advanced Input Devices, POB 1818, Coeur d'Alene ID 83814.

Circle 426 on inquiry card.

12 VDC Alphanumeric Printer System



The PR6024 printer controller and any SODECO PR Series print mechanism comprise a print system operable from a 12 V power source. The controller accepts a 7-bit parallel ASCII format and features an integral voltage regulator and adjustable input thresholds for immunity from environmental noise. The unit features a 54-character alphanumeric set. Applications include mobile electronics, such as truck-mounted fuel-dispensing systems, police cars, security systems, and battery sustained instrumentation and systems. The price for the 15-column tape printer and PR6024 controller is \$363 in unit quantity. For more information, contact the Sales Manager, Print Products, SODECO, Landis and Gyr Inc, 4 Westchester Plz, Elmsford NY 10523.

Circle 427 on inquiry card.

Eight-Color Digital Plotter with Microprocessor Control

Soltec's Model 281 Digital Plotter provides graphic representation of measured values, design data and calculated data using up to eight different color pens. A Z80 microprocessor controls the system, the automatic pen changing, off-scale data handling, and coordinate transformation. The programmable pen changing feature incorporates up to eight pens using multicolor fiber-tip pens or Rapidograph drafting pens. Firmware features include circle interpolation, character plotting, generation of axes and grids, various line types, window plotting and more. Model 281 also features character plotting in five fonts, automatic or interactive point digitizing, programmable offsets and programmable limits. The graph paper is standard DIN-A3 format or smaller. Inter-

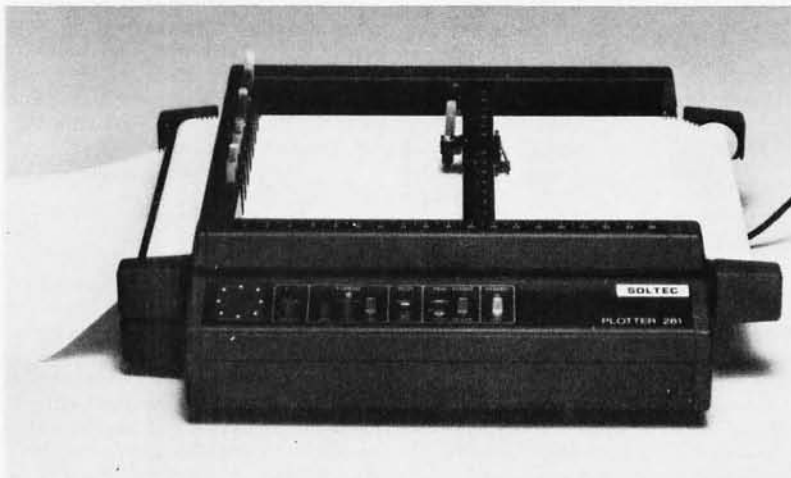

faces include a choice of serial RS-232C/V.24 and 20 mA current loop. The plotter costs \$4725 and is available

from Soltec Corp, 11684 Pendelton St, Sun Valley CA 91352.

Circle 428 on inquiry card.

What's New?

PERIPHERALS

Miniature Alphanumeric Thermal Printer

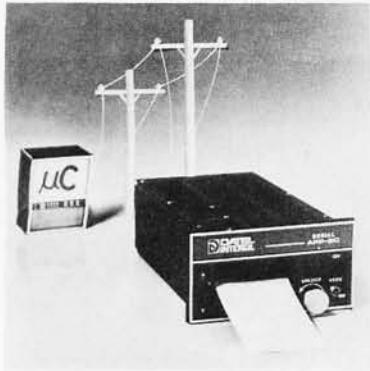

The APP-20A2 twenty-column, panel-mount thermal printer uses only two input data wires for interfacing. It features serial 20 mA current loop and RS-232C ports. The printer can be used in data systems, factory data acquisition units, and industrial data loggers with a full alphanumeric printer. It can be used with a remote control unit or in medical systems, and as a portable test and measurement tool for laboratory or field use. The unit prints 1.2 lines per second. It measures 20 cm by 7 by 11.3 cm (8 by 2.76 by 4.44 inches) and weighs 1.9 kg (4.25 pounds). It is available from Datel Intersil, 11 Cabot Blvd, Mansfield MA 02048. The cost for the printer is \$880.

Circle 429 on inquiry card.

Robotype Converts Typewriter to Printer

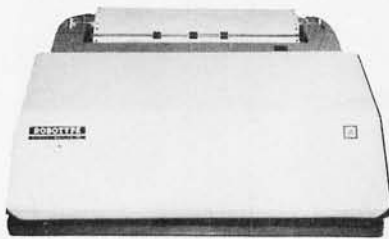

The Robotype Model 2100 is capable of interfacing with a Centronics-compatible parallel interface, RS-232C

serial interface, and a 20 mA current loop. The RS-232C serial interface has 110, 134.5 or 150 switch-selectable data rates. The Robotype can be attached to the IBM Selectric, Remington Rand, Olympia and Facit typewriters. The Robotype is placed over the keys of the typewriter. Plungers rest on the keys and push the keys down on command from the computer input. The unit types the maximum speed of the typewriter in use. The unit is available for under \$1000 from Applied Computer Systems Inc, 77 E Wilson Bridge Rd, Worthington OH 43085.

Circle 430 on inquiry card.

Alphanumeric Thermal Printers

Priced at approximately \$440, the United Systems 6450 and 6460 alphanumeric thermal printers produce easy-to-read letters, numbers, and symbols on thermal paper with first-line-up printout. They print a set of 64 different characters with 21 characters per line and approximately 6500 lines per roll of paper. The Model 6450 provides a serial input with selectable RS-232C or 20 mA current loop format with data rates of 110 and 300 bits per second (bps). The Model 6460 is 8-bit parallel bus-compatible with data rates up to 1000

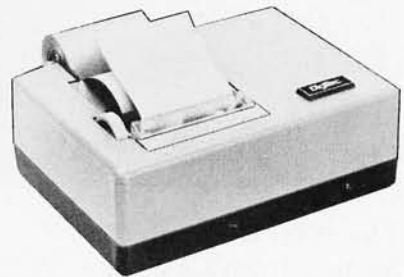

characters per second (cps). Both models respond to ASCII input. For more information, contact United Systems Corp, 918 Woodley Rd, Dayton OH 45403.

Circle 431 on inquiry card.

Corvus Disk System for Apple Pascal Microcomputer

The Corvus model 11AP disk system being delivered for Apple Pascal is entirely compatible with the Apple system. No modifications are needed for the Apple Pascal disk-operating system, or any applications designed to run on the Apple floppy disks. Corvus has incorporated a utility called "dynamic volume management" that allows the ten million byte data base to be used as a single large block or to be broken into smaller blocks. Applications of the Apple Pascal equipped with the Corvus 11AP system include: customer and prospect mailing lists, accounting data, payroll and personnel records, courses in computer programming and usage, science applications, medical office use, and more. The system is priced at \$5350. The controller can handle up to three additional disks, which are priced at \$3690. Contact Corvus Systems, 900 S Winchester Blvd, Suite 4, San Jose CA 95128.

Circle 432 on inquiry card.



What's New?

SYSTEMS

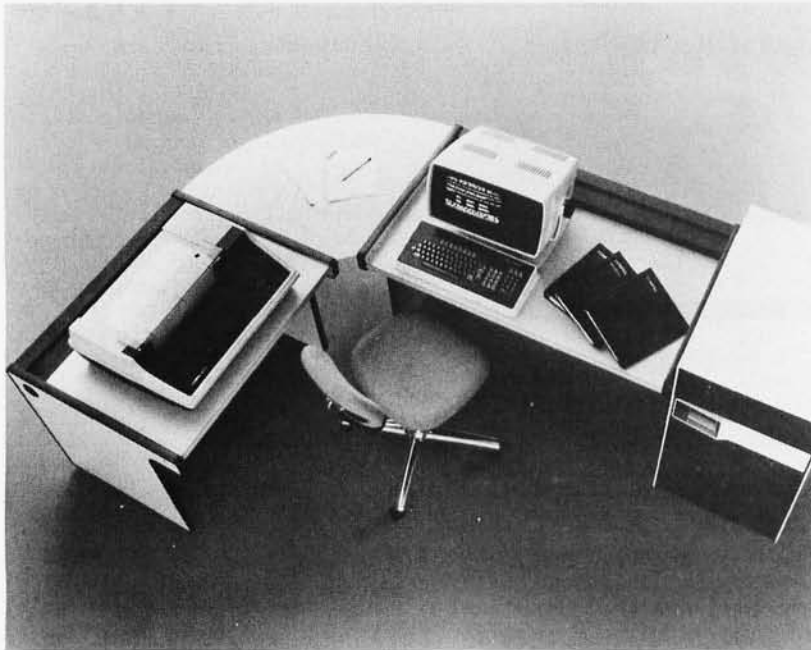

The 9000 Computer System from Compal

The Compal Model 9000 is designed for business and office environments. The system includes a 16-bit microNova 602 processor, 64 K bytes of program-mable memory, video display terminal with a detached keyboard that can support up to three additional keyboards, a 10 M byte hard disk with a 5 M byte removable cartridge, and a high-speed

matrix printer. Included with the system are BASIC and assembly languages, manuals, training, starter supplies, and delivery. Programs for inventory control, sales analysis, accounts payable and receivable, general ledger, payroll, and other business applications are available. The system sells for \$19,995 from Compal Inc, 6300 Variel Ave, Woodland Hills CA 91604.

Circle 433 on inquiry card.

TM990 Compatible Bubble Memory Module

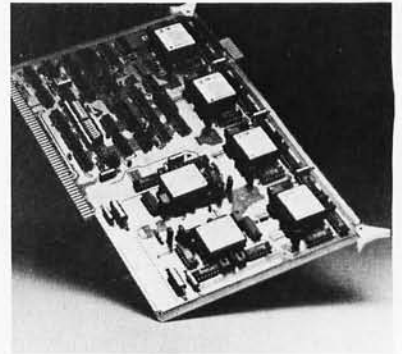

A TM990-compatible board with up to 69 K bytes of non-volatile magnetic bubble memory storage has been announced by Texas Instruments Inc, POB 225012, M/S 308 (ATTN: TM990/210), Dallas TX 75265.

The TM990/210 board is supplied with two, four, or six 92 K bit TIB 0203 bubble memories for 23 K, 46 K, or 69 K bytes of storage, respectively. Data transfers from the module are via a memory-mapped mode. Access time is 4 ms, and data transfer rate is 45,000 bits per second (bps). The price for the TM990/210-1 two-bubble device is \$775; \$1150 for the TM990/210-2 four-bubble device; and \$1535 for the TM990/210-3 six-bubble device.

Circle 434 on inquiry card.

Development Tool for 6500 Series Microprocessors

The MDT 1000 enables users to write programs and debug hardware and software. The MDT 1000 includes a 54-key keyboard and case; 12-inch video display; dual cassette interface; power supply; erasable-programmable read-only memory programmer; 4 K byte static programmable memory-board; sockets for extra boards; and a four-slot motherboard. Software support comes as 12 K bytes of read-only memory resident firmware; a 4 K byte monitor with debug features; and an 8 K byte assembler and editor, which operates on line-numbered text. A floating point BASIC and software for printer interfacing and other controls are available. The MDT 1000 is available for \$1495 from Synertek, 3001 Stender Way, Santa Clara CA 95051.

Circle 435 on inquiry card.

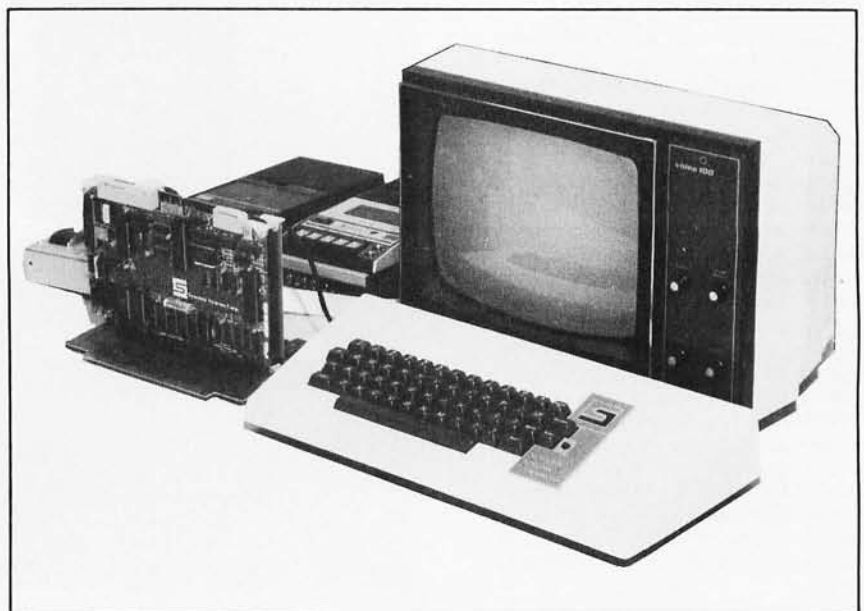

What's New?

MISCELLANEOUS

TRS-80 Printer Controller

The Printer Timer works with the TRS-80 and the Centronics 779 line printer by automatically turning the printer on and off using signals relayed over the printer cable. The device does not require software or hardware modification other than the soldering of three wires and the mounting of the timer inside the printer cabinet. The timer reduces motor wear and excess noise. It is available for \$95 from National Software Marketing Inc, 4701 McKinley St, Hollywood FL 33021.

Circle 436 on inquiry card.

Voice Terminal for the Exidy Sorcerer Talks and Listens

Cognivox plugs into the Sorcerer and offers a sixteen-word recognition vocabulary plus voice response with up to sixteen words or phrases. Recognition accuracies of up to 98% are possible. The unit includes a microphone and amplifier and speaker, making it a complete voice terminal. A software library is provided with Cognivox. It includes Voicetrap, a voice-operated video game, and Vothello, a voice input version of the game Othello. A talking calculator program allows using the Sorcerer as a four-function calculator, and a vocal memory dump program can read its memory out loud. Cognivox is priced at \$149 from Voicetek, POB 388, Goleta CA 93017.

Circle 437 on inquiry card.

Anti-Glare Device for Video Screens

The product is a black woven nylon mesh stretched on a flexible plastic frame. It is designed to be sandwiched behind the video bezel and to conform against the surface of the tube. This device performs by blocking and absorbing ambient light with a honeycombing effect. The contrast is enhanced by the black matrix effect of the fabric background, while the display characters are transmitted undistorted through the pores in the material. The filters are available in 120 sizes, and each size can be equipped with different optically-graded fabrics to vary the intensity of the video display. The filters improve the image, lower maintenance, and reduce eye strain and related stress. For more information, contact Sun-Flex Co Inc, 3020 Kerner Blvd, San Rafael CA 94901.

Circle 438 on inquiry card.

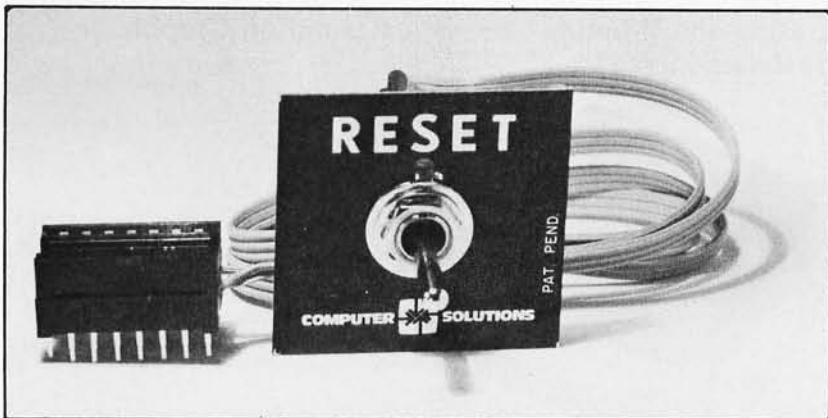

Reset Option for the Apple

Model B is a three-position switch giving the user the option of completely disabling or enabling the reset key on the keyboard. It is easily installed between the keyboard plug and the Apple's board. When the switch is in the down position, the keyboard is functional. With the switch in the middle

position, the reset key on the keyboard is disabled, and the user must flip the switch up to reset the computer. The switch automatically returns to the middle position when released from the up position.

It is available from Computer Solutions, 5135 Fredericksburg Rd, San Antonio TX, 78229, for \$29.95.

Circle 439 on inquiry card.

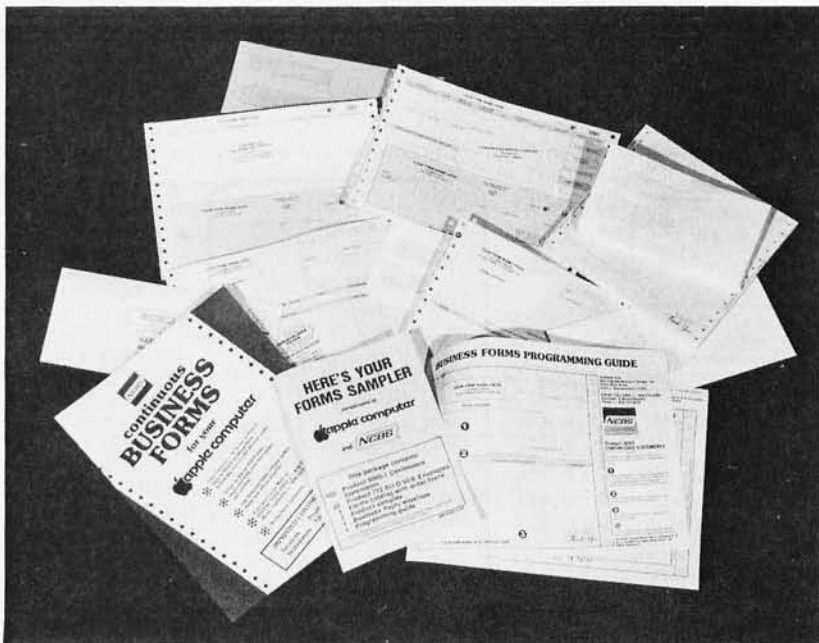

Standardized Computer Forms

New England Business Service (NEBS) is offering a line of continuous-form computer checks, statements, and invoices. The forms are available with the name of the firm, address and phone number in six quantities from 500 to 6000 forms. Prices start at \$14.95 for 500 statements; \$32.50 for 500 two-part

invoices and \$29.95 for 500 of either the payroll or all-purpose checks. At 6000-piece order levels, prices per thousand drop to \$12.50, \$33 and \$22.50 respectively. The firm also offers custom personal checks for home computer systems users. For ordering information and free samples write to the New England Business Service Inc, N Main St, Groton MA 01450.

Circle 440 on inquiry card.

What's New?

MISCELLANEOUS

Simple Machines for Erasing and Winding Cassettes



Two battery-powered machines offer longer life for cassettes and reduced wear on standard cassette players. The Erase-Sure passes the cassette through a rotating magnetic field that erases the tape and leaves an extremely low residual noise level. The user slides the cassette through the unit once. This

Prototyping Kit for High-Resolution Graphics

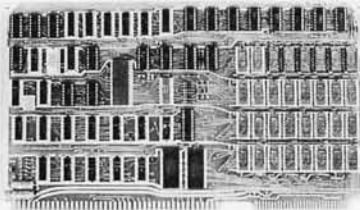

The SVB-80P prototyping kit is a dual-board system with stand-alone capability in an Intel multibus configura-

single pass completely erases the tape. The Rapid Rewind stabilizes cassette tape tension, eliminates tape binding, helps control wow and flutter, and winds a 60-minute tape in approximately 30 seconds. Both units permit the use of a 115 V AC adapter to reduce battery costs. The machines are available from Magnesonics Sales and Manufacturing Co, POB 758, Ventura CA 93001. They cost \$24.50 each.

Circle 445 on inquiry card.

tion. The graphics package features displays of 640 by 409 or 576 by 455 pixels, alphanumeric characters displayed over 80 by 40 or 72 by 44 lines, and intermixable characters with graphics. It interfaces with other multibus-compatible products. The SVB-90 Soft Video Board and the MIB-85 Memory Intensive Board can also be used individually in computer graphics, text editing, scientific applications, and industrial environments. The price for the SVB-80P is approximately \$1600. Contact DOSC Inc, 175 I U Willets Rd, Albertson NY 11507.

Circle 446 on inquiry card.

Computer Cables for the TRS-80

Matchless Systems, 18444 Broadway, Gardena CA 90248, manufactures cables for floppy disk and tape drives, printers and other peripherals for the TRS-80 computer. The price for the two-drive cable is \$24.50 and the four-drive cable is \$34.50. The cable for the MS-204 printer or any other Centronics-compatible printer, sells for \$34.50.

Circle 447 on inquiry card.



MICRO BUSINESS WORLD MAIL ORDER

Immediate response to your orders (verbal or written). Phone (213) 371-1660



Apple II personal computer.

16K Regular or Plus \$ CALL

Disk II with controller \$ CALL
Disk II without controller \$ CALL
PASCAL Language Card \$ CALL
CALL for our lowest prices ever. We carry all peripherals and interface boards for the APPLE. European versions available.

DYSAN DISKETTES

THE CADILLAC OF THE FLOPPY DISKS AT LOW LOW PRICES

8" (BOX OF 10)

3740/1 sgl side/ sgl density 4.00 ea

3740/1D sgl side/ dbl density 6.50 ea

5" (BOX OF 5)

104/1 soft sector 4.00 ea

107/1 10 sectors 4.00 ea

105/1 16 sectors 4.00 ea

For each 2 boxes of 8" or 4 boxes of 5" you get one plastic storage case, but hurry — supply is limited

ATARI 800 Personal Computer System

Packed with: Computer Console, Basic Language Card, Education System Master Cartridge, Cassette Recorder, TV Modulator, 8K Memory (expandable to 48K), Power Supply & all Books and Manuals \$ CALL

ATARI 400 Personal Computer System for less

Packed with: Computer Console, Basic Language Cartridge, Power Supply, TV Modulator, and all Books and Manuals \$ CALL

ATARI Program Recorder \$ CALL

ATARI software, Roms, Cassettes \$ CALL

ATARI Expansion Memory: \$ CALL

8K Module or 16K Module \$ CALL

CALL for our lowest prices ever.

ZENITH DATA SYSTEMS: Smart Video Terminal



Z-19 has a Z80 Microprocessor, Numeric Keypad and 8 function key \$895.00



Z-89 Computer System: includes: Z19 Display, a built in 5 1/4" Floppy Disk, 2 serial ports, and 16K of memory. 2295.00
48K Memory version 2595.00

EPSON (A SEIKO COMPANY)

TX-80 Printer with 64 graphics characters
7x5 dot matrix (7x6 in graphics) Double width characters

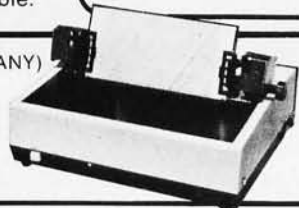

Tractor Feed Model \$745.00

Friction Feed Model \$695.00

TRS80 Interface & Cable \$50.00

Pet Interface & Cable \$90.00

APPLE Interface & Cable \$90.00

RS232 Interface & Cable \$90.00

Plastic Floppy Disk Holder

(up to 10) 8" \$3.95

(up to 10) 5" \$3.25

16K RAM set of 8 4116's 250 ns or better \$65.00

Prices subject to change without notice. VISA and MASTER CHARGE WELCOME (Add 3%). Allow 2 weeks for cashiers check to clear, 4 weeks for personal checks. Add 2% for shipping and handling. Calif. residents add 6% sales tax.

U.S. and International dealer inquiries invited.



MICRO BUSINESS WORLD
15818 Hawthorne Boulevard
Lawndale, California 90260
(213) 371-1660

Circle 278 on inquiry card.

SEND \$1.00 FOR 52 PAGE CATALOG

OUR BEST PRICE EVER!

MICROPOLIS™ DISK DRIVE SUBSYSTEMS

At Micropolis, complete means complete.

Some suppliers offer only hardware and call that complete. At Micropolis complete means everything: hardware and software and documentation.

The hardware set is complete with S-100/8080/Z-80 compatible controller, drive(s), cable—even a built-in Autoload bootstrap ROM to eliminate tiresome button pushing.

Our full Disk Extended BASIC and DOS, assembler and editor software comes complete, too. On its own diskette, ready to go. Software from Micropolis includes a DOS and Disk Extended Basic designed for 8080/Z80-based microcomputers.

DOS is a complete package, including an assembler, editor, file management functions and utilities, which provides total support for 8080 programming. BASIC is a self-contained package which provides a powerful set of tools for developing, testing, executing, and maintaining BASIC programs.

BASIC is designed for microcomputers with at least 24K bytes of RAM and a Micropolis MetaFloppy disk system. DOS can be used alone in a 16K bytes memory system.

Activating the built-in Auto load ROM brings up the system under control of the DOS executive. BASIC can be accessed by issuing a simple DOS command.

The 1053 MOD II Subsystem is designed for flexible, efficient programming. 8080 programs created under DOS can be loaded and accessed from BASIC. Data files created under BASIC can be processed by user written application programs running under the DOS.

At Micropolis, complete means **COMPLETE**.

Imagine getting all the capacity of an 8-inch floppy in a 5 1/4-inch format.

MetaFloppy can give you this higher capacity because it packs more data into every disk. You get the capacity of larger 8-inch drives with the lower price and smaller packaging of 5 1/4-inch drives.

An ordinary 5 1/4-inch floppy provides just 35 tracks/disk and stores only 70K bytes. Not nearly enough for anything useful. So instead, we use 77 tracks—each with 16 sectors of 256 bytes/sector—to yield a capacity of 315K bytes/disk. That's more than four times an ordinary 5 1/4-inch floppy! And why we call this one "quad density."

Combine two of these drives in a compact dual module and you can copy diskettes from one drive to the other, or rearrange data files, or whatever. The dual unit stores 630K bytes. Enough for almost anything. But just in case that isn't enough, our controller can handle two duals (or four singles). That means your micro can have more than a million bytes of formatted disk storage.

If that still isn't enough, on special order you can add a second controller with up to four more drives. That will give you a grand total of over 2,500,000 bytes of storage on-line. This means, if your application keeps growing, we've got you covered in easy steps. And you get all these bytes at surprisingly low cost.

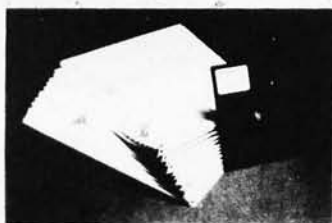

Each one of our floppy disks has a remarkable storage capacity, eliminating the need to keep bothersome stacks of paper.

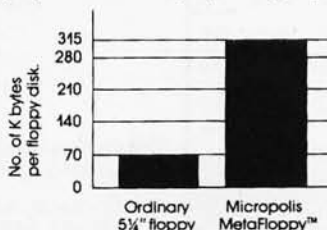

Faster than a speeding bullet.

At Micropolis, we don't skimp on performance to deliver maximum capacity. So you can expect professional operating speed and efficiency. Like checks and balances, such as automatic read verification after writing, that you would expect in a sophisticated data processing system.

Like fast track-to-track positioning time of only 30 milliseconds. And a data transfer rate of 250,000 bits per second.

Up, Up, and away!

Metafloppy gets along well with almost everyone.

So choose the microcomputer you want. MetaFloppy's controller is completely compatible with the S-100/8080/Z-80 bus. It just plugs into your MITS 8800, IMSAI 8080, COMPAL-80, SOL-20, Polymorphic 88, CROMEMCO, TDL, or similar micro and it's ready to go. The memory mapped controller/bootstrap may be originated at any 1K byte boundary in the 48K to 64K byte region of memory.

For small businesses, for engineers who want to develop their own software, or for the advanced hobbyist, MetaFloppy is ideal.

MCP-1053 MOD II

TWO DISK SYSTEM WITH 630,000 BYTES (FORMATTED) OF ON-LINE STORAGE CAPACITY.

LIST PRICE \$1895.00

SALE PRICED AT JUST \$1595.00

LIMITED TO SUPPLY ON HAND

PRIORITY ONE ELECTRONICS®

16723K Roscoe Blvd. Sepulveda, CA 91343

Terms: Visa, MC, BAC, Check, Money Order, C.O.D. U.S. Funds Only. CA residents add 6% sales tax. Minimum order \$10.00 Prepaid U.S. orders less than \$75.00 include 5% shipping and handling. MINIMUM \$2.50. Excess refunded. Just in case... please include your phone no.

Prices subject to change without notice.

We will do our best to maintain prices thru March 1980. OEM and Institutional phone orders welcome (213) 894-8171, (800) 423-5633. Inquiries invited.

800-423-5633

EXCEPT CA, AK, HI. (213) 894-8171

WE STOCK THE ENTIRE MICROPOLIS LINE CALL FOR PRICES

SEND \$1.00 FOR 52 PAGE CATALOG

Circle 215 on inquiry card.

4 MHZ EXPANDORAM II KIT

The S-100 Memory Board for the 80's

SD SYSTEMS' ExpandoRAM II is a state-of-the-art dynamic RAM board with capacities from 16K bytes (4116) to 256K bytes (4164). It operates on the industry S-100 Bus. The ExpandoRAM II's design allows eight boards to operate from the same S-100 Bus. Page mode operation provides the system with the capability of servicing multiple users without RAM interference. Invisible refresh and synchronization with wait states provide greater reliability, and processing speeds up to 4 Mhz.

The ExpandoRAM II is compatible with most S-100 CPU's based on the Z80 microprocessor. When other SD SYSTEMS 200 series boards are combined with the ExpandoRAM II, they create a microcomputer with exceptional capabilities and features.

- S-100 Bus Compatible
- Up to 4Mhz Operation
- Expandable Memory from 16K to 256K
- DIP Switch Selectable Boundaries
- Uses 16K (4115) or 64K (4164) Memory Devices
- Page Mode Operation Allows up to 8 Memory Boards on Bus
- Operates with Z80 CPU's
- Phantom Output Disable
- Invisible Refresh (Synchronized with Wait States)

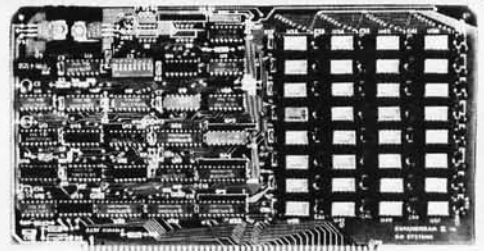

SDS - EXPANDOPRAM II KIT (4116)

	List Price	Sale Price	List Price	Sale Price
16K ...	\$460.00	\$295.00	48K ...	\$960.00
32K ...	\$710.00	\$370.00	64K ...	\$1210.00
				\$520.00

SEE OUR 52 PAGE DETACHABLE AD IN JANUARY BYTE

SEE OUR 52 PAGE DETACHABLE AD IN JANUARY BYTE

VCT-8803

MOTHER BOARD FOR S100 BUS MICRO-COMPUTERS

- Kit includes 12 tantalum capacitors for +5, +12, -12 buses and insulated mounting spacers.
- Working side shows component side bare epoxy glass with white markings for component locations.
- G10 epoxy glass board with 2 ounce copper, solder plated and 030 diameter holes for leads.
- Solder mask with solder windows on etched circuits to avoid accidental short circuits.
- Mounts 11 receptacles with 100 contacts (2 rows) on 125 centers with .250 row spacing. Vector part number 8681-2, or mounts 10 receptacles plus interconnections to smaller mother board for expansion.
- Includes etched circuits and instructions for option of active, pull-up, or floating terminations.
- Large buses: +5V and GND (10 AMPs), ±12V or 16V (7 AMPs). Current ratings are per MIL-STD-275 with 100°C rise.
- Fits in Vector-pak enclosures.
- Fits in IMSAI 8080 microcomputer as expander board.

Price: \$29.50

VCT8800V

Universal Microcomputer/processor plugboard, use with S-100 bus. Complete with heat sink & hardware. 5.3" x 10.1" x 1/16"

1-4	5-9	10-24
\$19.95	\$17.95	\$15.96

VCT8801-1

Same as 8800V except plain, less power buses & heat sink.

1-4	5-9	10-24
\$15.22	\$13.79	\$12.18

Vector Plugboards

VCT3677 9.6"x4.5" \$10.90

VCT3677-2 6.5"x4.5" \$9.74

Gen. Purpose D.I.P. Boards with Bus Pattern for Solder or Wire Wrap. Epoxy Glass 1/16" 44 pin con. spaced .156

VCT3682 9.6"x4.5" \$12.97

VCT3682-2 6.5"x4.5" \$9.81

Hi-Density Dual-In-Line Plugboard for Wire Wrap with Power & Grd. Bus. Epoxy Glass 1/16" 44 pin con. spaced .156

VCT3662 6.5"x4.5" \$8.95

VCT3662-2 6.5"x4.5" \$11.45

P pattern plugboards for IC's Epoxy Glass 1/16" 44 pin con. spaced .156.

VCT3690-12 CARD EXTENDER

Card Extender has 100 contacts 50 per side on .125 centers-Attached connector is compatible with S-100 Bus Systems. \$25.83

VCT3690 6.5"22/44 pin... \$156 ctrs.Extenders...\$13.17

S-100 BUS EDGE CONNECTORS

CG 1 (MSA) Style Card Guides \$21.00

GOLD S-100 CONNECTORS

TI-S100-STG SOLDER TAIL 5/8"10"00 or TI-S100-WWG WIRE WRAP 3/8"10"00

S100SEG 50/100 Cont .125 ctrs. PIERCED SOLDER EYELET Tails GOLD

1-9	10-24	25-99	1-9	10-24	25-99
\$6.80	\$6.10	\$5.45	\$4.95	\$4.45	\$3.95

Other Popular Edge Connectors

SUL-D2244-5WWG 22/44 Cont .156 ctrs.WIRE WRAP tails GOLD.

1-9	10-24	25-99	1-9	10-24	25-99
\$3.98	\$3.50	\$3.00	\$2.98	\$2.90	\$2.75

RS232 and "D" SUB-MINIATURE CONNECTORS

P = Plug, Male Type - S = Socket, Female Type - C = Cover, Hood

PART NO.	DESCRIPTION	PRICE	
		1-9	10-24 25-99
CND-DE9P	9 Pin Male	1.80	1.40 1.30
CND-DE9S	9 Pin Female	2.25	2.00 1.90
CND-DE9C	9 Pin Cover	1.50	1.35 1.20
CND-DA15P	15 Pin Male	2.35	2.15 2.00
CND-DA15S	15 Pin Female	3.25	3.10 2.90
CND-DA15C	15 Pin Cover	1.60	1.45 1.30
CND-DB25P	25 Pin Male	2.80	2.60 2.40
CND-DB25S	25 Pin Female	3.60	3.40 3.20
CND-DB51212-1	1 pc Grey Hood	1.50	1.30 1.10
CND-DB110963-3	2 pc Grey Hood	1.75	1.55 1.35
CND-DB1228-1A	2 pc Black Hood	1.90	1.85 1.45
CND-DC37P	37 Pin Male	4.20	4.00 3.70
CND-DC37S	37 Pin Female	6.00	5.75 5.50
CND-DC37C	37 Pin Cover	2.25	2.00 1.75
CND-DD50P	50 Pin Male	5.50	5.10 4.75
CND-DD50S	50 Pin Female	9.40	8.80 8.00
CND-DD50C	50 Pin Cover	2.40	2.20 2.00
D2041B-S	Hardware Set 2 pr.	1.00	.80 .70
CND-RS232-8FT	RS232, DB25P, EIA class 1 cable 8 con. 8 ft. long Centronics 700 Series printer connector	18.00	16.00 14.00
CND-57-30360		9.00	7.50 6.00

1/16 Vector BOARD .042 dia holes on 0.1 spacing for IC's

Phenolic

PART NO.	SIZE	PRICE
VCT64P44XXXP	4.5x6.5"	\$1.56 \$1.40
VCT169P44XXXP	4.5x17"	\$3.69 \$3.32

Epoxy Glass

PART NO.	SIZE	PRICE
VCT64P44	4.5x6.5"	\$1.79 \$1.61
VCT84P44	4.5x8.5"	\$2.21 \$1.99
VCT169P44	4.5x17"	\$4.52 \$4.07
VCT169P84	8.5x17"	\$8.83 \$7.95

3 LEVEL GOLD WIRE WRAP SOCKETS

PART NO.	PINS	1-9	10-24	25-99	100-249	250-999
RNS-08WWG	8	.40	.36	.34	.31	.27
RNS-14WWG	14	.50	.39	.37	.35	.32
RNS-16WWG	16	.55	.42	.40	.37	.34
RNS-18WWG	18	.75	.65	.60	.55	.50
RNS-20WWG	20	.90	.80	.70	.65	.62
RNS-22WWG	22	1.00	.90	.85	.80	.75
RNS-24WWG	24	1.00	.90	.85	.80	.75
RNS-28WWG	28	1.40	1.30	1.25	1.10	1.00
RNS-40WWG	40	1.65	1.45	1.35	1.25	1.20

*Price based on gold not exceeding \$400.00 per oz.

3M SCOTCH® BRAND DISKETTES

Part No.	Sides	Density	Sectoring	Price Box of 10
740 OK	1	triple	Soft IBM	\$39.95
740Z OK	2	triple	Soft IBM	\$75.00
740-32K	1	triple	32	\$39.95
740Z-32K	2	triple	32	\$75.00
741-0	1	triple	tridouble	\$59.00
744 OK	1	triple	Soft (TRS-80)	\$39.95*
744-10K	1	triple	Soft10	\$39.95*
744-10K	1	triple	Soft16	\$39.95*

"DON'T SETTLE FOR ANYTHING LESS THAN SCOTCH"

ROCKWELL AIM-65

The Rockwell AIM 65 with 4K RCK-AIM65-4K 8 lbs..... **\$445.00**

The Rockwell AIM 65 with 1K RCK-AIM65 1K 8 lbs..... **\$395.00**

4K Assembled--RCK-AIM65-010..... **\$ 85.00**

8K Basic in ROM--RCK-AIM65-020..... **\$100.00**

NOVATION CAT ACOUSTIC MODEM

\$174.95 Regular \$198.00

- 0-300 Baud
- Bell 103
- Answer, Originate

TRS-80/APPLE MEMORY EXPANSION KITS

from Leading Manufacturers-(16Kx1 200/250ns) 4116's RAMS

8 for \$65.00

Add \$3.00 for programming Jumpers for TRS-80 Keyboard

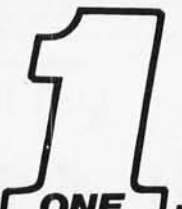

DEALERS CALL FOR

MEMORY MEMORY

2102LIPC Low Power 450ns in lots of 20	\$1.10
2102AL-2 Low Power 250ns in lots of 20	\$1.25
2114-3L 1Kx4 300ns Low Power	8/\$50.00
5257-3L 4Kx1 300ns Low Power	8/\$50.00
2708 8K 450ns EPROM	8/\$60.00 - \$8.50 ea
2716 16K 5 Volt only EPROM	8/\$240-\$32.00 ea

PRICING

Vector WRAP POST

for .042 dia. holes (all boards on this page) T44/C pkg. 100 ... \$ 2.34 T44/M pkg. 1000 \$14.35 A-13 hand installing tool \$ 4.19

PRIORITY ONE ELECTRONICS®

16723 Roscoe Blvd. Sepulveda, CA 91343

Terms: Visa, MC, BAC, Check, Money Order, C.O.D. U.S. Funds Only. CA residents add 6% sales tax. Minimum order \$10.00 Prepaid U.S. orders less than \$75.00 include 5% shipping and handling, MINIMUM \$2.50. Excess refunded. Just in case... please include your phone no.

Prices subject to change without notice. We will do our best to maintain prices thru March 1980

phone orders welcome (213) 894-8171, (800) 423-5633

OEM and Institutional inquiries invited.

ORDER TOLL FREE 1-800-423-5633

except CA., AK., HI., CALL (213) 894-8171

Circle 216 on inquiry card.

SEE OUR 52 PAGE DETACHABLE AD IN JANUARY BYTE

DISC DRIVES

SHUGART SA 400 5 1/4"
10MB 30 tracks
SHUGART SA 400 \$295.00

SHUGART SA 400
with attractive price extra with
SHUGART SA 400 5 1/4" Disk Switch
Disk and power cord
10MB 30 tracks \$325.00

SHUGART SA400
with Cabinet and Power Supply
Assembling, Testing & Guaranteed
10MB 30 tracks \$395.00

SHUGART 8018 B
8 1/2 megabyte single or double
density hard or soft sector, write
protect, and more
SHUGART 8018 \$495.00
SHUGART 8018 B \$595.00
SHUGART 8018 B \$695.00



SD EXPANDORAM The Ultimate S-100 Memory

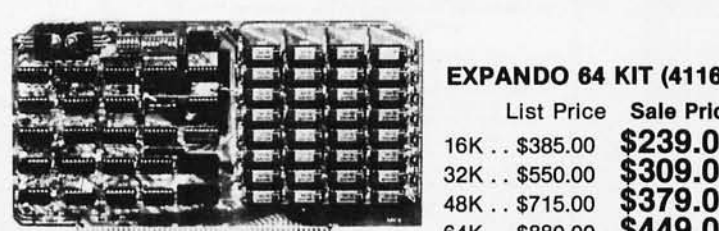

EXPANDO 64 KIT (4116):

	List Price	Sale Price
16K ..	\$385.00	\$239.00
32K ..	\$550.00	\$309.00
48K ..	\$715.00	\$379.00
64K ..	\$880.00	\$449.00

The EXPANDORAM is available in versions from 16K up to 64K, so for a minimum investment you can have a memory system that will grow with your needs. This is a dynamic memory with the invisible on-board refresh, and IT WORKS!

- Interfaces with Altair, IMSAI, SOL-8, Cromenco, SBC-100, and others.
- Bank Selectable Phantom
- Power 8VDC, ± 16VDC, 5 Watts
- Lowest Cost Per Bit
- Uses Popular 4116 RAMS
- PC Board is double solder masked and has silk-screen parts layout.

Extensive documentation clearly written Complete Kit includes all Sockets for 64K Memory access time: 375ns, Cycle time: 500ns. No wait states required. 16K boundaries and Protection via Dip Switches Designed to work with Z-80, 8080, 8050 CPU's

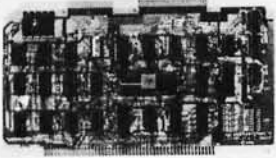

VERSASFLOPPY II
DOUBLE DENSITY, DOUBLE SIDED, DISC CONTROLLER

DISC CONTROLLER SD "VERSASFLOPPY" KIT

The Versatile Floppy Disk Controller List Price \$250.00

SALE PRICE \$189.95

FEATURES: IBM 3740 Soft Sector Controller for S-100 BUS Compatible for Z80 or 8080 Controls up to 4 Drives (single or double sided soft sector) Directly controls the following drives:
1. Shugart SA400 5 1/4" Standard Floppy
2. Shugart SA400 5 1/4" Standard Floppy
3. PERDISC 70 and 277
4. MFE 100/50
5. CDC 5404/406
6. Commodore DD102A
34 Pin Connector for Mini Floppy, 30 Pin Connector for Standard Floppy. Operates with standard operating system and C device Controller. The new "Versafloppy" from SD Controller Products provides complete control for many of the available Floppy Disk Drives. Both Mini and Full Size (5 1/4") Single Density, Controller Chip Listings for Control Software are included in price. CPM for SD Versafloppy \$100.00

SHOP & COMPARE SPECIAL

M-XVI

The true 16K Static Ram module for S-100 bus systems

Assembled & Tested 100% Burn In

The M-XVI gives you unbelievable expansion capability for your S-100 bus system even beyond 64K. Manufactured to the highest industry standards documented and designed to make assembly, use, and programming a snap. The M-XVI board is a true revelation for the serious hobbyist and use in practical business or industrial applications.

FEATURES:
• Fully static
• Uses popular 2114 static RAMS
• ± 5 volt operation only
• Bank Select available by bank port and bank byte
• Phantom line capability
• Addressable in 4K blocks
• 4K blocks can be addressed anywhere within 64K in 4K increments
• Meets IEEE proposed S-100 signal standards
• LED indicators for board selection and bank selection
• FR-4 epoxy PC boards
• Solder masked on both sides
• Silk screen of part number and part designator

Sale Priced

2016BA 450ns 2MHZ	Reg. \$349.95	\$279.95
2016BB 300ns 4MHZ	Reg. \$389.95	\$309.95
2016BX Bare Board only		\$29.95



VERSASFLOPPY II

DOUBLE DENSITY, DOUBLE SIDED, DISC CONTROLLER



SDS-VERSASFLOPPY II KIT List Price \$350.00 Sale Price **\$325.95**

GENERAL DESCRIPTION: Versafloppy II is a flexible disk drive controller that incorporates a wide range of capabilities into one board. It operates with double density soft sector format which provides 965,600 bytes of storage on a double sided 8 inch diskette and 129,600 bytes per side on a five inch mini-diskette. The Versafloppy II directly controls many popular disk drives. These include: Shugart SA400 and SA450, Shugart SA800 and SA850, Mayflower MFE500 and MFE700, Per Sci 70 and 277, and Siemens 855-105.

- S-100 Bus IEEE Standard Compatible
- IBM-3740 Compatible Soft Sector Format for Single Density Drives
- Operates with both Standard (8") and Mini (5") Drives Simultaneously
- Provides Control for Double Sided Operation
- Operates with Z80, 8080, and 8085 Central Processing Unit
- Controls up to four drives
- Vectored Interrupt Operation
- Optional Control and Diagnostic Software Available in PROM
- SDOOS Disk Operating System Compatible

CENTRONICS 730 Dot Matrix Printer

SAVE \$150.00

STANDARD FEATURES: • 50 Characters/second • Characters/line • 10 characters/inch • 3-way paper handling system • 7 x 7 dot matrix • 96 character ASCII • microprocessor electronics • undirection print at 5.0 ips • high speed return approximately 10 ips • 21 lpm with 80 columns printed • 58 lpm with 20 columns printed • 60 character buffer • 6 lpi vertical • Centronics Colors and logo

FORMS HANDLING: Roll Paper: 8.5 in. x 5.0 dia. with 1 in. core maximum dimension. 3.5 in. wide with .38 in. core minimum dimension. Fan Fold: 9.0 in. x 22.9 cm. wide pin to pin 9.5 in. x 24.1cm wide overall. Up to 3 ply paper with 2 carbons (total thickness not to exceed .012 inches) Cut Sheet: Maximum width 8.5 inches.

RIBBON SYSTEM: Continuous ribbon 9/16" (14mm) wide, 20 yards (18.3 meters) long. Medium Loop allows printing on upper and lower portion on alternate passes.

OPERATOR CONTROLS: Power on/off. Reset Switch - allows disabling of printer without dropping AC.

DATA INPUT: 7 or 8 bit ASCII parallel, TTL levels with strobe. Acknowledge pulse indicates that data was received.

PHYSICAL DIMENSIONS: Weight: less than 10 lbs./5 kg. Width: 14.5 inches/37 cm. Depth: 11.0 inches/28cm - Height: 4.89 inches/13cm - Dimensions exclusive of roll paper holder.

SHIPPING WEIGHT: 14 lbs.

CEN-730-1 (Parallel Int.) LIST PRICE: \$995.00

PRICE \$850.00



SINGLE BOARD COMPUTER

With On-Board RAM, PROM, CTC

- S-100 Bus Compatible
- Z80 Central Processing Unit
- 1024 Bytes of Random Access Memory
- 8K Bytes of PROM using 2716
- Parallel Input and Output Ports
- Four Channel Counter/Timer (Z80-CTC)
- Software Programmable Baud Rate Generator
- No Front Panel Required for Operation

	List Price	Sale Price
SDS-SBC-100 2MHZ KIT	\$295.00	\$249.95
SDS-SBC-200 4MHZ KIT	\$320.00	\$289.95

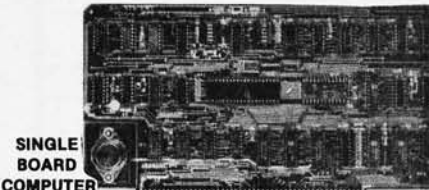

VDB-8024 VIDEO DISPLAY BOARD

With on-board Z80 Microprocessor

- S-100 bus Compatible
- Full 80 Characters by 24 Lines Display
- Characters Displayed by High Resolution 7 x 10 Matrix
- Composite or TTL Video Output
- Keyboard Power and Interface
- Forward and Reverse Scrolling Capability
- Blinking, Underlining, Field Reverse, Field Protect and Combinations
- Full Cursor Control
- 96 Upper and Lower Case Characters
- 32 Special Character Set
- 128 Additional User Programmable Characters (Optional)
- On-Board Z80 Microprocessor
- 2K Bytes Independent On-Board RAM Memory
- Glitch-Free Display

	List Price	Sale Price
SDS-VDB-8024 KIT	\$370.00	\$329.95

PROM-100

Programming Board for PROM Development

NEW

SD SYSTEMS' PROM-100 is a versatile PROM programming board offering complete EPROM programming capability. The board operates on the industry standard S-100 Bus. Support software verifies the erasure of EPROM and verifies the loaded program. SD SYSTEMS' PROM-100 offers a support-software listing with its operations manual.

- S-100 Bus Compatible
- Programs the Following EPROM s: 2708, Intel 2758, 2716, 2732 and Texas Instruments 2516
- Dip Switch Selection of EPROM type
- 25 VDC Programming Pulse Generated On Board
- Maximum Programming time: 16,384 Bits in 100 Seconds
- Power Requirement: + 8VDC at 300 ma.; + 16 VDC at 100 ma.; - 16 VDC at 60 ma.
- TTL compatible
- Software Provides for Reading of Object File from SDOOS, CPM or PROM and Programming into EPROM
- Program Verification • Verification of Erasure
- Zero Insertion Force Socket

	List Price	Sale Price
SDS-PROM-100 KIT	\$200.00	\$175.00

Z80 STARTER KIT

A Complete Microcomputer On A Board

- Z80 CPU with 158 Instructions
- On-Board Keyboard and Display
- On-Board PROM Programmer for Single Voltage PROMS (2716, 2758, TI2516)
- Kansas City Standard Cassette Interface
- Simple Key Controlled Audio Cassette Load and Dump
- Expansion Provision for Mounting Two S-100 Connectors (Sockets Not Included)
- Wire Wrap Area for Custom Circuitry
- Single Step through RAM or PROM
- Memory Examine and Change
- Port Examine and Change
- Z80 CPU Register and Change
- 2K Byte ZBUG Monitor in ROM
- 1K Bytes of RAM (Expandable to 2K Bytes)
- A 4 Channel Hardware Counter/Timer (Z80-CTC)
- Two Bi-Directional 8-Bit I/O Ports (Z80-P10)
- Up to 5 Programmable Breakpoints
- Switch Selectable PROM or Monitor Restart
- Vectored Interrupts provided by Z80-CTC and

	List Price	Sale Price
SDS-Z80 STARTER KIT	\$340.00	\$279.95

Circle 216 on inquiry card.

PRIORITY ONE ELECTRONICS

16723 Roscoe Blvd. Sepulveda, CA 91343

Terms: Visa, MC, BAC, Check, Money Order, C.O.D. U.S. Funds Only. CA residents add 6% sales tax. Minimum order \$10.00. Prepaid U.S. orders less than \$75.00 include 5% shipping and handling. MINIMUM \$2.50. Excess refunded. Just in case... please include your phone no.

Prices subject to change without notice.

We will do our best to maintain prices thru March 1980

phone orders welcome (213) 894-8171, (800) 423-5633 OEM and Institutional Inquiries Invited.

800-423-5633 EXCEPT CA, AK, HI. (213) 894-8171

SEE OUR 52 PAGE DETACHABLE AD IN JANUARY BYTE

Dial: 402-987-3771

HOTLINE

YOU NEED CRISP, HIGH CONTRAST BLACK-WHITE and VIVID COLOR ALPHA-NUMERICS/GRAPHS CAPABILITIES FROM YOUR VIDEO MONITOR IF YOU WANT REALLY SUPER-LOOKING IMAGES FROM YOUR COMPUTER!!

AS SPECIALISTS IN VIDEO IMAGING...we think we have the right monitor or modulator for your system. Our product line includes the popular "Micro-Verter" (OSI and Apple Inc. approved UHF color modulator), a variety of color and B-W monitors, color cameras, B-W cameras, Audio subcarrier kits and parts. FREE CATALOG UPON REQUEST. Dealers welcomed. We'll establish program with over 400 dealers.

GET FREE DETAILS VIA OUR HOTLINE!!!

ATV Research 13-B BROADWAY DAKOTA CITY, NE. 68731

Circle 217 on inquiry card.

Save More Than 20%
North Star—Intertek
Thinker Toys—Microtek
The Smartest Computers at the Smartest Price
Quad & Double Density

	List	Only
Horizon-1-32K-D Kit	\$1999	\$1589
Horizon-2-32K-D Kit	2399	1909
Assembled & Tested	2765	2199
Horizon-2-32K Kit Quad	2799	2229
Assembled & Tested	3215	2559
Pascal for North Star on Disk		49
Powerful North Star BASIC		FREE
ZTEI PT 212 Computer 5 MHz	8000	6250
Thinker Toys Discus/2D A&T	1149	949
Dusous/2 + 2 1.2 Megabytes A&T	1549	1299
Measurement system memory		640
A&T 4MHz 64 K		
Godbout Memory	Call for price	
Intertube II Smart Terminal	995	749
Microtek Printer	750	679
Anadex Printer	995	879
Florida Data Printer 600 CPS 4300	Call for price	
Maryellen Word Processor Your Best Buy	35	
Textwriter III	125	
EZ-80 Tutorial Learn Machine Language	25	
PDS For North Star Better Than CP/M	99	
Compiler for Horizon Secret Superfast Code	100	
10% Off Software Prices With Computers		
Verbatim the Best Diskettes Box of 10	99	
Which Computers Are Best? Brochure...	FREE	
North Star Documentation Refundable	20	
W/HRZ		

American Square Computers
Kivett Dr • Jamestown NC 27282
(919)-885-1105

Circle 218 on inquiry card.

Texas Instrument 99-4 Computer \$ 990.
T1810 Printer \$1590.

Centronic Printers:

730-1 Parallel	\$ 799.
730-2 Serial	\$ 859.
779-1 Friction Feed	\$ 959.
779-2 Tractor Feed	\$ 999.
Comprint 912 Par	\$ 475.
912 Ser	549.
Anadex with Par & Serial Interface	\$ 799.

Commodore Business Machines:

PET 2001-8K Computer	\$ 695.
PET 2001-16K	\$ 895.
PET 2001-32K	\$1090.
PET 2022 Trac. Fed Printer	\$ 899.
PET 2023 Frig. Fed	\$799.

\$75. Free Software with PET Machines

Intertec Superbrain
North Star Computer and Acc.
** Save \$ Save \$ **

Display Terminals:

Intertube II	\$ 775.
Hazeltine 1400	\$ 690.
1410	\$ 785.
1500	\$ 990.

Immediate Delivery from Stock.

Multi-Business Computer System
28 Marlborough Street
Portland, Conn. 06480
(203) 342-2747

Circle 324 on inquiry card.

TRS-80 Model I and II quality software

DATA BASE MANAGER IDM-IV \$69
You can use it to maintain a data base & produce reports without any programming. Define file parameters & report formats on-line. Features key random access. Fast multi-key sort. Field arithmetic. Label generator. Audit log. MOD-II version with more than 50 enhancements \$199

ACCOUNTS RECEIVABLE ACCT-III \$69
One or more drives. Order entry calculates sales tax, shipping amount for multiple items. Credit checking, aging, sales analysis, invoices, statements and reports. As opposed to most other A/R, ours can be used by doctors, store managers, etc. MOD-II version \$149

WORD PROCESSOR 16K \$39 32K \$49 MOD-II \$49
First word processor specifically designed for the TRS-80 that uses disk storage for text. Written in BASIC. No special hardware and text limit. Use for letters, manuals & reports. 32K version features upper/lower case without hardware change and multiple input text files.

MAILING LIST advanced MAIL-V \$59
Fast sort by any field. Multiple labels and reports. 4-digit selection code. New zip code ext. screen input. Live keyboard. Powerful report writer. MOD-II \$99

INVENTORY INV-V \$99
9-digit alphanumeric key for fast key random access. Reports include order info, performance summary, etc. Calculate E.O.Q. Powerful report writer. MOD-II \$149

All programs are on-line, interactive, random access, virtually bug free, documented and delivered on disks. MOD-I requires 32K, DOS. We challenge all software vendors to offer low cost manuals so you can compare and avoid those high-priced undocumented, on-memory programs. Send \$5 for a MOD-I manual and \$10 for MOD-II

MOD-II programs are extensively modified, guaranteed to run with 1 year newsletter & updates. 10% off for ordering more than 1 MOD-II programs

MICRO ARCHITECT
96 Dothan St., Arlington, MA 02174

Circle 219 on inquiry card.

C-10 SHORT CASSETTES 50 FT.

Qty.	Price
1	\$1.00
10	\$0.75
50	\$0.65

Premium tape and cassettes acclaimed by thousands of repeat order microcomputer users. Price includes labels, cassette box and shipping in U.S.A. VISA and M/C orders accepted. California residents add sales tax. Phone (415) 968-1604.

MICROSETTE CO.
475 Ellis Street
Mt. View, CA 94043

Circle 220 on inquiry card.

NEW S-100 A/D

- S-100 Bus Compatible A/D Converter
- 12 Bit Accuracy
- 16 Channel Analog Input
- Programmable Gain Amplifier with Sample-and-Hold
- High Quality Commercial/Industrial Construction

2 and 4 Channel, 12 Bit D/A Boards also available.

CDC CALIFORNIA DATA CORPORATION
3475 Old Conejo Road, Suite C10
Newbury Park, California 91320
(805) 498-3651

Circle 221 on inquiry card.

New from Vantage Data Products

550 West 200 South
Suite 8
Provo, Utah 84601
(801) 377-6687

Communications/Control CPU Card

- CPU - Z-80 1K RAM
16 bit interval timer and interrupt
EPROM * 2708 standard (2716 optional)
- Serial Communications-RS-232 interface,
UART Complete MODEM capability,
programmable baud rates, etc.
- Parallel I/O - 16 bits in (TTL), 16 bits Out (TTL)
- Power - on and external reset
* EPROM not included

\$195 assembled, tested, with warranty and documentation

Immediate delivery from stock!
All orders shipped prepaid
MC, VISA, phone orders welcome
Utah residents add 4 3/4% sales tax

Circle 222 on inquiry card.

THE SWITCH

OPTO ISOLATED 120 VAC SOLID STATE SWITCH

- INPUT 5 VDC 2 MA (TTL)
- ISOLATION 1500 VDC
- OUTPUT 6 A 120 VAC 720 W
- SIZE 2 x 2 1 CHANNEL
- SIZE 2 x 8 4 CHANNEL

PRICE KIT TESTED UNIT

1 CH.	\$9.95	\$12.50
4 CH.	\$34.95	\$44.95

ADD 6% SALES TAX IN CALIFORNIA AND \$1.00 SHIPPING & HANDLING FOR ORDERS LESS THAN \$20. ADD 4% FOR VISA OR M.C.

JOHN J. BELL
P.O. BOX 338
REDWOOD CITY, CA 94064
(415) 367-1137

Circle 223 on inquiry card.

STOP

SEARCHING THROUGH YOUR ENTIRE
NORTH STAR
BASIC PROGRAM LISTINGS.

WITH OUR NEW "SCAN" COMMAND YOU CAN INSTANTLY DISPLAY OR PRINT -

- ALL LINES THAT CONTAIN A SELECTED VARIABLE.
- ALL OCCURRENCES OF GOSUB OR GOTO TO A PARTICULAR LINE NUMBER.
- ALL REFERENCES TO ANY LINE NUMBER
- ALL OCCURRENCES OF ANY CHARACTER, NUMBER, LINE NUMBER, GROUP OF CHARACTERS OR ANYTHING THAT IS CONTAINED IN ANY BASIC LINE.

This is not one of those "funny programs written in BASIC." It is a machine language addition to BASIC that rewrites completely within NORTH STAR BASIC. It will not affect normal BASIC or DOS. It is self loading and can be loaded separately to operate with BASIC or saved along with BASIC as a copy of BASIC with the "Scan" command. Does not change memory available to BASIC. Easy to understand instructions.

- Available for version 6 as well as 14 digit basic
- State your version when ordering
- Dealer inquiries invited

PHONE ORDERS ACCEPTED **ONLY \$2750** (Disk) (California residents add 6% tax)
USE YOUR VISA OR MASTERCARD CARD

ELECTRONIC TECHNICIANS
SOFTWARE SERVICES
1072 CASITAS PASS RD.
CARPINTERIA, CA 93013
805-684-2541

Circle 224 on inquiry card.

10-DAY FREE TRIAL

Send for our
FREE Catalog



\$100 FREE ACCESSORIES WITH 16K or 32K PET

When you buy a 16K or 32K PET, apply \$100 toward PET accessories, FREE! Just indicate on your order that you have reduced the cost of your accessories by \$100.

FREE Terminal Package with 8K PETs
See Special Below

SAVE \$98

PET ACCESSORIES

Commodore Dual Floppy Disk Drive	\$1,295.00
Commodore Printer (friction feed)	\$849.00
Commodore Printer (tractor feed)	\$995.00
Second Cassette-from Commodore	\$95.00
Commodore PET Service Kit	\$30.00
Beeper-Tells when tape is loaded	\$24.95
Petunia-Play music from PET	\$29.95
Video Buffer-Attach another CRT	\$29.95
Combo-Petunia and Video Buffer	\$49.95
TNW Bi-dir. RS-232 printer X-face (see box below)	\$229
KIM 1 (A Single Board Computer from Commodore)	\$179.00

8K-Keyboard N	\$795
16K-Keyboard B	\$995
16K-Keyboard N	\$995
32K-Keyboard B	\$1,295
32K-Keyboard N	\$1,295

B—large keyboard (graphics not on keys)
N—large keyboard with graphics symbols

SANYO MONITORS

SALE!

9-inch
\$169



SALE!

15-inch
\$279

Perfect for PET & APPLE Owners...
Sanyo cassette recorder... \$55

apple II
plus

\$200 FREE ACCESSORIES

The new Apple II with Applesoft BASIC built-in! Eliminates the need for a \$200 Firmware Card and includes new Autostart ROM for easy operation. This combined with the FREE accessories from NCE could save you up to \$400 on a 48K Apple II system!

16K Apple II Plus—\$1195 (take \$100 in free accessories)
32K Apple II Plus—\$1345 (take \$150 in free accessories)
48K Apple II Plus—\$1495 (take \$200 in free accessories)

Apple II Accessories	
General Business	\$625
PASCAL	\$495
Integer BASIC ROM Card	\$200
VISI-Calc	\$99
Centronics Printer Interface	\$225
Disk and Controller	\$595
Parallel Printer Card	\$180
Communications Card	\$225
Hi-Speed Serial Card	\$195
Firmware Card	\$200

Hazeltine

Super Terminal Sale!

1410 Reg. \$900 1500 Reg. \$1,069
SALE! \$749 **SALE! \$995**

PAPER TIGER 440SPE

The Graphics Printer for Apple II

Now you can print illustrations, block letters, charts, graphs, and more—all under software control. And with the expanded buffer, the Paper Tiger can hold the text from an entire 24-line-by-80-column CRT screen.
\$1194.00 440 Reg. w/o graphics: \$995

REMOTE TERMINAL

for only \$98

A self-contained module and program cassette enables your PET to function as a 300 baud terminal. Supports Upper/Lower case, Rubout, Escape and all control functions. Output is TTL. Can be used with THE SOURCE. You will need the Terminal Option, Cat Coupler & EIA Cable to do this. Complete package which includes all 3 avail. from CompuMart for \$279.

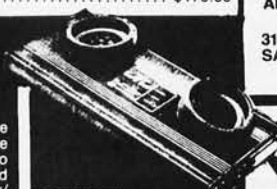

CAT
COUPLER

New 300 baud Originate/Answer Acoustic Coupler Looks good, works great

FREE WITH PET PURCHASE

SALE \$179

Excellent Performance—Looks Great The TNW-2000

Bi-Directional RS-232 Serial Interface

Interface your PET to printers, modems, CRT terminals, plotters, paper tape readers and punches—or other computers. The TNW-2000 Serial Interface lets you connect your PET to RS-232 serial devices. Comes assembled and tested with cable to connect unit to an IEEE Standard or Commodore PET connector.
TNW Bi-Dir. RS-232 printer X-face \$229

HEATH

The All-In-One Computer

Dual Z-80 Processors • Built-in 102K Floppy Disk • 16K to 48K RAM • 25 x 80 Character Display • Upper/Lower Case and Line Graphics • 80 Character Keyboard with Keypad • 8 User-definable Keys • Two BASIC's and Auto-Scribe Word Processing available • Can support CP/M

WH89 with 16K RAM	\$2,295
WH89 with 32K RAM	\$2,445
WH89 with 48K RAM	\$2,595
WH17 Second Disk Drive	\$550
Dual-port Serial Interface	\$85
HDOS Operating System	\$100
Microsoft BASIC	\$100
Word Processing	\$395

Lear Siegler's ADM-3A

The ADM-3A is industry's favorite dumb terminal for some very smart reasons:

- 12 in. diagonal screen
- Full or half duplex operation at 11 selectable data rates
- 1920 easy-to-read characters in 24 rows of 80 letters
- Typewriter-style keyboard
- RS-232 C interface extension port
- Direct cursor addressing



Our Low Sale Price \$795

CompuMart has the following Lear Siegler products in-stock. Call for complete specs, options, & special OEM prices:

ADM-31 • High resolution • Full editing capabilities • 90 key keyboard. • All 128 ASCII characters.

ADM-31 SALE! \$1,195 Reg. Price \$1,450

ADM-42. The low-cost, semi-intelligent video display terminal that provides total flexibility of format, editing, interface & transmission. 2 pg. display expandable to 8. Detachable keyboard.

ADM-42 SALE! \$1,595 Reg. Price \$1,795

310 Ballistic Printer. Long-Life, Exceptional Quality.
SALE! \$1995 Reg. Price \$2,045

NEW! ZENITH COLOR VIDEO MONITOR

Zenith's first color video display designed specifically for computers.

This 13-inch monitor is Zenith's first color video display designed specifically for computers. Features include automatic color level, color processing and degaussing circuits.

Zenith Color Monitor \$499.00

WE'VE GOT IT!
A Calculator, A System, A Whole New Standard.

HEWLETT-PACKARD'S HP-41C.

130 built-in functions • Alpha capability • 400 lines expandable up to 2,000 of program memory • Continuous memory • RPN logic.
"Customize It. Reassign any program or standard function to any keyboard location you want."
Enhanced programmability. Up to 6 levels of subroutines; 10 conditionals, 56 internal flags, specific loop control, indirect addressing, local & global branching. **HP-41C Calc. \$288**

THE SYSTEM.

Memory Modules. Increase capacity to 319 registers or 2,000 lines. **\$45.**

"Extra smart" Card Reader. Records programs & data onto blank mag-cards. **\$180.**

The Printer. Portable, quiet, thermal operation. Upper & lower case; plotting routines. **\$320.**

Application Modules (**\$45 ea.**) Standard Pac ROM, Statistics ROM, Math ROM, Financial Decisions ROM, Surveying ROM.

NCE/CompuMart has the following quality Hewlett-Packard scientific and business calculators in stock. Call for complete product info and specs:

HP-31E-Scientific, \$49.95 • HP-32E-Advanced scientific, \$66.95 • HP-33E-Programmable scientific, \$79.95 • HP-37E-Business management, \$69.95 • HP-38E-Advanced financial, \$108

CONTINUOUS MEMORY CALCULATORS
HP-33C-\$114.95, HP-34C-\$144.95, HP-38C-\$144.95

NCE/CompuMart SINCE 1971

DEPT BY30, 270 THIRD ST.,
CAMBRIDGE, MA 02142

To Order: **1 (800) 343-5504**

in Mass.: **1 (617) 491-2700**



Member:
Computer Dealers
Association

IMPORTANT ORDERING INFORMATION

All orders must include 4% shipping and handling. Mass. residents add 5% sales tax; Mich. residents 4%, for sales tax.

Phones open from 8:30 a.m. to 5:30 p.m. EST Mon.-Fri. • P.O.'s accepted from D&B rated companies — shipment contingent upon receipt of signed purchase order • Sorry no C.O.D.s • All prices are subject to change without notice • Most items in stock for immediate shipment — call for delivery quotation • In the Ann Arbor area? Our retail store is open 11:00 a.m. to 7:00 p.m. Tues.-Fri., 10:00 a.m. to 5:00 p.m. Saturdays (closed Sun. and Mon.)

If not satisfied, return your purchase with-in 10 days for full refund of purchase price!

LEADER Instruments Corp. OSCILLOSCOPES 2 YEAR WARRANTY



Model LBO-507

20 MHz, TRIGGERED
 ■ Single trace; automatic trigger for highly stable, bright display.
 ■ 17.5nSec rise time. ■ 10mV/cm to 20V/cm Vertical Sensitivity; 11 steps.



Model LBO-508

20 MHz, DUAL TRACE
 ■ Add, subtract modes on CH-1 & CH-2 facilitate easy checkout for simultaneous pulses, signal levels, distortion & noise cancelling.



Model LBO-515

25 MHz, DELAYED SWEEP, DUAL TRACE
 ■ Built in variable delay circuitry — 1µSec to 5 Sec. ■ 5mV/Div. Vertical Sensitivity.



Model LBO-520

30 MHz, FIXED DELAY, DUAL TRACE
 ■ Dual trace, 30 MHz bandwidth.
 ■ 5mV/cm Vertical Sensitivity.

COLOR BAR GENERATORS, BRIDGES, TESTERS.

NTSC Color Bar Pattern Generator



Model LCG-396

- NTSC color bars
- Provides full-field or IQW insertion, plus on-off control of chroma and luminance
- Better checking and adjusting of purity and white balance via red, blue, green, white raster
- Dots and single crossbars for convergence, raster and all other alignment requirements
- 7511 video (1 Volt f-kef) and RF output for TV and VTR equipment
- Equalizing pulse phase locked to color sub-carrier
- Adjustable scanning control permits progressive or interlaced scanning to eliminate flicker
- Provides all signals required to time, test & evaluate all MATV, CATV, VTR, VCR, color and B&W systems

Completely Portable, Battery Operated TV Color Analyzer

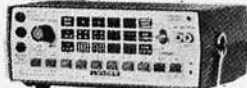

Model LCG-397

- RF, IF, composite video outputs
- 0-100% variable color burst for easy chroma service
- 18 convergence patterns — 10 bar gated, 3 bar gated and rainbow patterns
- 3 dot patterns, 2 crosshatch patterns
- 3 vertical lines and 3 horizontal lines plus gray scale
- Oscilloscope trigger outputs
- Battery operated: 4 standard "C" cells, 1.5V each.

Transistorized LCR Bridge



Model LCR-740

- Highly accurate 3 digit readout
- Measures Inductance (L), Capacitance (C) and Resistance (R), within - 0.5% accuracy
- Readouts variable with built-in 10% overrange
- Loss Factor scale (D)
- Operates on 1.9V battery or through built-in AC adapter

The Automatic Transistor Checker



Model LTC-906

- Automatically checks transistors, FET's, diodes, good/bad, in or out of circuit
- Automatically identifies Germanium or Silicon
- Automatically identifies elements
- Automatically tests broad range of parameters with simple program on/off switches
- LED display plus audible tone indicates defective or good performance
- Absolute meter readout of H_{FE} , B_{DC} and Leakage current
- Totally portable, battery operated — 9V battery

Before you buy, check our prices...

Call TOLL FREE (800) 645-9518
 In N.Y. State call (516) 752-0050

FORDHAM

RADIO SUPPLY CO. INC.
 855 Conklin St.
 Farmingdale, N.Y. 11735

YOUR ONE STOP DISCOUNT CENTER

Master Charge, Bank Americard, Visa, C.O.D.'s accepted.

"We Will Beat Any Advertised Price"



CODs, shipping and insurance extra
 N.Y. State residents add appropriate sales tax

WAMECO

**THE COMPLETE PC BOARD HOUSE
 EVERYTHING FOR THE S-100 BUSS**

INTRODUCTORY SPECIAL

IOB-1 SERIAL/PARALLEL INTERFACE BOARD

- * TWO PARALLEL DATA PORTS PROGRAMMABLE USING AN 8255 WITH SEPARATE HANDSHAKING.
- * ONE SERIAL PORT USING AN 8251 WITH PROVISIONS FOR PARITY, STOP BIT AND CHARACTER LENGTH. BAUD RATES 110 TO 9600 BAUD. OUTPUTS RS232, TTL AND CURRENT LOOP.
- * KANSAS CITY STANDARD CASSETTE INTERFACE, 300 BAUD FOR USE WITH THE SERIAL INTERFACE.
- * STATUS MAY BE POLLING SOFTWARE OR VECTURED INTERRUPTS.
 PCBD\$31.95
 KIT TO BE ANNOUNCED LATER.

FUTURE PRODUCTS: 80 CHARACTER VIDEO BOARD.

Z-80 CPU BOARD WITH RAM, ROM AND PROGRAMMABLE VECTOR INTERRUPTS.

**DEALER INQUIRIES INVITED, UNIVERSITY DISCOUNTS AVAILABLE
 AT YOUR LOCAL DEALER**

MOST PRODUCTS FOR IMMEDIATE SHIPMENT. NO 4-8 WEEK DELAYS REQUIRED FOR OTHERS.



WAMECO INC. 111 GLENN WAY #8, BELMONT, CA 94002 (415) 592-6141

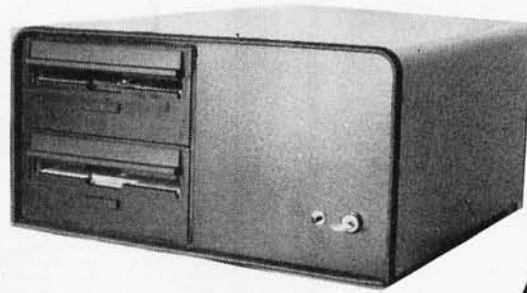
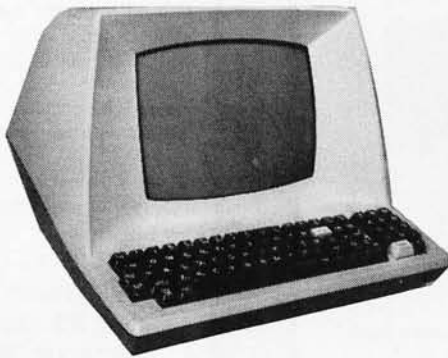

(Printer not pictured)

- A complete computer package, easy to install, easy to maintain
- Practical to operate; designed for the businessman/woman (even for non-computer specialists)
- Upwards expandable (built-in flexibility & updating)
- Desk-top (rack mount available)
- Can use many available software packages
- Expandable for multi-user functions

Specifications:

- Z-80 CPU (4 MHz) with 2 SIO + 3 PIO
- S-100 Compatible
- Two 8" Floppy Disk Drives
- Single/Double Density Disk Controller
- 80 x 24 Terminal with editing capabilities plus second page memory
- 132 Column DOT Matrix printer
- Compiler Business Basic [C Basic 2 – version 2.04]
- Powerful OS-1 Operating System (uses any CP/M or Cromenco program)
- All necessary cabling and documentation
- Osborne software package: general ledger, accounts payable/receivable and payroll

PRAGMATIX – 100™

**Assembled and Tested
\$6995.00**

Options:

- Double sided Disk Drives
- Structured Systems Software
- 220 V/50 Hz available
- Dealer Inquiries Invited
- Quantity pricing available
- Call for exact p&d on options
- Terminal with special function and line insert/delete keys
- 8 channel SIO with real time clock and interrupt control
- Autotype – powerful word processor
- Qume S/5 45 RO Printer with Tractor Feed
- 10 & 20 MBY Removable Hard Disk, DMA Controller & Custom Cabinetry available
- CP/M is a registered trademark of Digital Research

TRS-80 users

Learn FORTH

FORTH is a structured high level language that dramatically cuts program development time. You can expand the FORTH language by defining new operations and data types. FORTH programs are compiled to reduce memory space and speed execution.

tinyFORTH is a complete version of the powerful FORTH language tailored to the TRS-80. The tinyFORTH system includes FORTH, a text editor, an assembler, graphics, and cassette I/O.

Learn FORTH on your own computer. The tinyFORTH user's manual contains hundreds of examples to teach you FORTH in a hands-on style.

tinyFORTH for 16k level II TRS-80:

Cassette and full documentation \$29.95
Documentation only \$ 9.95

All orders are fully guaranteed. And \$1.50 for postage and handling. Order with check, money order, Visa, or Mastercharge.

Write for a FREE booklet describing FORTH.

The Software Farm

Box 2304 Dept. A-20 Reston, VA 22090

Circle 230 on inquiry card.

12" BLACK & WHITE LOW COST VIDEO TERMINAL

\$149.00 LIST

Add \$5 for shipping and handling
Texas residents add 5% sales tax.



One year
limited warranty

• Ideal for home, personal and business computer systems; surveillance monitors • 12" diagonal video monitor • Composite video input • Compatible with many computer systems • Solid-state circuitry for a stable & sharp picture • Video bandwidth—12 MHz ± 3 DB • Input impedance—75 Ohms • Resolution—650 lines Minimum IN Central 80% of CRT; 550 Lines Minimum beyond central 80% of CRT ref EIA RS-375 • Dimensions—11.375" high; 16.250" wide; 11.250" deep (exclude video input connector) • Weight—6.5 KG (14.3 lbs) net

Use Master Charge/Visa or send money order.

Micro Products Unlimited

P.O. Box 1525, Arlington, TX 76010
817/461-8043

Dealer inquiries welcome

Circle 231 on inquiry card.

H9 OWNERS!

Now you too can have graphic capabilities similar to those of the TRS-80 with GRAFIX. No modification to existing circuit boards is required. GRAFIX simply plugs into existing IC sockets.

Comes with complete instructions. Full 6 month warranty.

Kit \$59.95

Assembled and tested \$69.95

Northwest Computer Services, Inc.

8503 N.E. 30th Avenue
Vancouver, WA 98665

Circle 232 on inquiry card.

DISCOUNT PRICES

NORTH STAR
APPLE II
POLYMORPHIC
INTERACT
HAZELTINE
SOROC
CENTRONICS
MICROTEK
INTERTUBE
& Others

Call for Prices
(301) 694-8884

FREDERICK COMPUTER PRODUCTS

Municipal Airport
Frederick, MD. 21701

Circle 233 on inquiry card.

GET Paid for using your Computer

FUN!

Easy

RUSH COUPON FOR
FREE FACTS



GREAT SPARE TIME



Send today to — DAR-B3
3110 Fulton Ave, Sacramento CA 95821

CASH	
NAME	
STREET	
CITY	
STATE	ZIP

Circle 234 on inquiry card.

S-100 4-Channel Serial Interface

Economical interface flexibility for the advanced amateur or small business computerist

- Industry standard LSI UARTS
- 8 reversible status and data ports
- Optically isolated current loop operation
- Independent channel operation — RS-232, 20mA or 60mA current loop
- On-board crystal time base
- One year defect and workmanship warranty

\$249⁹⁵ Plus \$1.50 postage and handling in the U.S.

THETA LABS INC

10911 Dennis Drive / Suite 405 / Dallas, Texas 75229

(214) 241-1090

Dealer Inquiries Welcome

Circle 235 on inquiry card.



6800 DEVELOPMENT PAC II

- 6800 MICRO COMPUTER
- 48K RAM
- EROM PROGRAMMER
- RS-232 INTERFACE
- CASSETTE INTERFACE
- MONITOR DEBUG ROM
- EDITOR/ASSEMBLER
- 4K INDUSTRIAL BASIC
- RACK, BACK PLANE, SUPPLY
- \$1895

WINTEK Corp.

317-742-8428

801 South St., Lafayette, IN 47904

Circle 236 on inquiry card.

* TRS-80 is a registered trademark of Tandy Corp.

TRS-80[™] USERS NEED

SUPERMAP

LEVEL II ROM DOCUMENTATION

Now you can utilize the Level II machine code routines in your assembly language programs. You don't need to waste manhours in deciphering ROM if you have SUPERMAP. Just transfer the comments and explanations in SUPERMAP to your disassembled listing of LEVEL II ROM. SUPERMAP uses more than a thousand lines to document:

Initialization	Command mode encoder
Video Display	BASIC interpreter
Keyboard	"LIST" decoder
Arithmetic I/O	Editor
Cassette I/O	Reserved RAM usage
BASIC commands and functions	

"Persons who are interested in knowing more about the organization of the ROM are encouraged to consult this book for further details."
Hubert S. Howe, Jr., Ph.D., Editor Computronics.

Send check or money order **\$18.95** (214) 642-0441
FULLER SOFTWARE Dealers
630 E. Springdale #B Invited
Grand Prairie, TX 75051 CREDIT CARDS ONLY

Note Add \$1.00 for First class postage if desired.
Foreign orders add \$2.95 for Airmail postage.
Texas residents add \$0.95 for state sales tax.

Circle 237 on inquiry card.

COMPUTER EQUIPMENT & SOFTWARE BARGAINS



EVERY MONTH

BUY, SELL OR TRADE ALL TYPES OF COMPUTER EQUIPMENT AND SOFTWARE (pre-owned and new) among 20,000 readers nationwide in BIG (11x14") pages. Classified ads are only 10¢ per word and are indexed for easy and fast location. Subscription: \$10 a year/12 issues. Bank cards accepted. Money back guarantee.

COMPUTER SHOPPER

P.O. Box F-14
Titusville, FL 32780
(305) 269-3211

Circle 238 on inquiry card.

ComputerCity

When the people
behind the products count!

(Formerly the CPU Shop)™

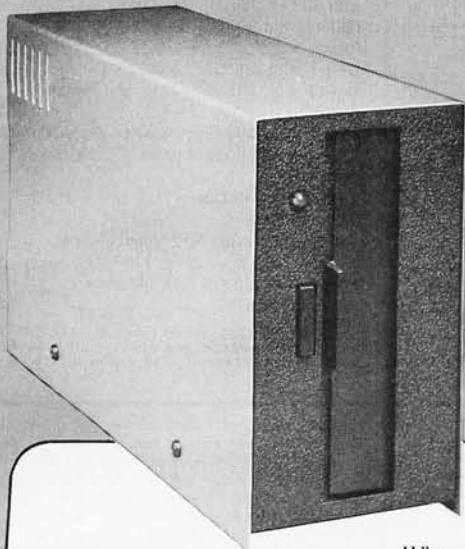

Call for special prices on:

Altos • Apple • ATARI • SUPERBRAIN • SOROC
TRS-80* Model II • NEC • MPI • CENTRONICS • IDS • TI
LEEDEX

New!!!

INSEQ-80—Professional file access (ISAM) for the
TRS-80* microcomputer!

\$4995

ComputerCity Sampler Disk Drives

When you're ready to add disk storage to your TRS-80*, we're here to help. Our CCI-100™ and -200™ drives offer more capacity than Radio Shack 35-Track (85K Bytes) drives. These drives are fully assembled, tested and ready to plug-in the moment you receive them. They can be intermixed with each other and Radio Shack drives on the same cable. 90 day warranty.

CCI-100™ 40 Track (102K Bytes) **\$399.00** CCI-200™ 77 Track (197K Bytes) **\$675.00**

Printers

Letter Quality High Speed Printer

NEC Spinwriter: Includes TRS-80* interface software, quick change print fonts, 55 CPS, bidirectional, high resolution plotting, graphing, proportional spacing and tractor feed assembly. 90 day warranty **\$2979.00**



Also: Centronics, Paper Tiger, HI Plot Digital Plotter

16K Memory Up-grade Kits

Fast and ultrareliable **\$99.00**

DISK OPERATING SYSTEMS

NEWDOS by Apparat† **\$49.95**

NEWDOS "PLUS" by Apparat† **\$110.00**

DISKETTE TRS-80*

BUSINESS SOFTWARE BY SBSG

Free enhancements and upgrades to registered owners for the cost of media and mailing. 30 day free telephone support. User reference on request.

Fully Interactive Accounting Package: General Ledger, Accounts Payable, Accounts Receivable and Payroll. Report generating.

Complete Package (requires 3 or 4 drives) **\$475.00**

Individual Modules (requires 2 or 3 drives) **\$125.00**

Inventory II: (requires 2 or 3 drives) **\$ 99.00**

Mailing List Name & Address II
(requires 2 drives) **\$129.00**

Intelligent Terminal System ST-80 III: **\$150.00**

The Electric Pencil from Michael Shrayner **\$150.00**

File Management System: **\$ 49.00**

Systems Integration Test **\$29.95**

The Source **\$100.00**

ComputerCity™

A division of CPU Industries, Inc.

175 Main Street, Dept. B-3 Charlestown, MA 02129

Hours: 10AM - 6PM (EST) Mon.-Fri. (Sat. till 5)

For detailed information, call 617/242-3350

Massachusetts residents add 5% Sales Tax

™ CCI-100 & -200 are ComputerCity Inc. trademarks

TRS-80 is a trademark of Radio Shack, a Tandy Corporation †Requires Radio Shack TRSDOS

Prices subject to change without notice

TO ORDER CALL TOLL FREE 1-800-343-6522

Massachusetts residents call 617/242-3350

Retail Store Locations:

175 Main Street, Charlestown, MA
K Mart Plaza, Manchester, NH
50 Worcester Road (Rt. 9), Frammingham, MA
165 Angell Street, Providence, RI

Visa and Master Charge accepted

Franchise and dealer inquiries invited



CALIFORNIA COMPUTER SYSTEMS

- 16K RAM BOARD.** Fully buffered addressable in 4K blocks. IEEE computer for bank addressing 2114's. PCBD \$26.95 Kit 450 NSEC\$249.95
- PT-1 PROTO BOARD.** Over 2,600 holes 4" regulators. All S-100 buss functions labeled, gold fingers. PCBD\$25.95
- PT-2 PROTO BOARD.** Similar to PT-1 except set-up to handle solder tail sockets. PCBD\$25.95
- CCS MAIN FRAME.** Kit (S-100)\$349.95
- APPLE EXTENDER.** Kit\$22.95
- APPLE IEEE INSTRUMENTATION INTERFACE KIT 7490.** Kit\$275.00
- ARITHMETIC PROCESSOR FOR APPLE 7811A.** Kit\$350.00
- APPLE ASYNCHRONOUS SERIAL INTERFACE 7710A.** Kit\$89.95
- APPLE SYNCHRONOUS SERIAL INTERFACE 7712A.** Kit\$89.95
- ALL OTHER CCS PRODUCTS AVAILABLE**
- SSM**
- PB-1 2708 & 2716 Programming Board** with provisions for 4K or 8K EPROM. No external supplies require textool sockets. Kit\$129.95
- CB-1A 8080 Processor Board.** 2K of PROM 256 BYTE RAM power on/rest Vector Jump Parallel port with status. Kit\$129.95 PCBD\$30.95
- VB-3 80 x 55 VIDEO BOARD.** Graphic included TBD
- IO-4 Two serial I/O ports** with full handshaking 20/60 ma current loop: Two parallel I/O ports. Kit\$130.00 PCBD\$26.95
- VB-1B 64 x 16 video board,** upper lower case Greek composite and parallel video with software, S-100. Kit\$125.00 PCBD\$26.95
- CB-2 Z80 CPU BOARD.** Kit\$185.95
- AIO APPLE SERIAL/PARALLEL**\$159.95
- ALL OTHER SSM PRODUCTS AVAILABLE**

WMC inc. WAMECO INC.

- FDC-1 FLOPPY CONTROLLER BOARD** will drive shugart, pertek, remic 5" & 8" drives up to 8 drives, on board PROM with power boot up, will operate with CPM™ (not included). PCBD\$42.95
- FPB-1 Front Panel.** IMSA size, hex displays. Byte, or instruction single step. PCBD\$47.50
- MEM-1A 8K x 8** fully buffered, S-100, uses 2102 type rams. PCBD\$25.95
- QM-12 MOTHER BOARD,** 13 slot, terminated, S-100 board only\$34.95
- CPU-1 8080A Processor board** S-100 with 8 level vector interrupt. PCBD\$26.95
- RTC-1 Realtime clock board.** Two independent interrupts. Software programmable. PCBD\$23.95
- EPM-1 1702A 4K Eprom card.** PCBD\$25.95
- EPM-2 2708/2716 16K/32K EPROM CARD.** PCBD\$25.95
- QM-9 MOTHER BOARD.** Short Version of QM-12. 9 Slots. PCBD\$30.95
- MEM-2 16K x 8 Fully Buffered 2114 Board** PCBD\$26.95
- PTB-1 POWER SUPPLY AND TERMINATOR BOARD** PCBD\$25.95
- 8080A\$9.95 2708\$9.49
82122.49 2114 (450 NS) low pwr 5.99
82144.49 2114 (200 NS) low pwr 6.99
82243.49 2102A-4L1.20

MAR. SPECIAL SALE ON PREPAID ORDERS

- (Charge cards not included on this offer)
- IOB-1 SERIAL/PARALLEL INTERFACE BOARD.** Two parallel ports 8255, one serial port 8251, one Kansas City standard cassette. PCBD (Introductory)\$25.95

MIKOS PARTS ASSORTMENT WITH WAMECO AND CYBERCOM PCBDS

- MEM-2** with MIKOS #7 16K ram with L2114 450 NSEC\$249.95
- MEM-2** with MIKOS #13 16K ram with L2114 250 NSEC\$279.95
- MEM-1** with MIKOS #1 450 NSEC 8K RAM\$119.95
- CPU-1** with MIKOS #2 8080A CPU\$ 94.95
- QM-12** with MIKOS #4 13 slot mother board\$ 89.95
- RTC-1** with MIKOS #5 real time clock\$ 54.95
- EMP-1** with MIKOS #10 4K 1702 less EPROMS\$ 49.95
- EPM-2** with MIKOS #11 16-32K EPROMS less EPROMS\$ 59.95
- QM-9** with MIKOS #12 9 slot mother board\$ 79.95
- FPB-1** with MIKOS #14 all parts for front panel\$134.95
- MIKOS PARTS ASSORTMENTS ARE ALL FACTORY MARKED PARTS. KITS INCLUDE ALL PARTS LISTED AS REQUIRED FOR THE COMPLETE KIT LESS PARTS LISTED. ALL SOCKETS INCLUDED.

MIKOS

(415) 592-1800
P. O. Box 424 • San Carlos, California 94070
Please send for IC, Xistor and Computer parts list

VISA or MASTERCHARGE. Send account number, interbank number, expiration date and sign your order. Approx. postage will be added. Check or money order will be sent post paid in U.S. If you are not a regular customer, please use charge, cashier's check or postal money order. Otherwise there will be a two-week delay for checks to clear. Calif. residents add 6% tax. Money back 30-day guarantee. We cannot accept returned IC's that have been soldered to. Prices subject to change without notice. \$10 minimum order. \$1.50 service charge on orders less than \$10.00.

C/MOS (DIODE CLAMPED)

4001	27	4024	75	4069	45	74C08	50
4002	27	4028	72	4071	20	74C03	30
4007	27	4077	45	4072	35	74C151	1.75
4009	45	4028	80	4081	27	74C157	1.75
4010	45	4034	95	4022	95	74C160	1.20
4011	27	4030	35	4016	100	74C161	1.15
4012	27	4035	2.75	4518	1.20	74C163	1.90
4013	40	4035	1.50	4520	1.00	74C165	1.25
4014	1.20	4040	1.50	4520	1.00	74C173	1.30
4015	1.00	4040	1.50	4520	1.00	74C173	1.30
4016	45	4044	85	74C02	27	74C174	1.20
4017	1.05	4045	45	74C08	30	74C175	1.30
4018	90	4046	1.95	74C10	27	74C192	1.20
4019	45	4049	75	74C14	1.20	74C193	1.40
4020	1.10	4052	11.00	74C20	27	74C201	50
4021	1.10	4052	11.00	74C20	27	74C202	50
4022	1.00	4051	1.10	74C73	75	74C914	1.90
4023	22	4066	70	74C24	50	74C24	50
4024	22	4066	70	74C24	50	74C24	50

PRINTED CIRCUIT BOARD

4" x 6" DOUBLE SIDED EPOXY BOARD 1/16" thick \$6.00 ea. 5/\$2.60

EPOXY glass vector board 1/16" thick with 1/10" spacing. \$1.95

MAX 100 Freq. counter. An 8 digit 100 MHz counter AC or DC input. - \$129.00

Continental Specialties #2001 1Hz - 100kHz Function Generator, sine, square & triangle output. - \$159.00.

TRANSISTOR SPECIALS

2N6233-NPN SWITCHING POWER . \$1.95
MRF-8004 a CB RF Transistor NPN . \$.75
2N3772 NPN Si TO-3 . \$1.00
2N4908 PNP Si TO-3 . \$1.00
2N3919 NPN Si TO-3 RF . \$1.50
2N1420 NPN Si TO-5 . 3/\$1.00
2N3767 NPN Si TO-66 . \$.70
2N2222 NPN Si TO-18 . \$51.00
2N3055 NPN Si TO-3 . \$.80
2N3904 NPN Si TO-92 . \$61.00
2N3906 PNP Si TO-92 . 6/\$1.00
2N5296 NPN Si TO-220 . \$.50
2N6109 PNP Si TO-220 . \$.55
2N3638 PNP Si TO-5 . 5/\$1.00
MPSA 13 NPN Si . 4/\$1.00
2N546 PNP GERM TO-3 . \$.95

Full Wave Bridges

PRV	2A	6A	25A
100	80	130	140
200	80	130	220
400	100	165	330
600	130	190	440

DIP SOCKETS

8 PIN 17	24 PIN .35
14 PIN 20	28 PIN .40
16 PIN 22	40 PIN .60
18 PIN 25	

SANKEN AUDIO POWER AMPS

SI 1010 G 10 WATTS \$ 6.75
SI 1020 G 20 WATTS \$12.95
SI 1050 G 50 WATTS \$26.90

TANTALUM CAPACITORS

.22UF 35V 5/\$1.00	6.8UF 35V 4/\$1.00
.47UF 35V 5/\$1.00	10UF 10V \$.25
.68UF 35V 5/\$1.00	22UF 25V \$.40
1UF 35V 5/\$1.00	15UF 35V 3/\$1.00
2.2UF 20V 5/\$1.00	30UF 6V 5/\$1.00
3.3UF 20V 4/\$1.00	100UF 15V \$.70
4.7UF 15V 5/\$1.00	150UF 15V \$.95
	68 UF 15V \$.50

TTL REED RELAY - SPST 5V 20ma \$1.00

1488 REED INTER FACE	\$1.40	4163	5.50
1488 REED INTER FACE	1.20	5260/5268 AC DYN RAM	3.40
2008 TTL STATE SHIF. DR.	1.35	1488 4006L	3.95
2013 CHAMAC GEN. UP.	6.75	82023	1.95
2018 MEX 128 BIT DR.	2.90	82029	1.95
2022 STATIC SHIF. REG.	1.95	82101	2.95
2708 MEX EPROM (4K) bit	3.95	82136	2.95
2708 MEX EPROM (8K) BIT DR.	1.95	82137	2.95
2716 1713 VOLTAGES	24.35	82138	2.95
2716 1713 VOLTAGES	24.35	82139	2.95
2716 1713 VOLTAGES	24.35	82140	2.95
2716 1713 VOLTAGES	24.35	82141	2.95
2716 1713 VOLTAGES	24.35	82142	2.95
2716 1713 VOLTAGES	24.35	82143	2.95
2716 1713 VOLTAGES	24.35	82144	2.95
2716 1713 VOLTAGES	24.35	82145	2.95
2716 1713 VOLTAGES	24.35	82146	2.95
2716 1713 VOLTAGES	24.35	82147	2.95
2716 1713 VOLTAGES	24.35	82148	2.95
2716 1713 VOLTAGES	24.35	82149	2.95
2716 1713 VOLTAGES	24.35	82150	2.95
2716 1713 VOLTAGES	24.35	82151	2.95
2716 1713 VOLTAGES	24.35	82152	2.95
2716 1713 VOLTAGES	24.35	82153	2.95
2716 1713 VOLTAGES	24.35	82154	2.95
2716 1713 VOLTAGES	24.35	82155	2.95
2716 1713 VOLTAGES	24.35	82156	2.95
2716 1713 VOLTAGES	24.35	82157	2.95
2716 1713 VOLTAGES	24.35	82158	2.95
2716 1713 VOLTAGES	24.35	82159	2.95
2716 1713 VOLTAGES	24.35	82160	2.95
2716 1713 VOLTAGES	24.35	82161	2.95
2716 1713 VOLTAGES	24.35	82162	2.95
2716 1713 VOLTAGES	24.35	82163	2.95
2716 1713 VOLTAGES	24.35	82164	2.95
2716 1713 VOLTAGES	24.35	82165	2.95
2716 1713 VOLTAGES	24.35	82166	2.95
2716 1713 VOLTAGES	24.35	82167	2.95
2716 1713 VOLTAGES	24.35	82168	2.95
2716 1713 VOLTAGES	24.35	82169	2.95
2716 1713 VOLTAGES	24.35	82170	2.95
2716 1713 VOLTAGES	24.35	82171	2.95
2716 1713 VOLTAGES	24.35	82172	2.95
2716 1713 VOLTAGES	24.35	82173	2.95
2716 1713 VOLTAGES	24.35	82174	2.95
2716 1713 VOLTAGES	24.35	82175	2.95
2716 1713 VOLTAGES	24.35	82176	2.95
2716 1713 VOLTAGES	24.35	82177	2.95
2716 1713 VOLTAGES	24.35	82178	2.95
2716 1713 VOLTAGES	24.35	82179	2.95
2716 1713 VOLTAGES	24.35	82180	2.95
2716 1713 VOLTAGES	24.35	82181	2.95
2716 1713 VOLTAGES	24.35	82182	2.95
2716 1713 VOLTAGES	24.35	82183	2.95
2716 1713 VOLTAGES	24.35	82184	2.95
2716 1713 VOLTAGES	24.35	82185	2.95
2716 1713 VOLTAGES	24.35	82186	2.95
2716 1713 VOLTAGES	24.35	82187	2.95
2716 1713 VOLTAGES	24.35	82188	2.95
2716 1713 VOLTAGES	24.35	82189	2.95
2716 1713 VOLTAGES	24.35	82190	2.95
2716 1713 VOLTAGES	24.35	82191	2.95
2716 1713 VOLTAGES	24.35	82192	2.95
2716 1713 VOLTAGES	24.35	82193	2.95
2716 1713 VOLTAGES	24.35	82194	2.95
2716 1713 VOLTAGES	24.35	82195	2.95
2716 1713 VOLTAGES	24.35	82196	2.95
2716 1713 VOLTAGES	24.35	82197	2.95
2716 1713 VOLTAGES	24.35	82198	2.95
2716 1713 VOLTAGES	24.35	82199	2.95
2716 1713 VOLTAGES	24.35	82200	2.95
2716 1713 VOLTAGES	24.35	82201	2.95
2716 1713 VOLTAGES	24.35	82202	2.95
2716 1713 VOLTAGES	24.35	82203	2.95
2716 1713 VOLTAGES	24.35	82204	2.95
2716 1713 VOLTAGES	24.35	82205	2.95
2716 1713 VOLTAGES	24.35	82206	2.95
2716 1713 VOLTAGES	24.35	82207	2.95
2716 1713 VOLTAGES	24.35	82208	2.95
2716 1713 VOLTAGES	24.35	82209	2.95
2716 1713 VOLTAGES	24.35	82210	2.95
2716 1713 VOLTAGES	24.35	82211	2.95
2716 1713 VOLTAGES	24.35	82212	2.95
2716 1713 VOLTAGES	24.35	82213	2.95
2716 1713 VOLTAGES	24.35	82214	2.95
2716 1713 VOLTAGES	24.35	82215	2.95
2716 1713 VOLTAGES	24.35	82216	2.95
2716 1713 VOLTAGES	24.35	82217	2.95
2716 1713 VOLTAGES	24.35	82218	2.95
2716 1713 VOLTAGES	24.35	82219	2.95
2716 1713 VOLTAGES	24.35	82220	2.95
2716 1713 VOLTAGES	24.35	82221	2.95
2716 1713 VOLTAGES	24.35	82222	2.95
2716 1713 VOLTAGES	24.35	82223	2.95
2716 1713 VOLTAGES	24.35	82224	2.95
2716 1713 VOLTAGES	24.35	82225	2.95
2716 1713 VOLTAGES	24.35	82226	2.95
2716 1713 VOLTAGES	24.35	82227	2.95
2716 1713 VOLTAGES	24.35	82228	2.95
2716 1713 VOLTAGES	24.35	82229	2.95
2716 1713 VOLTAGES	24.35	82230	2.95
2716 1713 VOLTAGES	24.35	82231	2.95
2716 1713 VOLTAGES	24.35	82232	2.95
2716 1713 VOLTAGES	24.35	82233	2.95
2716 1713 VOLTAGES	24.35	82234	2.95
2716 1713 VOLTAGES	24.35	82235	2.95
2716 1713 VOLTAGES	24.35	82236	2.95
2716 1713 VOLTAGES	24.35	82237	2.95
2716 1713 VOLTAGES	24.35	82238	2.95
2716 1713 VOLTAGES	24.35	82239	2.95
2716 1713 VOLTAGES	24.35	82240	2.95
2716 1713 VOLTAGES	24.35	82241	2.95
2716 1713 VOLTAGES	24.35	82242	2.95
2716 1713 VOLTAGES	24.35	82243	2.95
2716 1713 VOLTAGES	24.35	82244	2.95
2716 1713 VOLTAGES	24.35	82245	2.95
2716 1713 VOLTAGES	24.35	82246	2.95
2716 1713 VOLTAGES	24.35	82247	2.95
2716 1713 VOLTAGES	24.35	82248	2.95
2716 1713 VOLTAGES	24.35	82249	2.95
2716 1713 VOLTAGES	24.35	82250	2.95
2716 1713 VOLTAGES	24.35	82251	2.95
2716 1713 VOLTAGES	24.35	82252	2.95
2716 1713 VOLTAGES	24.35	82253	2.95
2716 1713 VOLTAGES	24.35	82254	2.95
2716 1713 VOLTAGES	24.35	82255	2.95
2716 1713 VOLTAGES	24.35	82256	2.95
2716 1713 VOLTAGES	24.35	82257	2.95
2716 1713 VOLTAGES	24.35	82258	2.95
2716 1713 VOLTAGES	24.35	82259	2.95
2716 1713 VOLTAGES	24.35	82260	2.95
2716 1713 VOLTAGES	24.35	82261	2.95
2716 1713 VOLTAGES	24.35	82262	2.95
2716 1713 VOLTAGES	24.35	82263	2.95
2716 1713 VOLTAGES	24.35	82264	2.95
2716 1713 VOLTAGES	24.35	82265	2.95
2716 1713 VOLTAGES	24.35	82266	2.

DIGITAL RESEARCH COMPUTERS

(214) 494-1505

16K EPROM CARD-S 100 BUSS

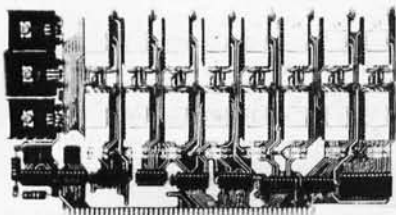

\$59.95
KIT

FIRST TIME OFFERED!
BLANK PC BOARD - \$28

USES 2708's!

Thousands of personal and business systems around the world use this board with complete satisfaction. Puts 16K of software on line at **ALL TIMES!** Kit features a top quality soldermasked and silk-screened PC board and first run parts and sockets. Any number of EPROM locations may be disabled to avoid any memory conflicts. Fully buffered and has WAIT STATE capabilities.

OUR 450 NS 2708'S
ARE \$8.95 EA. WITH
PURCHASE OF KIT

ASSEMBLED
AND FULLY TESTED
ADD \$25

8K LOW POWER RAM KIT-S 100 BUSS SALE

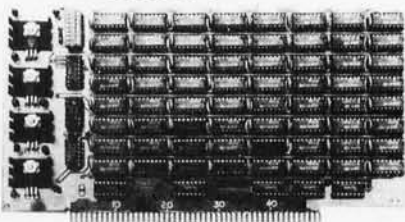

PRICE
CUT!

\$119.50
KIT

21L02
(450 NS RAMS!)

Thousands of computer systems rely on this rugged, work horse, RAM board. Designed for error-free, NO HASSLE, systems use.

Blank PC Board w/Documentation
\$29.95

Low Profile Socket Set...13.50

Support IC's (TTL & Regulators)
\$9.75

Bypass CAP's (Disc & Tantalums)
\$4.50

ASSEMBLED AND FULLY
BURNED IN ADD \$30

ALL ASSEMBLED BOARDS
ARE TESTED AT 4MHZ.

16K STATIC RAM KIT-S 100 BUSS

PRICE CUT!

\$259 KIT

FOR 4MHZ
ADD \$25

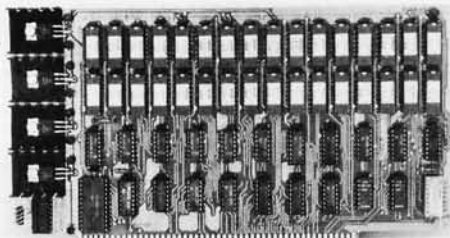

KIT FEATURES:

1. Addressable as four separate 4K Blocks.
2. ON BOARD BANK SELECT circuitry. (Cromemco Standard!). Allows up to 512K on line!
3. Uses 2114 (450NS) 4K Static Rams.
4. ON BOARD SELECTABLE WAIT STATES.
5. Double sided PC Board, with solder mask and silk screened layout. Gold plated contact fingers
6. All address and data lines fully buffered.
7. Kit includes ALL parts and sockets.
8. PHANTOM is jumpered to PIN 67.
9. LOW POWER: under 1.5 amps TYPICAL from the +8 Volt Buss
10. Blank PC Board can be populated as any multiple of 4K.

BLANK PC BOARD W/DATA-\$33

LOW PROFILE SOCKET SET-\$12

SUPPORT IC'S & CAPS-\$19.95

ASSEMBLED & TESTED-ADD \$30

OUR #1 SELLING
RAM BOARD!

16K STATIC RAM SS-50 BUSS

PRICE CUT!

\$249 KIT

FULLY STATIC
AT DYNAMIC
PRICES

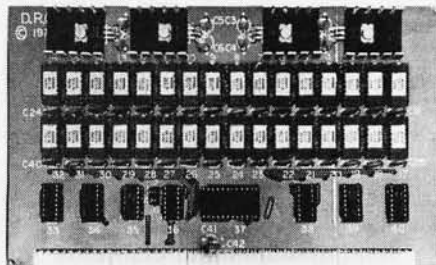

KIT FEATURES:

1. Addressable on 16K Boundaries
2. Uses 2114 Static Ram
3. Runs at Full Speed
4. Double sided PC Board Solder mask and silk screened layout Gold fingers
5. All Parts and Sockets included
6. Low Power Under 1.5 Amps Typical

FOR SWTPC
6800 BUSS!

ASSEMBLED AND
TESTED - \$30

BLANK PC BOARD-\$26

COMPLETE SOCKET SET-\$12

SUPPORT IC'S AND CAPS-\$19.95

PROC. TECH. QUILTS THE MICROPROCESSOR BUSINESS!
FACTORY CLOSE OUT - SPECIAL PURCHASE!
#16KRA

16K S-100 Dynamic Ram Board

~~\$149.95~~ Sold Out

We purchased the remaining inventory of PT's popular 16K Ram Board when they recently closed their plant. Don't miss the boat! These are brand new, fully tested, ASSEMBLED and ready to go. All are sold with our standard 90 day limited warranty!!
Orig. \$429 each! 72 Page Full Manual, Included Free!

Z-80 PROGRAMMING MANUAL

By MOSTEK, or ZILOG. The most detailed explanation ever on the working of the Z-80 CPU CHIPS. At least one full page on each of the 158 Z-80 instructions. A **must** reference manual for any user of the Z-80. 300 pages.

\$12.95

SALE!

LOW POWER - 250NS
2114 RAM SALE!

8 FOR
\$55

4K STATIC RAM'S. MAJOR BRAND, NEW PARTS.
These are the most sought after 2114's, LOW POWER and 250NS FAST.
SPECIAL SALE: \$7.50 ea. or 8 For \$55

Digital Research Computers
(OF TEXAS)

P.O. BOX 401565 • GARLAND, TEXAS 75040 • (214) 494-1505

Perfect for
OEM's

S-100 Z80 CPU CARD

\$159.95

WIRED!
NOT A KIT!

4 MHZ

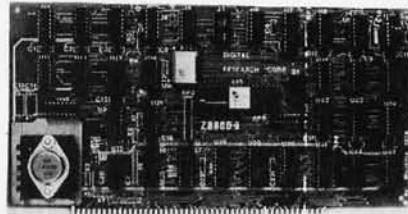

ASSEMBLED AND TESTED! READY TO USE! Over 3 years of design efforts were required to produce a TRUE S-100 Z80 CPU at a genuinely bargain price!

BRAND NEW!

FEATURES:

- * 2 or 4 MHZ Operation
- * Generates MWRITE, so no front panel required
- * Jump on reset capability
- * 8080 Signals emulated for S-100 compatibility
- * Top Quality PCB Silk Screened Solder Masked Gold Plated Contact Fingers

NEW! G.I. COMPUTER SOUND CHIP

AY3-8910. As featured in July, 1979 BYTE! A fantastically powerful Sound & Music Generator. Perfect for use with any 8 Bit Microprocessor. Contains: 3 Tone Channels, Noise Generator, 3 Channels of Amplitude Control, 16 Bit Envelope Period Control, 2-8 But Parallel /O. 3 D to A Converters, plus much more! All in one 40 Pin DIP. Super easy to interface to the S-100 or other busses.

SPECIAL OFFER: \$14.95 each Add \$3 for 64 page Data Manual

TERMS: Add \$1.00 postage, we pay balance. Orders under \$15 add 75c handling. No C.O.D. We accept Visa and MasterCard. Tex. Res. add 5% Tax. Foreign orders (except Canada) add 20% P & H. 90 Day Money Back Guarantee on all items.



FREE! Up to \$170 in merchandise with purchase of one of following PET-CBM items !!!

Axiom EX-801 PET Printer (with graphics)	\$ 475.00
Axiom EX-820 PET Plotter	\$ 749.00
Anderson Jacobson 841 Selectric	\$1015.00
Leedex Video 100 12" Monitor	\$ 119.00
Heath WH19 Terminal (factory asm.)	\$ 770.00
Heath WH14 Printer (factory asm.)	\$ 735.00
IEEE-RS232 Printer Adaptor for PET	\$ 88.00

BETSII PET to S-100 Interface	\$ 119.00
PET Connectors-Parallel or IEEE	\$ 1.95
Cassette Port	\$ 1.45
Hands on Basic with a PET	\$ 9.45
Programming the 6502 (Zaks)	\$ 9.45
6502 Applications Book (Zaks)	\$ 10.45
6500 Manuals (MOS Technology)	\$ 6.50
Programming a Microcomputer: 6502	\$ 8.45
6502 Assembly Language (Osborne) NEW!	\$ 8.10

PET SPECIALS

PET 16N 16K full size graphics keyboard	\$ 995	\$130
PET 16B 16K full size business keyboard	\$ 995	\$130
PET 32N 32K full size graphics keyboard	\$1295	\$170
PET 32B 32K full size business keyboard	\$1295	\$170
PET 8N 8K full size graphics keyboard	\$ 795	\$100
PET 2040 DUAL DISK DRIVE-343,000 bytes	\$1295	\$170
PET 2022 Tractor Feed Printer	\$ 795	\$100
PET 2023 Pressure Feed Printer	\$ 695	\$ 70
PET C2N External Cassette Deck	\$ 95	\$ 12
Used 8K PETs (limited quantities)	\$ 495	

***FREE**

*Amount of Free Merchandise with Purchase of PET-CBM Item.

KIM-1 \$159 (add \$30 for power supply) SYM-1	\$209
BAS-1 Microsoft ROM Basic for SYM	\$ 85
Memory Plus (KIM, SYM, AIM)	\$195
SYM Assembler in ROM	\$ 85
SEA-16 New 16K Static RAM	\$325
Seawell Motherboard - 4K RAM Space	\$139
KTM-2/80 Synertek Video Board	\$349
S-100 16K Static RAM Kit SALE	\$219
TIS PET Workbooks - set of 6	\$ 21.50
Dust Cover for PET	\$ 8.90

All Book and Software Prices are Discounted

PET Personal Computer Guide (Osborne)	\$ 12.75
PET and the IEEE-488 Bus (Osborne)	\$ 12.75
6502 Software Cookbook (Scelbi)	\$ 9.45
Cassettes (all tapes guaranteed) AGFA PE611 Premium quality, high out put low noise in 5 screw housing with labels:	
C-10 10/5.65 50/25.00 100/48.00	
C-30 10/6.90 50/30.00 100/57.00	

2716 EPROM (5 volt)	\$ 29.00	
6550 RAM (for 8K PET)	\$ 12.70	
6502 \$9.75	6522 \$9.00	6520 \$5.50
2114 L 450 ns \$5.35	24@ \$4.95	100 @ \$4.45

ATARI - INTRODUCTORY SPECIAL

ATARI 400, Atari 800 and all Atari Modules 20% OFF.

Programmers Toolkit - PET ROM Utilities	\$ 44.90
Sargon II (TRS-80 or Apple) NEW!	\$ 24.90
Microchess for PET (Peter Jennings)	\$ 17.90
Visible Music Monitor (4 Voice) for PET	\$ 29.90
KL-4M 4 Voice Music Board (PET)	\$ 34.90
CmC Word Processor (8K \$25) (16K \$34)	
Adventures by Scott Adams	15% Off



SALE

3M "Scotch" 8" Disks	10/\$31.00
3M "Scotch" 5" diskettes	10/\$31.50
Verbatim 5" diskettes	10/\$26.50
Diskette Storage Pages	10/\$ 3.95
Disk Storage Boxes 8" \$2.85 5 1/4" \$1.95	
(Write for quantity prices)	



MINIMAX by COMPU/THINK

MINIMAX I (8 Megabyte Disks) **\$4495**
MINIMAX II (2.4 Megabyte Disks) **\$5995**

SPECIAL - MINIMAX prices include Compu/Think PAGEMATE Database and Report Writer at no charge.

The most advanced complete microcomputer system available. Includes CPU, 12" CRT, Full Keyboard, 2 Quad-Density Disk Drives, 2 Megahertz 6502 Hybrid Processor (double speed), 108 K System Memory, High Resolution (512 x 240) Graphics, Programmable Character Fonts, Microsoft Extended BASIC, DOS with Random Access I/O, Full Complement of I/O Ports, Monitor with Debug, Trace, and Tiny Assembler, Fifth (PL/M and Forth combination) Interpreter, Complete editing and entry with split screen capability, 64 Microprogrammable Opcodes, Business software (with Database) available.

115 E. Stump Road
Montgomeryville, PA 18936

(215) 699-8386
699-5826

A B Computers

WRITE FOR COMPLETE CATALOG

Add \$1.00 per order for shipping.
We pay balance of UPS surface charges on all prepaid orders.

UP TO 25% OFF

YOUR OWN TRS-80 SYSTEM AT TREMENDOUS SAVINGS

Visit our new Store at 20th & Walnut, Phila., PA



ITEM	REG. PRICE	OUR PRICE
Level II-4k	\$619.00	\$575.70
Level II-16k	\$849.00	\$789.60
Expansion Interface	\$299.00	\$278.00
Mini Disk Drive	\$ 495.00	\$ 385.00
Centronics 779 Printer	\$1599.00	\$1175.00
Centronics 101 Printer	\$1595.00	\$1400.00
Anadex DP-8000 Printer	\$1295.00	\$ 995.00
Memory Kit (16K) FREE INSTALLATION	\$ 149.00	\$ 98.00
Verbatim Diskettes ea	\$ 5.95	\$ 4.95
3	\$ 17.89	\$ 12.00
10	\$ 59.00	\$ 37.00
C-10 Cassettes	\$ 4.95	\$ 4.50
25	\$ 24.75	\$ 18.75
Paper (9 1/2" x 11" fanfold, 3500 sheets)	\$ 35.00	\$ 29.95

SALE

Centronics 730 \$850.00

Same as Line Printer II

TRS-80 MODEL II	\$3626.00
• 64K RAM	
• 1/2 MEG DISK	
ADDITIONAL DISK DRIVE (1ST)	\$1069.50
ADDITIONAL DISK DRIVE (2ND + 3RD)	\$ 558.00
VR Data's 1st Drive	\$ 899.00

BUSINESS SOFTWARE

	Model II	Model I
Payroll	\$199.00	\$99.00
General LEDGER (inc. AP, AR, etc.)	\$199.00	\$149.00
DATA BASE MANAGEMENT SYSTEM	\$249.00	\$149.00
Documentation only (each Package)	\$5.00	

GENERAL SOFTWARE

NEW DOS+	35 tk.	40 tk.
	\$99.00	\$110.00
Electric Pencil	Tape	Disk
	\$99.00	\$150.00
Upper/Lower Case Conversion	Tape \$19.95	Disk \$24.95
Diagnostics	Tape/Disk \$34.55	
Household Inventory		Disk \$19.95
Loan Amortization Schedule		\$19.95

MARCH SPECIAL

(Good until 3/31/80)

MINI-DISK DRIVES \$350.00

-NEW-

5 1/4" Disk Head Cleaner Kit **\$14.95**

NOW OPEN

VR DATA'S Computer Repair Center

There are new developments every day - write or call for the latest information.

VR Data
777 Henderson Boulevard N-6
Folcroft Industrial Park
Folcroft PA 19032
(215) 461-5300



TOLL FREE 1-(800) 345-8102 *Orders only!

FOREIGN and DOMESTIC DISTRIBUTORSHIPS AVAILABLE . . .



Radio Hut

201 LOCHWOOD MALL • DALLAS, TEXAS 75218
ORDER BY PHONE—214-324-5509

PLEASE WRITE FOR CATALOG
PRICES SUBJECT TO CHANGE
WITHOUT NOTICE

ORDERING INFORMATION & TERMS: Orders under \$15.00 add 75¢ handling. No C.O.D. We accept Visa, MasterCard, and American Express cards. Tex. Res. add 5% tax. Foreign orders (except Canada) add 20% P&H. 90 Day Money Back Guarantee on all items. Add 5% P&H, maximum \$5.00.
ORDER BY PHONE — (214) 324-5509

The EXPANDORAM is available in versions from 16K up to 64K, so for a minimum investment you can have a memory system that will grow with your needs. This is a dynamic memory with the invisible on-board refresh, and IT WORKS!

- Bank Selectable
- Phantom
- Power 8VDC, +16VDC, 5 Watts
- Lowest Cost Per Bit
- Uses Major Brand 16K RAMS
- PC Board is doubled solder masked and has silk-screened parts layout
- Extensive documentation clearly written

SD EXPANDORAM

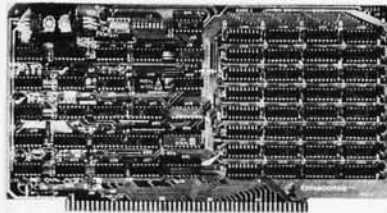

- Complete kit includes all Sockets for 64K
- Memory access time: 375ns, Cycle time: 500ns.
- No wait states required
- 16K boundaries and Protection, via Dip Switches
- Designed to work with Z-80, 8080, 8085 CPU's

EXPANDORAM 64K Kit (16K Ram)

16K	\$239.95
32K	309.95
48K	379.95
64K	449.95

SD'S PROM 100 PROM Programmer Board

The PROM-100 Programmer is a development tool for S-100 Bus computer systems. The Zero Insertion Force Programming Socket extends above the card cage height for easy access to PROM devices. Software verifies PROM erasure, verifies program loading and provides for reading of object file from Disk or PROM and programming into PROM/EPROM. Features include: On-board generated 25vdc Programming pulse, TTL compatible, maximum programming time for 16,389 bits is 100 seconds. Programs: 2708, Intel 2758, 2716, 2732 and TI 2516. DIP Selectable EPROM type.

PROM-100 Board Kit **\$149.95**

SD'S SBC-200 SINGLE BOARD COMPUTER Kit \$289.95

S-100 Bus compatible and based on the powerful Z80 microprocessor, the SBC-200 meets the needs of a Z-80 CPU board with many additional features. Ideal for Industrial and control applications. All of the same features that have made the SBC-100 famous, PLUS 4MHz OPERATION. • S-100 Bus Compatible • Z80 Central Processing Unit • 1024 Bytes of Random Access Memory • 8K Bytes of PROM using 2716 • Serial Input/Output Port (with Asynchronous and Synchronous Operation) • Parallel Input and Output Ports • Four Channel Counter/Timer (Z80-CTC) • Software Programmable Baud Rate Generator • No-Front Panel Required for Operation • 4 MHz Operation.

SD'S VERSAFLOPPY II

• IBM 3740 Compatible Soft Sectors Format for Single Density Drives • Operates with Single and Dual Sided Drives, Single or Double Density Drives and 5" & 8" Drives — in any combination of four simultaneously • Drive Select and Side Select Circuitry • S-100 Bus Compatible • Vectored Interrupt Operation Optional • Phase Locked Loop Data Recovery Circuit • Operates with Z80 CPU's • Uses FD1791-1 Controller Chip • The Versafloppy II incorporates all the possible features of a flexible disk drive controller into one board. Capable of handling four drives simultaneously, combinations of any variety are possible, such as 5" single sided, 8" dual density dual sided, 5" dual density single sided. Most popular drives are controlled directly with the Versafloppy II. The operating system for the Versafloppy II is the extremely powerful SDOS available for SD Systems. Diagnostic and control software available to complete your disk system.

KIT \$335.95



SD'S VDB-8024 VIDEO DISPLAY BOARD

The VDB-8024 features its own on-board Z80

microprocessor. This gives the capability of using software (included in ROM) to control functions and enhancements without interference with the computer's CPU. Included in the special features: 80 characters by 24 lines display, keyboard power and interface, composite and separate video output, 2K on-board RAM, a total of 256 available characters, full cursor control, forward and reverse scrolling, underlining, field reverse, field protect enhancements, programmable characters.

KIT \$329.95 A&T \$389.95

SD'S "VERSAFLOPPY I" KIT

FEATURES: IBM 3740 soft sectored compatible, S-100 BNS Compatible for Z-80 or 8080. Controls up to 4 drives (single or double sided). Directly controls the following drives: Sugart SA400/450 Mini Floppy • Shugart SA800/850 Standard Floppy • PERSCI 70 and 277 • MFE 700/750 • CDC 9404/9406

\$189.95



SD'S SBC-100 SINGLE BOARD COMPUTER

The SBC-100 provides a complete micro-computer

on a single board! The Z80 microprocessor is used as the heart of the SBC-100. The SBC-100 meets all the requirements of a Z80 CPU board with the added features of I/O ports, counter/timer channels, on board RAM, provisions for PROM/ROM and a software programmable baud rate generator. S-100 Bus compatible, the SBC-100 features are: 8K bytes of available PROM, 1024 bytes on-board RAM, Serial I/O with both synchronous and asynchronous operation, Parallel I/O ports, Operational Vectored Interrupts, and Four Counter/Timer Channels. SD Monitor available for RS-232 and Video Terminals. Disk based system software also available.

SBC-100 KIT \$249.95

TARBELL FLOPPY DISK INTERFACE

Compatible with Z80 & 8080. S-100 Bus. Uses CPM operating system. Plugs directly into your IMSAI or ALTAIR • Fastest transfer rate
KIT \$190.00 Assembled & Tested \$260.00

TARBELL CASSETTE INTERFACE

Plugs directly into your IMSAI or ALTAIR • Fastest transfer rate • Extremely reliable • Phase encoded • 4 extra status & control lines
KIT \$99.95

Z80 STARTER KIT

Kit: \$279.95 Assembled & Tested \$349.95
SD System's Z80 Starter Kit enables the novice to build a complete microcomputer on a single board. Featuring the powerful Z80 microprocessor, the Z80 Starter Kit features:

- Keyboard and Display
- Audio Interface
- PROM Programmer
- Expansion and Wire Wrap Area
- On Board RAM • 4 Channel Counter/Timer
- Z-BUG Monitor in PROM • I/O Ports.

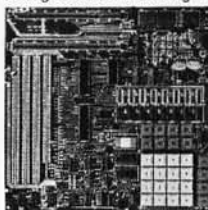

SSM CB2 Z-80 CPU Board Kit \$186.00

Operates at 2 MHz or 4 MHz by DIP switch selection and includes two sockets for 2716 or 2732 EPROMs or TMS 4016 2K RAMs. Jumper options generate the new IEEE S-100 signals.

SSM VB3 80 Character Video Board Kit \$299.95

• 80 char. per line, up to 51 lines • Graphics up to 160 x 204 matrix • Up to 256 user defined symbols (optional EPROM) • Composite video

PB1 2708/2716 Programmer & 4K/8K EPROM Board Kit \$124.00

• S-100 bus • 2 separate programming sockets for 2708 or 2716 (5V) EPROMs • Programming voltage generated on board — no need for an external power supply • Software control of 2708/2716 programming selection • LED indicator for programming mode and an on-off switch for programming voltage • 4 sockets for 4K of 2708 or 8K of 2716 EPROMs • Unused EPROM sockets do not enable data bus drive so the board is never committed to the full 4K or 8K of memory • Jumper selectable wait states (0-4) for fast or slow EPROMS



NOVATION CAT ACOUSTIC COUPLER/MODEM \$189.00

Let your computer communicate with other computers. Bell Systems 103 compatible 300 baud, answer or originate.

SYM-1 Reg. \$269.00 NOW \$219.00

- KIM-1 Compatible
- 4K ROM Monitor
- 1K Bytes 2114 RAM
- 65K Memory Expansion
- User EPROM 2716

IO4 2 Parallel/2 Serial I/O Board Kit \$126.00

• S-100 bus • 2 serial I/O ports (2 in & 2 out) • Independent baud-rate selection from 55 to 9600 baud • Regulated +5V, +12V & -12V outputs provided on both serial headers • 2 latched parallel I/O ports (2 in & 2 out) • Independent DIP switches for setting address • Interrupt capability provided for on serial and parallel I/O ports • +8V @ 0.95A, +16V @ 0.6A, & -16V @ 80mA typical SSM

VB18 VIDEO BOARD KIT \$124.00

• S-100 bus • 64 or 32 characters per line (DIP switch selectable), 16 lines • Graphics 128x48 matrix • Upper case, lower case, Greek characters, symbols and numbers • 7x9 dot character matrix • Black-on-white or white-on-black • Timing 60Hz vertical rate, 16.2KHz horizontal rate, Crystal 12.44MHz • Parallel and composite video output (US TV signals), separate video, horizontal and vertical sync SSM

- S-100 Bus Compatible
- Up to 4Mhz Operation
- Expandable Memory from 16K to 256K
- DIP Switch Selectable Boundaries
- Uses 16K (4116) or 64K (4164) Memory Devices
- Page Mode Operation Allows up to 8 Memory Boards on Bus
- Operates with Z80 CPU's
- Phantom Output Disable
- Invisible Refresh (Synchronized with Wait States)

SD'S EXPANDORAM II The Random Access Memory

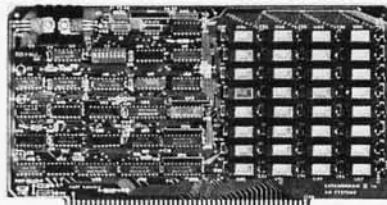

SD Systems' ExpandoRAM II is a dynamic RAM board with capacities from 16K bytes (4116) to 256K bytes (4164). It operates on the industry S-100 Bus. The design allows 8 boards to operate from the same S-100 Bus. The ExpandoRAM II is compatible with most S-100 CPU's based on the Z80 microprocessor.

EXPANDORAM II KIT

16K	\$295.95
32K	369.95
48K	444.95
64K	519.95

MICRO MART

16K UPGRADE KIT FOR TRS-80, APPLE, PET, SORCERER \$70
Mostek 4215-3 200ns 16K x 1 RAMS

MICROPOLIS 8" HARD DISK DRIVE with Power, S-100 controller
9 Megabyte \$3995
27 Megabyte \$4495
45 Megabyte \$4995

APPLE II PLUS 16K \$995.00

DISCOUNTS on EXIDY SORCERER, PET, most other systems, peripherals, and software.

**MICROCOMPUTERS,
PERIPHERALS AND SOFTWARE**

1015 NAVARRO SAN ANTONIO, TEXAS 78205
512/222 1427

Circle 247 on inquiry card.

NORTH STAR PROGRAMS

- * TIME SERIES SYSTEM \$125.00
- * PRETTY PRINTER \$25.00
- * CROSS REFERENCE \$25.00
- * N.S. TO CBASIC \$120.00
- * UNIVERSAL DISK DUMP \$20.00
Dumps Basic, Pascal & CPM files & directories.
- * DISK REPAIR \$20.00
Find & repair bad records.
- * UNIVERSAL MENU \$10.00
- * DIRECTORY UTILITIES \$20.00

POTTERS PROGRAMS

22444 LAKELAND
ST. CLAIR SHORES, MI 48081
(313) 573-8000

Circle 248 on inquiry card.

OHIO SCIENTIFIC SYSTEMS

DISCOUNTED

CALL FOR PRICES

**FARAGHER &
ASSOCIATES**

**7635 BLUEMOUND
MILWAUKEE, WI 53213
(414) 258-2588**

Circle 249 on inquiry card.

ATTENTION

**ENGINEERS, MICRO MANUFACTURERS,
BUSINESSMEN, HOBBYIST**

- (1) A Command List for Graphic Hires Moves & Plots for your Apple. Much easier than manual shows. For drawing and saving graphic shapes in Hex. List only - \$4.00, List & Example Applesoft Program - \$12.96/Disk.
- (2) SHS-2010 Humidity Sensor. Analog 0 - +5 vdc Output. 0 - 100% R.H. Presently being used by many Micro Manufacturers and users for accurate environment control.
- (3) Temperature Sensors; (Thermistors). -30°F to +230°F 10 K ohms at 77°F. Beads, Probes, Water.
- (4) Sunkeeper Energy Management and Data Acquisition Systems. (PROGRAMMABLE). Turn-key or components. Not for residential use. State of the Art.

Reader Service card for
Command List inquiries Only.



EMS

Please write or phone
on all other inquiries.

**B. & W. Energy Management
Systems Inc.**
P.O. Box 1054
Youngstown, Ohio 44501
(216) 747-4212

Circle 250 on inquiry card.

DISCOUNT-9

**-business system-
-software development system-
in turnkey configuration**

FEATURING

- CPU - Cromemco System III
- 1 MB disk memory (2 drives)
- 64kb RAM
- PRINTER - TI 810
- 150 CPS
- full ASCII, includes all options
- CRT - SOROC IQ 120
19,200 CPS
- full ASCII, includes many options
- SOFTWARE
- Fortran IV, COBOL, BASIC
- Word Processing System
- Disk Operating System
at an unbeatable price — \$8900
Other Cromemco components at 21% off list.

We also contract special-purpose
business applications systems.

COMPUTER AND CONTROL AFFILIATES

14 S. Oak St.
Hinsdale, IL 60521
(312) 654-1677

Circle 251 on inquiry card.

CROMEMCO SYSTEMS

- ACCOUNTS RECEIVABLE \$99**
Sales & Cash Receipts Ledgers by Month and/or Year
Aged Trial Balances
Customer Statements & Activity for Credit Management
- ACCOUNTS PAYABLE \$99**
Purchases & Cash Receipts Ledgers by Month and/or Year
Prints Checks, Vouchers & Stubs
Aged Trial Balances
Handles Discounts, Partial Payments, Credits Etc.
- INVENTORY CONTROL (for Manufacturers & Retailers) \$99**
1100 items per 8" disk side
Parts explosions for finished goods & subassemblies
Pull Sheets & Parts requirements forecasting
Economic Order Quantities
- PAYROLL SYSTEM \$99**
300 Employees per 8" disk side
Federal, State & City taxes
Quarterly & Yearly Reports (incl. W-2s)
Weekly, Biweekly, or Monthly Payroll Registers
Prints Employees Checks & Vouchers
Double linked list files for FAST access & update
All programs used over 1 1/2 years by several large Corporations
Hardware required: 48 K RAM, dual floppy disks, 132 col. printer
Written in CROMEMCO 16K Extended Basic (runs under CPM with Expand)

FEITH SOFTWARE
Cedarbrook A-1103
Wyncote, Pa. 19095
(215) 887-9780

Circle 252 on inquiry card.

A METARESEARCH INNOVATION!

**FM-2 CRYSTAL-LOCK ORIGINATE MODEM
ADJUSTMENT FREE - AT LOW COST**



This acoustic modem uses a new type of crystal-lock circuitry. Even in kit form, no calibration or adjustments are required.

- RS232C compatible input and output
- 300bps operation
- Half/full duplex switch
- Crystal controlled transmit & receive circuitry
- Safety AC plug, power jack and transformer

Assembled and tested modem.....\$140.00
Complete kit.....\$105.00
Assembly manual only
(refundable with purchase).....\$12.00
Postpaid in U.S.A.

metaresearch
1100 SE WOODWARD AVE.
PORTLAND, OREGON 97202
(503) 232-1712

Circle 253 on inquiry card.

DISCOUNT COUPON WORTH \$25

When applied toward purchase of BIZCOMP 1031 Intelligent Modem. Offer expires June 30, 1980. Coupon redeemable only on factory purchase.

Dear BIZCOMP:

Please apply this \$25 discount toward the regular purchase price (\$495) of the BIZCOMP 1031 Intelligent Modem.™ (See AD elsewhere in this issue) Ship BIZCOMP 1031 Intelligent Modems @ \$470 ea. (includes Power Module, 7 ft. Modular Extension Cord, and Reference Manual)

Calif. orders add 6% s/s tx _____

TOT _____

Name _____

Address _____ Tel. _____

City/State/Zip _____

Send Money Order or Cashier's Check; allow extra time for personal checks.

BIZCOMP

P.O. Box 7498
Mento Park, California 94025
415/854-5434

Patent Pending

Circle 107 on inquiry card.

Power Supplies @ 5 volts SURPLUS UNITS IN LIKE NEW CONDITION

INPUT: 115 vac 43-63 Hz
OUTPUT: 5 vdc 0.25 amps
REGULATION: 0.1% ± 5 mV
NL. FL. ± 0.1% ± 5mV for 10%
input change
RIPPLE: 2mV RMS max. ± 20 mV
P-P max.
STABILITY: Typically 10 mV for eight hour period



REMOTE SENSING, REMOTE VOLTAGE ADJUSTMENT, OVERLOAD PROTECTION and OVERVOLTAGE PROTECTION
ALSO AVAILABLE IN 12 VDC - 13 AMPS \$79.00 per unit

TANTALUM CAPS 22/44 EDGEBOARD CONNECTOR

• 1 MFD 35 VDC 20%
LARGE QUANTITIES AVAILABLE

5 for \$1.00
Large Quantities Available

\$1.35 each 10 for \$12.50

1 1/2 AMP FULL WAVE BRIDGE RECTIFIER

400 PIV each 2 for \$1.00

TO 3 HOUSE MARKED DARLINGTON TRANSISTOR

\$1.50 each 16 Amps 80 Volts 150 Watts Similar to M4030 PNP Similar to M4023 NPN Specify NPN or PNP

\$1.50 each 10 for \$12.50

C-H D.P.D.T. PRINTED CIRCUIT MINI TOGGLE

+6 amps 125 vac -on -on 10 for \$12.50

ALL ELECTRONICS CORP.

905 S. Vermont Ave. • Los Angeles, Calif. 90006

DEPT. BY-1 (213) 380-8000

TERMS

• Quantities Limited

• Min. Order \$10.00

• Add \$1.50 Shipping USA

• Calif. Res. Add 6% Prompt Shipping

SEND FOR OUR FREE CATALOG

Circle 255 on inquiry card.

Now get OHIO SCIENTIFIC personal computer products with guaranteed, quick, mail order delivery.



ONLY \$279

Ohio Scientific Superboard II

The first complete computer system on a board. Includes keyboard, video display and audio cassette interface. 8K BASIC-in-ROM; 4K RAM. Requires power supply +5V at 3 Amp.

"We heartily recommend Superboard II for the beginner who wants to get into microcomputers with a minimum cost. A real computer with full expandability."

POPULAR ELECTRONICS, MARCH, 1979

"The Superboard II is an excellent choice for the personal computer enthusiast on a budget."

BYTE, MAY, 1979

Ohio Scientific C1P Series.



The Challenger 1P. The best bargain in personal computer anywhere! 8K BASIC-in-ROM. 4K RAM. Cassette based with 53-key keyboard. B&W video display, 30 rows x 30 columns. Upper and lower case. **\$349.** C1P with 8K RAM \$399.

Ohio Scientific C1P MF. Mini-floppy version of the C1P. 8K BASIC-in-ROM, 12K RAM. Fully expandable. **\$995.** C1P MF with 20K RAM and OS-65D software \$1198.

SOFTWARE

Cassettes

MDMS Personal Calendar/Address Book	\$29.00	Home Control II	\$29.00
Function Grapher	\$ 6.00	DAC I Music Generation	\$39.00
Address Book	\$ 8.00	Baseball I & II, Golf, Bowling, Hockey	\$39.00
Programmable Calculator	\$12.00	Poker, Black Jack, Spades, Hearts, more	\$29.00
Savings Account	\$ 6.00	Tiger Tank, Space Attack, Etch-A-Sketch, more	\$29.00
Baseball I	\$ 6.00	Star Wars, Zulu 9, High Noon, more	\$29.00
Battleship	\$ 6.00		
Bowling	\$ 6.00		
Destroyer	\$ 6.00		
Space War	\$ 6.00		
Star Trek	\$ 6.00		
Tiger Tank	\$12.00		

Disks

MDMS Education System	\$29.00	MDMS Aux File Systems	\$29.00
MDMS Checking and Savings Account	\$29.00		

When ordering, specify Challenger 1P, 4P or 8P

Many, many more software systems are available to you. See our catalog for complete listings.

Accessories

AC-3P 12" B/W monitor, TV	\$ 125
AC-15P 12" Color monitor	\$ 450
AC-16P 2-8 Axis Joysticks with cable	\$ 39
AC-11P Answer/Originate 300 baud modem with cable	\$ 199
AC-17P Home Security Starter Set. 1 fire detector, 2 window alarms, 1 door unit.	\$ 249
AC-18P 8 1/2" aluminumized paper printer. Upper/lower case.	\$ 695
AC-9TP Centronics 799 110cps tractor feed, business printer with interface	\$ 1250
AC-12P AC-Remote starter set. Console. 2 lamp modules, 2 appliance modules, OS 65D home control operating system	\$ 175
Disk Drives	
CD 3P Single 5" mini floppy	\$ 499
CD 2P Dual 8" Disk with interface and OS-65D DOS	\$ 1599
Power Supplies	
PS 1. 5-volt @ 3 amps regulated. For use with Superboard II	\$ 29
Boards (Assembled and tested)	
CM 9P. 24K Static.	\$ 399
610. 8K Static. Expandable to 24K and dual mini-floppy controller.	\$ 298
CA-14A. Votrax® voice synthesizer.	\$ 399
CA-15 Universal Telephone Interface, rotary or touch tone	\$ 499
CA-15V UTI with Votrax®	\$ 799
CM-6 48K Dynamic memory board.	\$ 499
4KP. 4K static RAM kit	\$ 69
CA12. 96 line parallel I/O	\$ 175
Books:	
How to Program Microcomputers, By William Barden	\$ 8.95
Basic and Personal Computer By Dwyer & Critchfield	\$12.95
Howard Sams C1P Service Manual	\$ 7.95
Howard Sams C4P Service Manual	\$15.95

Freight Policies

All orders of \$100 or more are shipped freight prepaid. Orders of less than \$100 please add \$4.00 to cover shipping costs. Ohio Residents add 5.5% Sales Tax.

Guaranteed Shipment: Cleveland Consumer Computers & Components guarantees shipment of computer systems within 48 hours upon receipt of your order. **Our failure to ship within 48 hours entitles you to \$35 of software, FREE.**

Ohio Scientific C4P Series.



The Challenger 4P. A 4-slot computer with one open slot. Highly sophisticated 16 color video display. 32 rows x 64 columns, upper and lower case. 8K BASIC-in-ROM 8K RAM. 200-20KHz programmable tone generator. AC remote interface. Expandable to 32K RAM and two mini-floppy drives. **\$698.**

The Challenger 4P MF. Mini Floppy version of the 4P. Two to three times faster than competitors. More I/O built-in than any other in its class. 24K RAM. Real time clock. Modem interface. Printer interface. Foreground/Background operation and much, much more. **\$1695.**

Ohio Scientific 8P Series.



Challenger 8P. Ohio Scientific's mainframe-class. Personal computer. 8 slots with 6 open. Cassette based with 8K BASIC-in-ROM. 8K static RAM, expandable to 32K RAM, and dual 8-inch floppy disk drive. **\$895.**

Challenger 8P DF. A top of the line personal and small business computer. 32K RAM, expandable to 48K. Features dual 8" floppy disk drives. Audio output 200 20KHz. DAC for voice generation. Keypad interfaces. Joystick (2) interfaces. AC Remote. Real Time Clock. Printer & Modem interfaces. And more. **\$2597.**

To Order:

Or to get our free catalog
CALL 1-800-321-5805 TOLL FREE.
Charge your order to your
VISA or MASTER CHARGE ACCOUNT
Ohio Residents Call: (216) 464-8047.
Or write, including your check or money order, to the address listed below.



Hours:

Call Monday thru Friday
8:00 AM to 5:00 PM E.S.T.



**CLEVELAND CONSUMER
COMPUTERS & COMPONENTS**
P.O. Box 46431
Cleveland, Ohio 44146

**TO ORDER: CALL
1-800-321-5805
TOLL FREE**

HOBBYWORLD[®] ELECTRONICS

America's Largest Mail-Order Computer Store



CALL TOLL FREE:
(800) 423-5387 USA
IN CALIF:
(800) 382-3651
LOCAL & OUTSIDE USA
(213) 886-9200



LEEDEX VIDEO 100 12" MONITOR

- Compatible with TRS-80, Apple, and most small computers!
- High resolution!

Low cost, yet high resolution (650 line). Compares favorably with monitors costing twice as much. Because of the fact that standard composite video input is utilized no RF modulator is needed an extremely sharp and stable picture is achieved. The video bandwidth is 12MHz + f-3db with a 75ohm input impedance.

Cat No. 1204 Leedex Monitor, 5139 18 lbs. **\$139**
Cat No. 1937 TRS-80 Leedex Cable kit, 6 oz. 53

HUB REINFORCING DISK PROTECTORS

- Protects disks and diskettes from wear!
- Repairs damaged disks!

Now you can save those "ruined" disks with simple insertion of our DISK PROTECTOR! Inserting a protector on a new disk will increase its life times over! Easy to install, just slip a protector ring onto the precision tool, then slip on the disk! No glueing, no drying time, no heat! One tool lasts indefinitely, each disk requires one protector ring.

Cat No.	Description	WT.	Price
2073	5 1/4" diskette tool	2 oz.	\$4.95
2074	5 1/4" diskette protector rings	3 oz.	50 for \$9.95
2075	8" disk tool	3 oz.	\$6.95
2076	8" disk protector rings	4 oz.	50 for \$13.95

Verbatim 5 1/4 DISKETTES

The most popular diskette in the world!

\$29/box of 10 2 for \$55

Cat No.	Type	Description
1147	525-10	Soft, TRS-80
1148	525-10	10 hole hard
		Apple, Northstar, HB
1149	525-16	16 hole hard, Micropolis

DISKETTE/DISK BINDERS

Organizes and protects your data files! 5 1/4" disks fit two per insert, 8" fit one per insert. Binders includes 10 inserts.

Cat No.	Description	Price
1650	5 1/4" binder	\$9.95
1651	8" binder	\$9.95
1653	extra 8" inserts	95
1652	extra 5 1/4" inserts	95

Novation "Cat" Acoustic Modem

The first quality compact modem designed specifically for the small computer user. Designed to transmit data over standard telephone lines, the Cat has many uses for business and hobbyist. Allows one terminal or computer to interface with others, permitting one access to data from remote locations. Hobbyists can exchange data and programs. Compatible with any Bell 103 modem and, of course, all

other Cats! Also perfectly compatible with the new Radio Shack modem (it's the same unit). Data exchange can occur at any speed up to 30 char/sec. Low profile case features switches for mode selection and operation, also for LED's displaying unit status. Acoustic self-test is standard. Complete and ready-to-use. Requires 110 VAC, 60Hz. Cat No. 1480 **\$169**

5 1/4" DRIVE ENCLOSURES

- Fits Shugart, MPI, Portec, and more!

Single enclosure is two-piece metal construction, beige-tone. Dual Enclosure is one-piece molded plastic, charcoal grey finish. **as low as \$25**

Cat No.	Description	Price
2055	Dual 1 1/2 lbs	\$59
2245	Single 2 lbs	\$25

8" Disks

\$37 box of 10

- IBM compatible
- Single density
- Individually certified

Cat No. 1145 Type 32-1000 Description 32 sector holes, 1-index hole
Cat No. 1146 Type 34-1000 interchangeable with IBM32, 3740, 3770, 3790, etc.

HOW TO ORDER

Pay by check, Mastercharge, Visa, or COD. Charge orders please include expiration date. Foreign pay in U.S. funds. Order by phone or mail, or at our retail. **MINIMUM ORDER \$10.** please include phone number and magazine/issue you are ordering from. Prices valid thru last day of cover date. **SHIPPING: USA:** add \$2.00 for the first 2 lbs. For ground add 35c for add'l lb. For air add 75c for add'l lb. **FOREIGN:** surface: add \$3.00 for first 2 lbs, 60c per add'l lb. Air: add \$11.00 for first 2 lbs, \$5 for each

add'l lb. **CODS \$1 add'l.** Guaranteed satisfaction for 120 days or your money back! Not responsible for typographical errors. Some items subject to prior sale. We reserve the right to limit quantities.

SEND FOR FREE CATALOG

FEATURING:

Computers and accessories, disk drives, printers, integrated circuits, LEDs, semiconductors, books, software, connectors, plus more and more! The widest selection at the lowest prices! Circle our reader service number or phonedwrite today for your copy!

S-100 TYPE EDGE CONNECTORS

- Imsai and Altair type spacing!
- Gold plated contacts
- Top USA makers!

Cat No.	Description	Sale
1376	Imsai type, soldertail	\$2.95
1428	Imsai type, wirewrap	\$4.25
1388	Altair type, soldertail	\$4.00

Order by Cat No.

as low as \$2.95

19511 Business Center Dr. Dept. B3 Northridge, Ca. 91324

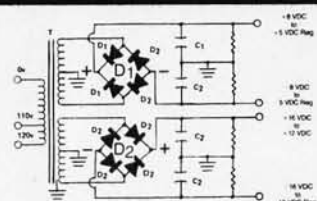

BUILD YOUR OWN LOW COST MICRO-COMPUTER POWER SUPPLIES FOR S-100 BUS, FLOPPY DISCS, ETC.

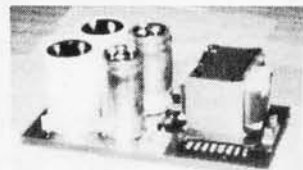

POWER TRANSFORMERS (WITH MOUNTING BRACKETS)

ITEM NO.	USED IN KIT NO.	PRI. WINDING TAPS	SECONDARY WINDING OUTPUTS			SIZE W x D x H	UNIT PRICE
			2x8 Vac	2x14 Vac	2x24 Vac		
T ₁	1	0V, 110V, 120V	2x7.5A	2x2.5A	—	3 3/4" x 3 3/8" x 3 1/8"	21.95
T ₂	2	0V, 110V, 120V	2x12.5A	2x3.5A	—	3 3/4" x 4 3/8" x 3 1/8"	27.95
T ₃	3	0V, 110V, 120V	2x9A	2x2.5A	2x2.5A	3 3/4" x 4 3/8" x 3 1/8"	29.95
T ₄	4	0V, 110V, 120V	2x4A	—	2x3A	3 3/4" x 3 3/8" x 3 1/8"	21.95

POWER SUPPLY KITS (OPEN FRAME WITH BASE PLATE, 3 HRS. ASSY. TIME)

ITEM	USED FOR	@+8 Vdc	@-8 Vdc	@+16 Vdc	@-16 Vdc	@+28 Vdc	SIZE WxDxH	UNIT PRICE
KIT 1	15 CARDS SOURCE	15A	—	2.5A	2.5A	—	12" x 6" x 4 7/8"	51.95
KIT 2	SYSTEM SOURCE	25A	—	3A	3A	—	12" x 6" x 4 7/8"	58.95
KIT 3	DISC SYSTEM	15A	1A	2A	2A	4A	14" x 6" x 4 7/8"	66.95
KIT 4	DISC SOURCE	8A	1A	—	—	5A	10" x 6" x 4 7/8"	49.95

EACH KIT INCLUDES: TRANSFORMER, CAPACITORS, RESIS., BRIDGE RECTIFIERS, FUSE & HOLDER, TERMINAL BLOCK, BASE PLATE, MOUNTING PARTS AND INSTRUCTIONS.

DISC DRIVE POWER SUPPLY "R3" ASSY. & TESTED, OPEN FRAME, SIZE: 9" (W) x 5" (D) x 5" (H) 59.95

SPECS: +5V @ 5A REGULATED, -5V @ 1A REG., +24V @ 5A REG., SHORTS PROTECT.

IDEAL FOR 2 SHUGART 801/851 OR SIEMANS FDD100-8/200-8 DISK DRIVES & ROCKWELL AIM-65.

SHIPPING FOR EACH TRANSFORMER: \$4.75. FOR EACH POWER SUPPLY: \$5.00 IN CALIF. \$7.00 IN OTHER STATES. CALIF. RESIDENTS ADD 6% SALES TAX. OEM WELCOME.



MAIL ORDER:
P.O. BOX 4296
TORRANCE, CA 90510

SUNNY INTERNATIONAL
(TRANSFORMERS MANUFACTURER)
Telephone: (213) 633-8327

STORE:
7245 E. ALONDRA BLVD.
PARAMOUNT, CA 90723
STORE HOURS: 9 AM-6 PM



STATIC RAM CHIPS
FACTORY PRIME From the same shipment we use in our professional quality boards.
 2114L 450 ns. \$5.90 200 ns. \$6.90
 4044 450 ns. \$5.90 250 ns. \$6.90
 Add \$5.00 Handling on Orders Under \$200.00

32K STATIC RAM BOARD
 FOR THE S550 AND S50C BUS (SWTP etc.)
 • S550C Extended Addressing (can be disabled).
 • 4 separate 8K blocks.
 • Low power 2114L RAMS (2 AMPS Typical for 32K).
 • Socketed for 32K.
 • Write Protect
 • Gold Bus Connectors

16K \$328.12
 24K \$438.14
 32K \$548.15

Phone, write, or see your dealer for details and prices on our broad range of Boards and Systems for the S550/S50C bus including our **UNIQUE 80x24 VIDEO BOARD**, and our AC Power Control Products for all computers.

GIMIX inc. 

1337 W. 37th Place • Chicago, IL 60609
 (312) 927-5510 • TWX 910-221-4055

The Company that delivers.
 Quality Electronic products since 1975.

GIMIX® and GHOST® are Registered Trademarks of GIMIX, INC.

Circle 260 on inquiry card.

ENGINEERING PROGRAMMERS
Don't Come To Mass...

Unless you enjoy challenging micro software development projects with some of the fastest growing commercial systems manufacturers in the U.S. Our clients offer generous salaries, flexible hours, profit sharing, etc. to experienced or degreed assembly programmers in areas such as communications, diagnostics, text editing, graphics, compiler, and O.S. design. Starting salaries 18-28K. All fees, relocation and interviewing expenses assumed by the companies.

Please contact Dave Adams (617) 246-2815 (collect calls accepted). N.E. Recruiters, 6 Lakeside Office Park, Wakefield, MA 01880.

Fee paid consultants

Circle 261 on inquiry card.

TWICE THE BYTE!



8" DISK CONTROLLER

APPLE DOS COMPATIBLE

- DOUBLES APPLE II™ STORAGE
- SHUGART 800/801 COMPATIBLE
- STANDARD IBM™ 3740 FORMAT
- CP/M™, UCSD PASCAL™ CAPABILITY

Available at your local APPLE Dealer: \$400.



SORRENTO VALLEY ASSOCIATES
 11722 SORRENTO VALLEY RD.
 SAN DIEGO, CA 92121

Circle 262 on inquiry card.



EVERYTHING YOU NEED TO BRING YOUR BASIC PROGRAMS TO LIFE WITH SOUND

System includes speaker/amplifier with volume control, connectors, DEMO and COMPOSER programs, and complete instructions for adding sound to BASIC programs.

PET & TRS-80 II—\$29.95, Compu-color II—\$39.95. VISA & MC. plus \$1.50 post. & handling. CA add sales tax. Send for free catalog of recreational software for PET and Compu-color II.



CAP Electronics,
 1884 Shulman Ave., Dept. B
 San Jose, CA 95124 (408) 371-4120

Circle 263 on inquiry card.

DES-MAR ELECTRONICS

2306 Remo Court
 Santa Clara, CA. 95054
 (408) 496-0692

BRAND NEW (PLUG IN & RUN)

TRS-80™ 16K LEVEL 2
\$699.00 DELIVERED

TRS-80 TOTAL COMPATIBLE

DISK DRIVES WITH CABLE
 (JUST PLUG IN & RUN)
\$399.00 DELIVERED

- *CHECKS OR MONEY ORDERS
- *PRESENT LEAD TIME: 2 WEEKS
- *CA. RESIDENTS 6.5% TAX

T.M. OF TANDY CORP.

Circle 264 on inquiry card.

GREAT PROGRAMS WANTED

We're Chafitz, makers of champion programs **SARGON** and **ARISTOTLE**. Our **MODULAR GAME SYSTEM** makes it possible to put **YOUR** program on a Module to plug into our Mainframe unit with its 8 digit, 14-segment alpha-numeric display, 20 key keyboard and rechargeable battery pack. If you have a **GREAT** program that is the best of its kind and/or a unique concept that will be exciting or challenging for youngsters or adults, then we want to hear from you.

Write to

Chafitz, Inc.

1055 First Street,
 Rockville, MD 20850
 Attention: Dan Neumayer

Circle 265 on inquiry card.

Product versatility and value

IN NEW YORK CITY

OHIO SCIENTIFIC & ARISTO/POLKS FULL STOCK AND SERVICE ON CHALLENGER MICRO-COMPUTERS.

CHALLENGER C1P 8K	\$399.00
C1P 5" FLOPPY 20K	\$198.00
SUPERBOARD C1P	\$279.00
CHALLENGER (COLOR) C4P 8K	\$698.00
C4P FLOPPY 24K 5"	\$1698.00
CHALLENGER C8P	\$895.00
COLOR-DUAL 8" FLOPPY C8P	\$2597.00
C-3 48K DUAL FLOPPY 8"	\$3995.00
C-3 • 23 MEG HARD DISK	\$9900.00
C-2-0EM 48K DUAL FLOPPY 8"	\$2699.00

PLUS ALL SOFTWARE & PERIPHERALS

Mail order invited if machine can be sent back to us for service. 220V conversions available for systems-write for quote. Write for free catalog. M/C, VISA, AX CARDS ACCEPTED.

Aristo/Polks • 212-279-9034
 314 5TH AVE. (32 ST) N.Y.C., N.Y. 10001
 9:30/6-DAILY ■ THURS TIL 9 ■ SUNDAY 11-5

Look to Aristo/Polks for reliability, quality, product versatility and value

Circle 266 on inquiry card.

TRS-80 Software for Investors

Supplement your stock market trading strategy with our new technical analysis package.

- Price cycle forecasting by time series analysis
- Moving averages
- Volume analysis
- Momentum analysis

Also available portfolio bookkeeping. Send for detailed information.

Ampero Software Products
 5230 Clark Ave., Suite 12A
 Lakewood, CA 90712

Circle 267 on inquiry card.

CP/M CHESS CP/M

- TYPING SERVICE** - Send us your SARGON I book and we supply expert typing services to disk. \$12.95 Note: If you do not have a book we will furnish a book with your services. ADD \$14.95
- ERROR CORRECTION SERVICE** - Service (a) above plus we correct all known errors in your source file. \$14.95
- ASSEMBLY SERVICE** - Service (b) above plus we assemble and supply object code for Jupiter III system w/8k. \$17.95
- ALTERATION AND MODIFICATION SERVICE** - Service (c) above plus we patch, and supply it to run on CP/M as a .COM object file. \$24.49
- CUSTOM GRAPHICS INTERFACE SERVICE** - Service (d) above plus we interface it to a custom Graphics Driver and supply it as a .COM object file. Specify your video board. (2x3 cell graphics w/ reverse video types only) \$39.44

Specify disk type:
 ANY 8" IBM - MICROPOLIS MOD II
 NORTHSTAR SD or DD - CROMEMCO 8" or 5"
 ADD \$6.00 FOR DISKETTE OR
 SEND US A BLANK WITH BOOK
 Calif. residents add 6% tax on diskette and book

THE OLD ASSOCIATION
 3744 PESCADERO DRIVE
 SANTA BARBARA, CA 93105
 (805) 682-8587

CP/M is a trademark of Digital Research Corp.

Circle 268 on inquiry card.



11542-1 KNOTT ST.
GARDEN GROVE,
CA 92641
(800) 854-6411
(714) 891-2663

IMSAI CONNECTORS
100 PIN - SOLDERTAIL
\$3.00 each
10 for **\$2.75** each

2708's
450NS
\$8.50 ea.
or
8/\$60

MICROBYTE 16K RAM BOARD	MICROBYTE 32K RAM BOARD
<ul style="list-style-type: none"> FULLY S-100 COMPATIBLE USES LO-PWR 4KX1, MM5257's 2 MHZ OR 4 MHZ 4K BANK ADDRESSABLE EXTENDED MEMORY MANAGEMENT NO DMA RESTRICTIONS ASSEMBLED & TESTED 2MHZ \$250 - 4MHZ \$265 	<ul style="list-style-type: none"> FULLY S-100 COMPATIBLE USES LO-PWR 4KX1, MM5257's 2MHZ OR 4MHZ BANK ADDRESSABLE EXTENDED MEMORY MANAGEMENT 8-BIT OUTPUT PORT NO DMA RESTRICTIONS ASSEMBLED & TESTED 2MHZ \$525 - 4MHZ \$540

LO-PRO SOCKETS

	1-24	25-99	100 up
14 PIN	.15	.14	.13
16 PIN	.16	.15	.14
18 PIN	.19	.17	.15
20 PIN	.27	.25	.23
24 PIN	.35	.31	.27
28 PIN	.40	.33	.29
40 PIN	.50	.46	.41

4116's
(250NS)
ADD ON MEMORY FOR APPLE, TRS 80, HEATH, ETC.
8 for \$64.00
or
16 for \$120.00

CERAMIC CAPS
.1 @ 12 VOLTS
10¢ ea.
or
100/\$9.00

2114's

REGULATORS	MISC. COMPONENTS			
320T-5..... .90	LM33970	1-9	10-99	100 up
320T-12.... .90	LM348... 1.00		.65	.59
340T-5..... .80	LM377... 1.10		.92	.85
340T-12.... .70	LM380... .80		1.00	.95
78H05..... 4.75	LM3900... .55		.75	.70
78L12..... .35	DM8216... 2.10		2.00	1.90
	8080A ... 4.50		4.25	4.00
	8251 ... 5.00		4.80	4.50

SA800 DISK DRIVE
INSTALLED IN DUAL CABINET W/PWR SUPPLY ASSEMBLED & TESTED
(1) DRIVE INSTALLED
\$695.00
(2) DRIVES INSTALLED
\$1125.00

2716's
5-VOLT ONLY
450 NS.
\$32.00 ea.
or
8 for \$240

LO-PWR 300 NS.
1-16 PCS.
\$5.25 ea.
17 UP
\$5.00 ea.

ASK FOR OUR NEW CATALOG	ORDERING INFO	TERMS
	NAME, ADDRESS, PHONE SHIP BY: UPS OR MAIL SHIPPING CHR.G: ADD \$2.50 UP TO (5) LBS. CREDIT CARDS WILL BE CHARGED APPROPRIATELY	WE ACCEPT CASH, CHECK, MONEY ORDERS, VISA & MASTER CHR.G. (U.S. FUNDS ONLY) TAX: 6% CALIF. RES.

BECKIAN ENTERPRISES

ALL PRIME QUALITY — NEW PARTS ONLY
SATISFACTION GUARANTEED.

EDGE CARD CONNECTORS: GOLD PLATED:

Abbreviations: S/E Solder Eye . S/E Sold Tail: W/W Wire Wrap.

PART # DESCRIPTION.	Row Sp.	1-9pc.	10-24pcs.	25pcs. Up.	.156" CONTACT CENTER CONNECTORS.			'D' TYPE SUBMINIATURE CONNECTORS.							
BRAND: TEXAS INST.					PART # DESCRIPTION.	Row Sp.	1-9pc.	10-24pcs.	25pcs. Up.	PART NUMBER	DESCRIPTION.	1-9pc.	10-24pcs.	25-99pcs.	
4070	50/100	Imnai/Crom.	.250	\$3.95ea.	15105	8/12 S/E PET/NSC	.140	\$1.80	\$1.65	\$1.45	DE 9P	Male	\$1.80ea.	\$1.40ea.	\$1.30ea.
4090	50/100	Imnai W/W	.250	4.30ea.	15110	8/12 S/T PET/NSC	.140	1.85	1.65	1.50	DE 9S	Female	2.25ea.	2.00ea.	1.90ea.
BRAND: SULLINS: U.L. Reg.					15137	8/12 S/T PET/NSC	.200	1.80	1.54	1.45	DE 110983-1	2 pc. Grey Hood.	1.50ea.	1.35ea.	1.20ea.
129885	50/100	Solder Eye	.140	6.80ea.	15175	6/ S/E Sgle Row	.140	1.70	1.50	1.30	DA 15P	Male	2.35ea.	2.15ea.	2.00ea.
129870	50/100	S/T Imnai	.250	4.50ea.	15270	10/20 S/E	.140	2.15	1.95	1.70	DA 15S	Female	3.25ea.	3.10ea.	2.90ea.
129875	50/100	W/W Imnai	.250	5.25	15275	10/20 S/T	.140	2.00	1.85	1.60	DA 51211-1	1 pc. Grey Hood	1.40ea.	1.20ea.	1.15ea.
129885	50/100	S/T Altair	.140	4.95	15435	12/24 S/E PET	.140	2.60	2.35	2.10	DA 51226-1	2 pc. Black Hood	2.50ea.	2.25ea.	2.00ea.
129990	50/100	S/T Cromem.	.250	4.75	15440	12/24 S/T PET	.140	2.65	2.40	2.15	DA 110983-2	2 pc. Grey Hood	1.60ea.	1.35ea.	1.30ea.
OTHER .125" CONTACT CTR CONNECTORS:					15445	12/24 S/T PET	.200	2.75	2.50	2.20	DB 25P	Male	2.80ea.	2.60ea.	2.40ea.
12305	22/44	S/E No Ears	.140	4.15	15505	15/30 S/E GRI Key	.140	2.50	2.25	2.00	DB 25S	Female	3.60ea.	3.40ea.	3.20ea.
12759	36/72	S/T	.140	5.40	15510	15/30 S/T GRI Key	.140	2.40	2.15	2.95	DB 51212-1	1 pc. Grey Hood	1.50ea.	1.30ea.	1.10ea.
12790	40/80	W/W	.250	6.30	15515	15/30 W/W GRI Key	.200	2.60	2.35	2.10	DB 51226-1	2 pc. Black Hood	1.90ea.	1.85ea.	1.45ea.
.100" CONTACT CTR CONNECTORS:					15600	18/36 S/E	.140	3.35	3.05	2.70	DB 110983-3	2 pc. Grey Hood	1.75ea.	1.50ea.	1.35ea.
10048	13/26	S/E No Ears	.140	3.40	15610	18/36 S/T	.140	3.00	2.70	2.40	DC 37P	Male	4.20ea.	4.00ea.	3.70ea.
10280	25/50	S/E TRS 80	.140	4.50	15615	18/36 W/W	.200	3.60	3.20	2.90	DC 37S	Female	6.00ea.	5.75ea.	5.50ea.
10175	20/40	S/E TRS 80	.140	5.85	15700	22/44 S/E KIM/VEC	.140	2.98	2.90	2.75	DC 110983-4	2 pc. Grey Hood	2.25ea.	2.00ea.	1.75ea.
10180	20/40	W/W TRS 80	.200	3.30	15705	22/44 S/T KIM/VEC	.140	3.98	3.30	3.00	DD 50P	Male	5.50ea.	5.10ea.	4.75ea.
10190	20/40	S/T TRS 80	.140	3.20	15710	22/44 W/W KIM/VEC	.200	3.49	3.20	2.85	DD 50S	Female	9.40ea.	8.60ea.	8.00ea.
10485	36/72	S/E Vector	.140	5.50	15875	25/50 S/E	.140	4.85	4.20	3.75	DD 51218-1	1 pc. Grey Hood	2.40ea.	2.20ea.	2.00ea.
10490	36/72	W/E Vector	.200	5.80	15880	25/50 S/T	.140	4.55	4.10	3.85	DD 110983-5	2 pc. Grey Hood	2.60ea.	2.40ea.	2.10ea.
10500	36/72	S/T Vector	.140	5.70	15885	25/50 W/W	.200	4.85	4.35	3.90	D 20418-2	Hardware Set (1 Hood Set)	.90ea.	.80ea.	.70ea.
10535	40/80	S/E PET	.140	5.85	16115	36/72 S/E	.140	6.50	5.85	5.20					
10540	40/80	W/W PET	.200	6.00	16120	36/72 S/T	.140	6.55	5.90	5.25					
10550	40/80	S/T PET	.140	5.80	16125	36/72 W/W	.200	6.75	6.10	5.40					
10585	43/86	S/E COS/ELF	.140	6.95	16145	36/72 S/T	.200	6.50	5.85	5.20					
10605	43/86	S/T COS/ELF	.140	6.60	16235	43/86 S/T Mot 6800	.140	6.60	5.95	5.30					
10595	43/86	W/W COS/ELF	.200	6.90	16240	43/86 W/W Mot 6800	.200	7.80	7.05	6.25					
10615	43/86	S/T COS/ELF	.200	6.80	16260	43/86 S/T Mot 6800	.200	6.50	5.85	5.20					
					16725	43/86 S/E Mot 6800	.140	7.20	6.50	5.75					

I.C. SOCKETS GOLD. W/WRAP 3 TURN 14 pin \$0.40 ea. 16 pin 0.44 ea.	I.C. SOCKETS TIN. 14 pin \$0.15 ea. 16 pin 0.17 ea.	COOLING FANS. Extra Quiet. 1 to 4 \$18.00 ea. 5 to 9 17.00 ea.
8080A PRIME. \$8.00 ea.	CONNECTORS FOR CENTRONICS 700 SERIES. Amphenol 57-30360 1 to 4 pcs. \$9.00 ea. 5 to 9 pcs. 7.00 ea.	
EIA 8 CONDUCTOR CABLES 8ft. Long. CLASS #1 Type Cables. 1. to 4 pcs. \$23.00 5 to 9 pcs. 20.00		

TERMS: MINIMUM ORDER: \$15.00 ADD \$1.35 For Handling & Shipping. Orders over \$30.00 in the U.S.A. We Pay the Shipping. CALIF. RESIDENTS: Please Add 6% Sales Tax.
NOTE: NO C.O.D. OR CREDIT CARD ORDERS WILL BE ACCEPTED.

BECKIAN ENTERPRISES
P.O. BOX #3089
SIMI VALLEY, CA 93063

MAIL ORDERS TO:

CP/M* Source Code - FREE! when you purchase "OS-1"
 Electrolabs' new operating system for the Z-80 designed to have exactly
 the appearance of UNIX**, including virtual I/O, "set TTY", a tree and a
 shell, filters and pipes PLUS total compatibility with CP/M software!

OS-1[®] FEATURES

(Because OS-1 is truly a comprehensive "OS", and not merely a file handling "DOS", we have changed the name from "Superdos" to "OS-1")

- VIRTUAL I/O** - copy with a single command between floppy and hard disk, or from TTY to printer to tape to disk... etc., etc.
 No messy I/O routines to write, & no awkward transfers.
- SECURITY** - 9 modes of file protection, user and login protection.
- MULTI-USER** - up to 256 passwords. (non-simultaneous users)
- 16MBy FILE SIZE** - but no limit to no. of directories per device, thus allowing EASY implementation of gigantic storage devices.
- "SET TTY"** - for printer or crt: tabs, page width, buffer, cursor, UC/LC, fonts, formfeed, arbitrary control characters etc., etc.
- "LOGIN"** - automatically executes user selected programs and "set TTY".
- OCCUPIES 12KBy** - only 50% larger than CP/M, but 500% more features.
- CP/M & CDOS COMPATIBLE** - your library is guaranteed to run!

* (Naturally, we are not giving away the version of CP/M written by Digital Research, Please pardon our pun, but they might object. What we ARE giving you is a greatly enhanced version of CP/M which resides on OS-1, and allows the user of OS-1 to run any and all of his programs, packages or system utilities which are already running on CP/M. We give you the source code at no charge so that you may modify any part of the CP/M to suit your own system requirements. At no charge, you also receive the enhancement allowing 4MBy files instead of 256K.)

OS-1 (with debugger, linker and screen oriented editor)	\$199.00
Update service, per year	29.00
Symbolic Debugger	150.00
MACRO-Assembler (Creates relocatable code)	150.00
"C" Compiler	660.00
FORTRAN Compiler	100.00
BASIC Compiler (very fast)	350.00

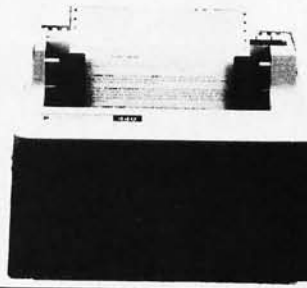

- PAPER TIGER**
IDS MODEL 440
 - 8 Software Selectable Character Sizes
 - Parallel & Serial Interface
 - 98 ASCII Character set, upper & Lower case
 - Forms length control
 - Tractor Feed \$949.00
 Graphics option with 2K CRT screen buffer add \$199.00

DYNAMIC DEVICES MODEM

- Acoustically coupled modem assembly set
- Asynchronous 0-300 Baud
- Switchable originate or answer modes
- Operates full or half duplex mode
- 15 minute assembly \$149.95



SPRINGTIME IC SPECTACULAR

(While Supply Lasts)	4116 (set of 8, 16K, mem-)	2732	95.00
MEMORY & EPROM	Apple, Exidy)	8748-8	49.00
2114	\$ 5.99	8755-8	49.00
2114-2	6.99	CPU	
pd 411	2.50	6502	6.25
2107	2.00	Z-80	9.95
		Z-80A	12.05
		8080A	8.99
		8085	22.00
		8741	79.00

ELECTROLABS
 POB 6721 Stanford, CA 94305
 415-321-5601 800-227-8266
 Telex: 345567 (Electrolab Pla)

- FLOPPY CONTROLLERS**
 1771 \$26.95
 1791 37.95
 Pd372 39.00
- MISCELLANEOUS (CALL US!!)**

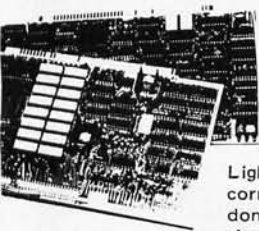

Graphics

High Resolution 480 x 512 for B&W and Color Imaging and Graphics

Light pen, A-D, D-A, TV synchro (needs no time base correction or adjustment with anything between random interface & NTSC commercial standard). T.V. single frame grabber ("snapshot"). Up to 1 Byte of attributions per pixel.

LSI-100 & S-100 applied to:

Graphic Presentation - such as computer generated animation & other graphic displays up to 256 colors & up to 256 b&w gray scales. **Image Analysis** - using built-in FRAME GRABBER, for medical image enhancement, contour analysis, & pattern recognition. **Commercial TV Tilting & Advertising** - using synchronization capability. **Interactive graphics** - using light pen accessory.

BASIC CONFIGURATION -

LSI-11 \$1995. S-100 \$1265.
 For TRS-80/Exidy Add \$595.00
 Includes: Data Board - 32K (480 x 512 x 1 pixel) D-A 16 level video generator, Video Synchronization Circuitry, Address Control & Timing Board.

FEATURES -

High speed. DMA or 2KBy window memory mapped interface. Full NTSC commercial color capability. Low power consumption. Excellent Software Options - Accessories - Software
 Options include: light pen, auxiliary outputs, text mode, memory and much more. Accessories include: b&w and color cameras and monitors, Software: "Plot" 2D or 3D, "Tilting", "Contour", "Image Enhancement", "Vector Curve Generation".

Call for price and details

*CPM and **UNIX trademarks of Digital Research and Western Electric respectively.

Circle 272 on inquiry card.

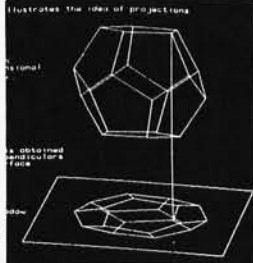
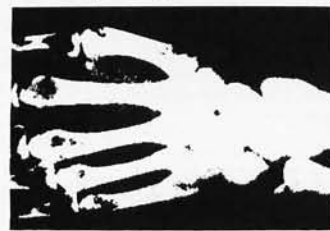

MATCHMAKER TECHNOLOGY

TURNKEY DISK SUBSYSTEMS

DISK IS IN!!!

For those who wish to avoid the aggravation, fussing, irritation, annoyance etc., of assembling your own subsystem, plug in and GO!!!



- ✓ SORCERER
- ✓ TRS-80
- ✓ APPLE
- ✓ HPIB
- ✓ PET

APPLE

FEATURES:

- 2 8" Floppy DISK DRIVES (Single Sided)
- Color Coordinated Cabinet with Power Supply
- Expanded version of APPLE-DOS
- Single Density Disk Controller
- Full Cabling, Connectors + Documentation
- Assembled and Tested
- Plug In and GO!!! \$1695.00

OPTIONS:

- 2 8" Double Sided Drives (In place of Single Sided) \$2395.00
- 16K Internal Memory Expansion Kit 69.00

PET

Prices and specifications same as for APPLE except PET Operates via PET-DOS

SORCERER

FEATURES:

- 2 8" Single Sided Floppy Disk Drives
- Single and/or Double Density
- Color Coordinated Cabinet with Power Supply
- Full RS-232 Interface
- OS-1 Disk Operating System (Fully CP/M compatible) CP/M is a registered trademark of Digital Research
- Full Cabling, Connectors + Documentation
- Assembled and Tested
- One S-100 Slot available for Memory Expansion
- Plug In and GO!!! \$2195.00

OPTIONS:

- 2 8" Double Sided Drives (In place of Single Sided) \$2845.00
- 32K Dynamic RAM Memory Board, Assembled and Tested \$ 299.00
- 16K Dynamic RAM Internal Memory Expansion Kit \$ 69.00

TRS-80

Prices and specifications same as for SORCERER with following exceptions:

- Expansion Interface necessary
- Space for up to 48K plug-in dynamic memory on Controller Card
- Software package as above \$ 995.00

ANOTHER Fine Product brought to you exclusively by the folks at:

In California: 415-321-5601
 Outside Cal: 800-227-8266

Electrolabs
 POB 6721, Stanford, Ca. 94305

Worldwide:
 TLX: 345567 Electrolabs PLA

SEND FOR OUR NEW 1980 CATALOG TODAY

OUR BEST SELLING MEMORY EXPANDORAM

EXPANDABLE TO 64K USING 4116 RAMS

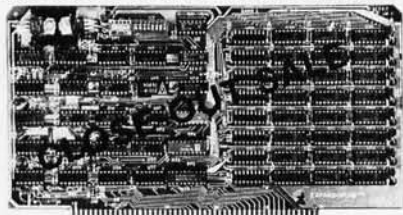

Interfaces with most popular S-100 boards
Bank selectable; PHANTOM provision
Draws only 5 watts fully populated
Designed to work with Z-80, 8080, and 8085 systems
No wait states required
16K boundaries & protect via dip switches
Kits come with sockets for full 64K
Invisible refresh

MEM-16130K (16K KIT)	\$239.95
MEM-16130A (16K A&T)	\$289.95
MEM-32131K (32K KIT)	\$309.95
MEM-32131A (32K A&T)	\$359.95
MEM-48132K (48K KIT)	\$379.95
MEM-48132A (48K A&T)	\$429.95
MEM-64133K (64K KIT)	\$449.95
MEM-64133A (64K A&T)	\$499.95

SOLID STATE MUSIC PB-1

EPROM PROGRAMMER FOR 2708 OR 2716
MEM-99510K(KIT)
 \$125.00 || MEM-99510A(A & T) | \$175.00 |

VECTOR GRAPHICS HI-RES GRAPHICS

256X240 S-100 HI-RES GRAPHICS BOARD
IOV-1070K(KIT)
 \$150.00 || IOV-1070A(A & T) | \$199.95 |

SOLID STATE MUSIC I/O-4

2 SERIAL & 2 PARALLEL I/O PORTS
IOI-1010K(JADE KIT)
 \$149.95 || IOI-1010A(A & T) | \$199.95 |

S D SYSTEMS SBC-100/200 2 OR 4 MHz SINGLE BOARD COMPUTER

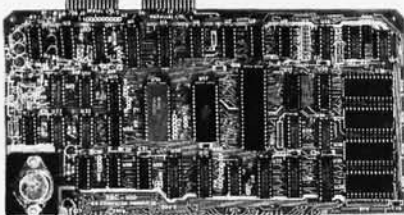

S-100 bus compatible Z-80 CPU
1K of on-board RAM
4 EPROM sockets accommodates 2708, 2716, or 2732
One parallel and one serial I/O port
4-channel counter timer chip (Z-80 CTC)
Software programmable serial baud rates
CPC-30100K (2 MHz KIT)
 \$249.95 || CPC-30100A (2 MHz A&T) | \$299.95 |
| CPC-30200K (4 MHz KIT) | \$289.95 |
| CPC-30200A (4 MHz A&T) | \$339.95 |

GET THE INSIDE TRACK JADE DOUBLE-D DOUBLE DENSITY DISK CONTROLLER

Read/write single or double density, 8" or 5 1/4" drives
On board Z-80 insures reliable operation
CP/M compatible in either single or double density
Density is software selectable
Up to 4 single or double sided, single or double density drives may be mixed on the same system
EIA level serial printer interface on-board-up to 9600 baud (perfect for despooling operations)
All the hard work of disk access is done by the on board Z-80A and 2K memory, leaving your host CPU free for its normal duties
Uses IBM standard formats for proven reliability
THIS BOARD REALLY WORKS !!!!!
IOD-1200K (DOUBLE-D KIT)
 \$285.00 || IOD-1200A (DOUBLE-D A&T) | \$349.00 |
| IOD-1200D (MANUAL ONLY) | \$15.00 |

S D SYSTEMS VERSAFLOPPY II DOUBLE DENSITY DISK CONTROLLER

Single or double density floppy disk controller
985600 bytes on 8" double sided diskettes
259840 bytes on double sided 5 1/4" diskettes
S-100 bus (IEEE) standard compatible
IBM 3740 format in single density
8" and 5 1/4" drives controlled simultaneously
Operates with Z-80, 8080, and 8085 CPU's
Controls up to 4 drives
Vectored interrupt operation optional
IOD-1160K (KIT)
 \$335.95 || IOD-1169A (A&T) | \$385.95 |

S D SYSTEMS VERSAFLOPPY VERSATILE FLOPPY DISK CONTROLLER

IBM 3740 soft sectored format
S-100 Z-80 or 8080 compatible
Controls up to 4 single or double sided drives
Compatible with all popular disk drives
CP/M compatible
Listings for control software included
IOD-1150K (KIT)
 \$189.95 || IOD-1150A (A&T) | \$239.95 |

NEW DISK OPERATING SYSTEM SDOS IS HERE

WE THINK IT'S SUPERIOR
SDOS is a CP/M compatible operating system designed for the S.D. Sales Versafloppy I or II. It requires the SBC-100/Versafloppy board set and functions as a superset of CP/M, giving 19 additional functions including file attributes, disk label, and read/write logical blocks. It provides additional protection features, and is expandable to a multi-user real-time system.
SDOS sells for \$200.00

CALL FOR SALE PRICES !!! 32K STATIC RAM EXPANDABLE 8K/32K, 2/4MHz, KIT/A&T

NEW 2 OR 4 MHz REV. C BOARD THE JADE BIG Z

Z-80 CPU BOARD WITH SERIAL I/O PORT
2 or 4 MHz switchable, on-board 2708, 2716, or 2732 EPROM useable in SHADOW mode (full 64K RAM)
Automatic MWRITE generation if no front panel
On-board USART for sync or async RS232
CPU-30201K (KIT)
 \$159.00 || CPU-30201A (A & T) | \$209.00 |

S D SYSTEMS EXPANDORAM II 4 MHz RAM BOARD EXPANDABLE TO 256K

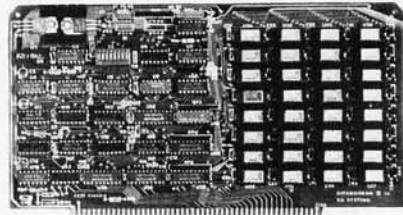

S-100 bus compatible, up to 4 MHz operation
Expandable memory from 16K to 256K
Dip switch selectable boundaries
Page-mode allows up to 8 boards on the same bus
Invisible refresh; PHANTOM output disable
Designed to operate in Z-80 based systems
MEM-16631K (16K KIT)
 \$295.95 || MEM-16631A (16K A&T) | \$345.95 |
MEM-32632K (32K KIT)	\$369.95
MEM-32632A (32K A&T)	\$419.95
MEM-48632K (48K KIT)	\$444.95
MEM-48632A (48K A&T)	\$494.95
MEM-64632K (64K KIT)	\$519.95
MEM-64632A (64K A&T)	\$569.95

VECTOR GRAPHICS 12K PROM/RAM 1K OF STATIC RAM AND 12 2708 SOCKETS MEM-12340A(A & T, NO PROMS) \$135.00 |

BEST BUY RATED TV-1 ONLY \$7.95 OUR BEST SELLING R. F. MODULATOR

GET YOUR "ROCKS" OFF..THE SHELF CRYSTAL SALE WE STOCK 40 STANDARD FREQ. 3 FOR \$12

TIMELY SPECIAL 60 Hz TIME BASE CRYSTAL CONTROLLED KIT ONLY \$4.95

COMING SOON NEW JADE P/S I/O

PARALLEL/SERIAL/INTERRUPT BOARD
Z-80 SIO/PIO, 2 CTCs, expands to 2 SIOs, 4 CTCs
4 serial ports (async, sync, bisync, SDLC/HDLC)
2 parallel ports with full handshake
Software baud rate generators, interval timers, counters, and generates 32 vectored interrupts
Designed especially for MP/M multi-user multi-tasking operating systems. For use with Z-80 only
IOI-1045B (BARE BOARD)
 \$45.00 || IOI-1045K (KIT) | \$169.95 |
| IOI-1045A (A & T) | \$224.95 |

SALE SALE SALE SALE SALE EPROMS BUY NOW AND SAVE

1702A	\$4.95
2708	\$8.95
2516	\$34.95
2716(T.I.)	\$34.95
2716(5 VOLT)	\$34.95
2758	\$34.95
2532	\$74.95
2732	\$74.95

CALL FOR PRICING ON LARGE QUANTITIES

PRICES SLASHED FOR MARCH ! CALL TOLL-FREE AND SAVE

800-421-5809 CONTINENTAL U.S.

800-262-1710 INSIDE CALIFORNIA

TERMINAL SALE ADDS REGENT

OUR FINEST LINE OF TERMINALS

ADDS REGENT 20	\$795.00
ADDS REGENT 25	\$850.00
ADDS REGENT 40	\$1195.00
ADDS REGENT 60	\$1495.00

SPECIAL PACKAGE PRICE RS-232 SET \$6.50

1 MALE DB-25, 1 FEMALE DB-25, 1 COVER

MICRO WORKS 2708 PROGRAMER

FITS STANDARD SWPT 6800 I/O SLOT
LIMITED SUPPLY(A & T) \$75.00

VECTOR GRAPHICS S-100 CARD CAGE

17" RACK WITH 18 SLOT MOTHERBOARD
ENC-118100(A & T) \$210.00

SPECIAL CLEARANCE SALE 4K EPROM BOARD

HOLDS UP TO 16 INEXPENSIVE 1702A's
MEM-04220K(KIT NO PROMS) \$45.00
MEM-04220A(A & T NO PROMS) \$79.95

CP/M 2.0

Digital Research has done it again! This new release of their industry standard disk operating system is bound to be an even bigger hit than the original version. All of the fundamental file-size restrictions of release 1 have been eliminated, while maintaining full compatibility with the earlier versions. This new release can be field-configured by the user for a single mini-disk up through a multiple drive hard-disk system with 128 megabyte capacity. Field configuration can be accomplished easily through use of the Macro Library (DISKDEF) provided with CP/M 2.0.

A powerful operating system for only ... \$150.00

JADE'S NEW MOTHERBOARDS THE ISO-BUS

WE'RE PROUD OF OUR MOTHER !

6-SLOT

BARE BOARD	\$24.95
KIT	\$49.95
ASSEMBLED & TESTED	\$59.95

12-SLOT

BARE BOARD	\$39.95
KIT	\$89.95
ASSEMBLED & TESTED	\$99.95

18-SLOT

BARE BOARD	\$59.95
KIT	\$129.95
ASSEMBLED & TESTED	\$149.95

SPECIAL PACKAGE PRICE ROCKWELL AIM-65

THE HEAD-START IN MICROCOMPUTERS

KIM-1 compatible
On-board printer
Full ACSII keyboard



AIM-65 w/1K RAM..	\$375.00
AIM-65 w/4K RAM..	\$450.00
8K BASIC ROM..	\$100.00
POWER SUPPLY..	\$59.95
CASE for AIM-65..	\$49.95
4K Assembler/Editor..	\$80.00

Special Package Price \$599.00

4K AIM-65, 8K BASIC ROM, Power Supply, and Case.

JADE MEMORY EXPANSION KITS FOR

TRS-80 APPLE EXIDY

Everything you need to add 16K of memory to your computer. Your kit comes neatly packaged with easy to follow instructions. In just minutes your computer is ready to tackle more advanced software.

\$69.00

SALE SALE SALE SALE SALE TRANSISTORS

LOOK UP THE SPECS AND STOCK UP

2N456A	10/\$1.00
2N718	10/\$1.00
2N2222A	5/\$1.00
2N3392	10/\$1.00
2N3741	2/\$3.00
2N3904	8/\$1.00
2N4013	20/\$1.00
2N4348	3/\$5.00
2N5088	5/\$2.00
2N5434	5/\$1.00
2N5449	5/\$1.00
2N6569	4/\$1.00
3N81	5/\$1.00

MICROPROCESSORS		6800 PRODUCT	
F8	\$16.95	6821P	\$5.25
Z80 (2MHz)	\$10.95	6828P	\$12.00
Z80A (4MHz)	\$14.95	6834P	\$16.95
CDP1802CD	\$24.95	6850P	\$4.80
6502	\$11.95	6852P	\$7.50
6800	\$12.50	6860P	\$9.25
6802	\$20.00	6862P	\$12.00
8008-1	\$15.95	6875L	\$7.30
8035	\$24.00	6880P	\$2.50
8035-8	\$24.00	CHARACTER GENERATORS	
8080-A	\$10.00	2513 Upper	\$7.95
8085	\$23.00	2513 Lower	\$6.75
TMS9900TL	\$49.95	2513 Upper (5 volt)	9.75
8080A SUPPORT DEVICES		2513 Lower (5 volt)	\$13.00
B212	\$5.00	MCM6571 up scan	\$13.00
B214	\$4.65	MCM6571A down scan	\$10.95
B216	\$2.95	PROMS	
B224 (2MHz)	\$4.30	1702A	\$5.00
B226	\$2.75	2708	\$8.95
B228	\$6.40	2716	\$39.95
B238	\$6.40	2716 (5v)	\$39.95
B243	\$8.00	2758 (5v)	\$30.00
B251	\$7.50	DYNAMIC RAMS	
B253	\$20.00	4116/416D	8 for \$74.95
B255	\$6.40	2104/4096	\$4.75
B257	\$19.95	2107B-4	\$3.95
B259	\$19.95	TMS4027/4096	\$4.75
B275	\$69.95	STATIC RAMS	
B279	\$17.70	21L02 (450ns)	\$1.50
USRT		21L02 (250ns)	\$1.75
S2350	\$10.95	2101-1	\$2.95
UARTS		2111-1	\$3.25
AY5-1013A	\$5.25	2112-1	\$2.95
AY5-1014A	\$8.25	2114L (450ns)	\$5.75
TR1602B	\$5.25	2114L (300ns)	\$5.95
TMS6011	\$5.95	TMS4044 (450ns)	\$8.00
IM6403	\$9.00	TMS4044 (300ns)	\$9.95
BAUD RATE GENERATORS		410D (200ns)	\$9.95
MC14411	\$10.00	4200A (200ns)	\$9.95

INTEGRAL DATA SYSTEMS THE PAPER TIGER

132 COLUMN DOT MATRIX PRINTER

Up to 198 CPS
1.75 to 9.5 inch adjustable tractor and friction feed.
Parallel and serial interface.

98 character ASCII set.
80 to 132 columns.
6 or 8 lines per inch.
Eight software selectable character sizes.
110, 300, 600, or 1200 baud.

PRM-33440 \$950.00
PRM-33441(GRAPHICS & 2K BUFFER) \$1050.00



SPECIAL
SALE
PRICE

GUARANTEED PREMIUM QUALITY JADE DISKETTES

MAGNIFICENT MAGNETIC MEDIA !

5 1/4" single sided, single density, box of 10	
MMD-5110103 (SOFT SECTOR)	\$29.95
MMD-5111003 (10 SECTOR)	\$29.95
MMD-5111603 (16 SECTOR)	\$29.95
5 1/4" double sided, double density, box of 10	
MMD-5220103 (SOFT SECTOR)	\$39.95
8" single sided, single density, box of 10	
MMD-8110103 (SOFT SECTOR)	\$34.95
8" single sided, double density, box of 10	
MMD-8120103 (SOFT SECTOR)	\$55.95
8" double sided, double density, box of 10	
MMD-8220103 (SOFT SECTOR)	\$57.95

SPST DIP SWITCHES



PART NUMBER	NUMBER OF SWITCHES	PRICE
SWD-103	3	\$1.00 \$1-18
SWD-104	4	\$1.05 \$1-20
SWD-105	5	\$1.10 \$1-24
SWD-106	6	\$1.15 \$1-28
SWD-107	7	\$1.20 \$1-30
SWD-108	8	\$1.25 \$1-34
SWD-109	9	\$1.30 \$1-36
SWD-110	10	\$1.35 \$1-38

SALE



TEXTTOOL ZIP* DIP II SOCKETS

16 PIN ZIP* DIP II	\$5.50
24 PIN ZIP* DIP II	\$7.50
40 PIN ZIP* DIP II	10.25

* ZERO INSERTION PRESSURE

SPECIAL PRICE FOR MARCH NOVATION CAT

ACOUSTIC COUPLER/MODEM

\$157.50

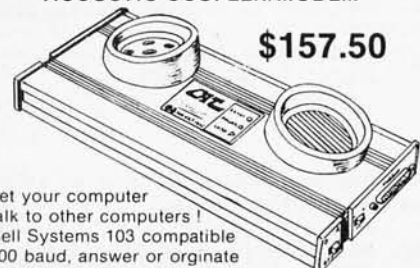

Let your computer talk to other computers !
Bell Systems 103 compatible
300 baud, answer or originate

IOM-5200A (SALE PRICED) \$157.50

JADE Computer Products

4901 W ROSECRANS, HAWTHORNE, CA 90250
213-679-3313

PLACE ORDERS TOLL FREE

800-262-1710 800-421-5809
INSIDE CALIFORNIA CONTINENTAL U.S.

WRITE FOR OUR FREE 1980 CATALOG
FOR CUSTOMER SERVICE OR TECHNICAL INQUIRIES
CALL 213-679-3317

TERMS OF SALE: Cash, checks, money orders, and credit cards accepted. Minimum order \$10.00. California residents add 6% sales tax. Minimum shipping and handling charge \$2.50. Prices are for U.S. and Canadian delivery only and are subject to change without notice. For export prices and information send for a JADE INTERNATIONAL CATALOG.



RN IDH Series - Headers

PC Mounting

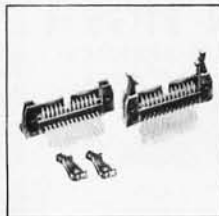

Pins	Straight	Right Angle	1-9	10-24	25-99
10	IDH-10S	IDH-10SR	.95	.72	.70
20	IDH-20S	IDH-20SR	1.30	1.15	1.10
26	IDH-26S	IDH-26SR	1.75	1.50	1.35
34	IDH-34S	IDH-34SR	2.25	1.95	1.75
40	IDH-40S	IDH-40SR	2.55	2.35	2.15
50	IDH-50S	IDH-50SR	3.25	2.95	2.75

Wire Wrap

Pins	Straight	Right Angle	1-9	10-24	25-99
10	IDH-10W	IDH-10WR	1.95	1.65	1.55
20	IDH-20W	IDH-20WR	2.75	2.50	2.40
26	IDH-26W	IDH-26WR	3.50	3.25	3.15
34	IDH-34W	IDH-34WR	4.25	3.95	3.75
40	IDH-40W	IDH-40WR	4.75	4.50	4.25
50	IDH-50W	IDH-50WR	5.95	5.60	5.40

Ejector Ears for above. 4/\$1.00 20/\$3.00 100/\$10.00

- Header is permanently mounted on PCB and accepts IDS socket connectors.
- Straight or right angle mounting options available for both solder and wrap pin terminations.

- Solder termination length for either .062" or .125" PCB.
- Ejector/Latch available, latches IDS socket in place when closed, serves as ejector when open.

IDC Card Edge Connectors

Pins	1-9	10-24	25-99
20	4.15	3.75	3.30
26	4.75	4.30	3.80
34	5.70	5.10	4.50
40	6.50	5.80	5.25
50	7.00	6.30	5.40

25 Pin 'D' Subminiature

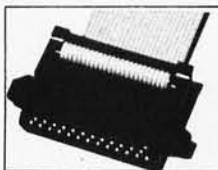

	1-9	10-24	25-99
Plug	6.00	5.25	4.70
Socket	6.35	5.60	5.00

RN Cable Plugs

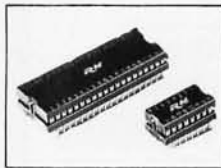

Pins	1-9	10-24	25-99	100
14	1.30	1.25	1.10	.95
16	1.50	1.40	1.25	1.10
24	2.25	2.15	2.00	1.75
40	3.75	3.50	3.25	2.95

- Provides pluggable termination of cable to PCB thru IDP plugs and standard DIP sockets such as RN ICN series DIP sockets.
- Single piece design for easy handling and assembly.
- Cover latch allows cover swivel for easy cable insertion.
- Tapered pin tip permits easy insertion into IC sockets.
- Strong leads for multiple insertions without damage.

RN Insulation Displacement Sockets

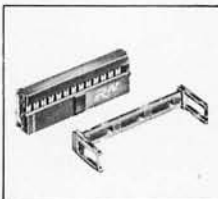

Pins	Socket Connector	1-9	10-24	25-99	Strain Relief
10	IDS10	1.40	1.20	1.10	.25
20	IDS20	2.00	1.85	1.75	.25
26	IDS26	2.50	2.40	2.30	.25
34	IDS34	3.25	3.10	2.95	.25
40	IDS40	3.95	3.70	3.55	.25
50	IDS50	5.00	4.60	4.40	.25

- Provides pluggable termination of cable to PCB thru IDS sockets and IDH headers.
- Single piece body construction for easy assembly, strain relief attached after assembly.
- Rugged cover latch and optional strain relief for dependability.
- Strain relief can be purchased separately.
- Molded orientation tab.

RN Transition Connectors

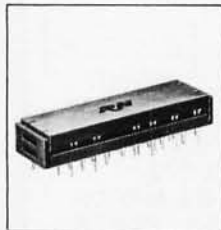

	1-9	10-24	25-99
10	1.50	1.35	1.25
20	1.75	1.60	1.50
26	2.25	2.00	1.75
34	2.50	2.40	2.30
40	3.00	2.80	2.60
50	3.60	3.45	3.15

- Connector used to permanently attach cable to PCB.
- Lead length options for .062" and .125" thick PCB.
- Rugged single piece design for easy assembly and dependability.
- Cable can be attached before or after soldering connector to PCB.

RN Cable

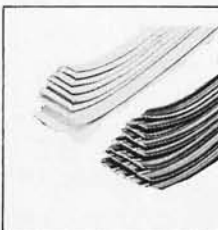

Conductors	Solid Color		Color Coded	
	10 ft.	100 ft.	10 ft.	100 ft.
10	2.90	17.00	4.00	30.00
14	3.40	23.80	5.00	42.00
16	3.70	27.20	5.60	48.00
20	4.40	34.00	7.00	60.00
24	5.00	40.80	8.00	72.00
26	5.40	44.20	8.60	78.00
34	6.80	57.80	11.00	102.00
40	7.80	68.00	13.00	120.00
50	9.50	85.00	16.00	150.00

- Compatible with all RN IDC products.
- Wire spacing .050" ± .002", 28 ga stranded.
- 10 thru 50 Conductor Laminated Cable Solid Color (with wire one mark) or Color Coded.
- Available in 100 foot rolls, or 10 foot lengths.
- Meets UL FR-1 Vertical Flame Test.

Note: Custom crimping available on all products for proto-type quantities at 50¢/connection.

Gold: All parts on this page except Cable are gold plated. Because of the volatility of gold pricing, orders may be subject to a gold surcharge.

135 EAST CHESTNUT STREET No. 5, MONROVIA, CALIFORNIA 91016 • (213) 357-5005 • TWX 910•585•3484

California Digital

Post Office Box 3097 B • Torrance, California 90503

FREE Paper Tiger

With Purchase of The INTEGRAL DATA 440
Your Choice, \$200 Value

- 1) Graphics Option Package
- 2) Interface for APPLE II
- 3) TRS-80 Printer Interface

California Digital has recently researched the complete low cost printer market. It is our opinion that the IDS-440 Paper Tiger is, without doubt, the most versatile and offers the best value of any printer costing under \$1,000.

This quality dot matrix printer incorporates such features as software selectable character size to allow print densities upto 132 characters per line. Full forms handling capabilities and tractor feed mechanism adjustable to 9.5". The Paper Tiger is engineered to accept either parallel or RS232 serial ASCII. 110/220V.50/60Hz.

***** \$995.00 plus shipping *****

S-100 Mother Board

Quiet Buss

The Quiet Buss from California Industrial is quality engineered. No short cuts have been taken to produce the mother board. Active termination circuitry prevents noise and crosstalk. Manufactured from extra heavy FR-4 epoxy glass.

\$2995
8803-18
18 slot
IMSAI

TELETYPE MODEL 43

4320 KEYBOARD

TTL AAA \$1050
RS232.... AAK 1150
Friction... AA 1100 plus shipping
103 Modem AAB 1575



Minidisk Drive for TRS-80

your choice **\$388.**

Lobo or Vista
Includes Interface Cable

FREE PLASTIC LIBRARY CASE with purchase of each box of ... Verbatim mini-diskettes. \$5 value.

\$24.95 BOX of 10
DISKETTES

CONNECTORS

your choice
DB25P male plug & hood
or
DB25S female

\$3.25

Qty. fe. male hd.
10 3.05 1.95 1.15
25 2.95 1.79 1.05
100 2.65 1.67 .95
500 2.25 1.60 .85
1K 1.97 1.37 .73

Edge Connectors

GOLD 100 PIN
IMSAI/ALTAIR

Im sai solder 125 x 250 \$2.95 3/4 7.50
Im sai w/w 125 centers \$4.95 3/4 13.00
Altair solder tail 140 row \$5.95 3/4 15.00

SPECIALS
22/44 Kim eyelet .156" \$1.95 3/4 5.00
25/50 solder tab .156" \$1.09 3/4 2.00
36/72 wide post w/w .156 \$1.95 3/4 5.00

SYSTEM X-10

It is not often that California Digital ventures into the distribution of consumer products, but we have recently come across a product that appears so unique that we just had to add it to our product line. This is the System X-10 manufactured by the IHS turntable company. This space age system will remotely control any light or appliance in your home or office. Command signals are transmitted from the command console over your existing wiring. From your hot or easy chair you can control up to 16 different electrical devices, television or any light fixture on the premises.

The model or system is available in the following components:
Ultrasonic Master Control Console \$34.95
Battery Operated Ultrasonic Controller 18.95
Appliance Module, Lamp Module or Wall Switch 13.95

SPECIAL APPLE II

16K MEMORY

COLOR • GRAPHICS • SOUND

\$988 Mfg. Sug. Retail... \$1195

PLUS SHIPPING

Authorized Distributor

Scotch Data Products

740-0	IBM soft format.	\$39.00	\$3.50
740-2	Double density soft	65.00	6.00
741-0	Double density	33.00	4.90
743-0	Double/D double	70.00	6.60
740-32	8" Hard sector	30.00	3.50
744-(0)10(16)	5 1/4" mini	39.00	3.50
Library case for any above; Add \$3.00			
834 A	Data Cassette	15.00	
D.C.100	Mini Cartridge	20.00	
D.C.300	Data Cartridge	20.00	
920 ()	Disk Cartridge	39.00	

Shugart Associates

SA800-R Floppy Disk Drive

The most cost effective way to store data processing information, when random recall is a prime factor. The SA800 is fully compatible with the IBM 3740 format. Write protect circuitry, low maintenance & Shugart quality.

\$449.50

XEROX 800 WORD PROCESSING KEYBOARD

ASCII ENCODED

This 77 key word processing keyboard was manufactured by Xerox specifically for use in the Xerox 800 word processing system. The keyboard outputs a seven bit ASCII code along with an eighth bit that allows most keys to shift and double function as special characters. Extra large "Tab & Return" keys are designed into the layout of the keyboard to simulate the IBM Selectric. 17 illuminated keys agree for special word processing codes. The keyboard is equipped with two thumbwheel switches for defining line width.

Original Xerox acquisition over \$400.00. California Digital USDID price only \$49.00. Excellent cond. Documentation included.

MEMORY

TRS-80 \$65
APPLE II 65

16k memory (8) 4116's

Installation is simple. Anyone who has ever changed a spark plug should be able to up-grade his microcomputer. How can California Digital offer these memory up-grade sets at 25% below our competition? Simple, we buy in volume, wholesale to dealers and sell the balance directly to owners of personal micro-systems. These 16K dynamic memory circuits are factory prime and unconditionally guaranteed for one full year. NOW, before you change your mind, pick up the telephone and order your up-grade memory from California Digital. Add \$3 for TRS80 jumpers.

STATIC

1-31	32-99	100-5C	999	1K+
211.02 450nS.	1.19	.99	.95	.90 .85
211.02 250nS.	1.49	1.39	1.25	*
2114 1Kx4 450	5.95	5.50	5.25	4.75 4.50
2114 1Kx4 300	8.95	8.50	8.00	*
4044 4Kx1 450	5.95	5.50	5.25	*
4044 4Kx1 250	9.95	9.50	9.00	*
4045 1Kx4 450	8.95	8.50	8.00	*
4045 1Kx4 250	9.95	9.50	9.00	*
5257 low pow.	5.95	5.50	5.00	4.80 4.60

SPECIAL CIRCUITS

Z80A 4MHz.	24.95	AY5-1013A UART	4.95
8080A CPU	9.95	Floppy Disc Controllers	
8085	22.50	WD 1771 single D.	39.95
8086 Intel 16 bits	85.00	WD 1781 Double D	65.00
FMS 8900 16 bits	49.95	WD 1791 1/D 3740	*

E PROMS

1702A	2K	4.95	4.50	4.00
2708	8K	9.95	9.50	9.00
2716 5v 16K		29.95	27.50	*
2716 T I		24.88	20.00	*
2532		85.00	*	*

TOUCH TONE® Speaker Phone

\$49
Factory Liquidation

The Voicecaster simply plugs into your existing phone wall jack. The twelve button pad creates standard Touch Tone frequencies. Unique electronic circuitry eliminates that hollow sound that you have heard on other systems.

Original retail price \$295. Please consult your local telephone company to determine if a line protection device is required in your community. Dial units also available.

ACOUSTIC MODEM

\$89
USED

The Chonice model 701 Modem connects the RS-232 serial port of your computer or peripheral device acoustically to your telephone line. Place the telephone handset into cradle of the modem, instantly your computer system has access to the world of digital information.

Half and full duplex ability.

PORTABLE DATA ENTRY SYSTEM

\$139.50

These used data terminals were originally designed for chain store inventory control and order entry systems. The operator enters the inventory control number, merchandise on hand and the unit price. After all pertinent data has been entered into the recorder, the main warehouse is telephoned, the handset is placed in the acoustic coupler and all the recorded information is transmitted back to the master computer. With a little imagination and one of these portable entry systems, you should be able to exchange program and computer information with associates across the country. All units were removed from service in working condition. Original cost \$2,300. Each system comes complete with:

- Portable Cassette Drive Unit
- Five Gould "D" NiCads
- Acoustical Coupler
- Battery Charger
- DB25 Cable
- Shoulder strap
- Full Documentation

Regent® 25

We have been asked not to advertise price. Please phone for discount.

Through years of research the ARES Corporation has evolved a low maintenance, extremely durable CRT terminal capable of withstanding an average 24 hour duty cycle. The Regent 25 features Intel 8085 microprocessor controlled circuitry along with the Cherry Switch long life capacitors keyboard, 18 key cursor and numeric pad displays to allow user customizable special functions. Five ascending lower case characters along with a fully adjustable cursor moves the Regent 25 the ideal word processing terminal.

High-resolution screen is capable of displaying 96 upper and lower case ASCII characters and 32 control codes. This terminal is switch selectable to display six European languages.

At \$599 (plus shipping) the Regent 25 offers the best value in today's CRT terminal market. Additional data upon request.

DISCOUNT Wire Wrap Center

IC SOCKETS

pin	Wire Wrap ea. 25 50	low profile ea. 25 50
8		17: 16 15
14	37: 36 35	18 17 16
16	38 37 36	19 18 17
24	99 93 85	36 35 34
40	169 155 139	63 60 58

50L **\$98** KYNAR WIRE WRAP

500 1,000 11,000
\$9. \$15. \$105.

Battery wire wrapping tool \$29.95

\$2995
BW 635

OK HOBBY WRAP-30 wire wrap 4 strip tool **\$545**



7400 TTL

SN7400N	.16	SN7400N	.29	SN74160N	.89
SN7401N	.18	SN7401N	.35	SN74161N	.89
SN7402N	.18	SN7402N	.49	SN74162N	1.95
SN7403N	.18	SN7403N	.50	SN74163N	.89
SN7404N	.18	SN7404N	5.00	SN74164N	.89
SN7405N	.20	SN7405N	.50	SN74165N	.89
SN7406N	.29	SN7406N	.99	SN74166N	1.25
SN7407N	.29	SN7407N	.99	SN74167N	1.95
SN7408N	.20	SN7408N	.79	SN74170N	1.59
SN7409N	.20	SN7409N	.35	SN74171N	1.25
SN7410N	.18	SN7409N	1.75	SN74172N	1.00
SN7411N	.25	SN7410N	.45	SN74174N	.89
SN7412N	.25	SN7411N	.59	SN74175N	.79
SN7413N	.40	SN7412N	.49	SN74176N	.79
SN7414N	.70	SN7413N	.43	SN74177N	.79
SN7416N	.25	SN7414N	.65	SN74179N	1.95
SN7417N	.25	SN7415N	.65	SN74180N	.79
SN7420N	.20	SN7416N	.65	SN74181N	1.95
SN7421N	.29	SN7417N	3.00	SN74182N	.79
SN7422N	.39	SN7418N	.39	SN74184N	1.95
SN7423N	.25	SN7419N	.35	SN74185N	1.95
SN7425N	.29	SN7420N	.99	SN74186N	9.95
SN7426N	.29	SN7421N	1.95	SN74188N	3.95
SN7427N	.25	SN7422N	.35	SN74190N	1.25
SN7429N	.39	SN7423N	.49	SN74191N	1.25
SN7430N	.29	SN7424N	.49	SN74192N	.79
SN7432N	.25	SN7425N	.49	SN74193N	.79
SN7433N	.25	SN7426N	.25	SN74194N	.89
SN7434N	.25	SN7427N	.75	SN74195N	.69
SN7435N	.25	SN7428N	.75	SN74196N	.89
SN7436N	.25	SN7429N	.75	SN74197N	.89
SN7437N	.25	SN7430N	.75	SN74198N	1.49
SN7438N	.25	SN7431N	.75	SN74199N	1.49
SN7439N	.25	SN7432N	.75	SN74200N	4.95
SN7440N	.25	SN7433N	.75	SN74201N	.99
SN7441N	.39	SN7434N	.75	SN74202N	.99
SN7442N	.49	SN7435N	.75	SN74203N	.99
SN7443N	.75	SN7436N	.75	SN74204N	.99
SN7444N	.75	SN7437N	.75	SN74205N	.99
SN7445N	.75	SN7438N	.75	SN74206N	.99
SN7446N	.75	SN7439N	.75	SN74207N	.99
SN7447N	.75	SN7440N	.75	SN74208N	.99
SN7448N	.75	SN7441N	.75	SN74209N	.99
SN7449N	.75	SN7442N	.75	SN74210N	.99
SN7450N	.75	SN7443N	.75	SN74211N	.99
SN7451N	.75	SN7444N	.75	SN74212N	.99
SN7452N	.75	SN7445N	.75	SN74213N	.99
SN7453N	.75	SN7446N	.75	SN74214N	.99
SN7454N	.75	SN7447N	.75	SN74215N	.99
SN7455A	.25	SN7448N	.75	SN74216N	.99
SN7456N	.25	SN7449N	.75	SN74217N	.99
		SN7450N	.75	SN74218N	.99
		SN7451N	.75	SN74219N	.99
		SN7452N	.75	SN74220N	.99
		SN7453N	.75	SN74221N	.99
		SN7454N	.75	SN74222N	.99
		SN7455N	.75	SN74223N	.99
		SN7456N	.75	SN74224N	.99



8K Bytesaver II

Memory Capacity: 8K bytes
Memory Type: 2708 PROM or equivalent
Memory Access Time: 450 nanoseconds
Wait States at 4MHz: none required
Wait States at 4MHz: one per machine cycle
Bus: S-100
Power Requirements: +8V @ 0.8A
+18V @ 0.4A
-18V @ 0.2A
Operating Environment: 0-55°C

Cromemco's 8K BYTESAVER® card provides a built-in programmer for the popular 2708 PROM and has the capacity for a full 8K bytes of PROM memory storage. The BYTESAVER® II also offers a number of new features including convenient switch selection of board address and Cromemco's powerful memory bank selection. The BYTESAVER® II is assembled and tested (Model 8KBS-W) for \$245.

Assembled 8KBS-W... \$245.00

DISCRETE LEADS

XC556R	red	5/S1	.125" dia.	XC209R	red	5/S1
XC556G	green	4/S1		XC209G	green	4/S1
XC556Y	yellow	4/S1		XC209Y	yellow	4/S1
XC556C	clear	4/S1				
XC22R	red	5/S1	.185" dia.	XC526R	red	4/S1
XC22G	green	4/S1		XC526G	green	4/S1
XC22Y	yellow	4/S1		XC526C	clear	4/S1
CV10B	red	4/S1	.170" dia.			
CV10C	red	4/S1				
CV10D	red	4/S1				
CV10E	red	4/S1				
CV10F	red	4/S1				
CV10G	red	4/S1				
CV10H	red	4/S1				
CV10I	red	4/S1				
CV10J	red	4/S1				
CV10K	red	4/S1				
CV10L	red	4/S1				
CV10M	red	4/S1				
CV10N	red	4/S1				
CV10O	red	4/S1				
CV10P	red	4/S1				
CV10Q	red	4/S1				
CV10R	red	4/S1				
CV10S	red	4/S1				
CV10T	red	4/S1				
CV10U	red	4/S1				
CV10V	red	4/S1				
CV10W	red	4/S1				
CV10X	red	4/S1				
CV10Y	red	4/S1				
CV10Z	red	4/S1				

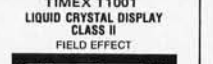

TIMEX T1001
LIQUID CRYSTAL DISPLAY
CLASS II
FIELD EFFECT
4 DIGIT - 5" CHARACTERS
THREE INDICATORS
2.00" X 1.20" PACKAGE
INCLUDES CONNECTOR
T1001-Transmissive \$7.95
T1001A-Reflective 8.25

DISPLAY LEADS

TYPE	POLARITY	HT	PRICE	TYPE	POLARITY	HT	PRICE
MAN 1	Common Anode-red	270	2.55	MAN 6730	Common Anode-red ± 1	560	.99
MAN 2	5 x 7 Dot Matrix-red	300	4.55	MAN 6740	Common Cathode-red-D.D.	560	.99
MAN 3	Common Cathode-red	125	.25	MAN 6750	Common Cathode-red ± 1	560	.99
MAN 4	Common Cathode-red	187	1.85	MAN 6760	Common Cathode-red	560	.99
MAN 5	Common Anode-green	300	1.25	MAN 6780	Common Cathode-red	560	.99
MAN 6	Common Anode-yellow	300	.99	DL701	Common Anode-red ± 1	300	.99
MAN 7	Common Anode-red	300	.75	DL702	Common Cathode-red	300	.99
MAN 7A	Common Cathode-red	300	1.25	DL703	Common Cathode-red	300	.99
MAN 7B	Common Cathode-red	300	.49	DL704	Common Cathode-red	300	.99
MAN 7C	Common Cathode-red	300	.49	DL705	Common Cathode-red	300	.99
MAN 7D	Common Cathode-red	300	.49	DL706	Common Cathode-red	300	.99
MAN 7E	Common Cathode-red	300	.49	DL707	Common Cathode-red	300	.99
MAN 7F	Common Cathode-red	300	.49	DL708	Common Cathode-red	300	.99
MAN 7G	Common Cathode-red	300	.49	DL709	Common Cathode-red	300	.99
MAN 7H	Common Cathode-red	300	.49	DL710	Common Cathode-red	300	.99
MAN 7I	Common Cathode-red	300	.49	DL711	Common Cathode-red	300	.99
MAN 7J	Common Cathode-red	300	.49	DL712	Common Cathode-red	300	.99
MAN 7K	Common Cathode-red	300	.49	DL713	Common Cathode-red	300	.99
MAN 7L	Common Cathode-red	300	.49	DL714	Common Cathode-red	300	.99
MAN 7M	Common Cathode-red	300	.49	DL715	Common Cathode-red	300	.99
MAN 7N	Common Cathode-red	300	.49	DL716	Common Cathode-red	300	.99
MAN 7O	Common Cathode-red	300	.49	DL717	Common Cathode-red	300	.99
MAN 7P	Common Cathode-red	300	.49	DL718	Common Cathode-red	300	.99
MAN 7Q	Common Cathode-red	300	.49	DL719	Common Cathode-red	300	.99
MAN 7R	Common Cathode-red	300	.49	DL720	Common Cathode-red	300	.99
MAN 7S	Common Cathode-red	300	.49	DL721	Common Cathode-red	300	.99
MAN 7T	Common Cathode-red	300	.49	DL722	Common Cathode-red	300	.99
MAN 7U	Common Cathode-red	300	.49	DL723	Common Cathode-red	300	.99
MAN 7V	Common Cathode-red	300	.49	DL724	Common Cathode-red	300	.99
MAN 7W	Common Cathode-red	300	.49	DL725	Common Cathode-red	300	.99
MAN 7X	Common Cathode-red	300	.49	DL726	Common Cathode-red	300	.99
MAN 7Y	Common Cathode-red	300	.49	DL727	Common Cathode-red	300	.99
MAN 7Z	Common Cathode-red	300	.49	DL728	Common Cathode-red	300	.99

C/MOS

CD4000	.23	CD4070	.55
CD4001	.23	CD4071	.23
CD4002	.23	CD4072	.49
CD4003	1.19	CD4073	1.82
CD4004	.25	CD4074	.23
CD4005	.25	CD4075	.23
CD4006	.25	CD4076	.23
CD4007	.25	CD4077	.23
CD4008	.25	CD4078	.23
CD4009	.25	CD4079	.23
CD4010	.25	CD4080	.23
CD4011	.25	CD4081	.23
CD4012	.25	CD4082	.23
CD4013	.25	CD4083	.23
CD4014	1.39	CD4084	.89
CD4015	1.19	CD4085	.89
CD4016	1.19	CD4086	.89
CD4017	1.19	CD4087	.89
CD4018	1.19	CD4088	.89
CD4019	1.19	CD4089	.89
CD4020	1.19	CD4090	.89
CD4021	1.19	CD4091	.89
CD4022	1.19	CD4092	.89
CD4023	1.19	CD4093	.89
CD4024	1.19	CD4094	.89
CD4025	1.19	CD4095	.89
CD4026	1.19	CD4096	.89
CD4027	1.19	CD4097	.89

74C00

74C00	.39	74C163	2.49
74C01	.39	74C164	2.49
74C02	.39	74C165	2.49
74C03	.39	74C166	2.49
74C04	.39	74C167	2.49
74C05	.39	74C168	2.49
74C06	.39	74C169	2.49
74C07	.39	74C170	2.49
74C08	.39	74C171	2.49
74C09	.39	74C172	2.49
74C10	.39	74C173	2.49
74C11	.39	74C174	2.49
74C12	.39	74C175	2.49
74C13	.39	74C176	2.49
74C14	.39	74C177	2.49
74C15	.39	74C178	2.49
74C16	.39	74C179	2.49
74C17	.39	74C180	2.49
74C18	.39	74C181	2.49
74C19	.39	74C182	2.49
74C20	.39	74C183	2.49
74C21	.39	74C184	2.49
74C22	.39	74C185	2.49
74C23	.39	74C186	2.49
74C24	.39	74C187	2.49
74C25	.39	74C188	2.49
74C26	.39	74C189	2.49
74C27	.39	74C190	2.49
74C28	.39	74C191	2.49
74C29	.39	74C192	2.49
74C30	.39	74C193	2.49
74C31	.39	74C194	2.49
74C32	.39	74C195	2.49
74C33	.39	74C196	2.49
74C34	.39	74C197	2.49
74C35	.39	74C198	2.49
74C36	.39	74C199	2.49
74C37	.39	74C200	2.49
74C38	.39	74C201	2.49
74C39	.39	74C202	2.49
74C40	.39	74C203	2.49
74C41	.39	74C204	2.49
74C42	.39	74C205	2.49
74C43	.39	74C206	2.49
74C44	.39	74C207	2.49
74C45	.39	74C208	2.49
74C46	.39	74C209	2.49
74C47	.39	74C210	2.49
74C48	.39	74C211	2.49
74C49	.39	74C212	2.49
74C50	.39	74C213	2.49

74C00

74C00	.39	74C163	2.49
74C01	.39	74C164	2.49
74C02	.39	74C165	2.49
74C03	.39	74C166	2.49
74C04	.39	74C167	2.49
74C05	.39	74C168	2.49
74C06	.39	74C169	2.49
74C07	.39	74C170	2.49
74C08	.39	74C171	2.49
74C09	.39	74C172	2.49
74C10	.39	74C173	2.49
74C11	.39	74C174	2.49
74C12	.39	74C175	2.49
74C13	.39	74C176	2.49

Continuity Tester and Flashlight



Convenient versatile tool for quickly checking continuity of dead circuits, switches, appliances, cords, fuses, motors, control equipment, coils and panel boards. Also tests circuits for low-resistance shorts and helps identify wires in multi-wire cables. Dozens of other uses. Plus the added convenience of a handy, durable flashlight. Uses two AA size penlight batteries (not furnished). Insulated clip prevents accidental shorting to case. Alligator clip has 48" lead with plug.

RT300 **\$7.95**

CONTINENTAL SPECIALTIES

Logic Monitor



The Logic Monitor allows you to check logic levels on all 16 pins of any DTL, TTL, or CMOS device. It has a typical input impedance of 100K ohms and weighs a mere 3 oz. (85 grams). It has an input voltage range of 4V to 15V and draws a max. of 100mA@10V

LM-1 **\$70.00**

Proto Clips



14-PIN CLIP	PC-14	\$ 4.50
16-PIN CLIP	PC-16	\$ 4.75
24-PIN CLIP	PC-24	\$10.00
40-PIN CLIP	PC-40	\$16.00

Proto Boards



PB-6	\$17.95
PB-100	19.95
PB-101	22.95
PB-102	26.95
PB-103	44.95
PB-104	55.95
PB-203	99.95
PB-203A	155.00
PB-203A-Kit	131.00

Jumbo 6-Digit Clock Kit

- Four .630"ht. and two .300"ht. common anode displays
- Uses MM5314 clock chip
- Switches for hours, minutes and hold functions
- Hours easily viewable to 30 feet
- Simulated walnut case
- 115 VAC operation
- 12 or 24 hour operation
- Includes all components, case and wall transformer
- Size: 6 1/4" x 3 1/4" x 1 1/4"

JE747 **\$29.95**

JE701

- Bright .300 ht. comm. cathode display
- Uses MM5314 clock chip
- Switches for hours, minutes and hold modes
- Hrs. easily viewable to 20 ft.
- Simulated walnut case
- 115 VAC operation
- 12 or 24 hr. operation
- Incl. all components, case & wall transformer
- Size: 6 1/4" x 3 1/8" x 1 1/4"

6-Digit Clock Kit **\$19.95**

Regulated Power Supply

Uses LM309K. Heat sink provided. PC board construction. Provides a solid 1 amp @ 5 volts. Can supply up to ±5V, ±9V and ±12V with JE205 Adapter. Includes components, hardware and instructions. Size: 3 1/2" x 5" x 2 1/2"

JE200 **\$14.95**

ADAPTER BOARD

—Adapts to JE200—
±5V, ±9V and ±12V



DC/DC converter with +5V input. Toroidal hi-speed switching XMFR. Short circuit protection. PC board construction. Piggy-back to JE 200 board. Size: 3 1/2" x 2" x 9/16" H

JE205 **\$12.95**

MICROPROCESSOR COMPONENTS

8080A/8080A SUPPORT DEVICES		MICROPROCESSOR MANUALS		
8080A	CPU	M-280	User Manual	\$7.50
8212	8-Bit Input/Output	M-CDP1802	User Manual	7.50
8214	Priority Interrupt Control	M-7650	User Manual	5.00
8216	Bi-Directional Bus Driver			
8224	Clock Generator/Driver			
8226	Bus Driver			
8228	System Controller/Bus Driver			
8238	System Controller/Bus Driver			
8251	Prog. Comm. I/O (USART)	2513(2140)	Character Generator(upper case)	\$9.95
8253	Prog. Interval Timer	2513(3021)	Character Generator(lower case)	9.95
8255	Prog. Periph. I/O (PPI)	2516	Character Generator	10.95
8257	Prog. DMA Control	MMS5320N	2048-Bit Read Only Memory	1.95
8259	Prog. Interrupt Control			
8080/8080A SUPPORT DEVICES		ROM'S		
MC6800	MPU with Clock and Ram	2192	1024X1 Static	1.75
MC6810A	128X8 Static Ram	2102	1024X1 Static	1.95
MC6821	Periph. Inter. Adap. (MC6820)	2111(8111)	256X4 Static	3.95
MC6828	Priority Interrupt Controller	2112	256X4 Static MOS	4.95
MC6830L8	1024X8 Bit ROM (MC6830-8)	2114	1024X4 Static 450ns	7.95
MC6850	Asynchronous Comm. Adapter	2143	1024X4 Static 450ns low power	10.95
MC6852	Synchronous Serial Data Adapter	2144-3	1024X4 Static 300ns low power	11.95
MC6860	0-600 bps Digital MODEM	5101	256X4 Static	7.95
MC6862	2400 bps Modulator	5280/2107	4096X1 Dynamic	4.95
MC6880A	Dual 3-State Bus Trans. (MC6826)	7489	16K Static	1.75
MICROPROCESSOR CHIPS—MISCELLANEOUS		745200	256X1 Static Tristate	4.95
Z801780C1	CPU	5101	256X4 Static	7.95
Z80A1780-1	CPU	UP0414	4K Dynamic 16 pin	4.95
CDP1802	CPU	UP0416	16K Dynamic 16 pin 250ns	9.95
2650	MPU	UP0416	16K Dynamic 16 pin 250ns	9.95
6502	CPU	(MK4116)	4K Static	14.95
8035	8-Bit MPU w/clock, RAM, I/O lines	TMS4044	4K Static	14.95
P8085	CPU	45N1	4K Static	14.95
TMS9900L	16-Bit MPU/hardware, multiply & divide	TMS4045	1024X4 Static Dynamic 350ns (house marked)	14.95
		2117	16,384X1 Dynamic	9.95
		MMS262	2KX1 Dynamic	4/1.00
SHIFT REGISTERS		PROM'S		
MM500H	Dual 25 Bit Dynamic	1782A	2048 FAMOS	\$5.95
MM503H	Dual 50 Bit Dynamic	2716INTEL	16K* EPROM	59.95
MM504H	Dual 16 Bit Static	MMS2516	16K* EPROM	49.95
MM506H	Dual 100 Bit Static	(2716)	*Requires single +5V power supply	
MM510H	Dual 64 Bit Accumulator	2716	16K* EPROM	89.95
MM510H	500/512 Bit Dynamic	2708	8K* EPROM	10.95
2504T	1024 Dynamic	2716 T.1	16K* EPROM	29.95
2518	Hex 32 Bit Static			
2522	Dual 132 Bit Static			
2524	512 Static			
2525	1024 Dynamic			
2527	Dual 256 Bit Static			
2528	Dual 250 Static			
2529	Dual 240 Bit Static			
2532	Dual 80 Bit Static			
3341	File			
74LS670	4X4 Register File (TriState)			
UART'S				
A-Y-5-1013	30K BAUD			

JE600 HEXADECIMAL ENCODER KIT

FEATURES:

- Full 8 bit latched output for micro-processor use
- 3 User Define keys with one being bistable operation
- Debounce circuit provided for all 19 keys
- LED readout to verify entries
- Easy interfacing with standard 16 pin IC connector
- Only +5VDC required for operation

FULL 8 BIT LATCHED OUTPUT—19 KEYBOARD

The JE600 Encoder Keyboard provides two separate hexadecimal digits produced from sequential key entries to allow direct programming for 8 bit microprocessors or 8 bit memory circuits. Three (3) additional keys are provided for user operations with one having a bistable output available. The outputs are latched and monitored with LED readouts. Also included is a key entry strobe.

JE600 **\$59.95**
Hexadecimal Keypad only **\$14.95**

DIGITAL THERMOMETER KIT



• Dual sensors—switching control for indoor/outdoor or dual monitoring

• Continuous LED 8" ht. display

• Range: -40°F to 199°F / -40°C to 100°C

• Accuracy: ±1° nominal

• Set for Fahrenheit or Celsius reading

• Sim. walnut case - AC wall adapter incl.

• Size: 3-1/4" H x 6-5/8" W x 1-3/8" D

JE300 **\$39.95**

62-Key ASCII Encoded Keyboard Kit

FEATURES:

- 60 Keys generate the full 128 characters, upper and lower case ASCII set
- Fully buffered
- 2 user define keys provided for custom applications
- Caps lock for upper case only alpha characters
- Utilizes a 2376 (40 pin) encoder read only memory chip
- Outputs directly compatible with TTL, DTL or MOS logic arrays
- Easy interfacing with a 16-pin dip or 18-pin edge connector

JE610 **\$79.95**
62-Key Keyboard only .. **\$34.95**

JE610

The JE610 62-Key ASCII Encoded Keyboard Kit can be interfaced into most any computer system. The JE610 Kit comes complete with an industrial grade keyboard switch assembly (62 keys), IC's, sockets, connector, electronic components and a double-sided printed wiring board. The keyboard assembly requires +5V @ 150mA and -12V @ 10mA for operation.

HICKOK LX303 Portable LCD Digital Multimeter

- Big 1 1/2 inch high 3 1/2" Digit Liquid Crystal Display
- Over 200 Hours of operation with a 9V battery
- Automatic zero polarity and overrange indication
- 1000V DC F.S. sensitivity
- 1% basic accuracy
- 19 ranges and functions
- Rugged Cyclastic case and removable cover, stores test lead set.
- Full one year warranty.

SPECIFICATIONS: DC volts 10 range 0 to 1000V, Accuracy: ±0.5% rdg ±0.5% fs. Input imped. 10MΩ. Max. input 15V resist 200V on 2000V range. AC Volts 100V to 500V, 0 to 600V, Accuracy: ±1.0% rdg ±0.5% fs. 1.20M max. @ 50Hz. Max. input 800V Resistance 10 Low Power Range 0.1 to 20MΩ. Accuracy: ±0.5% rdg ±0.5% fs. 1.11 MΩ rdg on 20MΩ range. Max. current on 100V AC range 100mA. DC Current 10 range 0.1 to 1000A, Accuracy: ±1.0% rdg ±0.5% fs. Dimensions and Weight: 9 1/2" x 3 1/2" x 3 1/2". Net. 900g. 9V battery (not included) or Hickok AC Adapter. READ RATE 3/sec.

LX303	Digital Multimeter	\$74.95
PART NO.	DESCRIPTION		PRICE
RC-3	115V AC ADAPTER	7.50
CC-3	PADDLED CARRYING CASE	7.50
VP-10	X10 DC PROBE ADAPTER (Up to 10K)	14.95
VP-40	40kV DC PROBE	35.00
CS-1	10 Amp DC Current Shunt	14.95

\$10.00 Min. Order — U.S. Funds Only
Calif. Residents Add 6% Sales Tax
Postage — Add 5% plus \$1 Insurance (if desired)

Spec Sheets — 25¢
1980 Catalog Available — Send 41¢ stamp

Jameco ELECTRONICS

PHONE ORDERS WELCOME
(415) 592-8097

MAIL ORDER ELECTRONICS — WORLDWIDE
1355 SHOREWAY ROAD, BELMONT, CA 94002
ADVERTISED PRICES GOOD THRU MARCH

The Incredible "Pennywhistle 103"



\$139.95 Kit Only

The Pennywhistle 103 is capable of recording data to and from audio tape without critical speed requirements for the recorder and it is able to communicate directly with another modem and terminal for telephone "hamming" and communications. In addition, it is free of critical adjustments and is built with non-precision, readily available parts.

Data Transmission Method Frequency-Shift Keying, full-duplex (half-duplex selectable)

Maximum Data Rate 300 Baud.

Data Format Asynchronous Serial (return to mark level required between each character)

Receive Channel Frequencies 2025 Hz for space; 2225 Hz for mark

Transmit Channel Frequencies Switch selectable Low (normal) — 1070 space, 1270 mark; High — 025 space, 2225 mark.

Receive Sensitivity 46 dbm acoustically coupled

Transmit Level 15 dbm nominal. Adjustable from -6 dbm to -20 dbm.

Receive Frequency Tolerance Frequency reference automatically adjusts to allow for operation between 1800 Hz and 2400 Hz

Digital Data Interface EIA RS-232C or 20 mA current loop (receiver is optoisolated and non-polar)

Power Requirements 120 VAC, single phase, 10 Watts

Physical All components mount on a single 5" by 9" printed circuit board. All components included.

Requires a VOM, Audio Oscillator, Frequency Counter and/or Oscilloscope to align.

TRS-80 16K Conversion Kit

Expand your 4K TRS-80 System to 16K.

Kit comes complete with:

- 8 each UPD416-1 (16K Dynamic Rams) 250NS
- Documentation for conversion

TRS-16K **\$75.00**

JUST WRAP™



- 30 AWG wire
- .025" square posts
- Daisy chain or point-to-point
- Built-in cut off
- Includes 50 ft. wire
- No stripping or slitting required—just wrap

Part No.	Wire Color	Price
JW-1-B	Blue	\$14.95
JW-1-W	White	14.95
JW-1-Y	Yellow	14.95
JW-1-R	Red	14.95

JUST WRAP™ Replacement Wire

Part No.	Color	Price
R-JW-B	Blue	50 ft. roll \$2.98
R-JW-W	White	50 ft. roll 2.98
R-JW-Y	Yellow	50 ft. roll 2.98
R-JW-R	Red	50 ft. roll 2.98

JUST WRAP™ Unwrap Tool \$3.49



VV-1 **\$3.49**

ADJUSTABLE WRENCH



- Two Sizes: 6" and 10"
- Professional Quality
- Chrome Vanadium Steel

6" — AW-6 .. **\$4.95** 10" — AW-10 .. **\$6.95**

JOYSTICK VIDEO CONTROLLER



• IDEAL FOR ALL VIDEO GAMES OR REMOTE CONTROL PROJECTS

• SMALL CASE SIZE: 1-1/2" H x 2-3/8" W x 4-5/16" L

• 2 MINIATURE POTENTIOMETERS—40K OHM EACH

• SPST PUSH BUTTON CONTROL

• 5-WIRE CONNECTION CABLE — 5 FEET LONG

• RUGGED PLASTIC CASE

JVC-40 **\$4.95 each**

TRS-80 E.S. SERIAL I/O

- Can input into basic
- Can use LLIST and LPRINT to output, or output continuously
- RS-232 compatible
- Can be used with or without the expansion bus
- On board switch selectable baud rates of 110, 150, 300, 600, 1200, 2400, parity or no parity odd or even, 5 to 8 data bits, and 1 or 2 stop bits. D.T.R. line
- Requires +5, -12 VDC
- Board only \$19.95 Part No. 8010, with parts \$59.95 Part No. 8010A, assembled \$79.95 Part No. 8010 C. No connectors provided, see below.

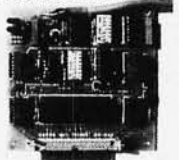

EIA/RS-232 connector Part No. DB25P \$6.00, with 9', 8 conductor cable \$10.95 Part No. DB25P9.



3' ribbon cable with attached connectors to fit TRS-80 and our serial board \$19.95 Part No. 3CAB40.

MODEM

- Type 103
- Full or half duplex
- Works up to 300 baud
- Originate or Answer
- No coils, only low cost components
- TTL input and output-serial
- Connect 8 Ω speaker and crystal mic. directly to board
- Uses XR FSK demodulator
- Requires +5 volts
- Board only \$7.60 Part No. 109, with parts \$29.95 Part No. 109A

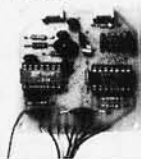

DISKETTES



Box of 10, 5" \$29.95, 8" \$39.95. Plastic box, holds 10 diskettes, 5" - \$4.50, 8" - \$6.50.

APPLE II** SERIAL I/O INTERFACE

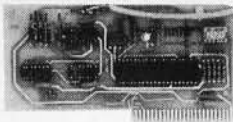

Baud rate is continuously adjustable from 0 to 30,000

- Plugs into any peripheral connector
- Low current drain. RS-232 input and output
- On board switch selectable 5 to 8 data bits, 1 or 2 stop bits, and parity or no parity either odd or even
- Jumper selectable address
- SOFTWARE
- Input and Output routine from monitor or BASIC to teletype or other serial printer
- Program for using an Apple II for a video or an intelligent terminal.
- Also can output in correspondence code to interface with some selectrics.
- Also watches DTR
- Board only \$15.00 Part No. 2, with parts \$42.00 Part No. 2A, assembled \$62.00 Part No. 2C

8K EPROM PIGEON

Saves programs on PROM permanently (until erased via UV light) up to 8K bytes. Programs may be directly run from the program saver such as fixed routines or assemblers.

- S-100 bus compatible
- Room for 8K bytes of EPROM non-volatile memory (2708's).
- On-board PROM programming
- Address relocation of each 4K of memory to any 4K boundary within 64K
- Power on jump and reset jump option for "turnkey" systems and computers without a front panel
- Program saver software available
- Solder mask both sides
- Full silkscreen for easy assembly.
- Program saver software in 1 2708 EPROM \$25. Bare board \$35 including custom coil, board with parts but no EPROMS \$139, with 4 EPROMS \$179, with 8 EPROMS \$219.

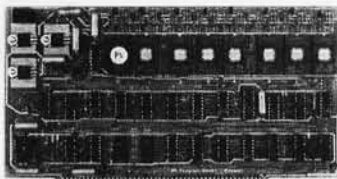

WAMECO PRODUCTS WITH

ELECTRONIC SYSTEMS PARTS

FDC-1 FLOPPY CONTROLLER BOARD will drive shugart, pertek, remex 5" & 8" drives up to 8 drives, on board PROM with power boot up, will operate with CPM (not included). PCBD \$42.95

FPB-1 Front Panel. (Finally) IMSAI size hex displays. Byte or instruction single step. PCBD \$42.95

MEM-1A 8Kx8 fully buffered, S-100, uses 2102 type RAMS. PCBD \$24.95, \$168 Kit

GMB-12 MOTHER BOARD, 13 slot, terminated, S-100 board only \$34.95, \$89.95 Kit

CPU-1 8080A Processor board S-100 with 8 level vector interrupt PCBD .. \$25.95, \$89.95 Kit

RTC-1 Realtime clock board. Two independent interrupts. Software programmable. PCBD \$25.95, \$60.95 Kit

EPM-1 1702A 4K EPROM card PCBD \$25.95, \$49.95 with parts less EPROMS

EPM-2 2708/2716 16K/32K EPROM card PCBD \$24.95, \$49.95 with parts less EPROMS

GMB-9 MOTHER BOARD. Short Version of GMB-12. 9 Slots PCBD \$30.95, \$67.95 Kit

MEM-2 16Kx8 Fully Buffered 2114 Board PCBD \$25.95, \$269.95 Kit

T.V. TYPEWRITER

- Stand alone TVT
- 32 char/line, 16 lines, modifications for 64 char/line included
- Parallel ASCII (TTL) input
- Video output
- 1K on board memory
- Output for computer controlled cursor
- Auto scroll
- Non-destructive cursor
- Cursor inputs: up, down, left, right, home, EOL, EOS
- Scroll up, down
- Requires +5 volts at 1.5 amps, and -12 volts at 30 mA
- All 7400, TTL chips
- Char. gen. 2513
- Upper case only
- Board only \$39.00 Part No. 106, with parts \$145.00 Part No. 106A



UART & BAUD RATE GENERATOR

- Converts serial to parallel and parallel to serial
- Low cost on board baud rate generator
- Baud rates: 110, 150, 300, 600, 1200, and 2400
- Low power drain +5 volts and -12 volts required
- TTL compatible
- All characters contain a start bit, 5 to 8 data bits, 1 or 2 stop bits, and either odd or even parity.
- All connections go to a 44 pin gold plated edge connector
- Board only \$12.00 Part No. 101, with parts \$35.00 Part No. 101A, 44 pin edge connector \$4.00 Part No. 44P

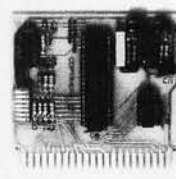

TAPE INTERFACE

- Play and record Kansas City Standard tapes
- Converts a low cost tape recorder to a digital recorder
- Works up to 1200 baud
- Digital in and out are TTL-serial
- Output of board connects to mic. in of recorder
- Earphone of recorder connects to input on board
- No coils
- Requires +5 volts, low power drain
- Board only \$7.60 Part No. 111, with parts \$29.95 Part No. 111A

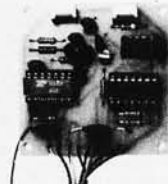

HEX ENCODED KEYBOARD

E.S.
This HEX keyboard has 19 keys, 16 encoded with 3 user definable. The encoded TTL outputs, 8-4-2-1 and STROBE are debounced and available in true and complement form. Four onboard LEDs indicate the HEX code generated for each key depression. The board requires a single +5 volt supply. Board only \$15.00 Part No. HEX-3, with parts \$49.95 Part No. HEX-3A. 44 pin edge connector \$4.00 Part No. 44P.

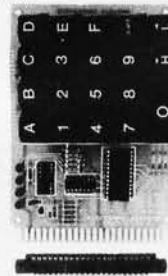

RS-232/ TTL INTERFACE

- Converts TTL to RS-232, and converts RS-232 to TTL
- Two separate circuits
- Requires -12 and +12 volts
- All connections go to a 10 pin gold plated edge connector, kit \$ 9.95 Part No. 232A 10 Pin edge connector \$3.00 Part No. 10P.

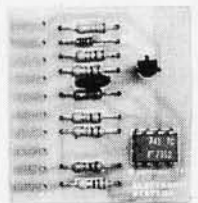

RS-232/TTY INTERFACE

This board has two active circuits, one converts RS-232 to 20mA, and the other converts 20mA to RS-232. Requires +12 and -12 volts. \$9.95 Part No. 600A Kit.

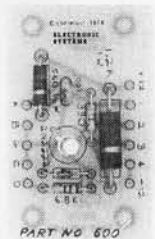

S-100 BUS ACTIVE TERMINATOR

Board only \$14.95 Part No. 900, with parts \$24.95 Part No. 900A

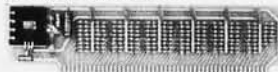

DC POWER SUPPLY

- Board supplies a regulated +5 volts at 3 amps., +12, -12, and -5 volts at 1 amp.
- Power required is 8 volts AC at 3 amps., and 24 volts AC C.T. at 1.5 amps.
- Board only \$12.50 Part No. 6085, with parts excluding transformers \$42.50 Part No. 6085A



To Order: Mention part no. description, and price. In USA shipping paid by us for orders accompanied by check or money order. We accept C.O.D. orders in the U.S. only, or a VISA or Master Charge no., expiration date, signature, phone no., shipping charges will be added. CA residents add 6.5% for tax. Outside USA add 10% for air mail postage and handling. Payment must be in U.S. dollars. Dealer inquiries invited. 24 hour order line (408) 448-0800



Send for FREE Catalog . . . a big self-addressed envelope with 41¢ postage gets it fastest!

ELECTRONIC SYSTEMS Dept. B P. O. Box 21638, San Jose, CA USA 95151

COMPUCRUISE

Put a computer in your car, which gives you the most effective and functional cruise control ever designed, plus complete trip computing, fuel management systems, and a remarkable accurate quartz crystal time system.

So simple a child can operate, the new CompuCruise combines latest computer technology with state-of-the-art reliability in a package which will not likely be available on new cars for years to come.

- Cruise Control
- Time, E.T., Lap Timer, Alarm
- Time, Distance, Fuel to Arrival
- Time, Distance, Fuel to Empty
- Time, Distance and Fuel on Trip
- Current or Average MPG, GPH
- Fuel Used, Distance since Fillup
- Current and Average Vehicle Speed
- Inside, Outside or Coolant Temperature
- Battery Voltage
- English or Metric Display.

\$169.95, without cruise control \$129.95.



FLOPPY DISK STORAGE BINDER

This black vinyl three-ring binder comes with ten transparent plastic sleeves which accommodate either twenty, five-inch or ten, eight-inch floppy disks. The plastic sleeves may be ordered separately and added as needed. A contents file is included with each sleeve for easy identification and organizing. Binder & 10 holders \$14.95 Part No. B800; Extra holders 95¢ each. Part No. 800



OPTO-ISOLATED PARALLEL INPUT BOARD FOR APPLE II

There are 8 inputs that can be driven from TTL logic or any 5 volt source. The circuit board can be plugged into any of the 8 sockets of your Apple II. It has a 16 pin socket for standard dip ribbon cable connection. Board only \$15.00. Part No. 120, with parts \$69.95. Part No. 120A.

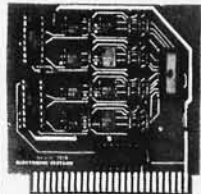

TIDMA

- Tape Interface Direct Memory Access
- Record and play programs without bootstrap loader (no prom) has FSK encoder/decoder for direct connections to low cost recorder at 1200 baud rate, and direct connections for inputs and outputs to a digital recorder at any baud rate
- S-100 bus compatible
- Board only \$35.00 Part No. 112, with parts \$110 Part No. 112A



SYSTEM MONITOR

8080, 8085, or Z-80 System monitor for use with the TIDMA board. There is no need for the front panel. Complete with documentation \$12.95.

16K EPROM

Uses 2708 EPROMS, memory speed selection provided, addressable anywhere in 65K of memory, can be shadowed in 4K increments. Board only \$24.95 part no. 7902, with parts less EPROMS \$49.95 part no. 7902A.



ASCII KEYBOARD

TTL & DTL compatible • Full 67 key array • Full 128 character ASCII output • Positive logic with outputs resting low • Data Strobe • Five user-definable spare keys • Standard 22 pin dual card edge connector • Requires +5VDC, 325 mA. Assembled & Tested. Cherry Pro Part No. P70-05AB. \$119.95.



ASCII KEYBOARD

53 Keys popular ASR-33 format • Rugged G-10 P.C. Board • Tri-mode MOS encoding • Two-Key Rollover • MOS/DTL/TTL Compatible • Upper Case lockout • Data and Strobe inversion option • Three User Definable Keys • Low contact bounce • Selectable Parity • Custom Keycaps • George Risk Model 753. Requires +5, -12 volts. \$59.95 Kit.

ASCII TO CORRESPONDENCE CODE CONVERTER

This bidirectional board is a direct replacement for the board inside the Trendata 1000 terminal. The on board connector provides RS-232 serial in and out. Sold only as an assembled and tested unit for \$229.95. Part No. TA 1000C

DISK JACKET™

Made from heavy duty .0095 matte plastic with reinforced groggmets. The mini-diskette version holds two 5-1/4 inch diskettes and will fit any standard three ring binder. The pockets to the left of the diskette can be used for listing the contents of the disk. Please order only in multiples of ten. \$9.95/10 Pack.

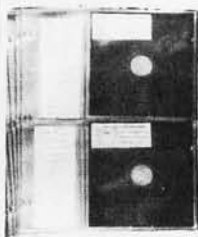

ATARI 800

Computer with 8K \$995.00, disk drive \$549.00, printer \$599.99



VIDEO TERMINAL

16 lines, 64 columns • Upper and lower case • 5x7 dot matrix • Serial RS-232 in and out with TTL parallel keyboard input • On board baud rate generator 75, 110, 150, 300, 600, & 1200 jumper selectable • Memory 1024 characters (7-21L02) • Video processor chip SFF96364 by Neculonic • Control characters (CR, LF, →, ←, ↑, ↓, non destructive cursor, CS, home, CL • White characters on black background or vice-versa • With the addition of a keyboard, video monitor or TV set with TV interface (part no. 107A) and power supply this is a complete stand alone terminal • also S-100 compatible • requires +16, & -16 VDC at 100mA, and 8VDC at 1A. Part No. 1000A \$199.95 kit.



RS-232/20mA INTERFACE

This board has two passive, opto-isolated circuits. One converts RS-232 to 20mA, the other converts 20mA to RS-232. All connections go to a 10 pin edge connector. Requires +12 and -12 volts. Board only \$9.95, part no. 7901, with parts \$14.95 Part No. 7901A.



COMPUCOLOR II

Model 3, 8K \$13.95, Model 4, 16K \$14.95, Model 5, 32K \$16.95. Prices include color monitor, computer, and one disk drive.



PET COMPUTER

With 16K & monitor - \$795. Dual Disk Drive - \$10.95



apple II or APPLE II PLUS

16K - \$975, 32K - \$1059, 48K - \$1123. Disk & cont. \$589



CASSETTE TAPE ERASER



REMOVES RECORDINGS IN ONE SECOND! The process eliminates static positive / negative ions and maintains original tone quality with minimal tape hiss • To improve tone quality • To reduce hissing • For quick and easy to erase • No battery or liquid required • Powerful and effective action • Unconditional 2 year guarantee. ERASER-8 \$19.95.

16K RAMS

For the Apple, TRS-80 or Pet \$8 each Part No. 4116/2117.

APPLE II HOBBY/PROTOTYPING CARD

\$14.95 Part No. 7907

T.V. INTERFACE

- Converts video to AM modulated RF, Channels 2 or 3. So powerful almost no tuning is required. On board regulated power supply makes this extremely stable. Rated very highly in Doctor Dobbs' Journal. Recommended by Apple
- Power required is 12 volts AC C.T., or +5 volts DC
- Board only \$7.60 part No. 107, with parts \$13.50 Part No. 107A

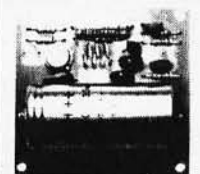

PARALLEL TRIAC OUTPUT BOARD FOR APPLE II

This board has 8 triacs capable of switching 110 volt 6 amp loads (660 watts per channel) or a total of 5280 watts. Board only \$15.00 Part No. 210, with parts \$119.95 Part No. 210A.

To Order: Mention part no., description, and price. In USA shipping paid by us for orders accompanied by check or money order. We accept C.O.D. orders in the U.S. only, or a VISA or Master Charge no., expiration date, signature, phone no., shipping charges will be added. CA residents add 6.5% for tax. Outside USA add 10% for air mail postage and handling. Payment must be in U.S. dollars. Dealer inquiries invited. 24 hour order line (408) 448-0800



Send for FREE Catalog . . . a big self-addressed envelope with 41¢ postage gets it fastest!

ELECTRONIC SYSTEMS Dept. B P. O. Box 21638, San Jose, CA USA 95151

APPLE II PLUS**

(limited offer)
16K only **\$990.00**

Disk I	475.00	Firmware Card	175.00
Disk II w/Controller	575.00	Proto Card	22.00
Pascal Card	475.00	M & R Modulator	29.95
Parallel Printer Card	165.00	Sanyo Cassette	54.96
Communications Card	210.00	16K Upgrade Kit	69.95
Business Software Pkg.	625.00	Apple Radio Car	159.00
10 Megabyte Hard Disk	4695.00	8" Floppy Controller	350.00
D.C. Hayes Modem	349.95	Heuristics Speechlab	179.95



ADVANCED COMPUTER PRODUCTS

FLOPPY DISK DRIVES

MPI 5 1/4" 40 tracks	279.00	PERSCI Model 277 Dual	1195.00
Shugart SA400-51" 35 tracks	295.00	WANGO/SIEMENS 5 1/4" Drive	290.00
Shugart 800/801R 8"	495.00	MPI 5 1/4" Dual	395.00
Siemens Shugart Compatible		WANGO/SIEMENS 282 Dual 5 1/4"	395.00
Model 120-BD	449.00		

TI 99/4



Finally! We've heard so much about it and we are proud to offer:
• Color • Up to 72K • 16 Color Graphics • Music • Sound • Solid State Software

LIMITED QTY: **\$1150.00**

TRS-80/APPLE MEMORY EXPANSION KITS

4116's
16K (200/250 ns.)
8 pcs. for **\$69.95**
w/instructions & jumpers.

16K EXIDY SORCERER ONLY \$1099.00



\$1099 w/16K
\$1249 w/32K
\$1449 w/48K

User programmable or use cartridges. Combines the desirable features of the PET, APPLE and TRS-80 into a complete expandable computer system.
** I/O expansion kit \$149.00
** Vista Exidy Dual Floppy Add-on \$1199.00

- ** New Word Processing Pac \$249.00
- ** INCLUDES: Keyboard & enclosure 90 day Warranty MICROSOFT BASIC Video & Cassette Cable Complete Documentation
- ** \$100 Expansion Module Add \$449.00
- ** Cassette recorder Add \$44.95
- ** Sanyo 9" Monitor Add \$169.95

Z80 Starter Kit \$249

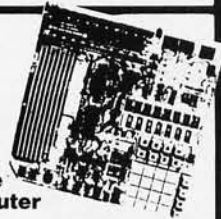

A Complete Microcomputer on a Board
★ Z80 Central Processing Unit with 158 Instructions.
★ On-Board Keyboard and Display.
★ Kansas City Standard Cassette Interface.
★ PROM Programmer Built on-board.
★ Expansion provision for two S-100 Connectors.
★ Wire Wrap area for custom circuitry.



HICKOK LX303 \$74.95

.5%, 3 1/2 digit 19 Range DVM, 1/2" LCD displays runs 200 hrs on 1 battery. 10 Meg Ohm Input. 1 yr. guarantee, made in U.S.A., test leads included.

Available Accessories

RC-3 115V AC Adapter	\$7.50
CC-3 Deluxe Padded Vinyl Carrying Case	\$7.50
VP-10 X10 DCV Probe Adapter/ Protector 10 Kv.	\$14.95
VP-40 40 Kv DC Probe	\$35.00
CS-1 10 Amp Current Shunt	\$14.95

... and it's COLOR SALE \$100.00 OFF "The Compucolor II"

... a personal colorgraphics system for the modern computer man ...

- ★ Color Graphics 13" Color CRT
- ★ Proven 8080A CPU System
- ★ 16K Extended Disk Basic
- ★ Up to 117* Key Keyboard
- ★ Up to 32K* RAM
- ★ Minidisk Drive 51.2K Bytes/Side



Model 3 w/8K, 72 Key Keyboard, RS232	\$1595.00
Model 4 w/16K, 72 Key Keyboard, RS232	\$1895.00
Model 5 w/32K, 72 Key Keyboard, RS232	\$2195.00
Options: 101 Key Keyboard	Add \$150.00
117 Key Keyboard	Add \$225.00
Formatted Diskettes	2/\$59.95
Programmed Diskettes	\$19.95
Diskette Library Inc. Hangman, Othello, Math, Chess, Startrek, Blackjack, Cubic Tic Tac Toe, Finance Vol. I, Finance Vol. II, Bonds and Securities, Assembler, Text Editor, Personal Data Base	\$19.45 - \$29.00

EASTER BASKET SPECIALS \$19.95 EACH



- Large Digital Scoreboard
- Forward, Left and Right Action Control Keys
- Two Levels of Speed and Skill
- Sound Effects
- Digital Clock and LED Scoreboard
- Four Directional Movements
- Three Shooting Keys for Angle Shots
- Sound Effects
- Professional and Amateur Speeds
- Extra Large Playing Field

ELECTRONIC FOOTBALL ELECTRONIC SOCCER

PROCESSOR TECHNOLOGY SALE SEND FOR COMPLETE INVENTORY LIST

SOL nKRA (expandable to 65K) RAM boards. Assembled and socketed w/o memory, data delay and proms. Only \$139.95

Data Delay Lines	\$29.95
Sol-20 Keyboards	Only \$139.95
Sol Keyboard Enclosure	\$44.95

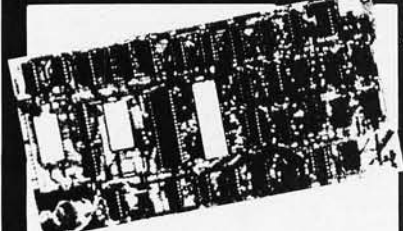

VDB-8024 Video Display Board \$319 KIT

With On-Board Z80 Microprocessor
★ Full 80 Characters by 24 lines display.
★ Characters displayed by High Resolution 7 x 10 Matrix.
★ Keyboard Power and Interface.
★ Composite Video Output.
★ Separate TTL Level Synchronization and Video Outputs.
★ 2K Bytes Independent On-Board Memory.
★ On-Board Z80 Microprocessor.
★ Glitch Free Display.

ATARI 800 & 400



ATARI 800 \$899.00
Includes: Computer Console BASIC Language Cartridge Education System Master Cartridge BASIC Language Programming Manual 800 Operator's Manual w/Notebook Atari 410 Program Recorder Guide to BASIC Programming Cassette 8K RAM Module Power Supply TV Switch Box

ATARI 400 \$499.00
Includes: Computer Console BASIC Language Cartridge BASIC Language Programming Manual 400 Operator's Manual w/Notebook Power Supply TV Switch Box

KIM-1 Now only \$179.00

- ★ Power Supply Add \$59.95
- ★ Cassette Recorder Add \$44.95
- ★ Sanyo 9" Monitor Add \$169.00

Add enclosure \$29.95.

AIM 65 \$375.00

★ On Board 20 column alphanumeric printer

w/1K RAM	\$375.00
w/4K RAM	\$450.00
Assembler ROM	Add \$85.00
BASIC IN ROM	Add \$100.00
Power Supply	Add \$69.95
Enclosure	Add \$49.95

SYM-1 IN STOCK Now \$219.00

- ★ KIM-1 Compatible
- ★ 4K ROM Monitor
- ★ 1K Bytes 2114 RAM
- ★ 65K Memory Expansion
- ★ User EPROM 2716 Add \$59.95
- ★ Power Supply Add \$44.95
- ★ Cassette Recorder Add \$44.95
- ★ Sanyo 9" Monitor Add \$169.95
- ★ SVM Enclosure \$39.95

School & group discounts available

Buy now and receive \$100.00 worth of discount coupons: i.e.

- ★ SRM-1 1K Static RAM exp. reg. \$42.00 disc. \$32.00
- ★ PEK-1 I/O Port disc. \$50.00
- ★ reg. \$80.00
- ★ SYM-BAS-1 Basic ROM (Microsoft) reg. \$59.00 disc. \$109.00
- ★ KFM-2 CRT/TV Keyboard reg. \$349.00 disc. \$319.00

SBC-100

Z-80 based singleboard computer by SD Systems

- ★ 1K RAM
- ★ RS232 port
- ★ 4 channel counter/timer

Kit \$239.00
Assembled \$369.00

Cromemco Z80

4 MHz Computer Single Card

Cromemco's Single Card Computer is a complete computer which brings the power of the Z-80 and the flexibility of the S-100 bus to the dedicated computer environment.

SCC-W/Assembled **\$450.00**

Processor: 4MHz Z-80
Instruction Set: 158 instructions incl. the 78 instructions of the 8080
ROM Type: Intel 2716 PROM or equivalent
ROM Capacity: 8K Bytes located from address 0000 to 1FFF
RAM Capacity: 1K Bytes located from address 2000 to 23FF
RAM Type: 4045, Static.

RCA COSMAC VIP

NEW LOW PRICE **\$249.00**
Assembled. Regular price \$299.95
w/Sanyo 9" Monitor \$169.95

The Supermarket for TRS-80* Add-on Components (and other computers, too)

In stock now. Immediate delivery.

The VISTA V-80 Disk Drive System

- 23% more storage capacity than TRS-80
- 120 day warranty
- 40 track patch at NO CHARGE



Single drive system \$ 395.00
 Two drive system \$ 770.00
 Four drive system \$ 1450.00
 Two drive cable \$ 29.95
 Four drive cable \$ 39.95

The VISTA V-80 Expansion Module

- Provides double density modification to your current Radio Shack interface (lets you format diskettes in either single or double density).
- Increases storage capacity up to 204K bytes (on single 40 track drive).
- Includes all hardware and software.

\$239.00



The VISTA Model II

- Provides one, two or three drives.
- Adds up to 1.5 million bytes of on-line storage.
- 120 day warranty
- Does everything Radio Shack's expansion system will do...for less!

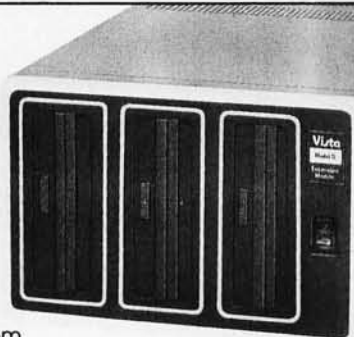

\$1000.00 Single drive Expansion System
\$1550.00 Two drive Expansion System
\$2100.00 Three drive Expansion System
\$ 525.00 Additional drives alone

The TRS-80 Printers

Centronics 730... **\$945.00**
 7x7 dot matrix-80 column

Anadex DP8000... **\$895.00**
 9x7 dot matrix-80 column

VISTA Printer... **\$745.00**
 5x7 dot matrix-80 column

Cables **\$27.50 each**



Other Products

1. VISTA Verbatim diskettes (hard or soft sector) Certified 40 track **\$ 38.95**
2. 16K RPM upgrade kits, guaranteed for 120 days.
PRIME PRODUCT **\$ 74.50**
3. NEW! DOS + **\$ 110.00**
4. LNW expansion bare board **\$ 66.95**
5. H.C. Pennington book, **TRS-80 Disk and Other Mysteries** **\$ 18.95**
6. DDT Disco-Tech disk drive timer **\$ 19.95**
7. Cryptext (An Encryption Module) **\$299.00**

Add On Drives

- | | | |
|---------|---------------------------------------|-----------------------|
| MPI B51 | 40 Track, Double Density-204K | \$275.00 |
| MPI B52 | Dual Head, Double Density-408K | \$375.00 |
| Siemens | FDD100-5 40 Track Double Density 204K | \$275.00 |
| Siemens | FDD100-5 Flippy, records both sides | \$290.00 |
| Siemens | FDD100-8 8" Single Sided Drive | \$448.00 |

The VISTA V-200 for Exidy

- Completely packaged system, tested and ready to plug in, includes: power supply, two 40 track drives, case, controller, all cabling and total CPM documentation.
 - Storage capacity from 400K to 1.2 meg.
 - System software-VISTA CP/M Disk Operating System and BASIC-E Compiler recorded on 5-1/4" diskettes.
- Price: Starting as low as **\$1199.00**



CALL TOLL-FREE 800-854-8017

The Vista Computer Company 1401 Borchard Street • Santa Ana, California 92705 • 714/953-0523

*TRS-80 is a registered trademark of Radio Shack.

Unclassified Ads

FOR SALE: RCA Cosmac VIP CDP1802. Fully assembled and working beautifully. Pixe-Verter for television and cassette recorder included. Also, two manuals and one issue of *Viper* magazine. Asking \$200 or best offer. I pay shipping. Jeff Roberts, 1800 Huntington Tpke, Trumbull CT 06611, (203) 375-9430.

FOR SALE: Three 6800 systems at my cost less 50 to 70%. AMI PROTO processor, Davis 16 K random-access-memory boards, MSI/GSI disks, IDS printers. Buy system or components. Send SASE for complete list of components and prices. Phil Reagan, 1557 Jackson St #106, Oakland CA 94612, (415) 839-3409.

FOR SALE: Radio Shack TRS-80, Level II, 16 K. Complete system (processor/keyboard, video monitor, cassette recorder). Plus some programs, assorted books, and many cassettes. One-year-old, used three months. Sacrifice at \$650. Stan Birnbaum, 1610 Hudson St Apt 4, Helena MT 59601, (406) 443-7320.

WANTED: Sanders 708 video display terminal, or equivalent, for X-Y vector displays. Send details, including price and condition. George B Konizer, 2008 N Brailsford Rd, Camden SC 29020.

WANTED: A ZE, ZB, ZC, or ZD erasable read-only memory for Digital Group Z80 board. A Z80 operating system cassette for 1024 TVC, also by Digital, or a good copy of same. You name the price. Fred A Bufanio, 96 Overlook Ter, Bloomfield NJ 07003.

FOR SALE: PerSci dual 8-inch disk drive, double-density rated with cable for direct input/output (I/O), Model #2142; also, controller card for S-100 bus. Both one-year-old and working. Original cost over \$2700; sell for \$2300. Richard Turner, 1420 Balboa Av Apt J-75, Panama City FL 32401, (904) 769-8025 Wednesday and Friday evenings and weekends.

FOR SALE: TRS-80 computer system 16 K Level II, expansion interface, RS-232 interface, and disk drive with disk operating system disk (all cables included). Excellent condition. Buying larger system. My cost \$1900, will sell for \$1600 or best offer. S Phail, 4900 Bristow Dr, Annandale VA 22003, (703) 941-4075.

WANTED: MITS 88-2SIO input/output (I/O) board. All integrated circuits must be socketed and board must be in working order. R Tsubota, Rt 2 POB 442, Ontario OR 97914.

FOR SALE: Heathkit H8 computer system with 16 K, H8-5 input/output (I/O) cassette interface, H9 video terminal, and HC8-14 cassette software system. All factory tested and running. Includes all manuals, documentation, and software. \$1000 or best offer. (Canadian funds) Will ship. Reason selling: I have two computer systems. Robert Tremblay, 1316 Teillet, Ste-Foy Quebec, CANADA G1W 3C2.

WANTED: Apple II or Apple II Plus. No Apple is too small. If you want to trade up, give a hand to a beginner. Send a description and price. Please include your phone number. Everyone will receive a reply if at all possible. David Hayes, 537 Hall St, Ripon WI 54971.

WANTED: Information about fixes or patches for bugs in TDL-Xitan FORTRAN and/or Disk BASIC. Will pay with money or similar information known to me. Have written FORTRAN program for communication and file transfer between Micro and WYLBUR on 370. Will be happy to share. M Frankel, Dept of Statistics, Baruch College CUNY, 46 E 26 St, NYC NY 10010.

WANTED: Diablo 1650 print mechanism with or without interface. Or Selectric print mechanism with ASCII interface. Dennis Toeppen, 409 S HI Lusi, Mount Prospect IL 60056, (312) 255-2255 after 6 PM weekdays.

FOR SALE: Expander Black Box printer. See 11/77 *Kilobaud* for detailed article or 5/79 *Jade* ad for brief description of this compact eighty-column impact printer. Case, parallel interface, cable, connectors, documentation, and shipping included. Cost new is \$470. First \$300 bank check or money order gets mine. Used nine months. Fred Lepow, 1700 Circo del Cielo Dr, El Cajon CA 92020, (714) 440-9310 (nights) or (714) 276-3414 (days).

FOR SALE: Two Friden Flexwriter units. Each has paper-tape read/write on keyboard, a desk/console, and an auxiliary scanning/reader. \$265 each. Also, Tektronix 513 oscilloscope DC to 18 MHz; \$195. Gerald Orman, 7619 Forrest Av, Munster IN 46321, (219) 836-1514 evenings.

FOR SALE: IBM 1050 Data Communication System (RS-232). Consists of control unit, Selectric-based printer-typewriter, paper-tape punch, paper-tape reader. Full documentation. Excellent condition. \$800. SASE would be appreciated. Arkady G Makhlina, 39 Hammer-smith, Danbury CT 06810, (203) 743-9509.

FOR SALE: Two 2315 2.4 M bytes disk cartridges, Hewlett-Packard Model #12869A, in Wright Line Model #5835-20 disk pack carrying case; \$100 or reasonable offer. Fourteen Hewlett-Packard 9162-0050 digital cassettes; \$28 or reasonable offer. James R Schueler, 317 Chilean Av Rear, Palm Beach FL 33480.

FOR SALE: Altos/8000 (Model ACS 8000-1) with two 8-inch drives (1/2 Mb), 64 K main memory, CP/M operating system, Xitan Extended Disk BASIC, Texas Instruments' (Model 810) 150 characters per second (cps) printer with fork length control, Volker Creig video display with numeric pad, detachable keyboard, and addressable cursor. John Whiffen, (416) 279-1496 (CANADA).

FOR SALE: Intel single-board, computer-based system. Includes: SBC-80/10 (8080A processor card), SBC-104 (4 K random access memory, input/output (I/O), etc), SBC-116 (16 K random access memory, read-only memory, I/O), SBC-310 (high-speed math processor), SBC-534 (four-channel serial I/O), SBC-604 (card cage), SBC-635 (14 A power supply). Also, SBC-80/04 (8085 processor), ultraviolet programmable read-only memory eraser, National Multiplex digital cassette recorder, and DEC LA-36 terminal. Will negotiate price or trade. Jim Mortons, POB 65, Fond du Lac WI 54935.

FOR SALE: PDP-11 boards. Removed from working PDP-11/15. Complete processor. Very powerful. Too many boards to list. One Hex (front panel), four Quad, six Dual, three Single, seven Single small. Twenty-one boards in all. \$60. Take advantage of the low value of the Canadian dollar and buy. Write for complete information. David Lai, 13250 Racine St, Pierrefonds Quebec, CANADA H8Z 1Y7.

FOR SALE: Three IMSAI 4 K random-access-memory boards for S-100 bus with individual 1 K write-protect. \$85 each. One Polymorphics video board with 16 by 64 characters, 48 by 128 graphics, 1 K of on board random access memory, and an 8-bit parallel port for keyboard. Also for S-100 bus. \$160. Everything assembled. Peter Hack, 579 Diamond St, San Francisco CA 94114, (415) 824-4225.

FOR SALE: Commodore PET 2001/8 with full documentation. Assorted software games included. Excellent condition, burned in, and running. \$525. Michael DiMario, 4300 N 92 St Apt 1, Milwaukee WI 53222, (414) 476-8300 ext 720 days, (414) 463-0836 evenings.

FOR SALE OR TRADE: I will design and print a single- or double-sided printed-circuit board from your specifications on my Tektronix graphics computer. Will trade for surplus computer gear. Send SASE for sample of my work. Rex Taylor, 2367 NW Kearney, Portland OR 97210.

Unclassified Policy

Readers who are soliciting or giving advice, or who have equipment to buy, sell or swap should send in a clearly typed notice to that effect. To be considered for publication, an advertisement must be clearly noncommercial, typed double spaced on plain white paper, contain 75 words or less, and include complete name and address information.

These notices are free of charge and will be printed one time only on a space available basis. Notices can be accepted from individuals or bona fide computer users clubs only. We can engage in no correspondence on these and your confirmation of placement is appearance in an issue of BYTE.

Please note that it may take three or four months for an ad to appear in the magazine.

FOR SALE: VIM single-board microcomputer in original box with all documentation; \$195. Also, Radio Shack Editor-Assembler for TRS-80 unused; \$25. V M Faulkner, RR 2 POB 294A, Yorktown IN 47396, (317) 289-4138.

FOR SALE: IMSAI 8080, 22-slot mother board, 2P + S, Tarbell cassette, 16/32 K erasable-programmable read-only memory, Godbout active terminator, 8 K Seals + 24 K Godbout random access memory, H9 terminal, Mullen extender. \$2000. Larry, 516 E St, Galt CA 95632, (209) 745-1843.

FOR SALE: Two Processor Technology 16 K dynamic programmable memory boards #16KRA for SOL or S-100 system. See January 1977 BYTE, page 10. With manual. 32 K for \$200. Not sold separately. First check or money order takes it. Bob Duke, 13526 Pyramid Dr, Dallas TX 75234, (214) 241-2888.

OLD COMPUTING DEVICES: Do you have or know about planimeters, integrators, integrators, mechanical computers, pre-1900 calculators, or other unusual early computing machines? Do you have books, manuals, or other documentation about them? I am buying, studying, and exchanging stories about these things. What's the weirdest computing machine you know of? I'd particularly like to hear about unusual projects, both historical and recent. Dick Rubinstein, 15 Maugus Av, Wellesley MA 02181.

FOR SALE: Digital Group standard mother board, Z80 processor board, input/output (I/O) board, TVC/cassette interface, George Risk keyboard in oak cabinet, TV monitor conversion kit, dual Phi-Deck and controller board, nonstandard power supply and cabinet. All documentation and system programs included. Boards assembled by professional digital technician. System never calibrated or run. \$800 complete or trade for TRS-80 disks or printer. Jim Lewis, POB 22045, Knoxville TN 37922.

WANTED: I need a few odd integrated circuits for repairs to circuit boards made by Intel Corp. Type numbers are: P3404, MC3002, 8267, 8263, NE550, MC3003. Damaged boards with salvageable usable circuits would be satisfactory. Merle Vogt, POB 145, Von Ormy TX 78073.

WANTED: Hewlett-Packard 9830 in excellent working condition, preferably under H-P maintenance. With plasma display, tape cartridge drive, thermal printer, BASIC, and manual. R Kesell, 345 W 88th St, NYC NY 10024, (212) 873-5556.

FOR SALE: Upgrading all TRS-80 Model I equipment to Model II. Must sell like-new expansion interface with 32 K random access memory. Only \$470. Two Shugart disk drives with cable, and four MPI disk drives with cable. Your choice only \$385 per drive. Buy two or more drives and get the cable free. One Centronics printer (call or write for price). Bruce Taylor, 118 S Mill St, Pryor OK 74361, (918) 825-4844, after 6:00 PM (918) 434-5242.

Reader Service

To get further information on the products advertised in BYTE, fill out the reader service card with your name and address. Then circle the appropriate numbers for the advertisers you select from the list. Add a 15-cent stamp to the card, then drop it in the mail. Not only do you gain information, but our advertisers are encouraged to use the marketplace provided by BYTE. This helps us bring you a bigger BYTE. *Correspond directly with company.

Inquiry No.	Page No.	Inquiry No.	Page No.	Inquiry No.	Page No.	Inquiry No.	Page No.
106	Aardvark Software 167	209	DATABANK 240	•	Micro Diversions (Scion Corp.) 5	259	Quest 271
244	AB Computers 266	127	Data Discount Center 188	133	Micro Innovations Corp 191	200	RACET Computes 233
277	Advanced Computer Prod 284, 285	186	DataDisk Sys 224	170	Micro Integration 217	246	Radio Hut 267
132	AL Industries 191	197	Datsouth Computers 231	176	Micromail 219	80	Radio Shack 131
255	ALL Electronics 268	48	DATASPEED 83	130	Micro Management Systems 190	154	Raygam 205
68	Altos 106, 107	73	Delta Products 117	247	Micro Mart 268	•	RBB 226
218	American Square Computers 258	264	DES-MAR Electronics 272	23	Micro Mikes 177	96	RCA Solid State 152
267	Ampero Software 272	141	DG Electronics 195	151	Micro Music 202	•	Reliable Cash Register 241
44	Anadex Inc 79	85	Digital Pathways 137	193	Micropolis 228, 229	8	RITAM International Corp 18
114	Anderson Jacobson 176	243	Digital Research: Computers 265	231	Micro Products Unlimited 262	204	RNB Enterprises 236
79	Andicom Technical Products 127	84	Digital Research Corp (CA) 136	52	Micro Pro International 88, 89	74	Robotics Age 119
125	Apparal 187	42	Digital Technology Inc 77	288	Microsette 199	167	S-100, Inc 215
•	Apple Insert	12	Digitus 25	220	Microsette 258	101	Howard W. Sams Company 159
195	Applied Computer Systems 229	165	Disc/3 Mart Inc 214	69	Microsoft 109	121	Sara Tech 185
266	Aristo/Polks 272	169	Dr Dobb's Journal 216	21	Microtek 47	159	SCDP 211
138	Artac Electronics 194	123	Dynacomp 186	184	MICROWARE 223	98	Scelbi 154, 155
152	Artac Electronics 203	212	Dynamic Microprocessor Assoc. 241	188	Microware Associates 225	71	Scientific American 113
270	ASAP Computer Products 273	•	Eaton LRC 26, 29	102	The Micro Works 160	58	SciTronics 94
•	Atari 13	229	Electrolabs 261	105	Micro World 166	32	Seattle Computer Products 69
92	ATV Research 258	272	Electrolabs 274, 275	140	Midwest Computer Peripherals 195	32	Seattle Computer Products 235
92	Automated Simulations 145	•	Electronic Control Technology 96	241	Mikos 264	99	Michael Shrayner 157
17	Avionic Enterprises (A.E.I.) 219	276	Electronic Systems 282, 283	131	Mini Computer Suppliers 190	•	Shugart 6, 7
13	AXIOM Corp 27	224	Electronic Technicians 258	117	Mini Micro Mart Inc 181	187	Sigma International 224
250	B & W Energy Management Sys 268	171	Escon 217	155	Mini Micro Mart Inc 206	282	Sirius Systems 78
203	Ballantine Books 235	177	Essex Publishing 220	25	Morrow/Thinker Toys 55	108	Small Business
295	BASF 175	118	Exidy 182, 183	70	Mountain Hardware 111	•	Applications 169
271	Beckman 273	249	Factory Direct Sales 198	157	Mountain Hardware 207	194	Ed Smith's Software Works 229
223	John Bell 258	206	Faragher & Assoc 268	324	Multi Business Computer Sys 258	7	Smoke Signal Broadcasting 53
•	Beta Computer Devices 225	206	Farnsworth Computer 239	144	National Artificial Intelligence Lab (NAIL) 197	24	Smoke Signal Broadcasting (Dealers) 53
146	Biotech Electronics 198	252	Feith Software 268	226	NCE/CompuMart 259	50	Softagon Inc 86
107	Bishop Graphics 207	82	Financial Planning Associates 98	77	NEECO 115, 124, 125	192	Softape 227
156	BIZCOMP 168, 268	183	Five Stones Software 223	86	Netronics 138	120	Softech 185
75	The Bottom Shelf 121	227	Fordham Radio Supply 260	283	Netronics 179	89	The Software Exchange 141
113	BYTE Books 59	233	Frederick Computer Products 262	284	Netronics 179	230	The Software Farm 262
213	BYTE Seminar 243	30	Freeland Intl Computer Shows 65	261	New England Recruiters 272	54	The Soft Warehouse 90
•	Byte Shop East 139	237	Fuller Software 262	14	North Star 31	242	Solid State Sales 264
•	BYTE Subscriber 239	137	Futureworld 193	232	Northwest Computer Services 262	262	Sorrento Valley Associates 272
134	C & S Electronics Mart 192	260	Gimix 272	110	Novation 172	279	Southwest Tech Prod Corp CII
5	California Computer Systems 14, 15	173	Global Parameters 218	•	NRI Schools 161	3	SSM 11
221	California Data Corp 258	90	Godbout Electronics 143	281	Ohio Scientific Instrument CIV	205	The Stackworks 237
274	California Digital 279	158	GR Electronics 208	67	OK Machine and Tool 105	104	Strategic Simulations, Inc. 165
207	California Software 239	97	H & E Computronics 153	129	OK Machine & Tool 189	91	SubLOGIC 144
139	Cambridge Development Labs 195	17	Hamilton/Avnet 39	268	The Old Association 272	258	Sunny International 270
263	CAP Electronics 272	88	Hardside 140	55	Olivetti 91	94	Supersoft 149
81	Central Data 133	257	Hobby World 270	•	onComputing 33	99	Supersoft 209
265	Chafitz, Inc. 272	292	Houston Instruments 51	•	Onyx Sys., Inc. 42, 43	41	Sybox 75
112	Chrislin Industries 174	293	Houston Instrument 51	211	Optimal Technology 241	65	Sybox 100
116	Chrislin Industries 180	11	Industrial Micro Systems 23	66	Oregon Software 103	49	Synchro Sound 85
256	Cleveland Consumer Computer & Components 269	61	InfoSoft Systems Inc 97	109	Osborne/McGraw-Hill 171	46	Tab Books 81
64	Compas Micro Systems 100	26	Intecolor 57	•	Owens Associates 213	76	Tarbell Electronics 123
9	CompuCorp Corp 19	179	Integrand 221	43	Pace Inc 78	51	Tech Sys Consultants (TSC) 87
29	CompuServe (microNET) 63	160	International Data Sciences 211	286	Pacific Exchanges 199	10	Tec-Mar 158
240	Computer City 263	83	International Data Systems (IDS) 135	326	Page Digital 278	235	Televideo 21
251	Computer and Control Affiliates 268	28	Intertec Data Systems 61	166	PAIA 214	189	Theta Labs Inc 262
•	The Computer Factory (NY) 170	2	Ithaca Intersystems 9	186	Pan American Elec (A Radio Shack Auth. Sales Ctr.) 221	126	Robert Tinney Graphics CVIII
142	Computer Furniture & Accessories 196	16	Ithaca Intersystems 36	31	Per Com Data 67	•	TransNet 188
•	Computer Hardware 200	273	Jade Company 276, 277	33	Per Com Data 71	20	United Software of America 76
47	Computer Mart of NJ 82	275	Jameco 280, 281	34	Per Com Data 72	•	Universal Data Systems 45
210	Computer Service Center 240	150	JRT Systems Inc 201	35	Per Com Data 72	185	US Robotics 223
238	Computer Shopper 262	6	Konan Corp 16	36	Per Com Data 72	222	Vantage Data Products 258
161	Computer Specialties 211	93	Lifeboat Associates 101, 134, 189	37	Per Com Data 73	148	Vector Electronic Co 200
172	Computer Transceiver Sys (CTS) 217	182	Macrotronics 146	38	Per Com Data 73	115	Vertec 178
201	Computers Wholesale 235	•	Macrotronics 222	39	Per Com Data 73	299	Vista Computer Company 286
163	Computer World 213	•	McGraw-Hill Book Company 128, 129	40	Per Com Data 73	245	VR Data 266
153	Computex 204	253	Measurement Sys & Controls 41	59	Personal Software 93	228	Wameco 260
199	Corporate Computer Systems Inc 233	190	Measurement Sys & Controls 199	57	Personal Software 95	111	Western I/O 173
56	Corvus Systems 92	15	Metaresearch 268	143	Pickles & Trout 197	•	Whitesmith's Ltd 151
122	Cover Craft 185	72	MICAH 227	178	Pickles & Trout 221	100	John Wiley & Sons, Inc 173
128	CP Products 189	162	Micro Age Computer Stores 35	248	Potter's Programs 268	214	John Wiley & Sons, Inc. 244
1	Cromemco 1, 2	219	Microamerica Dist 115, 124, 125	45	Power One 80	236	Wintek 262
119	CT microCOMPUTER, Inc 184	278	Micro Applications Group 213	215	Priority One 255	208	Worldwide Electronics 240
135	CT microCOMPUTER, Inc 192	124	Micro Architect 258	216	Priority One 256, 257	168	Z _s Systems 215
174	Cybernetics Inc 219	22	Micro Business World 254	191	The Q Kit (Div J R Conwell) 227		
234	DAR Sales 262	63	Microcomputer Technology Inc 187	198	Quality Software 233		
136	DataArt, Inc 193		MicroDaSys 49				
			Micro Data Base Systems Inc 99				

BOMB - BYTE's Ongoing Monitor Box

Article #	Page	Article	Author
1	17	Ease into 16-Bit Computing: Get 16-Bit Performance from an 8-Bit Computer	Ciarcia
2	34	Electron Behavior in a Chemical Bond	Liebl
3	60	Hewlett-Packard's New Personal Computer, The HP-85	Morgan
4	74	Solving Problems Involving Variable Terrain, Part 2: Special Cases, Including Hexagonal Grids	Jones
5	84	TRS-80 Performance, Evaluation by Program Timing	Lewis
6	114	Electronic Planimetry	Santi, et al
7	126	A Power-Line Protection Circuit	Schneider, Erickson
8	130	Landing Module Simulation with Random Surface	Houng
9	142	The Dirt-Cheap Bootstrap, More Notes on Bringing Up a Microcomputer	Woodhull
10	156	Hydrocarbon Molecule Constructor	Matthews
11	194	Operation Codes for 8080, 8085, and Z80 Processors	Harrell
12	230	To Err is Human	McGregor
13	232	Super TIC	Roehrig

December BOMB Numerical Analysis

"Add Nonvolatile Memory to Your Computer" by Steve Ciarcia (page 36) proved to be the most popular among those readers who voted. Second place in the BOMB voting went to James L Peterson for "Text Compression" (page 106). These two authors receive the \$100 first-place and \$50 second-place prizes. Third place was shared by F R Ruckdeschel ("Frequency Analysis of Data Using a Microcomputer," page 10) and Christopher O Kern ("A User's Look at Tiny-C," page 196). ■



250/750 **BREAKING THE SOUND BARRIER** ROBERT TINNEY

September 1977



250/750 **THE TRAP DOOR** ROBERT TINNEY

March 1979

Byte Cover Prints -- Limited Editions.

The September '77 and March '79 covers of BYTE are now each available as a limited edition art print, personally signed and numbered by the artist, Robert Tinney.

These prints are strictly limited to a quantity of 750 for each cover, and no other editions, of any size, will ever be published. Each print is 18" x 22", printed on quality, coated stock, and signed and numbered in pencil at bottom.

The price of each print is \$25. This includes 1) a signed and numbered print; 2) a Certificate of Authenticity, also signed personally by the artist and witnessed, attesting to the number of the edition (750), and the destruction of the printing plates; and 3) first class shipment in a heavy-duty mailing tube.

To order your limited edition art print, fill out and mail the order form below.

Send me _____ "Breaking the Sound Barrier" prints at \$25 each, and _____ "Trap Door" prints at \$25 each. I understand this price includes Certificate of Authenticity and first class shipment.

- I have enclosed check or money order to Robert Tinney Graphics.
 Charge this to my Master Charge or Visa
 Card # _____ Expires: _____

Ship my print(s) to:

Name _____
 Address _____
 City _____ State _____ Zip _____

Send order to:

robert tinney graphics
 P.O. Box 45047 • Baton Rouge, LA 70895



The home computer you thought was years away is here.



C8P DF \$2,597

Ohio Scientific's top of the line personal computer, the C8P DF. This system incorporates the most advanced technology now available in standard configurations and add-on options. The C8P DF has full capabilities as a personal computer, a small business computer, a home monitoring security system and an advanced process controller.

Personal Computer Features

The C8P DF features ultra-fast program execution. The standard model is twice as fast as other personal computers such as the Apple II and PET. The computer system is available with a GT option which nearly doubles the speed again, making it comparable to high end mini-computer systems. High speed execution makes elaborate video animation possible as well as other I/O functions which until now, have not been possible. The C8P DF features Ohio Scientific's 32 x 64 character display with graphics and gaming elements for an effective resolution of 256 x 512 points and up to 16 colors. Other features for personal use include a programmable tone generator from 200 to 20KHz and an 8 bit companding digital to analog converter for music and voice output, 2-8 axis joystick interfaces, and 2-10 key pad interfaces. Hundreds of personal applications, games and educational software packages are currently available for use with the C8P DF.

Business Applications

The C8P DF utilizes full size 8" floppy disks and is compatible with Ohio Scientific's advanced small business operating system, OS-65U and two types of information management systems, OS-MDMS and OS-DMS.

The computer system comes standard with a high-speed printer interface and a modem interface. It features a full 53-key ASCII keyboard as well as 2048 character display with upper and lower case for business and word processing applications.

Home Control

The C8P DF has the most advanced home monitoring and control capabilities ever offered in a computer system. It incorporates a real time clock and a unique FOREGROUND/BACKGROUND operating system which allows the computer to function with normal BASIC programs at the same time it is monitoring external devices. The C8P DF comes standard with an AC remote control interface which allows it to control a wide range of AC appliances and lights remotely without wiring and an interface for home security systems which monitors fire, intrusion, car theft, water levels and freezer temperature, all without messy wiring. In addition, the C8P DF can accept Ohio Scientific's Votrax voice I/O board and/or Ohio Scientific's new universal telephone interface (UTI). The telephone interface connects the computer to any touch-tone or rotary dial telephone line. The computer system is able to answer calls, initiate calls and communicate via touch-tone signals, voice output or 300 baud modem signals. It can accept and decode touch-tone signals, 300 baud modem signals and record incoming voice messages. These features collectively give the C8P DF capabilities to monitor and control home functions with almost human-like capabilities.

Process Controller

The C8P DF incorporates a real time clock, FOREGROUND/BACKGROUND operation and 16 parallel I/O lines. Additionally a universal

accessory BUS connector is accessible at the back of the computer to plug in additional 48 lines of parallel I/O and/or a complete analog signal I/O board with A/D and D/A and multiplexers.

Clearly, the C8P DF beats all existing small computers in conventional specifications plus it has capabilities far beyond any other computer system on the market today.

C8P DF is an 8-slot mainframe class computer with 32K static RAM, dual 8" floppies, and several open slots for expansion.

C8P \$895

Or get started with a C8P with cassette interface, 8K BASIC-in-ROM which includes most of the features of the C8P DF except the real time clock, 16 parallel I/O lines, home security interface and accessory BUS. It comes with 8K static RAM and Ohio Scientific's ultra-fast 8K BASIC-in-ROM. It can be expanded to a C8P DF later. Base price \$895. Virtually all the programs available on disk are also available for the C8P cassette system on audio cassette.

Computers come with keyboards and floppies where specified. Other equipment shown is optional.

For literature and the name of your local dealer, CALL 1-800-321-6850 TOLL FREE.

OHIO SCIENTIFIC
1333 SOUTH CHILLICOTHE ROAD
AURORA, OH 44202 • [216] 831-5600