

# Heathkit

Educational Systems

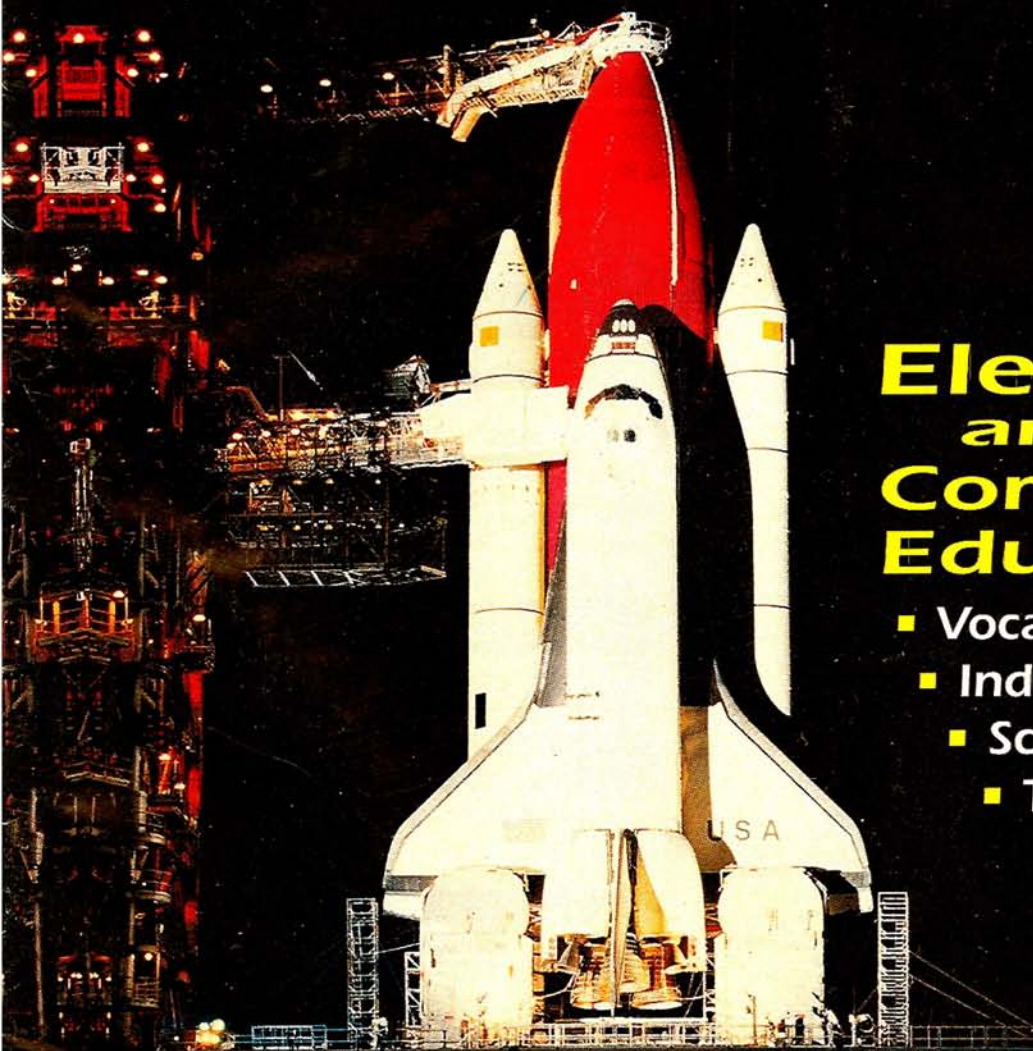

## Electronics and Computer Education

- Vocational Education
- Individual Learning
- School-To-Work
- Tech-Prep

**New!**

Courses in:

Personal Computer

- Servicing
- Troubleshooting
- Networking

# Table of Contents

## Introduction

page 3 - 9

## Media Descriptions

page 10 - 15

## Electronic Trainers

page 16 - 19

## Core Electronics

DC Electronics  
page 20 - 21

AC Electronics  
page 22 - 23

Semiconductors  
page 24 - 25

Electronic Circuits  
page 26 - 27

Electronic Fundamentals  
page 28 - 29

## Survey Electronics

Concepts of Electricity  
page 30

Concepts of Electronics  
page 31

## Advanced Electronics

Digital Techniques  
page 32 - 33

Microprocessor Programming  
page 34 - 35

Microprocessor Interfacing and  
Applications  
page 36 - 37

## Master Electronics

Master Course in Electronics  
Technology  
page 38 - 39

## Applied Computer

EZS-400 PC Servicing,  
Troubleshooting and  
Networking Package  
page 40 - 41

PC Servicing  
page 42

PC Troubleshooting  
page 43

PC Networking  
page 44 - 45

## Master Computer

Master Course in Personal  
Computers  
page 46 - 47

## Applied Electronics

VCR Servicing  
page 48

Camcorder Servicing  
page 49

TV Servicing  
page 50

Electronic Communications,  
Data Communications  
page 51

Laser Technology  
page 52

Electro-Optics  
page 53

## Oscilloscopes, Meters

Oscilloscopes  
page 54

Meters, Soldering Course,  
Soldering Iron  
page 55

## Heathkit Favorites

Advanced Weather Computer  
page 56

Most Accurate Clock,  
Digital Clock Kit,  
AM Radio Kit  
page 57

## Distributor Listing

page 58

## Ordering Information

page 59

## Doing Business Honorably

**30 DAY MONEY-BACK GUARANTEE  
ONE YEAR LIMITED WARRANTY FOR ALL  
HARDWARE &  
ALL EQUIPMENT**

# Learning Electronics The Successful, Proven, Heathkit Method



## The Great Technology Boom

Today, you'll find sophisticated electronics everywhere imaginable; in cars, ovens, traffic signals, even vacuum cleaners. Workers have found mechanical controls and gauges replaced by programmable logic controls and electronic sensors.

It's no surprise that a major challenge facing industry is finding qualified people—or retraining a workforce—to run, service and maintain the new high-tech equipment. Heathkit helps you succeed in bringing yourself and others from the industrial revolution into the electronics revolution.

## The Heathkit Heritage

Our technical training heritage goes back almost 50 years. We've introduced millions of people all over the world to electronics technology through our famous build-it-yourself kits with their easy to use, step by step instructions, and of course with our revered educational courses.

Today, Heathkit electronics learning systems are found in homes, classrooms and training labs all over the world. We work hard at Heathkit and are proud to have made Heathkit products the standard by which all such products are measured, in terms of quality, effectiveness and value.

## Credentials

Heathkit Educational Systems is licensed as a school by the Michigan Department of Education. Our Individual Learning Programs are accredited by the International Association for Continuing Education and Training (IACET). Our computer-aided instruction, textbooks, workbooks, videos, and trainers are integrated into thousands of electronics programs in prominent schools and industry leading corporations.

## Thorough Testing Ensures Quality

Before any of our equipment is offered for sale, it is thoroughly tested and fine-tuned to assure effectiveness, reliability and safety.

Unlike the other suppliers, Heathkit respects state and national regulations and safety requirements. We engineer our equipment to easily pass the standards of the FCC (Federal Communications Commission) and both UL (Underwriters Laboratory) and CSA (Canadian Standards Association). Built with heavy gauge construction, reinforced exterior components and protected power supplies—Heathkit trainers are the right choice for any electronics learning environment.

A word of caution, don't be fooled by a UL stamp on a power cord which says nothing of the actual equipment. Your state, school, or company may require UL Listed and FCC-legal hardware, so check, and protect yourself.

## Learning, Instructor-Led or Self-Paced

Different learning environments require different teaching approaches, especially in the world of high-tech electronics. This is where Heathkit really rises above the rest.

Teachers, you can be certain that Heathkit courseware will be effective in your classroom and flexible enough to fit your style of teaching.

If you are an individual preparing yourself for a new more exciting career, Heathkit has several electronics courses you can take on your own, at your pace, and earn continuing education units.

If you are training employees, Heathkit offers a variety of packages that will help you accomplish your training requirements.

## From Theory to Hands-On Practice

Heathkit learning systems are designed to help students make a smooth transition from theory to application. First, we lay a foundation of basic theory. Then we build on that foundation by teaching advanced concepts and using hands-on experiments to turn theory into real world application.

## Value

Because Heathkit fulfills the needs of so many customers, we are able to spread the costs of the course ware and equipment development over many more units than other companies. We also are one of the few suppliers that stock inventory ready for shipment. The bottom line is simply a smaller number on the bottom line of your sales invoice and quicker response to your needs. Higher quality, more effective, more innovative, less money, that's Heathkit Educational Systems.

Thank you for your interest and for this opportunity to serve you.

Sincerely,

  
Donald J. Desrochers  
President

# Setting the Standard for Teaching Excellence



## Heathkit, Improving the Learning Process

## For Both Instructor-Led and Individual Learning

### Student-Friendly, Instructor-Friendly, .....Effective

All of our courses are written in applications-based, student-friendly style using bite-size sections with easy-to-follow instructions and easy-to-understand language. Heathkit's electronics courses are unlike any others, and are very popular among students and instructors because they are so easy-to-use and effective.

Each course and every chapter begins with an overview of the subject outline and learning objectives. Once the concepts in a particular subject are covered, they are reinforced with summaries, quizzes, and hands-on experiments.

Heathkit courses are also designed with a flexible schedule in mind so you (as student or teacher) can decide on an intensive schedule or a more comprehensive and reinforcing schedule depending upon your requirements.

### Harness the Power of TV

Most Heathkit courses can be introduced with and/or reinforced with the use of our video tapes. These were developed to be very easy-to-follow and to visually drive-home the main topics covered in each course.

### From the Experts in Electronics

We've been successful by focusing on our customers' requirements and on the business in which we are experts—electronics.

## Improving the Learning Process

Many years ago, Heathkit was literally asked to enter the electronics education business by electronics instructors. It was very common to find teachers who had built Heathkit-supplied kits into TVs, stereos, amateur radios, etc. They learned a lot about electronics by following Heathkit's step-by-step assembly instructions and easy-to-understand explanations of electronics concepts.

We've spent nearly 20 years refining, honing, tweaking, perfecting, and continually updating the instructional methods that work best for both instructor-led and individual learning situations. For some companies, this is an objective. For Heathkit, it is a never-ending process.

## A Development Process Focused On Customer Requirements

We listen to the hundreds of letters and phone calls we get from students, teachers, and industrial trainers. We interview hundreds of instructors every year to find out how we can improve our courses in terms of effectiveness, time to complete, and cost.

Then, we challenge our staff of seasoned electronics courseware developers to modify existing courses or create new courses—by integrating new approaches, techniques, and topics which offer the student an even better learning experience.

## Making Students Want To Learn Giving Students What They Want

Today, computers have provided the technology necessary for Heathkit to create a whole new learning environment which is revolutionizing electronics instruction. With Heathkit software, learning electronics has become more fun, more interesting, more effective, and faster than ever thought possible.

# A Choice of Learning Media

The Most Comprehensive Supplier in the Industry

First, you will not find another supplier that has an extensive line of products to serve both instructor-led situations and individual learning situations.

Secondly, you will not find another supplier whose product offering transcends as many different teaching media — Computer-Aided Instruction, Textbooks, Workbooks, Individual Learning Programs, Videos, Pre-wired Experiment Boards, Parts Packs, Electronics Trainers.

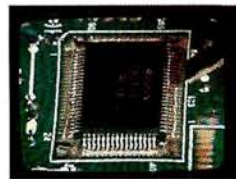

Lastly, we have a breadth and depth of offerings unmatched by any others. We cover more subjects, and offer more choices on how thoroughly you want to cover the various subjects.

Please read on to find descriptions of all of the different courses and learning media available to help you accomplish your goals.

## The Most Effective Learning Method is With Multiple Media Presentations

Our learning package recommendations are based on years of selling to and consulting with instructors, students, curriculum developers, and training directors. The use of multi-media learning packages ensures an attention keeping, interesting and effective

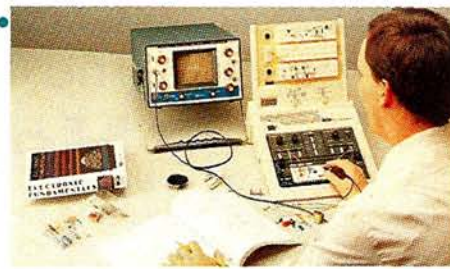

learning experience. Stimulating multiple senses of sight, sound, and touch has proven time and time again to be two to four times more effective than single media approaches. Heathkit training package recommendations ensure your best chances for success.



## Recommended Learning Packages

We recommend learning packages based on whether the application is instructor-led or individualized learning. Although the packages we typically recommend are perfect for many customers, our courses are designed so that they are not inter-dependent. You can select just the right combination of products to suit your needs—and they will all work beautifully together.

### For Instructor-Led Situations:

**Computer-Aided Instruction**  
**Computer-Aided Troubleshooting**  
**Instructor Management System**  
OR  
**Textbook**  
**Workbook**  
**Instructor's Guide**

#### ■ EITHER PRIMARY MEDIA SHOULD INCLUDE:

**Video Tapes**  
**The Appropriate Electronics Trainer with Accessory Backpack**  
**Pre-wired Experiment Boards**

### For Individual Learning Situations:

**Computer-Aided Instruction**  
**Video Tape**  
**Individual Learning Program (The ILP includes an electronics components parts package)**  
**The Appropriate Electronics Trainer**  
(Many students like to add Computer-Aided Troubleshooting to their learning package.)

For Pricing, See Center of Catalog

# Experimentation ■ The Cornerstone of Electronics Training

## Heathkit Invents and Masters the Art

### The Hands-On Experience

Students learn by doing. It's one thing to memorize a concept, but quite another to put it to practical use. That's why electronics trainers used for hands-on experimentation are a key component of every Heathkit learning system.

Students learn basic concepts and theory from computer-aided instruction, textbooks, videotape, and classroom lectures — then bridge the gap from theory to reality — from memorization to understanding — with experiments conducted on rugged Heathkit trainers.

Electronics measuring techniques, soldering methods, circuit and component testing techniques, and of course many many experiments which demonstrate the function of various components and circuits are vital ingredients in successfully mastering electronics.

Heathkit has designed the most student-friendly, easy-to-use, rugged, and safe training equipment in the industry. Our time-tested and proven experimentation methods effectively facilitate the learning process with fun, applications-based, interesting experiments.

### Heathkit offers you a choice to suit your training needs:

With Heathkit trainers, experiments can be built on solderless breadboards, using individual electronic parts supplied by Heathkit — or with time-saving Pre-wired Experiment Boards.

#### 1. Breadboarding with Parts Packs

Generally we recommend the Parts-Pack route for experimentation for individualized learning situations. It is more affordable than pre-wired boards, and, unlike an instructor-led class, there is little need for an individual to inventory and re-use the components many times for several students and for several classes over several years.



For Pricing, See Center of Catalog

#### 2. Pre-Wired Circuit Boards

Responding to the needs of instructors and corporate training directors, we have developed a product to solve a number of problems associated with experimentation using loose electronics components. We have wired the circuits for experimentation onto rugged yet student-friendly circuit boards.



### Why Use Heathkit Pre-wired Experiment Boards?

- **Time is of-the-essence**  
Students get two to four times more hands-on experience in the same amount of time.
- **Many students use the same equipment**  
Our rugged circuit boards are built to withstand years of student abuse.
- **Inventorying loose parts can be a hassle**  
It's a challenge in all classrooms and labs. Parts sometimes get lost, stolen, or put back in the wrong place. Not so with Heathkit's Pre-wired Experiment Boards.
- **Theft of multimeters (which are required if experiments are done using loose parts) is a concern.**  
Our Pre-wired Experiment Boards slide into the Accessory Backpack that has a built-in multimeter.

### A Neater, More Efficient Lab

Heathkit's Pre-wired Experiment Boards are an instructor's and training manager's dream-come-true. It allows a neater, more efficient lab, and enables students to spend less time on non-productive "busywork", and more time actually learning!

Schools and Commercial Accounts, please call your Heathkit Distributor. See page 58.  
Individual Students call Heathkit at 1-800-253-0570

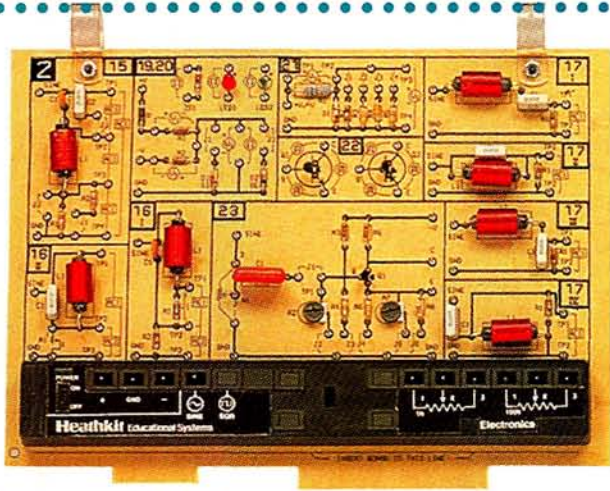

## Designed Right

Heath went the extra mile when designing experiment boards. The entry-level DC & AC boards include not only the experiment blocks—which are numbered for reference to the Lab Workbook—they also display the schematics right on the board next to the real circuit. This helps students make the transition from abstract schematics to real components and real circuits.

Also, Heathkit's unique fault-insertion capability on many boards allow real-world troubleshooting experience without the added expense of computers—as is required by some suppliers.

Pre-Wired Experiment Boards are available for the following Heathkit courses:

DC Electronics	ETB-6101	21 Experiments
AC Electronics	ETB-6102	20 Experiments
Semiconductors	ETB-6103	20 Experiments
Electronic Circuits	ETB-6104-A	45 Experiments
Electronic Fundamentals	ETB-200	20 Experiments
Digital Techniques	ETB-6201-A	40 Experiments
Microprocessor Applications	ETB-6820	21 Experiments
	ETB-8085	19 Experiments

ETB-6104-A  
Electronic Circuits

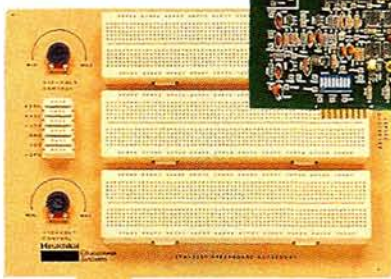
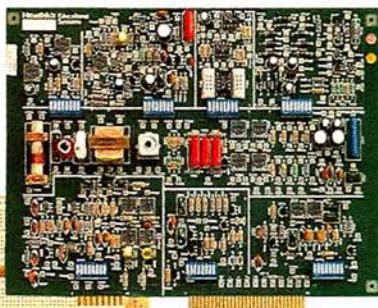

ETB-3300  
Breadboard Circuit Board

**NEW**  
Powerful  
Classroom-Ready



## The New Heathkit PC Trainer

Heathkit's new, powerful PC Trainer is classroom-ready using both its own fault insertion module, and the special course-specific fault insertion modules that come with each of the three new courses—**PC Servicing, PC Troubleshooting, and PC Networking**. These new in-depth "PC Literacy" courses are unlike any you've ever seen—and make it easier than ever to provide students with the skills they need in the job market of today and tomorrow. See pages 40 through 45 for complete course and equipment descriptions.

## ETW-3567 Accessory Backpack

Required when using Pre-wired Experiment Boards, the Accessory Backpack simply attaches to the back of any one of our three most popular trainers (ETW-3600, ETW-3700, & ETW-3800).

### Specifications

#### Power Supplies

Output Voltages: +1.2 to +15 volts DC, programmable  
-1.2 to -15 volts DC, programmable (current output 250 mA at 15 volts)+ 5 volts DC @ 500mA

Load Regulation: better than 2% (all supplies)

Line Regulation: better than 1% (all supplies)

Digital Voltmeter (DVM)

Input Impedance: 10 megohms

Display: 3 1/2 digit, liquid crystal display (LCD)

Function: AC volts, DC volts, DC current, resistance

Ranges: AC volts - 200, 500 VAC

DC volts - 2, 20, 200, 500 volts DC

DC current -2, 20, or 200 mA

Resistance: -2k, 20k, 200k or 2 megohms Accuracy: AC volts -

2% of reading, + 3 counts (ref'd. to 60 Hz) DC volts -1.5% of

reading, + 2 counts DC current - 2.5% of reading, + 2 counts

Resistance: -1% of reading, + 2 counts

Maximum Inputs: AC and DC - 500 volts DC current - 200 mA

#### General

Fuses: power supply - 1/4-A slow-blow 120V, digital voltmeter - 1/4-A

Dimensions: 14"H x 12"W x 4"D (35.6 x 30.5 x 10.2 cm)

Built-in Speaker

# Heathkit Where You Have A Choice



## Classroom Textbooks, Workbooks, & Instructor Guides

### Developed by World Leaders in Electronics Technology

When it comes to electronics courses, it pays to select Heathkit. We are not just another publisher of training books—we are experts in education and specifically—*electronics!*

### Textbooks Unlike Any Others – Addictive to Instructors

Heathkit electronics textbooks have been successfully used year after year by thousands of schools and by hundreds of thousands of students. Our no-nonsense approach to teaching—using easy-to-understand language and straight-forward explanations—is appreciated by instructor and student alike. It's simple, if the instructors are not successful with a textbook, they find another one. Yet once they use Heathkit texts, they seem to never stray.



### Proven Effective in Real-World, Hands-On Learning

The sheer nature of electronics is one in which concepts must be demonstrated and visually reinforced. And no one has had more experience in demonstrating electronics principles than Heathkit. In fact, we consider it both an art and a proprietary science.

### Instructor Guides That Save Countless Hours

Responding to the fact that teachers are being demanded to teach more topics to more students with less time, Heathkit supplies an invaluable tool to help manage your classroom. Written by educators with the inputs of many instructors, you can feel confident that these guides will make your job of preparing for class a whole lot easier.

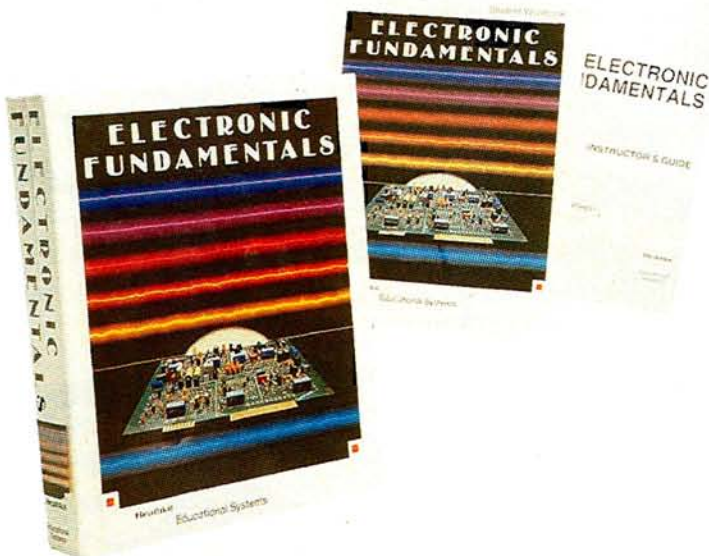

For Pricing, See Center of Catalog

8

Schools and Commercial Accounts, please call your Heathkit Distributor. See page 58. Individual Students call Heathkit at 1-800-253-0570



Great for Individual, Industrial and Adult Education.  
Some Instructors Even Prefer This Teaching Method In Classrooms.



# Individual Learning Programs (ILP)

## If You Can't Go To The Knowledge, Let The Knowledge Come To You

School isn't for everyone. Nor is an instructor-led classroom always the most practical way to get an education. We have a time-tested and proven alternative to getting the information and training you need—our exclusive Individual Learning Programs:

## Quality and Comprehensive

Our Individual Learning Programs convey the same knowledge as do our textbooks and workbooks—which are used in many of the most prestigious schools. Yet, since classrooms are paced by the class itself, often-times an instructor can not get through all the material. Not so when you embark on an Individual Learning adventure with Heathkit. You decide when and how much time to devote to “classroom” and “laboratory.” We provide you with quality tools and instruction enabling *you* to build the skills *you* need to achieve *your* goals.

- 400 to 1000 pages of fast-paced text
- Complete Electronics Parts Package to apply concepts to real circuits
- Course Review Disk to use with a computer if you have one
- Grading Service
- Private One-on-One Instructor Assistance
- The option of saving money and enhancing your learning experience by building your own electronics trainer from a kit
- Continuing Education Units of credit
- Guarantee of Satisfaction! If at any time you are not satisfied with the education you are getting, you can return the Individual Learning Program for a full refund!

All together, that's quite a value compared to any alternative on earth.

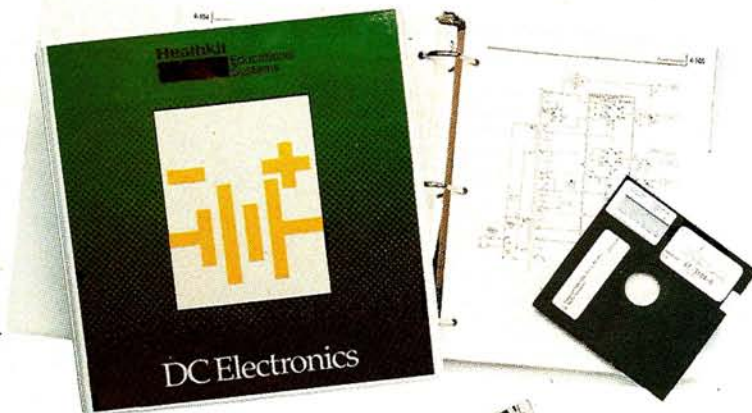

## Instructor Help is Just a Call Away

If you need help with a concept or with one of the fascinating hands-on experiments, just call one of our instructors for help to get you back on track—and it doesn't cost you a penny more. (616) 925-4914 Mon-Fri 8:00am to 4:30pm eastern time.

## Diploma's, CEU's and Services

When you pass your final exam, you are awarded a beautiful diploma and Continuing Education Units (CEU's.) Plus, we keep records so you can always get a transcript for only one dollar.

## Required Equipment

All our Individual Learning Programs require the use of an Electronics Trainer (pages 16-19), a Multimeter, and an Oscilloscope (pages 54& 55.) The only exceptions are DC Electronics, Concepts of Electricity, and Laser Technology which do not require an oscilloscope.

## Courses Available For Most Subjects

See pages 20—53 for course descriptions. Look at the bottom of each page for the **Individual Learning** designation and course numbers.

## Enhance Your Learning Experience...

with the addition of our high-speed, graphics-intensive Computer-Aided Instruction courses, and video courses (see pages 10 -15.)

# Heathkit, The Most Impressive Computer-Aided Instruction (CAI) Available

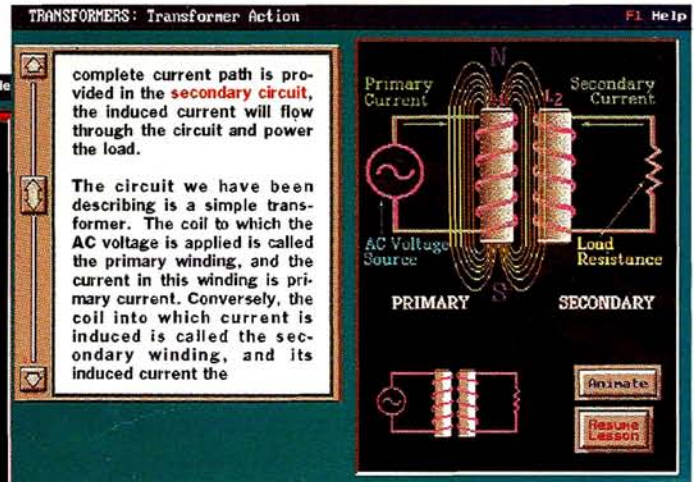
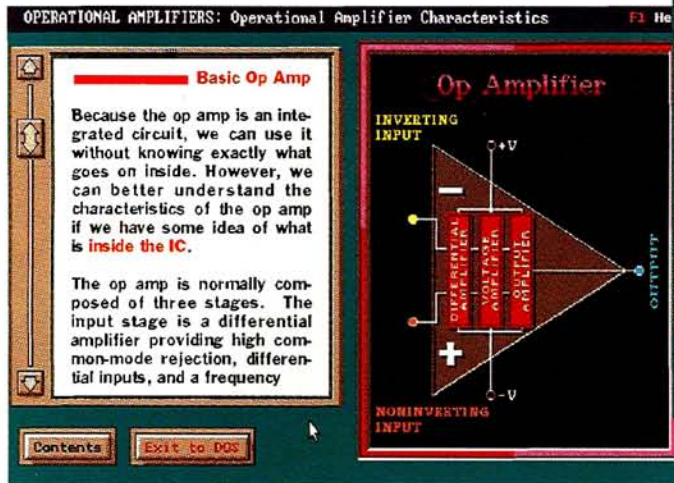

## Fast, Effective, State-Of-the-Art Learning

We combined our legacy of easy-to-learn and easy-to-teach electronics education methods with the power, timeliness, and versatility of the computer. Unlike others, we didn't skimp when it came to using razor-sharp, interactive color graphics to dramatically demonstrate three-dimensional electronics concepts.

Using a mouse, students interact with dynamic illustrations and demonstrations. This makes learning fun and fosters student interest and success.

Computer-Aided Instruction captures and maintains students' attention. In classrooms, you may even have to drag students away from their computers at the end of the class. At home you may lose some sleep while having so much fun learning.

## Smart Quizzes = Faster Learning

Self-testing—including immediate positive reinforcement graphics—helps assure that fundamentals are understood before progressing to new concepts.

Each quiz awaits a correct response before allowing the student to progress through the chapter. Plus, multiple-choice answers are rearranged after

incorrect responses, and calculation problems use randomly selected values—all to inhibit the process of elimination. The immediate positive feedback, or prompting to restudy the appropriate text, encourages students to learn more quickly.

## CAI-LITE and CAI-ExTra

CAI-LITE is our basic computer-aided instruction. It is a complete educational package that is not lite at all in terms of its content and effectiveness. It was designed for the individual student in a work training program, home study, or to augment a formal classroom lesson plan.

Mechanically, a "key disk" must always be in a floppy drive in order to progress through the course. Because CAI-LITE is often taken as a self-study course, it includes

a final exam grading service, and if passed, a certificate of achievement and awarded CEUs.

CAI-ExTra takes CAI-LITE and integrates Experiments, Tracking, and customizing capabilities. Experiment descriptions, graphics, and directions are integrated into the program. The experiments correspond to those supported by our series of Pre-wired Experiment Boards.

Secondly, this program, along with the Instructor Management System (page 14), allows an instructor a fully-automated, menu-driven record-keeping system that provides easy access to

*"MY STUDENTS WERE SO INTRIGUED WITH THE PROGRAM, THAT WHEN I ENTERED THE LAB AREA, YOU COULD HAVE HEARD A PIN DROP — AND WE HAVE CARPET ON THE FLOORS!"*

Karen Reeves, Electronics Instructor, GA

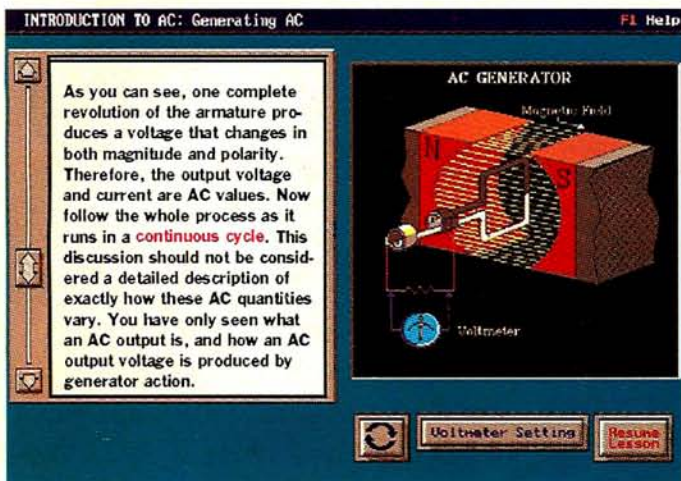

each student's experiment trail, quiz scores, exam answers and grades, and completion times.

In addition, instructors can alter chapter sequencing, make experiments either required or optional, and even easily go into the program and alter, add, or subtract text to meet their changing requirements.

Because CAI-ExTra is designed for instructor-managed situations, grading services, certificates, and CEUs are not included.

## Easy for the Student & Instructor

The user's guide is very "instructor and user-friendly." Easy-to-understand installation and operating instructions, screen reproductions of quiz graphics, and answers to all quizzes provide everything you need in a concise User's Guide.

*I'VE BEEN TEACHING ELECTRONICS FOR FIFTEEN YEARS. NOW THAT I'M USING HEATHKIT COMPUTER-AIDED INSTRUCTION, MY STUDENTS ARE FINALLY LEARNING SOMETHING*  
 Russ Swallow, Electronics Instructor, Nevada

## Additional Features

- A Hypertext Glossary where all key terms are highlighted so definitions can be instantly accessed by selecting the word.
- An instantly accessible on-screen multi-function calculator is included in all courses.
- Can be utilized "stand-alone," or comprehensively with our EB-6100 series textbooks. The experiments correspond with our EB-6100 series texts and ETB-6100 series Pre-wired Experiment Boards.
- A single text, Heathkit EB-200, is a great supporting textbook for classrooms.
- CAI-LITE is also a perfect compliment to our Individual Learning Programs.

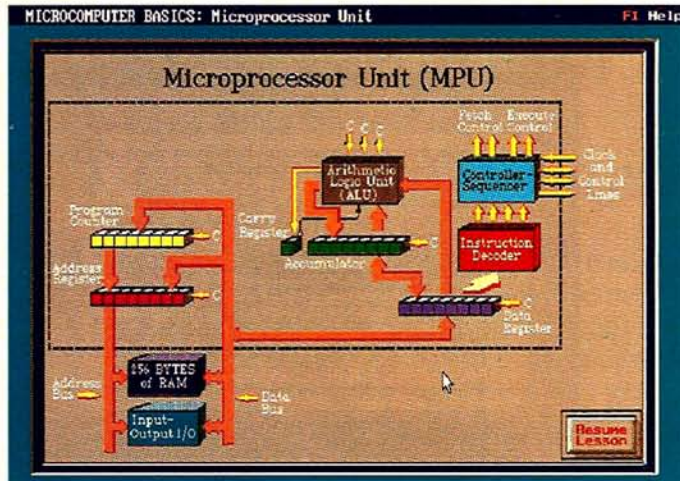

- Since instructors can elect to make experiments optional, Heathkit CAI can be used with any electronics training hardware from any manufacturer.
- Each course is designed for between 20 and 40 hours of instruction.

## Student Preferred

In head-to-head competition with our only serious competitor, Heathkit won hands down! Let yourself or your students be the judge.

## Demonstration Packages Available

Heathkit CAI is so impressive, it's impossible to fully appreciate what it can do for you and your students without seeing it first-hand.

That's why we offer a demonstration package of CAI-ExTra to schools and commercial accounts. Please call your Heathkit distributor for a free, no-obligation demonstration.

For individuals, simply give CAI-LITE a test drive at home for up to 30 days. If you're not thrilled with it, you may return it for a full refund. Call today.

## Subjects Available in This Media:

(See pages 20-37 for course descriptions)

Subject	CAI-ExTra	CAI-LITE
DC Electronics	CAI-6101-02	EEC-3101-03/05
AC Electronics	CAI-6102-02	EEC-3102-03/05
Semiconductors	CAI-6103-02	EEC-3103-03/05
Electronic Circuits	CAI-6104-02	EEC-3104-03/05
Digital Techniques	CAI-6201-01	EEC-3201-03/05
Microprocessors	CAI-6810-01*	EEC-3401-03/05*
Instructor Mgmt Sys.	CAI-6100/-03	Not Applicable

\*This model will be available in the spring of 1994

## Troubleshooting Revolution!

### Fundamentally Necessary

Electronics training isn't really complete unless students know how to troubleshoot. That's why troubleshooting has to be an integral part of any electronics curriculum. In fact, it's one of the most important skills that electronics technicians and engineers use in the field. But until now, troubleshooting has always been a difficult and expensive ... time-consuming and unorganized subject to teach.

### A New Approach - Easier, More Effective

Now, Heathkit — the leader in teaching real-world troubleshooting — is proud to introduce a completely unprecedented approach to teaching troubleshooting. An approach which forges our historically-proven teaching methods with the speed, power, and motivational capabilities of the computer.

Yet, this system is so low cost ... so fast for the instructor and student ... so intuitive and effective ... and so integrated with whatever curriculum you're using ... it's destined to be the way all troubleshooting is taught in the future.

### Here's an example of how it works:

In a series of simulations, the student becomes a technician called to a work site. The simulations show the faulty device, and the necessary test instruments, tools, schematics, and spare parts needed to find and fix the problem.

The students interact with the simulations, measuring voltage and resistance, looking at wave shapes, removing and testing components — just as they would in the real world, but in complete safety and at ten times the speed.

Each course includes a simulated digital multimeter, soldering iron, instant component swap-

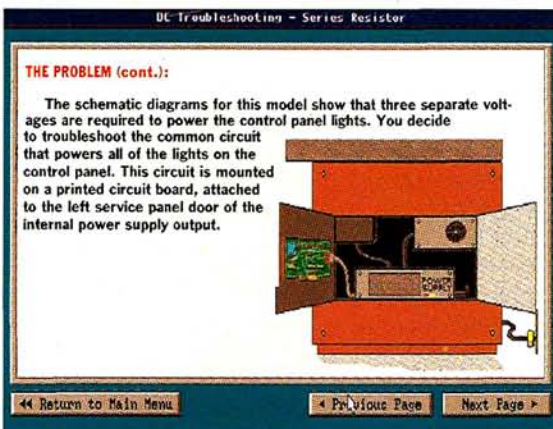
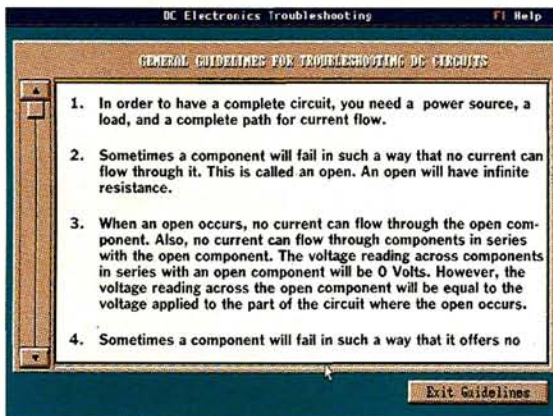

ping capability, and where applicable, a signal generator and oscilloscope.

## Friendly to the Student and Instructor Alike

Additional features that enhance the effectiveness of Heathkit computer-aided troubleshooting is a detailed HELP screen accessible anywhere in the program, three different "tutoring hints" available for each problem, and instant switching between the component view and schematic view of the circuit.

And we've made it so that the computer inserts the random faults rather than taking up instructor time. Then, grading is a snap. The computer keeps track of every step, every measurement, and every test made by the student allowing the instructor to analyze and grade the technique of the student.

## Teaching the Techniques is What it's All About

Anyone can fix a circuit given enough time and spare parts, but learning a proper technique is really the essence of electronics troubleshooting. Heathkit computer-aided troubleshooting was designed from the ground up to accomplish this mission.

## Take a Test Drive

This all-new approach to troubleshooting instruction will become one of your most powerful teaching tools. For schools and commercial accounts, your Heathkit Educational Systems distributor will be pleased to provide you with a free, no-obligation demonstration. Call today.

Although designed such that an instructor evaluates a student's *technique*, if an individual is disciplined and follows the instructions, they too can benefit tremendously from these courses. Give it a test drive at home for up to 30 days. If you're not thrilled with it, you may return it for a full refund. Call today.

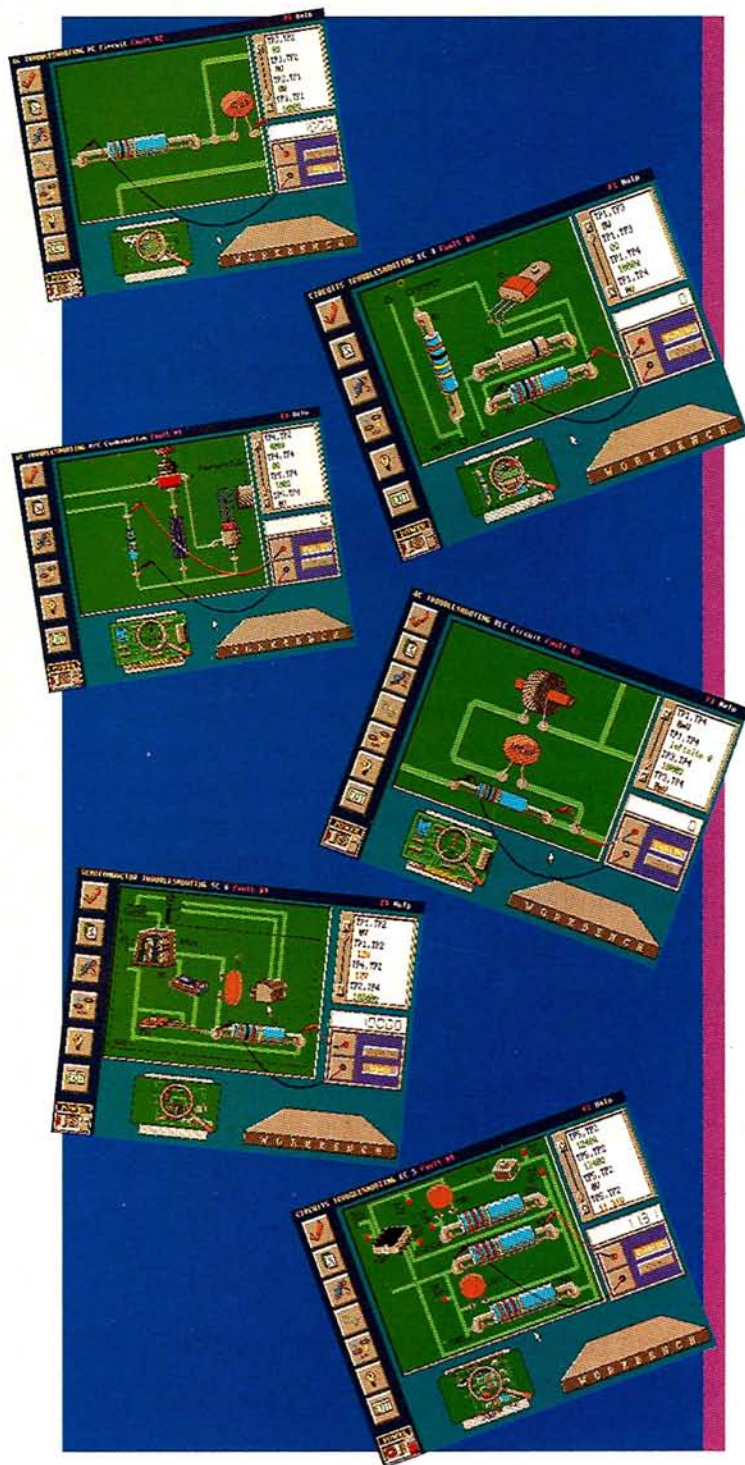

## Subjects Available in this Media

DC Electronics	CAT-6101-01
AC Electronics	CAT-6102-01
Semiconductors	CAT 6103-01
Electronic Circuits	CAT-6104-01
Instructor Management System	CAI-6100/03

For Pricing, See Center of Catalog

# Instructor Management System for Computer-Aided Instruction

# CAI

## An Instructor's Dream

As we started developing our Computer-Aided Instruction courses, we recognized a tremendous opportunity for class management - and a huge leap forward for instructors. Managing your class and evaluating your students can be much more effective and convenient than ever before - and, it's very easy for instructors to use.

## Good Bye to Piles of Paper

Heathkit's Instructor Management System is a fully automated, menu-driven record-keeping system that gives you easy access to each student's quiz scores, exam answers and grades, and completion times. It tells you exactly how each student proceeded through every lab exercise, troubleshooting experience, and exam. View all or any part of the student records on-screen with multi-color bar graphs, or press a button and print out details or summaries.

With our Instructor Management System, you control the learning process with quick access to each step your students take. You can read student workdisks in just a few seconds. Of course the program handles all the calculations automatically. If a student loses or damages a disk, you can easily restore one. Unlike the inferior programs out there, you, the instructor, decides the right time for "activating" the final exam for each student.

CAI-6100 5.25" disks

CAI-6100-03 3.5" disks

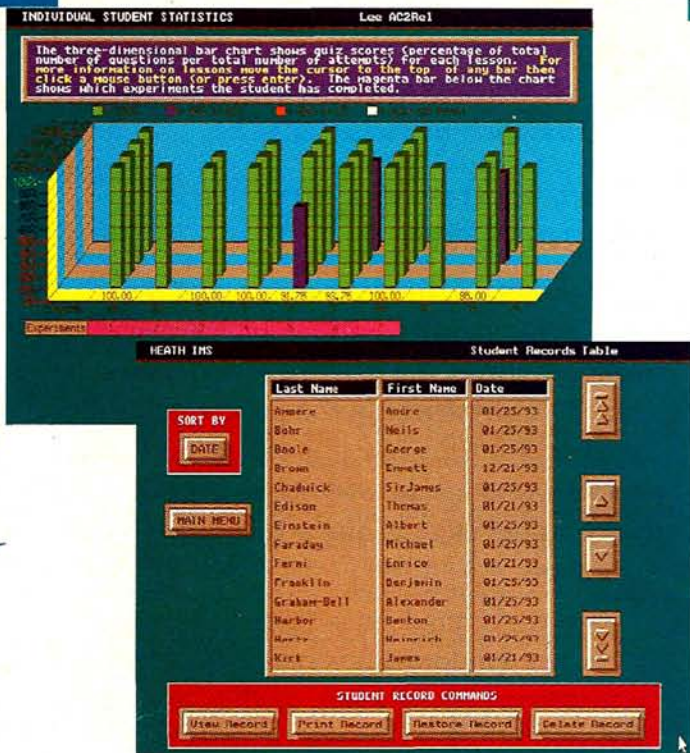

## Power Supplies

Virtually every electronic device has a power supply of some type. This 25-minute video covers detailed theory and troubleshooting of linear power supplies commonly found in consumer products. Plus, it covers discrete and integrated circuit designs. A student workbook helps reinforce what's learned in the video. **EV-3113**

## Switching Power Supplies

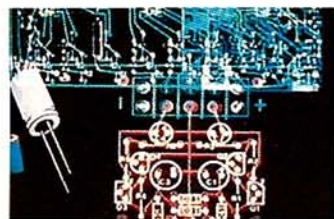

Because of their many advantages, switching power supplies are increasingly popular in a wide variety of products including the personal computer. This 22-minute video teaches you the operation of this sophisticated circuit. Emphasis is on real-world products and situations. You'll analyze theory and operating principles and describe troubleshooting, service and safety precautions in detail. A student workbook is included. **EV-3114**

# Videos

See pages 20 – 37 for videos on DC, AC, Semiconductors, Electronic Circuits, Digital Techniques & Microprocessors

There is no replacement yet for the thoroughness of textbooks, but video does offer the advantages of being able to show motion through animation and live recording. Plus thousands of pictures are shown rather than

dozens found in books. Bottom line is that video is a very powerful and effective training tool—and well-received by students—which solves a major challenge in-and-of-itself.

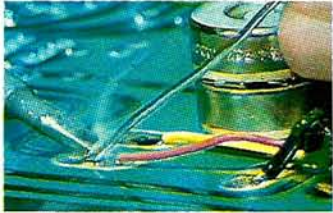

## Soldering

Students learn to solder the easy way by watching how it's done in this 40-minute video.

Teaches the chemical functions of solder, oxidation and flux, mechanical connections, tinning, temperature control and the types of solder to use. Covers how to make good solder connections and recognize and repair bad ones. It even covers how to select and clean your soldering tools. Includes a student workbook to reinforce what's learned. **EV-3133-A**

## Component Recognition

A must for every beginner in electronics, this 40-minute video on Component Recognition introduces resistors, capacitors, inductors, diodes, transistors, integrated circuits and more. Students learn to read the electrical values of each component and describe power handling capabilities, prefixes, polarity, and orientation of transistors and ICs. A section on troubleshooting shows you how to find common installation errors. Safety is also emphasized. Includes student workbook to reinforce what you learn. **EV-3135-A**

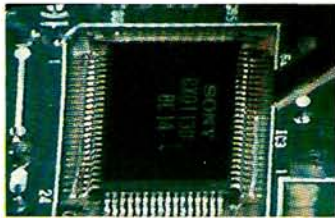
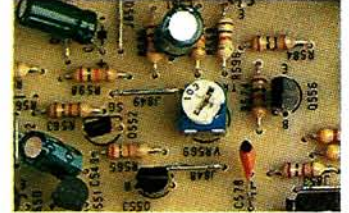

## High Reliability and Surface-Mount Soldering

Surface Mount Devices (SMDs) are becoming increasingly popular in today's micro-electronic equipment because they allow much tighter component densities than conventional technologies. Very specialized soldering techniques and tools are required in the repair of equipment that use SMDs. This exciting, new 30-minute video tape will teach you these techniques in record time. You will learn how to select and use a variety of special soldering and de-soldering tools. You will also learn the proper techniques for removing and replacing SMD components. Includes a student workbook to reinforce learning. **EV-3136**

## Op-amp Circuits

Because of their versatility and low cost, operational amplifiers are the workhorses of analog electronics. This 30-minute video takes you inside the operational amplifier circuit. You'll actually see how op-amps work and how they are used as amplifiers and comparators in control circuits and in other applications. Biasing and power supply requirements are also shown. Includes student workbook to compliment the video. **EV-3112**

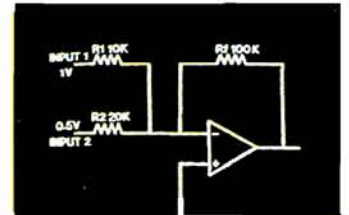

## Troubleshooting with the Oscilloscope



The oscilloscope is the most flexible and important test instrument available. This 45-minute video shows you the proper techniques for using the oscilloscope to troubleshoot a wide variety of today's complex hi-tech products. It shows how to measure and analyze voltage, signal levels, waveforms and frequencies. A student

workbook is included to reinforce what's learned in the video. **EV-3110**

## Troubleshooting with electronic test equipment

This 22-minute video teaches troubleshooting with the NTSC generator, Multi-channel TV Sound (MTS) generator, sweep generator, DVM, stereo generator and frequency counter. Students review the proper use of isolation transformers and procedures for safety leakage tests. Plus, diagnostic techniques for consumer electronics are covered. A student workbook is included to reinforce what's learned. **EV-3111**



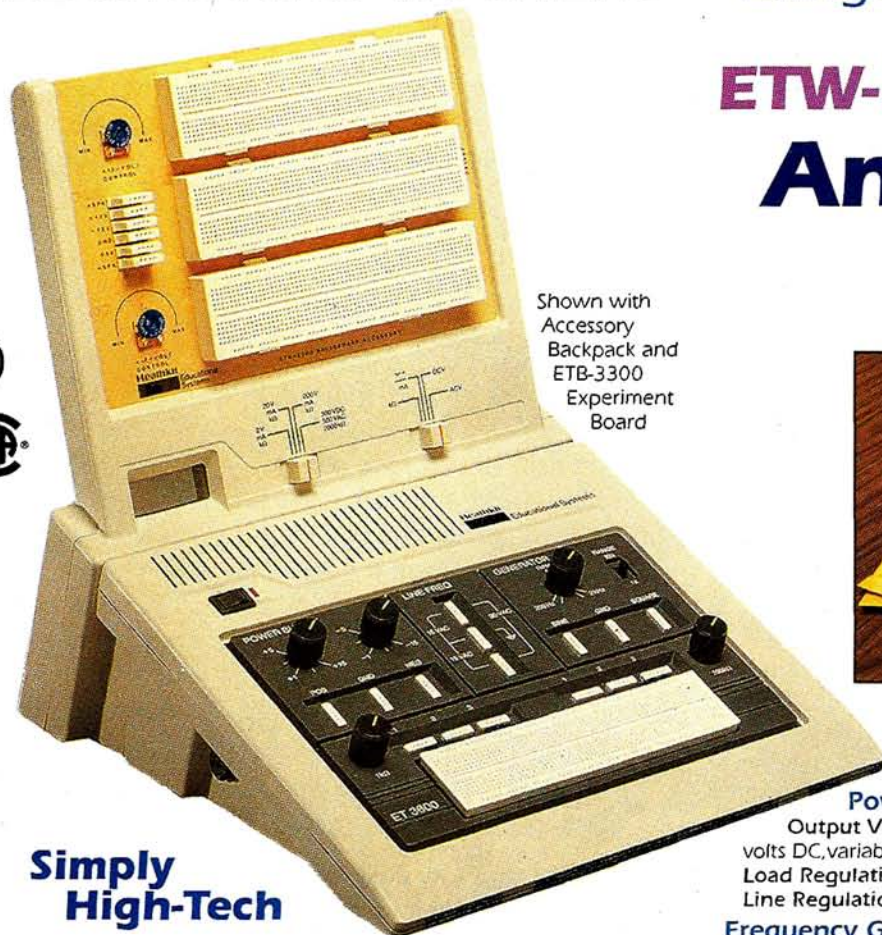

Shown with  
Accessory  
Backpack and  
ETB-3300  
Experiment  
Board

## ETW-3600 Analog Trainer



### Simply High-Tech

Experimentation with live circuitry is an essential ingredient in all electronics training programs. Heathkit's trainers empower you to get the hands-on experience with real circuits that you need to master electronics.

You'll see abstract electronics concepts come to life as you perform dozens of exciting experiments. The ETW-3600 trainer features a removable solderless breadboard for easy circuit building—plus it allows more than one student to build circuits at the same time.

This powerful trainer accepts up to #20 wire and almost any standard electrical component. Its connector blocks are recessed for extra durability, and the power supply is protected against short circuits and overloads.

Use the ETW-3600 alone with Parts Pack experiments, or attach the Backpack Accessory and use our time-saving, Pre-wired Experiment Boards.

- ETW-3600 Analog Trainer
- ET-3600 Analog Trainer (kit)
- ETA-3600-1 Extra Breadboard Block

.....  
**Specifications**

#### Power Supplies

Output Voltages: + 1.2 to 15 volts DC, variable; -1.2 to -15 volts DC, variable (current output 250mA at 15 volts)  
Load Regulation: better than 2% (from 5-15 volts)  
Line Regulation: 1% (Supplies are short-circuit/overload protected.)

#### Frequency Generator

Range Selector Switch: LOW position — 200-2000 Hz, continuously variable HIGH position — 2-20 kHz, continuously variable  
Frequency Calibration: 12% of maximum range  
Sine Wave Output: 5 volts rms @ less than 4% distortion  
Square Wave Output: 15 volts peak-to-peak (+15 volts max); rise time less than 1 microsecond; nominal duty cycle of 45% to 55%

#### 60 Hz Sine Wave Output

Output Voltage: 15 and 30 volts rms  
Current: 200 mA maximum

#### General

Solderless Breadboard Block: removable, 130 rows, 4 terminals  
Power Reqs: 105-130 VAC, 60 Hz @ 15 watts  
Fuse: 1/4-A slow-blow @ 120 VAC  
Dimensions: 4.3" H x 12" W x 11.4" D (10.8 x 30.5 x 28.9cm)  
Net Weight: 6 lbs. (2.3 kg)

### Courses Requiring the ETW-3600

#### Concepts of Electronics

EB-6140 (Text), EE-3140-A (ILP)

#### Electronic Fundamentals

EB-200 (Text)

#### DC Electronics

EB-6101-A (Text), EE-3101-B (ILP), CAI-6101-02 (CAI)

#### AC Electronics

EB-6102-A (Text), EE-3102-B (ILP), CAI-6102-02 (CAI)

#### Semiconductor Devices

EB-6103-A (Text), EE-3103-B (ILP), CAI-6103-02 (CAI)

#### Electronic Circuits

EB-6104-A (Text), EE-3104-B (ILP), CAI-6104-02 (CAI)

#### Electronic Test Equipment

EB-6105 (Text), EE-3105-A (ILP)

#### Electronic Communications

EB-6106 (Text), EE-3106-A (ILP)



# ETW-3700

# Digital Trainer

Shown with  
Accessory  
Backpack and Pre-  
wired Experiment  
Board



## Ruggedly Sophisticated

Provide yourself or your students valuable hands-on experience building digital circuits. The versatile ETW-3700 Digital Trainer speeds and simplifies digital circuit design and experimentation. It enables you to apply course material in a practical way, through experiments and by building and testing your own prototypes.

Features include 3 built-in short-circuit and overload-protected regulated power supplies: positive and negative 12-volt DC and positive 5-volt DC voltages to power both digital and linear circuits. Supplies a line-frequency square wave (60 Hz), a three range clock, and a great deal more. Compact and portable, the Digital Trainer is a solid piece of equipment that keeps working for years and years. In classrooms, students will use it to build, test, reconfigure and rebuild experimental circuits literally thousands of times.

Like our Analog Trainer, the Heathkit Digital Trainer also has a removable solderless breadboard that accepts solid wire up to #20 and the leads from nearly every common electronic component. The connector blocks are recessed for extra durability. Use the ETW-3700 alone with Parts Pack experiments, or attach the Backpack Accessory and use our time-saving, Pre-wired Experiment Boards.

**ETW-3700** Digital Trainer  
**ET-3700** Digital Trainer (kit)  
**ETA-3600-1** Extra Breadboard Block

## Specifications

### Power Supplies

Output Voltages: +12 volts DC @ 250mA, -12 volts DC @ 250mA, +5 volts DC @ 500mA.  
Load Regulation: +5 volts DC supply — better than 5%, +12 and -12 volts, DC supplies — better than 1%.  
Line Regulation: 1% (All supplies are short-circuit and overload protected.)

### Data Switches

States: +5 or 0 volts DC  
Maximum Current: 10-mA each switch  
Output: four terminals for each switch

### Logic Switches

Number: two  
Type: momentary contact, spring-loaded  
Circuit: two flip-flop latches for contact bounce buffering  
Output States: complementary, +5 and +0.2 volts DC

### Clock

Frequency Selection: 3-position slide switch  
Output Frequency: 1 Hz, 1kHz, 100 kHz  
Duty Cycle: 35% to 65%  
Output Voltage: 5 volts peak-to-peak (no load)  
Output Terminals: normal and complement  
Logic Indicators: four green LEDs with separate input terminals  
Low level (OFF) 1.0 V (maximum), High level (ON) 3.0 V (minimum), input terminals able to withstand + 12VDC, TTL compatible.

### General

Solderless Breadboard Block: removable, 130 rows of four terminals each  
Line Source: 50/60 Hz  
Power Requirements: 105-130 VAC, 60 Hz @ 20 watts max  
Fuse: 1/4-A slow-blow @ 120 VAC  
Dimensions: 4.3" H X 12" W X 11.4" D (11 X 31 X 29 cm)  
Net Weight: 6 lbs. (2.3 kg)

## Courses Requiring the ETW-3700

### Digital Techniques

EB-6201-A (Text), EE-3201-A (ILP), CAI-6201-01 (CAI)

For Pricing, See Center of Catalog

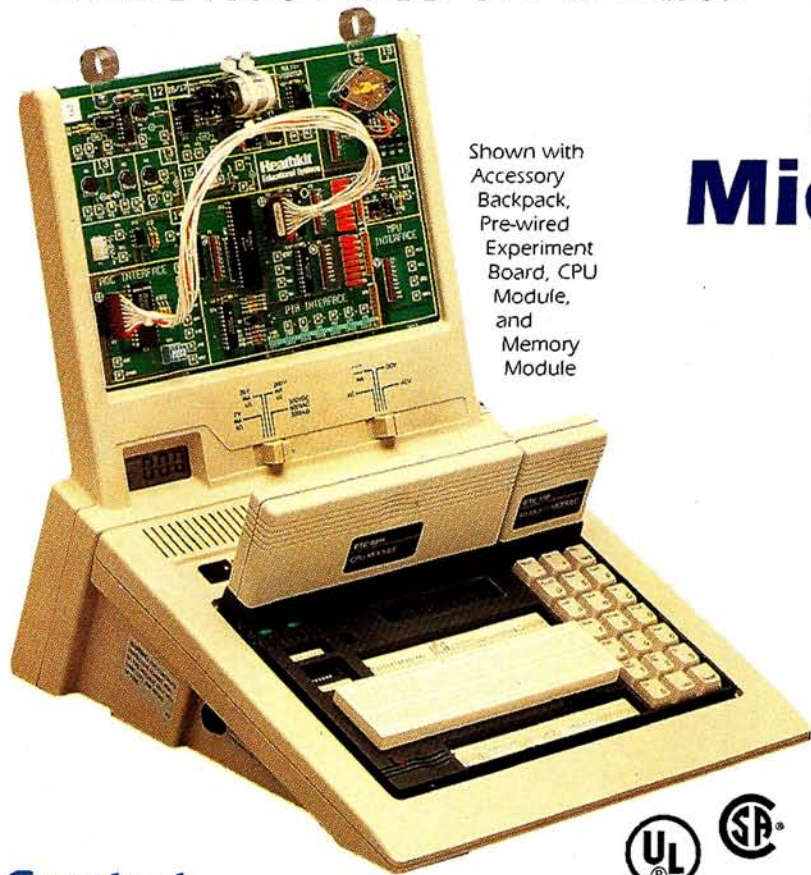

Shown with  
Accessory  
Backpack,  
Pre-wired  
Experiment  
Board, CPU  
Module,  
and  
Memory  
Module

## ETW-3800 Microprocessor Trainer

### Additional Features:

- 20 x 2 line LCD panel for alphanumeric displays
- 21-key hexpad and advanced software to facilitate easy programming
- Built-in sonic logic probe for checking signals visually and audibly
- Socket for ROM or E<sup>2</sup> PROM allows students to save programs
- Built-in Dis-Assembler
  - CPU module features 8-channel A/D and single D/A line
  - CPU module has multi-function programmable timers

Use the ETW-3800 alone with Parts Pack experiments, or attach the Backpack Accessory and use our time-saving, Pre-wired Experiment Boards.

ETW-3800	Microprocessor Trainer
ETC-6811	68HC11 CPU Module
ETC-8085	8085 CPU Module
ETA-3600-01	Extra Breadboard Block
ETC-128	Memory Module

### Greatest Invention Since the Transistor

Microprocessors revolutionized the world of electronics much the same way as did the transistor and IC (integrated circuit.) No one's electronics education is complete without a thorough knowledge of microprocessors.

### One Trainer, Multiple Microprocessors

This rugged trainer can be used to teach the two most popular 8-bit microprocessor families simply by switching plug-in CPU modules. Plug in the ETC-6811 CPU Module, and use it to teach the Motorola family of MPUs. Or plug in the ETC-8085 CPU Module and teach the Intel family. The ETW-3800 Microprocessor Trainer is the perfect tool for learning programming, interfacing, and applications.

### Rugged Design

The ETW-3800 features heavy-duty connectors, recessed connector blocks, and built-in short circuit protection. The trainer is virtually student-proof, but is still user-friendly.

### Features RS-232 Port

Allows this trainer to interface with terminals or computers so you can easily download programs from a PC.

### Specifications

#### Power Supplies

Output Voltages: +5 volts DC @ 0.5 A; +12 volts DC @ 0.1 A;  
-12 volts DC @ 0.1 A  
Load Regulation: 5%  
Power-Off Data Retention: 1 hour minimum

#### Logic Probe

Logic High: >2.0 volts  
Logic Low: <0.8 volts  
Minimum Glitch Recognition: 50 MHz  
Visible Output: red, green LEDs  
Audible Output (with Disable): 1.8 kHz, 2.2 kHz

#### General

Dimensions: 7"H x 12"W x 11"D (17.8 x 30.5 x 27.9 cm)  
Weight: 6.2 lbs (2.81 kg)  
Power Requirements: 115 VAC, 60 Hz

### Courses Requiring the ETW-3800

#### 68HC11 Programming

EB-6810 (Text), CAI-6810-01 (CAI)

#### 68HC11 Interfacing and Applications

EB-6820 (Text)

#### 8085 Programming

EB-8085 (Text), CAI-8085-01 (CAI)

#### 8085 Interfacing and Applications

EBI-8085 (Text)



## ETW-3400-A

# Microprocessor Trainer

### World's Most Popular Microprocessor Trainer!

Preferred by virtually every microprocessor text on the market, this flexible, general-purpose trainer can be used anywhere you need a microprocessor-based software development system. It can also be used as a design aid for developing custom interface circuitry. Supports hands-on experiments for microprocessor programming, interfacing, and applications.

The ETW-3400-A is built around the popular 6808 microprocessor and has 512 bytes of user-accessible RAM and a 1K monitor ROM. It features a solderless breadboard that lets you build prototype logic circuitry plus a 17-key hexadecimal-based keypad and six 7-segment LED display digits for easy data entry, data review and troubleshooting. UL listed. Requires 120 VAC,



60 Hz at 30  
watts maximum power.  
Dimensions are 3.5" H x 12.1" W x 11.8" D.

**ETW-3400-A Microprocessor Trainer**  
**ET-3400-A Microprocessor Trainer (kit)**

### Courses Requiring the ETW-3400-A

#### Microprocessor Programming

EB-6401-A (text), EE-3401-A (ILP)

#### Microprocessor Interfacing

EB-6402 (text), EE-3402 (ILP)

#### Microprocessor Applications

EB-6405 (text), EE-3405 (ILP)



## ETW-1000

# Analog/Digital Trainer

square, triangle and pulse waveforms from 1 Hz to 100 KHz in five switch-selectable/variable ranges, plus a built-in logic probe.

Other features include two "no-bounce" logic switches, variable 1k and 100k ohm resistors, eight switches for selecting logic lows or highs, and eight LED logic-state indicators. Even with all these features, the ETW-1000 is still a compact 5" H x 16" W x 11" D. UL listed. Uses 120 VAC at 60 Hz.

**ETW-1000 Analog/Digital Trainer**

**ET-1000 Analog/Digital Trainer (kit)**

**ET-1000-01 Extra Breadboard Block**

### Two Trainers in One

This powerful trainer is a genuine mini-lab that provides hands-on experience building and testing prototype circuits. It features two removable solderless breadboards and solderless connector blocks for quick, easy circuit assembly and testing. It also includes variable and regulated positive and negative DC power supplies, a built-in function generator for producing sine,

### Courses Requiring the ETW-1000

#### Data Communications & Networks

EB-8090 (text), EE-8090 (ILP)

# DC ELECTRONICS COURSES

With the Heathkit DC Electronics courses, students quickly and easily develop a working knowledge of the basic principles of electronics. This course doesn't just cover concepts, but prepares students for all kinds of applications as well. Highlights include learning the purpose and operation of such devices as resistors, capacitors, inductors and meters.

Students learn to construct DC circuits, draw schematic diagrams, and define and solve basic electronic problems related to current, voltage, resistance and power. Actual hands-on experience is provided with 21 different exciting experiments using dozens of electronic components. Each new experiment helps develop understanding, ability and confidence.

Course Objectives (Varies slightly depending on media selected)

## COMPUTER-AIDED INSTRUCTION

CAI-6101-02 (CAI-ExTra)

EEC-3101-03 (CAI-LITE, 1 CEU)

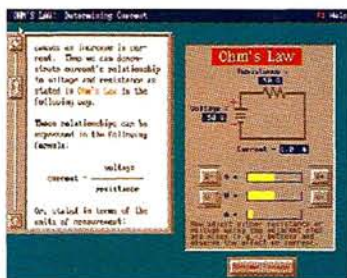

## DC ELECTRONICS COURSE

EB-6101-A (Instructor-Led)

EE-3101-B (Individual Learning, 2 CEU's)



## DC ELECTRONICS VIDEO

EV-3101-A

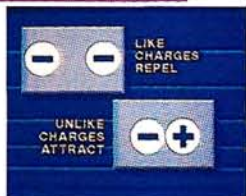

## COMPUTER-AIDED TROUBLESHOOTING

CAT-6101-01



### Current

- Define the following terms: direct current (DC), molecule, element, compound, atom, proton, neutron, electron, nucleus, ion, coulomb, ampere, conductor, insulator, valence, current, directed drift, battery polarity, balanced state, neutral state, normal state, electrostatic induction, short-circuit, open-circuit.
- State Coulomb's Law and the effects of behavior of like and unlike charges.
- State the electrical charge that is associated with the following: Atom, electron, proton, neutron, nucleus, and ion.
- Given a diagram of Bohr's atomic model, identify the three basic particles.
- Name the three basic parts of an electrical circuit.
- Given a schematic diagram, indicate the direction of current flow.
- Draw a schematic of a circuit using the resistor, battery, and conductor schematic symbols.
- State the correct method for connecting an ammeter in a circuit.
- Identify materials most likely to become positive or negative ions.

### Voltage

- Define the following terms: electromotive force, potential difference, voltage, volt, cell, primary cell, secondary cell, voltage drop and rise, ground, short, open, battery, alternating current (AC), triboelectric effect, thermoelectric effect, piezoelectric effect, and photoelectric effect.
- List six different ways that electromotive force can be produced.
- Describe the proper method for connecting a voltmeter to a circuit and measuring voltage.
- Determine the output voltage from batteries connected in series aiding, series opposing, parallel, or series-parallel configurations.
- Given the magnitude and polarity of two charges, state whether a potential difference exists between them.
- Name the factors determining a cell's voltage and current capacity.
- Given a list of applications, match them with the effect produced by EMF.
- Name the three main parts of a cell.
- State the output voltage of a dry cell and a wet cell.
- State the relationship between a voltage rise and a voltage drop.

### Resistance

- Define the following terms: resistivity, resistance, conductance, ohm, thermistor, potentiometer, LDR, positive temperature coefficient, negative temperature coefficient, specific resistance, and rheostat.
- Name four factors that determine the resistance of a substance and state their relationship to the resistance.
- Differentiate a conductor from an insulator, in terms of resistance.
- Given the gauge, type, and length of wire, calculate the resistance.
- Determine a resistor's value and tolerance by examining its color code and its power rating by examining its size.
- Match components and test points on a schematic with its counterpart on a circuit board.
- Demonstrate the proper use of a voltmeter and ohmmeter.
- Isolate and replace open and shorted components in series, series-parallel, and RC circuits, and in a resistive bridge network.
- Demonstrate the proper method of testing resistors, capacitors, switches, and lamps.

### TEACHING/LEARNING PACKAGE OPTIONS

Instructor-Led/Pre-wired Boards/Textbook  
 Instructor-Led/Pre-wired Boards/CAI ExTra  
 Instructor-Led/Parts Packs/Textbook  
 Instructor-Led/Parts Packs/CAI LITE  
 Individualized Learning ILP & CAI LITE

### TRAINER

ETW-3600  
 ETW-3600  
 ETW-3600  
 ETW-3600  
 ETW-3600

### BACKPACK

ETW-3567  
 ETW-3567

### BOARDS/ MODULE

ETB-6101  
 ETB-6101

### PARTS PACK

EB-6101-31  
 EB-6101-31



## Course Objectives

- Calculate the total resistance of resistors in series, parallel, and series parallel configurations.
- State the effects of connecting resistors in series and parallel, in terms of circuit resistance.
- Describe the correct method for using an ohmmeter.
- State the relationship between resistance, current, and voltage.
- Name three types of fixed resistors.

## Ohm's Law

- Define the terms: power, watt, dissipation, and horsepower.
- State Ohm's law.
- Depending on the unknown quantity, use one of the three power equations to determine the power dissipated in a circuit.
- Select the equation and calculate the current, voltage, resistance, and power in any simple circuit in which two of the following quantities are known: voltage, resistance, power, and current.
- Describe how a voltmeter can be used to measure current.
- State the three equation forms of Ohm's law.

## Magnetism

- Define the terms: field, permanent magnet, temporary magnet, flux lines, ferromagnetic, paramagnetic, diamagnetic, permeance, permeability, artificial magnet, natural magnet, flux density, field intensity, reluctance, ampere turn, magnetic induction, residual magnetism, retentivity, alternator, and DC generator.
- List the four basic characteristics of flux lines.
- State the left-hand rule for conductors, coils, and generators, and the right-hand motor rule.
- Name the common factor that links electricity and magnetism.
- List the four factors that determine the amount of EMF induced in a conductor and state how they relate to the induced EMF.
- List the four basic parts of a simple DC generator.
- List ten electrical or electronic devices that use magnetism in one form or another and explain how they work.
- State Faraday's Law of magnetic induction.

## Electrical Measurements

- List six parts of the moving-coil meter movement and explain the purpose of each.
  - Demonstrate how the ammeter, voltmeter, and ohmmeter should be connected to a circuit under test.
  - Given the full scale deflection and the meter resistance, calculate the proper value of shunt required to increase the current capability to a given value.
- Use proper safety measures while troubleshooting live circuits.
  - Identify abnormalities in circuits caused by opens and shorts.
  - Use Ohm's Law to determine if readings are what they should be.
  - Demonstrate that resistive values measured across components may vary greatly from the same components out of a circuit.



## Course Objectives

- Given the full scale deflection and the meter resistance, calculate the series dropping resistance required to increase the voltage capability to a given value .
- Draw the schematic of a series ohmmeter and a shunt ohmmeter.
- Define and calculate meter sensitivity for a given meter movement.
- Explain how a single meter movement can be used in a VOM to indicate current, voltage, and resistance.
- Define voltmeter loading and explain how to minimize its effects.
- Name the components used to increase the range of a voltmeter and an ammeter.
- State at what point on a meter scale the most accurate readings are obtained, and the purpose of the "ZERO OHMS" variable resistor in an ohmmeter.
- Name the three most basic components of an ohmmeter.
- State how an ammeter can introduce an error when it is used to measure current.
- Define the term parallax.

## DC Circuits

- Define the terms: bleeder current, series dropping resistor, voltage divider, bridge network, linear circuit, and bilateral circuit.
- Given the current and voltage requirements for the separate loads, calculate the values of the resistors in a voltage divider.
- Given the values of the resistors in a bridge network, determine whether or not the bridge is balanced.
- Name three applications for a bridge circuit.
- Analyze a simple network by using the Superposition theorem, Thevenin's theorem, and Norton's theorem.
- Calculate unknown currents and voltages in a simple network by using Kirchhoff's law.
- Convert a Thevenin equivalent circuit to a Norton equivalent circuit.

## Inductance and Capacitance

- Define the terms: induction, inductance, counter EMF, capacitance, RC & RL time constants, farad, henry, self-induction, steady-state condition, transient-state condition, and dielectric.
- Identify the schematic symbol for an inductor and a capacitor.
- State the three physical factors that determine capacitance.
- Name two factors that increase the inductance of an inductor.
- State how to determine the direction of an EMF that is induced in a conductor.
- Given the values of resistance and inductance, determine the RL time constant for a circuit. Given the values of resistance and capacitance, determine the RC time constant for a circuit.
- Calculate total capacitance and inductance in series, parallel, and series-parallel circuits.

TEXT	WORKBOOK/ LAB MANUAL	INST GUIDE/ ADMIN GUIDE	IND.LEARNING PROGRAM	CAI	CAT <small>(optional)</small>	INST MGMT	VIDEO <small>(optional)</small>
EB-6101-A	EB-6101-71	EB-6101-52			CAT works with all packages. See p. 13 for order numbers.	CAI-6100-03	EV-3101-A
EB-6101-A	EB-6101-41 EB-6101-41	EB-6101-51 EB-6101-51		CAI-6101-02	Full utilization requires Instructor Management System.		EV-3101-A
			EE-3101-B	EEC-3101-03 EEC-3101-03			EV-3101-A EV-3101-A

# AC ELECTRONICS COURSES

AC Electronics introduces the principles and applications of alternating current. Students will develop an understanding of different types of AC circuits and learn the advantages of AC over DC. They'll learn to convert power requirements between horsepower, watts and current. They'll learn to analyze AC sine waves and perform critical calculations involving impedance, current, voltage and power ratios, plus build and

analyze low-pass, high-pass and band-pass filters. Several step-by-step experiments help reinforce theories and develop solid hands-on abilities.

In the CAI courses, students will see motor windings cut, flux lines, and control a simulated oscilloscope. They will plot cut-off frequencies, and adjust the turns ratio in a transformer.

*Course Objectives (Varies slightly depending on media selected)*

## COMPUTER-AIDED INSTRUCTION

CAI-6102-02 (CAI-ExTra)

EEC-3102-03 (CAI-LITE, 1 CEU)



## Alternating Current

- Define: alternating current (AC), sine wave, cycle, alternation, positive and negative alternation, instantaneous value, peak value, peak-to-peak value, effective value, average value, period, frequency, and hertz.
- State the difference between alternating current and direct current.
- Name three advantages of AC over DC.
- Name six general applications of alternating current.
- Describe the operation of the basic AC generator.
- State the four factors that affect voltage or current induced in a conductor.
- Determine the peak value, peak-to-peak value, effective value, average value, and period of a sine wave.
- Calculate the frequency of an AC signal.
- Name three types of AC waveforms (other than the sine wave).

## AC ELECTRONICS COURSE

EB-6102-A (Instructor-Led)

EE-3102-B (Individual Learning, 1.5 CEUs)



## AC Measurements

- Define: Lissajous pattern, CRT, graticule, and in-phase.
- Explain the operation of the basic rectifier-type, moving-coil meter.
- State how to increase the current or voltage range of a meter movement.
- Explain the operation of a thermocouple meter.
- Show the proper to use a clamp-on meter and its principles of operation.
- Explain the operating principles of a wattmeter and state how and why it is used.
- Explain the advantages of an oscilloscope compared to an AC voltmeter.
- Explain how the oscilloscope is used to measure a waveform's pulse width, period, amplitude, rate of change, and phase relationships.
- Analyze both series and parallel resistive AC circuits and determine their current and voltage values.
- State the phase relationship between current and voltage in a resistive circuit.

## AC ELECTRONICS VIDEO

EV-3102-A

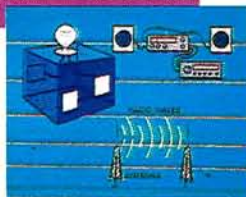

## Capacitive Circuits

- Identify capacitors and capacitor symbols.
- List the basic parts of a capacitor and explain its operation.
- Explain the factors that effect capacitance.
- List the most commonly used types of capacitors.
- Determine the total capacitance of capacitors connected in series and in parallel.
- Explain the most common ways in which capacitors fail.
- Define the term phase shift as it relates to capacitors.
- Draw a diagram illustrating the phase relationship between current and voltage in a purely capacitive circuit.
- Define capacitive reactance and compute its value in ohms when the capacitance and operating frequency are known.
- Explain the phase relationship between voltage and current in a series RC circuit, and a parallel RC circuit.

## COMPUTER-AIDED TROUBLESHOOTING

CAT-6102-02



- Match components and test points on a schematic with their counterparts on a circuit board.
- Demonstrate the proper use of a voltmeter, ohmmeter, signal generator, and oscilloscope.
- Isolate and replace open and shorted components in RC, RL, RLC, and transformer circuits.
- Demonstrate the proper method of testing capacitors, inductors, speakers

### TEACHING/LEARNING PACKAGE OPTIONS

Instructor-Led/Pre-wired Boards/Textbook  
 Instructor-Led/Pre-wired Boards/CAI ExTra  
 Instructor-Led/Parts Packs/Textbook  
 Instructor-Led/Parts Packs/CAI LITE  
 Individualized Learning ILP & CAI LITE

### TRAINER

ETW-3600  
 ETW-3600  
 ETW-3600  
 ETW-3600  
 ETW-3600

### BACKPACK

ETW-3567  
 ETW-3567

### BOARDS/MODULE

ETB-6102  
 ETB-6102

### PARTS PACK

EB-6102-31  
 EB-6102-31

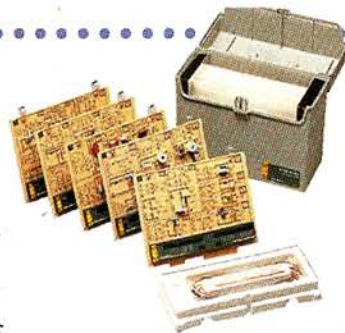

## Course Objectives

### Inductive Circuits

- Define: inductance, inductive reactance, self inductance, mutual inductance, coefficient of coupling, and RL filter.
- Draw a vector diagram illustrating the phase relationship between voltage and current in an RL circuit.
- Determine the impedance of an RL circuit.
- Calculate the phase angle for a series or a parallel RL circuit.
- Given the inductance and frequency, determine the inductive reactance of an inductor.
- Given the inductive reactance and frequency, determine the inductance of an inductor.
- Determine the Q of an inductor.
- Name three applications for RL circuits.
- Name four factors that affect the inductance of a coil.
- Explain the relationship of the L/R time.

### Tuned Circuits

- Define: resonance, resonant frequency, half-power point, fly-wheel effect, tank circuit, self-resonant, band-pass filter, and band-stop filter.
- Calculate the impedance, current, voltage, power factor, and phase angle for series and parallel RLC circuits.
- Determine the capacitor rating necessary to correct an inductive circuit for a unity power factor.
- State the characteristics of series resonant, and parallel resonant RLC circuits.
- Determine the Q of a series or parallel circuit at its resonant frequency.
- Calculate the power savings, in kilowatt hours, of a circuit that has been corrected to a unity power factor.
- From a given schematic, identify the six basic types of filters.
- Name the type of filter that produces a given response curve.
- Calculate the resonant frequency of an RLC circuit.
- Determine the bandwidth of a series or parallel resonant circuit.

### Transformers

- Define: transformer primary, transformer secondary, eddy current loss, hysteresis and five uses for the transformer.
- Calculate turns ratio, voltage ratio, power ratio, current ratio, impedance ratio and transformer efficiency.
- List four types of losses that effect transformer efficiency.
- Determine the relationship between voltage, current, and impedance ratios.
- Name the parts of an elementary transformer.

and transformers.

- Use proper safety measures while troubleshooting live circuits.
- Identify abnormalities in circuits caused by opens and shorts.
- Use Ohms Law to determine if readings are what they should be.
- Demonstrate that resistive values measured across components vary greatly from the same components out of a circuit.

## Course Objectives

- Differentiate a transformer from an autotransformer.
- Explain why the transformer is considered a safety device.

### Motors and Motor Controls

- Define the terms motor, inertia, and friction.
- Demonstrate the right-hand rule for motors.
- Explain the principle of electromagnetic induction.
- Explain the operation of the following types of motors: Series type, Shunt type, Compound type.
- Draw the waveform for a single-phase motor.
- Name the common use for a two-phase motor.
- Explain the phase relationships between the winding of a three-phase motor.
- Calculate the percent of regulation for a motor when the loaded and unloaded operating speed is known.
- Explain the relationship between magnetic field strength and RPM.
- State the type of motor that is called a universal motor.
- Explain the relationship between a motor's slippage and torque.
- Draw a DC control circuit that can reverse a motor's direction and change its speed of operation.
- Differentiate between a servo system and a synchro system using a schematic diagram.
- Define the terms synchronous and asynchronous.
- Explain torque in synchronous and asynchronous motors.

### AC Home Applications

- Explain the terms service drop and power distribution box.
- Identify the point at which the homeowners responsibility begins.
- Calculate the maximum AC load for a given power outlet.
- Explain the limitation placed on paralleling loads.
- Name the two common types of safety devices used to disconnect excessive loads from their voltage source.
- Identify which motors in your home are universal types and which are single phase, two phase, and three phase motors.
- Calculate the current, voltage, and power required to operate typical appliances from the data supplied on its nameplate.
- List the common electrical safety equipment that should be in every home.
- Identify the type of circuit used to recharge DC appliances such as cordless electric shavers, smoke detectors, portable mixers, and cordless hand held vacuum cleaners.
- Identify potential electrical fire hazards in the home.
- Explain the advantage and disadvantage of fuses compared to circuit breakers.

TEXT	WORKBOOK/ LAB MANUAL	INST GUIDE/ ADMIN GUIDE	IND. LEARNING PROGRAM	CAI	CAT (optional)	INST MGMT	VIDEO (optional)
EB-6102-A	EB-6102-71	EB-6102-52		CAI-6102-02	CAT works with all packages. See p. 13 for order numbers.	CAI-6100-03	EV-3102-A
EB-6102-A	EB-6102-41 EB-6102-41	EB-6102-51 EB-6102-51	EE-3102-B	EEC-3102-03 EEC-3102-03	Full utilization requires Instructor Management System.		EV-3102-A EV-3102-A EV-3102-A

# SEMICONDUCTORS COURSES

Students explore the world of semiconductors— diodes, bipolar transistors, FETS, thyristors and UJTs, Zeners and many more. Students learn how semiconductor devices are constructed, how to handle them, how various devices operate, and how to use them in practical circuits.

In the CAI courses, students will see holes and electrons

flow in full color. They will watch depletion regions created, and adjust the input voltage applied to a zener regulator. They will watch current flow through transistors and FETS. They will also see light sensitive devices in an entirely new and revealing way.

Course Objectives (Varies slightly depending on media selected)

## COMPUTER-AIDED INSTRUCTION

CAI-6103-02 (CAI-ExTra)

EEC-3103-03 (CAI-LITE, 1 CEU)



## SEMICONDUCTORS COURSE

EB-6103-A (Instructor-Led)

EE-3103-B (Individual Learning, 3 CEUs)



## SEMICONDUCTORS VIDEO

EV-3103-A

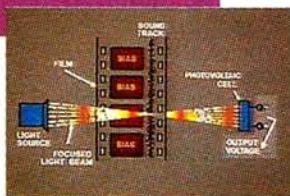

## COMPUTER-AIDED TROUBLESHOOTING

CAT-6103-01



## Semiconductor Fundamentals

- Identify three common semiconductor devices.
- Describe uses of semiconductor devices in electronic equipment.
- List five advantages semiconductor devices have over other components.
- Identify the two most commonly used semiconductor materials and identify their majority and minority current carriers.
- Describe the crystal lattice structure of semiconductors.
- Define the electrical characteristics of semiconductors.
- Describe the difference between intrinsic and doped semiconductors.
- Define the term "hole" as applied to semiconductors.
- Differentiate majority and minority carriers in a doped semiconductor.
- Explain trivalent and pentavalent materials and explain why they are used.

## Semiconductor Diodes

- Describe the construction of a semiconductor diode's PN junction.
- Recognize the schematic symbol of a semiconductor diode.
- Explain the difference between an atom and an ion.
- Describe the electrical characteristics of a PN junction.
- Identify the two diode parts on a schematic symbol and on an actual diode.
- Describe the effects of forward and reverse bias on a PN junction diode.
- Interpret a graph of diode voltage-current characteristics.
- Use an ohmmeter to determine if a diode PN junction is operational.
- List applications for semiconductor diodes.
- Identify different diode packages.

## The Zener Diode

- Explain forward and reverse current-voltage characteristics of a zener diode.
- Learn the relationship between temperature and zener diode power dissipation.
- Determine a zener diode's maximum safe operating current.
- Use a diode's zener impedance to determine the amount of change that can occur in the diode's zener voltage.
- Describe how the zener diode is used to provide voltage regulation.
- Identify a zener diode on a schematic diagram.
- Explain the terms "knee of the curve" and "reverse breakdown voltage."
- Compare a zener diode to a junction diode in terms of internal voltage drop.
- Draw the most common circuit that uses a zener diode as a regulator.
- Design a zener regulator circuit.

## Semiconductor Diodes for Special Applications

- Locate the peak current, valley current, peak voltage, and valley voltage points on a tunnel diode's V-I curve.
- Explain the term negative resistance.

- Match components and test points on a schematic with their counterparts on a circuit board.
- Demonstrate the proper use of a voltmeter, ohmmeter, signal generator, and oscilloscope.
- Isolate and replace open and shorted components in voltage divider, common-gate amplifier, relay control, and photoresistive alarm circuits.
- Demonstrate the proper method of testing diodes, capacitors, transis-

### TEACHING/LEARNING PACKAGE OPTIONS

Instructor-Led/Pre-wired Boards/Textbook  
 Instructor-Led/Pre-wired Boards/CAI ExTra  
 Instructor-Led/Parts Packs/Textbook  
 Instructor-Led/Parts Packs/CAI LITE  
 Individualized Learning ILP & CAI LITE

### TRAINER

ETW-3600  
 ETW-3600  
 ETW-3600  
 ETW-3600  
 ETW-3600

### BACKPACK

ETW-3567  
 ETW-3567

### BOARDS/MODULE

ETB-6103  
 ETB-6103

### PARTS PACK

EB-6103-31  
 EB-6103-31



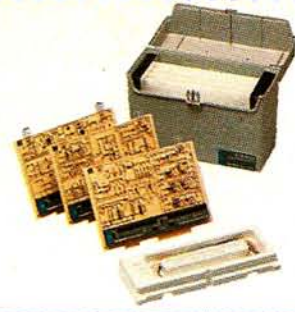
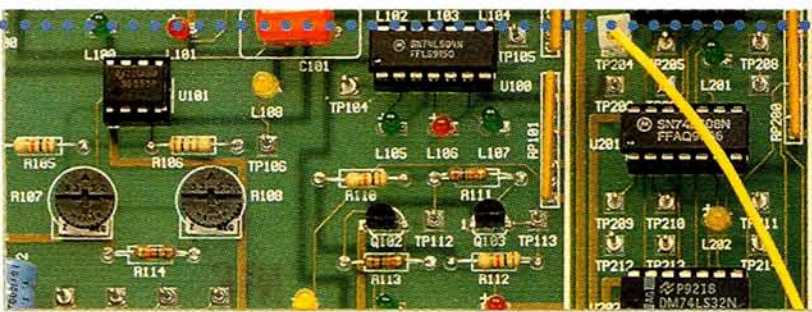

## Course Objectives

- Identify the negative resistance region of a tunnel diode's characteristic curve.
- Identify common tunnel diode & varactor diode schematic symbols.
- Explain how capacitance is varied within a varactor diode.
- Understand how a varactor's internal capacitance and Q are affected by a change in operating voltage.
- Name four special diode types other than tunnel and varactor diodes, and state an application for each.
- From a schematic diagram identify: *PN junction diode, Zener diode, Tunnel diode, Varactor diode, and Schottky diode*

## Bipolar Transistor Operation

- Describe the construction of the two types of bipolar transistors.
- Understand the principle behind bipolar transistor operation.
- Show how a bipolar transistor is biased for normal operation.
- Explain the relationship between emitter current, base current, and collector current in a bipolar transistor.
- Identify the three basic transistor amplifier circuit configurations.
- Test bipolar transistors with an ohmmeter.
- Determine if a transistor is a PNP or NPN type, and which lead is the base lead using only an ohmmeter.
- From schematic diagrams identify: NPN transistors, PNP transistors, base, emitter, and collector leads.

## Bipolar Transistor Characteristics

- Determine the current gain (alpha) of common-base and common-emitter transistors using a transistor's collector characteristic curve.
- Explain the meaning of the term "alpha cut-off frequency."
- Explain  $I_{CBO}$  and  $I_{CEO}$ , and why they are important.
- Explain the terms: beta *cut-off frequency*, and *buffer amplifier*.
- Determine alpha when beta is known and vice-versa.
- Determine the approximate input and output resistance of a common-collector transistor circuit.
- Explain why a common emitter arrangement inverts.
- List the circuit arrangement/configuration preferred for the following applications, and explain why it is the preferred choice: power amplification, voltage amplification, current amplification, polarity inversion, impedance matching, isolation, high frequency operation.

## Field Effect Transistors

- Describe how a junction FET operates.
- Use a FET's drain characteristic curves to determine the transconductance of the device.
- Properly bias both N-channel and P-channel JFET's.
- Explain the meaning of the expressions  $V_{GS}$  (off and VP).

- tors, thyristors, and photoresistive cells.
- Use proper safety measures while troubleshooting live circuits.
- Identify abnormalities in circuits caused by opens and shorts.
- Use Ohms Law to determine if readings are what they should be.
- Demonstrate that resistive values measured across components may vary greatly from the same components out of a circuit.

## Course Objectives

- Explain the basic difference between the JFET and MOSFET.
- Describe the difference between depletion-mode and enhancement-mode IGFETs.
- Properly bias depletion-mode and enhancement-mode IGFETs.
- Name the three basic FET circuit arrangements.
- Explain the advantages and disadvantages of FETs when compared to bipolar transistors.
- Build a circuit using an FET as the amplifying component.
- From a schematic point out the: *N-channel FET, P-channel FET, depletion-mode IGFET, enhancement mode IGFET.*

## Thyristors

- Describe the conditions needed to turn on and off a: silicon controlled rectifier, bi-directional triode thyristor, unijunction transistor.
- Explain the difference between a silicon controlled rectifier's forward breakover and reverse breakdown voltage.
- Name two applications of the silicon controlled rectifier, and for the bi-directional triode thyristor.
- Describe the operation of the bi-directional trigger diode.
- Name the most important use of a bi-directional trigger diode.
- Explain how a unijunction transistor exhibits a negative resistance once it is turned on.
- Name two applications of the unijunction transistor.
- Describe the difference between an ordinary unijunction transistor and a programmed unijunction transistor.
- From a schematic, identify: SCR, TRIAC, DIAC, UJT, PUT.

## Integrated Circuits

- State the need for integrated circuits in electronics.
- Name at least three advantages and disadvantages that integrated circuits have in comparison to conventional circuits.
- Explain the difference between monolithic, film-type, and hybrid integrated circuits.
- Differentiate between linear and digital integrated circuits.
- Identify basic integrated circuit packages.
- Explain the difference between SSI, MSI, and LSI circuits.

## Optoelectric Devices

- Describe the major characteristics of light.
- Determine the wave length of any given light frequency.
- Differentiate radiometric and photometric systems for measuring light.
- Describe the function of light sensitive and light emitting devices.
- Name four photosensitive devices and describe their operation.
- Describe the principle of operation of the light-emitting diode.
- Name three advantages that the light emitting diode has over an incandescent or neon lamp.
- Explain the principles of operation of a liquid-crystal display.
- Identify at least one advantage of liquid-crystal over other types of displays and at least one disadvantage of liquid crystal displays.
- Name the photosensitive device that is the fastest operating.
- Distinguish between the LED and photodiode schematic symbols.

TEXT	WORKBOOK/ LAB MANUAL	INST GUIDE/ ADMIN GUIDE	IND. LEARNING PROGRAM	CAI	CAT (optional)	INST MGMT	VIDEO (optional)
EB-6103-A	EB-6103-71	EB-6103-52					EV-3103-A
EB-6103-A	EB-6103-41 EB-6103-41	EB-6103-51 EB-6103-51		CAI-6103-02	CAT works with all packages. See p. 13 for order numbers. Full utilization requires Instructor Management System.	CAI-6100-03	EV-3103-A EV-3103-A EV-3103-A EV-3103-A
			EE-3103-B	EEC-3103-03 EEC-3103-03			

For Pricing, See Center of Catalog

# ELECTRONIC CIRCUITS COURSES

This course allows students to scrutinize the fascinating world of electronic circuits and take a detailed look at circuit applications to every-day appliances.

Students will see electronics in their home in a whole new light after taking this course. Students will analyze and design inverting and noninverting amplifiers, build transistor and integrated circuit amplifiers, oscillators, active filters and

a working AM transmitter. Students will gain a deeper understanding of voltage regulation, oscillation, amplitude and frequency modulation. Computer-Aided Instruction allows students to explore cutoff and saturation, and see all the waveforms in a complementary amp simultaneously, and adjust differential amps. Students will adjust mixing amps, and see filters and rectifiers in action.

Course Objectives (Varies slightly depending on media selected)

## COMPUTER-AIDED INSTRUCTION

CAI-6104-02 (CAI-ExTra)

EEC-3104-03 (CAI-LITE, 1 CEU)

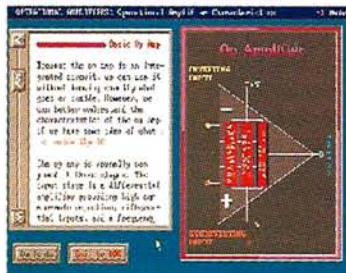

## Basic Amplifiers

- Name the two basic functions of amplifiers.
- Identify the three basic amplifier circuit configurations.
- Describe the most important characteristics of each type of amplifier circuit.
- Identify the most basic biasing arrangements that are used with common emitter transistor circuits.
- Explain how each basic biasing circuit operates.
- Design a basic common-emitter amplifier circuit to operate class A.
- Explain the purpose of placing a resistor in the transistor's emitter circuit.
- Determine if a transistor amplifier is operating in class A, AB, B, or C mode.
- Explain why amplifiers operated class A are preferred for audio equipment.
- Identify the four basic amplifier coupling techniques and state the advantages and disadvantages of each.

## ELECTRONIC CIRCUITS COURSE

EB-6104-A (Instructor-Led)

EE-3104-B (Individual Learning, 4 CEUs)



## Typical Amplifiers

- Explain the function and operation of DC, audio, video, RF, and IF amplifiers.
- Identify the Darlington arrangement and tell how it operates.
- Describe how a differential amplifier can be used to amplify a single input signal and why the circuit offers a high degree of temperature stability.
- Identify three different types of power amplifiers.
- Explain how volume and tone can be controlled in an audio amplifier.
- Describe how the video amplifier obtains its wide bandwidth.
- List three ways of increasing the bandwidth in RF and IF amplifiers.
- Explain the basic difference between IF and RF amplifiers.
- Explain the purpose of amplifier neutralization.
- Explain how a frequency multiplier works.

## Operational Amplifiers

- Explain how a differential amplifier works and list the advantages, disadvantages, and characteristics of a differential amplifier.
- Determine the amount of current provided by a constant current source.
- Define common mode rejection ratio, input resistance, output resistance, offset voltage, offset current, bias current, slew rate, and other terms found on data sheets for operational amplifiers.
- Define and explain the operation of the comparator circuit.
- Analyze and design simple inverting and noninverting amplifiers using operational amplifiers.
- Describe the characteristics and purpose of the voltage follower.
- Recognize the schematic diagram and explain the operation of the summing amplifier and the difference amplifier.
- Describe the operation and characteristics of the low-pass, high-pass, and band-pass active filters.
- Troubleshoot complex circuits using a schematic as a guide.

## ELECTRONIC CIRCUITS

VIDEO EV-3104-A



## COMPUTER-AIDED TROUBLESHOOTING

CAT-6104-01



- Match components and test points on a schematic with its counterpart on a circuit board.
- Demonstrate the proper use of a voltmeter, ohmmeter, and oscilloscope.
- Identify various electronic circuits and their characteristics.
- Isolate and replace open and shorted components in various circuits.
- Demonstrate the proper method of testing capacitors, transistors, diodes, resistors and bridge rectifiers.

## TEACHING/LEARNING PACKAGE OPTIONS

Instructor-Led/Pre-wired Boards/Textbook  
 Instructor-Led/Pre-wired Boards/CAI ExTra  
 Instructor-Led/Parts Packs/Textbook  
 Instructor-Led/Parts Packs/CAI LITE  
 Individualized Learning ILP & CAI LITE

## TRAINER

ETW-3600  
 ETW-3600  
 ETW-3600  
 ETW-3600  
 ETW-3600

## BACKPACK

ETW-3567  
 ETW-3567

## BOARDS/MODULE

ETB-6104-A  
 ETB-6104-A

## PARTS PACK

EB-6104-31  
 EB-6104-31

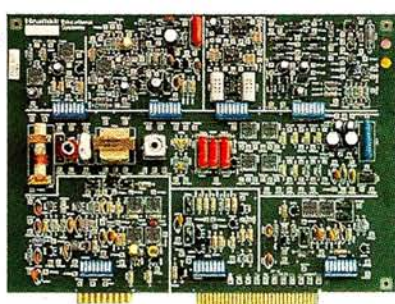

## Course Objectives

### Power Supplies

- Define the term rectification.
- List the characteristics and explain the operation of half wave, full-wave, and bridge rectifiers.
- Explain when transformer coupling is preferable to direct coupling.
- Explain the effect of a filter capacitor on output voltage, ripple voltage, and the diode peak inverse voltage.
- Describe the characteristics of capacitor, resistor-capacitor, and inductor-capacitor filters.
- Describe the operation of half-wave and full-wave voltage multipliers.
- Design a simple zener regulator, an emitter-follower regulator, and a simple series-feedback regulator using an Op amp.
- Explain the operation of series and shunt regulators.
- Explain the operation of protective circuits and devices including: current limiting circuits, crowbar circuits, fuses, and circuit breakers.

### Oscillators

- List the three general classes of feedback oscillators.
- Calculate the frequency of common LC oscillators.
- Explain the operation and application for relaxation oscillators.
- Differentiate between the series-fed, shunt-fed, Hartley, Colpitts, relaxation type, and Pierce oscillators using schematic diagrams.
- Calculate the feedback factor for a Colpitts oscillator when given the capacitor values.
- Determine expected frequency changes that result when reactive values are varied in LC oscillators.
- Look at the schematic of a crystal oscillator and determine whether the crystal is operating in its series-resonant or parallel resonant mode.
- Explain the crystal frequency selective characteristics.
- Recognize crystal oscillators, phase-shift, and Wien-bridge oscillators.
- Explain how frequency variations affect the output of a phase shift network in the Wien-bridge oscillator.
- Calculate the frequency of a phase-shift oscillator when given the values of resistance and capacitance.
- Determine frequency changes that result from variations of RC components in RC oscillators.
- Identify the frequency determining components in a blocking oscillator.
- Explain the changes in nonsinusoidal oscillator's when their discrete components are varied.
- Explain the advantage of crystal oscillators.
- Explain the operation of an op-amp Wien-bridge oscillator and its automatic gain control circuit.

- Use proper safety measures while troubleshooting live circuits.
- Identify abnormalities in various circuits caused by opens and shorts.
- Use Ohm's Law to determine if readings are what they should be.

## Course Objectives

### Pulse and Control Circuits

- Explain the difference between time domain and frequency domain analysis.
- Explain the difference between periodic and aperiodic waveforms.
- Identify the sine wave components contained in square waves, sawtooth waves, and triangle waveforms.
- Compute the frequency, period, pulse width, and duty cycle of pulse type waveforms.
- Given the input waveform, draw the output waveform of biased and unbiased, series and shunt diode clippers.
- Given the input waveform, draw the output waveform of slicers, clampers, and transistor clippers.
- Explain how square waves and sine waves are affected by RC integrators and differentiators.
- Describe the operation of astable, monostable, and bistable multivibrators.
- Explain the operation of a simple Schmitt trigger circuit
- Show how a "555 timer" can be connected as an astable or monostable multivibrator.
- Show an operational amplifier made to produce a linear ramp.
- Explain the operation of a transistor sawtooth Generator.
- Identify a variety of components and their circuit configurations from a schematic diagram.
- Troubleshoot electronic circuits using schematic diagrams and test equipment.

### Modulation

- Explain the advantages, disadvantages, and characteristics of amplitude modulation, single sideband, and frequency modulation.
- Explain the operation of a basic amplitude modulator, balanced modulator, frequency modulator, and AM and FM detectors.
- Draw block diagrams of basic AM, SSB, and FM transmitters and receivers.
- Identify circuit configurations as to what type modulation is being used from a schematic diagram.
- Explain the operation of a mixer stage.
- Draw examples of AM modulating envelopes illustrating over modulation and 100% modulation.
- State the percent of total power contained in a single sideband.
- Explain the term frequency deviation as it pertains to FM.
- State the frequency range and the IF frequencies used in standard AM and FM commercial broadcast bands.

TEXT	WORKBOOK/ LAB MANUAL	INST GUIDE/ ADMIN GUIDE	IND.LEARNING PROGRAM	CAI	CAT (optional)	INST MGMT	VIDEO (optional)
EB-6104-A	EB-6104-71	EB-6104-52		CAI-6104-02	CAT works with all packages. See p. 13 for order numbers.	CAI-6100-03	EV-3104-A
EB-6104-A	EB-6104-41 EB-6104-41	EB-6104-51 EB-6104-51	EE-3104-B	EEC-3104-03 EEC-3104-03	Full utilization requires Instructor Management System.		EV-3104-A EV-3104-A EV-3104-A

# ELECTRONIC FUNDAMENTALS COURSE



## Electronic Fundamentals Course EB-200

You can teach electronic fundamentals better, faster and more thoroughly than ever before... with the EB-200 Electronic Fundamentals series:

### Fast-Track Fundamentals

The EB-200 covers a lot of ground in just a short time. Where some courses end, the EB-200 goes on, teaching all four essential areas of electronic fundamentals: DC Electronics, AC Electronics, Semiconductors and Electronic Circuits.

You can condense the EB-200 into one semester or spread it over two, and you'll always be sure that students are getting just the right amount of information.

### A True Introductory Course

The best electronic fundamentals course should be loaded with relevant information and present it in a way that ensures understanding.

Like all Heathkit courses, the EB-200 course is arranged in a readable, logical fashion, easing transition from one subject to the next. Chapters begin with an introduction and a set of objectives, then end with a self-test and a chapter summary. In between, concepts are presented in Heath's proven crystal-clear style, as this well-illustrated text takes the student from the simple to the complex, from the concrete to the abstract.

### A Complete Package

The EB-200 textbook is the nucleus of a complete electronic fundamentals program. You won't find another electronic fundamentals program that combines this depth of knowledge with such a wide scope of support materials... and it's all available from a single source.

And how's this for convenience? To perform the 40 workbook experiments, you can use either our ETW-3600 Analog Trainer or similar trainers you already have in place.

#### TEACHING/LEARNING PACKAGE OPTIONS

Instructor-Led/Pre-wired Boards/Textbook  
 Instructor-Led/Pre-wired Boards/CAI ExTra  
 Instructor-Led/Pre-wired Boards/CAI LITE  
 Instructor-Led/Parts Packs/Textbook  
 Instructor-Led/Parts Packs/CAI ExTra  
 Instructor-Led/Parts Packs/CAI LITE

#### TRAINER

ETW-3600  
 ETW-3600  
 ETW-3600  
 ETW-3600  
 ETW-3600  
 ETW-3600

#### BACKPACK

ETW-3567  
 ETW-3567  
 ETW-3567

#### BOARDS/MODULE

ETB-200  
 ETB-200  
 ETB-200

#### PARTS PACK

EB-200-30  
 EB-200-30  
 EB-200-30

## From Experts In The Field

Heathkit Educational Systems grew out of Heath Company (famous for fool-proof documentation), making us the only developer of technical training materials associated with a world-wide manufacturer of consumer electronics.

So you know that the EB-200 Electronic Fundamentals course is developed and supported by experts in education and electronics... and not by just another publisher or distributor.

## The EB-200 Training Package

**The Textbook** covers most of the same learning objectives as the courses on pages 20-27. It is 960 pages of fast-paced, focused instruction, divided into 30 chapters under four sections:

DC Electronics: introduces students to the terms and concepts of electronics. **Outline:** *Physics of Electronics; Current and Voltage; Properties of Electrical Circuits; Resistance; Electrical Measurements; Ohm's Law; Power; DC Circuits; Magnetism; Reactive Components.*

AC Electronics: explores alternating current and the many applications that take advantage of it like motors, generators, filters, and transformers. **Outline:** *Introduction to AC; Measuring AC; AC Resistance; AC Capacitance; AC Inductance; RLC Circuits; Transformers.*

Semiconductors: discusses the operation of diodes, transistors, integrated circuits and solar cells, and illustrates the role they play in today's high-tech equipment. **Outline:** *Physics of Semiconductors; Junction Diodes; Zener Diodes; Bipolar Transistors; Field Effect Transistors; Control Devices; Light-Sensitive Devices.*

Electronic Circuits: leads students through the circuits found in almost all electronics equipment, from amplifiers and power supplies to oscillators, multivibrators and waveshaping circuits. **Outline:** *Basic Amplifiers; Amplifier Applications; Operational Amplifiers; Power Supplies; Oscillators; Waveshaping Circuits.*

**The Instructor's Guide** has answers to all questions in the textbook and workbook, two separate final exams, and suggested lesson

plans for both one- and two-semester courses.

**The Student Workbook** contains 40 hands-on experiments that let students read about a circuit in the text, then build, test and analyze that circuit for themselves. This hands-on learning approach greatly improves retention of the fundamentals.

**The Experiment Parts Pack** includes resistors, capacitors, inductors, transistors, diodes, LEDs... everything students will need to perform the workbook experiments.

For even greater convenience and efficiency in your lab, we also offer the ETB-3300 Breadboard Experiment Module. This module allows students to wire several different experiments on one large breadboard.

**Pre-wired Experiment Boards** represent yet another step up in convenience and time-reduction. These boards are incredibly easy to use and dramatically reduce the overall amount of time needed to teach the course.

## Computer-Aided Instruction (CAI)

Now, the EB-200 course can be taught through this new medium so accepted and appreciated by students. Following the same lesson plan as the textbook, yet further condensed to speed-up learning, Heathkit CAI brings a new level of effectiveness to electronics teaching. We did not simply put the words and a few rough drawings on a computer screen, as did others. We took the time and put forth the investment to develop a teaching system that would fully utilize the power of computers. Please see a full description of this exciting software-based teaching system on pages 10-14.

You can use our CAI ExTra DC, AC, Semiconductors, and Electronics Circuits programs to cover the theory portion of the class. Then use the EB-200-71 workbooks with our ETB-200 Pre-wired Experiment Boards to complete the laboratory exercises. This package harnesses the power of the computer to give the instructor an automated means of tracking and grading students in the classroom, and the easiest-to-use and fastest laboratory set-up around. Yet it is a bargain even when compared to inferior packages offered by other companies.

TEXT	WORKBOOK/ LAB MANUAL	INST GUIDE/ ADMIN GUIDE	CAI	CAT (optional)	INST MGMT	VIDEO (optional)
EB-200	EB-200-71 EB-200-71 EB-200-71	EB-200-52 EB-200-52 EB-200-52	CAI-610(1,2,3,4)-02 EEC-310(1,2,3,4)-03	CAT works with all packages. See p. 13 for order numbers. Full utilization requires Instructor Management System.	CAI-6100-03	EV-310(1,2,3,4)-A EV-310(1,2,3,4)-A EV-310(1,2,3,4)-A
EB-200	EB-200-40 EB-200-40 EB-200-40	EB-200-50 EB-200-50 EB-200-50	CAI-610(1,2,3,4)-02 EEC-310(1,2,3,4)-03		CAI-6100-03	EV-310(1,2,3,4)-A EV-310(1,2,3,4)-A EV-310(1,2,3,4)-A

# CONCEPTS OF ELECTRICITY

This course is a perfect introduction to the fundamental properties and applications of electricity. Laying down a solid foundation of knowledge, this course opens the doors to a wide array of career opportunities for a great many students.

The course begins by introducing the properties of electricity and fundamentals of direct current. Next comes a study of electrical circuit theory and its application to everyday -

electromechanical devices such as the solenoid, relay and DC motor. From there, the course covers AC, generators, basics of meters, and how to solve basic problems in electricity.

Students use a parts package to build electrical circuits, measuring their characteristics and observing their operation—getting the real-world applications-based training needed for a thorough understanding.

## Course Objectives

### CONCEPTS OF ELECTRICITY

EB-3100 (Instructor-Led)

EE-3100 (Individual Learning, 1 CEU)

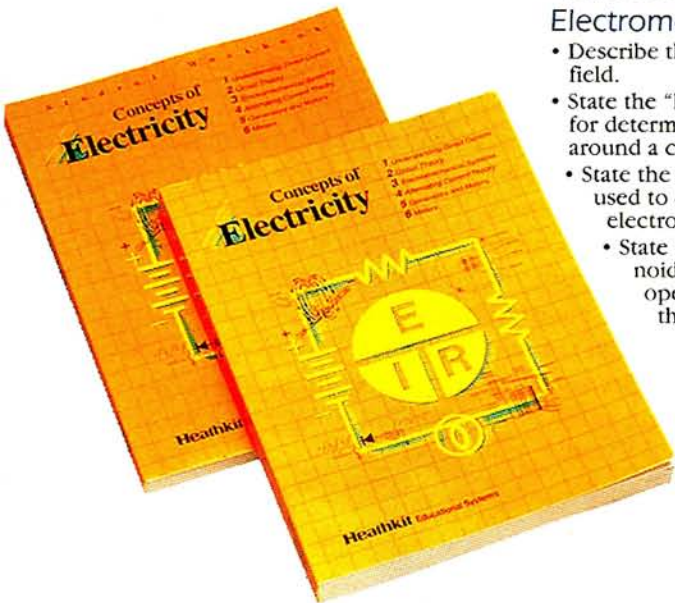
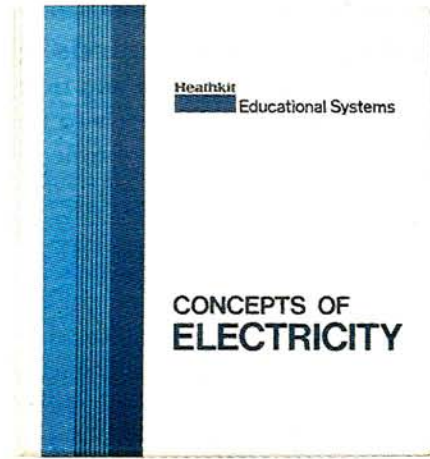

### Direct Current

- Define current and identify ampere as the unit of measure.
- Define voltage and identify volt as the unit of measure.
- Define resistance and identify ohm as the unit of measure.
- Use Ohm's Law to determine an unknown electrical circuit value when the other two values are known.
- Define power and identify watt as the unit of measure.
- Calculate the power of an electrical circuit.

### Circuit Theory

- Identify series, parallel, and series-parallel circuits and the characteristics of each.
- Determine series circuit resistance, current, or voltage when you know two of the three values.
- Determine total parallel circuit resistance when you know the individual branch resistances.
- Determine parallel circuit resistance, current, or voltage when you know two of the three values.
- Determine series-parallel circuit resistance, current, or voltage when you know two of the three values.
- Calculate the power consumed by a component or by an entire series, parallel, or series-parallel circuit.

### Electromechanical Systems

- Describe the characteristics of a magnetic field.
- State the "left-hand magnetic-field rule" for determining the direction of flux around a current-carrying conductor.
- State the "left-hand rule for coils" that's used to determine the north pole of an electromagnet or a solenoid.
  - State the purpose of a relay, solenoid, and DC motor, describe the operation of each, and identify the parts of each.

### Alternating Current Theory

- Describe Alternating Current and explain its waveform.
- Define voltage as it relates to AC.
- Explain the difference between peak voltage and peak-to-peak voltage.
- Determine the average value and effective (rms) value of a sine wave.
- Use Ohm's Law to calculate unknown electrical values using known values.
- Calculate the power in an AC circuit.

### Generators and Motors

- Describe the three ingredients needed for electromagnetic induction.
- Explain why an AC generator is often more practical than a DC generator.
- Describe how a capacitor "filters" the output of a DC generator.
- State the reason diodes are needed for AC-to-DC conversion.
- Describe the operation of a diode rectifier.
- Explain why an AC motor is used more often than a DC motor.
- Differentiate between permanent magnet induction and transformer action.

### Meters

- Describe the construction of a moving-coil meter movement.
- Recognize ammeter, voltmeter, and ohmmeter circuits from the schematic diagram.
- State the purpose of a shunt resistor in an ammeter.
- State the purpose of a multiplier resistor in a voltmeter.
- State the purpose of a battery in an ohmmeter.
- Calculate the full scale voltage for a simple voltmeter, knowing the meter's current and resistance characteristics.
- Describe how the loading effect of a voltmeter can be reduced.
- State the reason for rectifier diodes in an AC voltmeter.
- Identify and read values from the various scales on a multimeter.
- Use the accuracy specification of a meter to determine the actual value of a measurement.
- Use the resolution specification of a meter to determine the actual value of a measurement.
- Determine the loading effect of a meter, knowing its input sensitivity.

#### SUBJECT

CONCEPTS OF ELECTRICITY

(Instructor-Led/with Parts Packs)  
(Individualized Learning)

#### TRAINER

ETW-3600  
ETW-3600

#### PARTS PACK

EB-3100-30

#### TEXT

EB-3100

#### WORKBOOK/ LAB MANUAL

EB-3100-40

#### INST GUIDE/ ADMIN GUIDE

EB-3100-50

#### IND.LEARNING PROGRAM

EE-3100

Model	Description	Wt	Price
-------	-------------	----	-------

## Page 6 and 7

### Pre-wired Experiment Boards

ETB-200	Electronic Fundamentals Boards	(4 lbs)	\$399.95
ETB-3300	Breadboard Experiment Board	(2 lbs)	\$149.95
ETB-6101	DC Electronics Experiment Boards	(5 lbs)	\$399.95
ETB-6102	AC Electronics Experiment Boards	(5 lbs)	\$399.95
ETB-6103	Semiconductors Experiment Boards	(4 lbs)	\$299.95
ETB-6104-A	Electronic Circuits Experiment Board	(2 lbs)	\$249.95
ETB-6201-A	Digital Techniques Experiment Board	(2 lbs)	\$249.95
ETB-6820	Microprocessor Experiment Boards	(4 lbs)	\$499.95
ETB-8085	Microprocessor Experiment Boards	(4 lbs)	\$499.95
ETW-3567	Accessory Backpack	(6 lbs)	\$249.95

## Page 10 and 11

### Computer-Aided Instruction (CAI)

CAI-6101-02	DC Electronics CAI-ExTra	(1 lb)	see below
CAI-6102-02	AC Electronics CAI-ExTra	(1 lb)	see below
CAI-6103-02	Semiconductor Devices CAI-ExTra	(1 lb)	see below
CAI-6104-02	Electronic Circuits CAI-ExTra	(1 lb)	see below
CAI-6201-01	Digital Techniques CAI-ExTra	(1 lb)	see below
CAI-6810-01	Microprocessors CAI-ExTra	(1 lb)	see below
CAI-6100	Instructor Management Sys 5.25" Disks	(1 lb)	\$699.95
CAI-6100-03	Instructor Management Sys 3.5" Disks	(1 lb)	\$699.95
EEC-3101-03/5	DC Electronics CAI-LITE	(2 lbs)	\$149.95
EEC-3102-03/5	AC Electronics CAI-LITE	(2 lbs)	\$149.95
EEC-3103-03/5	Semiconductor Devices CAI-LITE	(2 lbs)	\$149.95
EEC-3104-03/5	Electronic Circuits CAI-LITE	(2 lbs)	\$149.95
EEC-3201-03/5	Digital Techniques CAI-LITE	(2 lbs)	\$149.95
EEC-3401-03/5	Microprocessors CAI-LITE	(2 lbs)	\$149.95

#### CAI-ExTra

FIRST INSTALLATION	\$400.00
2-5 PRICE PER INSTALLATION	\$200.00
6+ PRICE PER INSTALLATION	\$100.00

(Pricing assumes that all software is installed at one location. For other situations, please consult with your Heathkit Distributor.)

**CAI-ExTra Special Introductory Offer** - One installation each of DC & AC Electronics, Semiconductor Devices, Electronic Circuits, Digital Techniques and Microprocessors all for only **\$995!** Order Number **CAI-6000**. (6 lbs.) (Limit, one per site. Available only through your authorized Heathkit Distributor. See page 58 for a complete listing of Distributors.)

## Page 12 and 13

### Computer-Aided Troubleshooting (CAT)

CAT-6101-01	DC Electronics Troubleshooting	(1 lb)	see below
CAT-6102-01	AC Electronics Troubleshooting	(1 lb)	see below
CAT-6103-01	Semiconductors Troubleshooting	(1 lb)	see below
CAT-6104-01	Electronic Circuits Troubleshooting	(1 lb)	see below
CAI-6100	Instructor Management Sys 5.25" Disks	(1 lb)	\$699.95
CAI-6100-03	Instructor Management Sys 3.5" Disks	(1 lb)	\$699.95

#### Computer-Aided Troubleshooting

FIRST INSTALLATION	\$300.00
2-5 PRICE PER INSTALLATION	\$150.00
6+ PRICE PER INSTALLATION	\$100.00

(Pricing assumes that all software is installed at one location. For other situations, please consult with your Heathkit Distributor.)

## Page 14

### Instructor Management System (IMS)

CAI-6100	Instructor Mgmt System 5.25" Disks	(1 lb)	\$699.95
CAI-6100-03	Instructor Mgmt System 3.5" Disks	(1 lb)	\$699.95
EV-3113	Linear Power Supplies Video	(1 lb)	\$59.95
EV-3114	Switching Power Supplies Video	(1 lb)	\$59.95

Model	Description	Wt	Price
-------	-------------	----	-------

## Page 15

### Electronics Videos

EV-3110	Oscilloscope Video	(1 lb)	\$59.95
EV-3111	Test Instrument Video	(1 lb)	\$59.95
EV-3112	Op Amps Video	(1 lb)	\$59.95
EV-3133-A	Soldering Video	(1 lb)	\$59.95
EV-3135-A	Component Recognition Video	(1 lb)	\$59.95
EV-3136	Surface Mount Soldering Video	(1 lb)	\$59.95

## Page 16

### ETW-3600 Analog Trainer

ETW-3600	Analog Trainer	(6 lbs)	\$249.95
ET-3600	Analog Trainer (kit)	(6 lbs)	\$149.95
ETA-3600-01	Extra Breadboard Block	(1 lb)	\$29.95

## Page 17

### ETW-3700 Digital Trainer

ETW-3700	Digital Trainer	(6 lbs)	\$249.95
ET-3700	Digital Trainer (kit)	(6 lbs)	\$149.95
ETA-3600-01	Extra Breadboard Block	(1 lb)	\$29.95

## Page 18

### ETW-3800 Microprocessor Trainer

ETW-3800	Microprocessor Trainer	(6 lbs)	\$599.95
ETC-128	Memory Module for ETW-3800	(2 lbs)	\$99.95
ETC-6811	Motorola 6811 CPU Module	(2 lbs)	\$199.95
ETC-8085	Intel 8085 CPU Module	(2 lbs)	\$199.95
ETA-3600-01	Extra Breadboard Block	(1 lb)	\$29.95

## Page 19

### ETW-3400-A & ETW-1000 Trainers

ETW-3400-A	Microprocessor Trainer	(6 lbs)	\$499.95
ET-3400-A	Microprocessor Trainer (kit)	(6 lbs)	\$349.95
ETW-1000	Analog/Digital Trainer	(14 lbs)	\$399.95
ET-1000	Analog/Digital Trainer (kit)	(14 lbs)	\$299.95
ET-1000-01	Extra Breadboard	(1 lb)	\$29.95

## Page 20 and 21

### DC Electronics

CAI-6100	Instructor Management Sys 5.25" Disks	(1 lb)	\$699.95
CAI-6100-03	Instructor Management Sys 3.5" Disks	(1 lb)	\$699.95
CAI-6101-02	DC Electronics CAI-ExTra	(1 lb)	see below
CAT-6101-01	DC Computer-Aided Troubleshooting	(1 lb)	see below
EB-6101-A	DC Electronics Text	(2 lbs)	\$24.95
EB-6101-31	DC Electronics Parts Pack	(1 lb)	\$29.95
EB-6101-41	DC Electronics Workbook	(2 lbs)	\$15.95
EB-6101-51	DC Electronics Instructor's Guide	(1 lb)	\$12.95
EB-6101-52	DC Experiment Boards Admin Guide	(1 lb)	\$12.95
EB-6101-71	DC Experiment Boards Workbook	(2 lbs)	\$15.95
EE-3101-B	DC Individual Learning Program (ILP)	(7 lbs)	\$99.95
EEC-3101-03	DC Electronics CAI-LITE 3.5" Disks	(2 lbs)	\$149.95
EEC-3101-05	DC Electronics CAI-LITE 5.25" Disks	(2 lbs)	\$149.95
ETB-6101	DC Pre-wired Experiment Boards	(5 lbs)	\$399.95
ETW-3567	Accessory Backpack	(6 lbs)	\$249.95
ETW-3600	Analog Trainer	(6 lbs)	\$249.95
ET-3600	Analog Trainer (kit)	(6 lbs)	\$149.95

Model	Description	Wt	Price
EV-3101-A	DC Electronics Video	(1 lb)	\$59.95
	<b>CAI-ExTra Compr-Aided Troubleshooting</b>		
	FIRST INSTALLATION	\$400	\$300
	2-5 PRICE PER INSTALLATION	\$200	\$150
	6+ PRICE PER INSTALLATION	\$100	\$100

*(Pricing assumes that all software is installed at one location. For other situations, please consult with your Heathkit Distributor. Also, see Introductory Special listed with pricing for pages 10 & 11.)*

## Page 22 and 23 AC Electronics

CAI-6100	Instructor Management Sys 5.25" Disks	(1 lb)	\$699.95
CAI-6100-03	Instructor Management Sys 3.5" Disks	(1 lb)	\$699.95
CAI-6102-02	AC Electronics CAI-ExTra	(1 lb)	See Below
CAT-6102-01	AC Compr-Aided Troubleshooting	(1 lb)	See Below
EB-6102-A	AC Electronics Text	(2 lbs)	\$24.95
EB-6102-31	AC Electronics Parts Pack	(1 lb)	\$22.95
EB-6102-41	AC Electronics Workbook	(2 lbs)	\$15.95
EB-6102-51	AC Electronics Instructor's Guide	(1 lb)	\$12.95
EB-6102-52	AC Experiment Boards Admin Guide	(1 lb)	\$12.95
EB-6102-71	AC Experiment Boards Workbook	(2 lbs)	\$15.95
EE-3102-B	AC Individual Learning Program (ILP)	(7 lbs)	\$99.95
EEC-3102-03	AC Electronics CAI-LITE 3.5" Disks	(2 lbs)	\$149.95
EEC-3102-05	AC Electronics CAI-LITE 5.25" Disks	(2 lbs)	\$149.95
ETB-6102	AC Pre-wired Experiment Boards	(5 lbs)	\$399.95
ETW-3567	Accessory Backpack	(6 lbs)	\$249.95
ETW-3600	Analog Trainer	(6 lbs)	\$249.95
ET-3600	Analog Trainer (kit)	(6 lbs)	\$149.95
EV-3102-A	AC Electronics Video	(1 lb)	\$59.95

### CAI-ExTra Compr-Aided Troubleshooting

FIRST INSTALLATION	\$400	\$300
2-5 PRICE PER INSTALLATION	\$200	\$150
6+ PRICE PER INSTALLATION	\$100	\$100

*(Pricing assumes that all software is installed at one location. For other situations, please consult with your Heathkit Distributor. Also, see Introductory Special listed with pricing for pages 10 & 11.)*

## Page 24 and 25 Semiconductor Devices

CAI-6100	Instructor Management Sys 5.25" Disks	(1 lb)	\$699.95
CAI-6100-03	Instructor Management Sys 3.5" Disks	(1 lb)	\$699.95
CAI-6103-02	Semiconductors CAI-ExTra	(1 lb)	see below
CAT-6103-01	Semi Computer-Aided Troubleshooting	(1 lb)	see below
EB-6103-A	Semiconductors Text	(2 lbs)	\$24.95
EB-6103-31	Semiconductors Parts Pack	(1 lb)	\$19.95
EB-6103-41	Semiconductors Workbook	(2 lbs)	\$15.95
EB-6103-51	Semiconductors Instructor's Guide	(1 lb)	\$12.95
EB-6103-52	Semi Experiment Boards Admin Guide	(1 lb)	\$12.95
EB-6103-71	Semi Experiment Boards Workbook	(2 lbs)	\$15.95
EE-3103-B	Semi Individual Learning Program (ILP)	(7 lbs)	\$99.95
EEC-3103-03	Semiconductors CAI-LITE 3.5" Disks	(2 lbs)	\$149.95
EEC-3103-05	Semiconductors CAI-LITE 5.25" Disks	(2 lbs)	\$149.95
ETB-6103	Semiconductors Experiment Boards	(4 lbs)	\$299.95
ETW-3567	Accessory Backpack	(6 lbs)	\$249.95
ETW-3600	Analog Trainer	(6 lbs)	\$249.95
ET-3600	Analog Trainer (kit)	(6 lbs)	\$149.95
EV-3103-A	Semiconductors Video	(1 lb)	\$59.95

### CAI-ExTra Compr-Aided Troubleshooting

FIRST INSTALLATION	\$400	\$300
2-5 PRICE PER INSTALLATION	\$200	\$150
6+ PRICE PER INSTALLATION	\$100	\$100

*(Pricing assumes that all software is installed at one location. For other situations, please consult with your Heathkit Distributor. Also, see Introductory Special listed with pricing for pages 10 & 11.)*

Model	Description	Wt	Price
-------	-------------	----	-------

## Page 26 and 27 Electronic Circuits

CAI-6100	Instructor Management Sys 5.25" Disks	(1 lb)	\$699.95
CAI-6100-03	Instructor Management Sys 3.5" Disks	(1 lb)	\$699.95
CAI-6104-02	Electronic Circuits CAI-ExTra	(1 lb)	see below
CAT-6104-01	Circuits Compr-Aided Troubleshooting	(1 lb)	see below
EB-6104-A	Electronic Circuits Text	(2 lbs)	\$24.95
EB-6104-31	Electronic Circuits Parts Pack	(1 lb)	\$39.95
EB-6104-41	Electronic Circuits Workbook	(2 lbs)	\$15.95
EB-6104-51	Electronic Circuits Instructor's Guide	(1 lb)	\$12.95
EB-6104-52	Elect. Circuits Experiment Brd Adm Guide	(1 lb)	\$12.95
EB-6104-71	Elect. Circuits Experiment Board Wkbk	(2 lbs)	\$24.95
EE-3104-B	Electronic Circuits ILP	(7 lbs)	\$99.95
EEC-3104-03	Elect. Circuits CAI-LITE 3.5" Disks	(2 lbs)	\$149.95
EEC-3104-05	Elect. Circuits CAI-LITE 5.25" Disks	(2 lbs)	\$149.95
ETB-6104-A	Electronic Experiment Board	(2 lbs)	\$249.95
ETW-3567	Accessory Backpack	(6 lbs)	\$249.95
ETW-3600	Analog Trainer	(6 lbs)	\$249.95
ET-3600	Analog Trainer (kit)	(6 lbs)	\$149.95
EV-3104-A	Electronic Circuits Video	(1 lb)	\$59.95

### CAI-ExTra Compr-Aided Troubleshooting

FIRST INSTALLATION	\$400	\$300
2-5 PRICE PER INSTALLATION	\$200	\$150
6+ PRICE PER INSTALLATION	\$100	\$100

*(Pricing assumes that all software is installed at one location. For other situations, please consult with your Heathkit Distributor. Also, see Introductory Special listed with pricing for pages 10 & 11.)*

## Page 28 and 29 Electronic Fundamentals

CAI-6100	Instructor Management Sys 5.25" Disks	(1 lb)	\$699.95
CAI-6100-03	Instructor Management Sys 3.5" Disks	(1 lb)	\$699.95
CAI-6101-02	DC Electronics CAI-ExTra	(1 lb)	see below
CAI-6102-02	AC Electronics CAI-ExTra	(1 lb)	see below
CAI-6103-02	Semiconductor Devices CAI-ExTra	(1 lb)	see below
CAI-6104-02	Electronic Circuits CAI-ExTra	(1 lb)	see below
EB-200	Electronic Fundamentals Text	(6 lbs)	\$44.95
EB-200-30	Electronics Fund. Parts Pack	(1 lb)	\$59.95
EB-200-40	Electronics Fund. Workbook	(4 lbs)	\$24.95
EB-200-50	Electronics Fund. Instructor's Guide	(1 lb)	\$12.95
EB-200-52	Elect. Fund. Experiment Brd Adm Guide	(1 lb)	\$12.95
EB-200-71	Elect. Fund. Experiment Brd Lab Manual	(1 lb)	\$24.95
EEC-3101-03	DC Electronics CAI-LITE	(2 lbs)	\$149.95
EEC-3102-03	AC Electronics CAI-LITE	(2 lbs)	\$149.95
EEC-3103-03	Semiconductors CAI-LITE	(2 lbs)	\$149.95
EEC-3104-03	Electronic Circuits CAI-LITE	(2 lbs)	\$149.95
ETB-200	Electronic Fund. Experiment Boards	(4 lbs)	\$399.95
ETW-3567	Accessory Backpack	(6 lbs)	\$249.95
ETW-3600	Analog Trainer	(6 lbs)	\$249.95
ET-3600	Analog Trainer (kit)	(6 lbs)	\$149.95
EV-3101-A	DC Electronics Video	(1 lb)	\$59.95
EV-3102-A	AC Electronics Video	(1 lb)	\$59.95
EV-3103-A	Semiconductors Video	(1 lb)	\$59.95
EV-3104-A	Electronic Circuits Video	(1 lb)	\$59.95

### CAI-ExTra Compr-Aided Troubleshooting

FIRST INSTALLATION	\$400	\$300
2-5 PRICE PER INSTALLATION	\$200	\$150
6+ PRICE PER INSTALLATION	\$100	\$100

*(Pricing assumes that all software is installed at one location. For other situations, please consult with your Heathkit Distributor. Also, see Introductory Special listed with pricing for pages 10 & 11.)*



Model	Description	Wt	Price
<b>Page 30</b>			
<b>Concepts of Electricity</b>			
EB-3100	Concepts of Electricity Text	(3 lbs)	\$24.95
EB-3100-30	Concepts of Electricity Parts Pack	(2 lbs)	\$49.95
EB-3100-40	Concepts of Electricity Workbook	(2 lbs)	\$15.95
EB-3100-50	Concepts of Elect Instructor's Guide	(1 lb)	\$12.95
EE-3100	Concepts of Electricity ILP	(5 lbs)	\$69.95
ETW-3600	Analog Trainer	(6 lbs)	\$249.95
ET-3600	Analog Trainer (kit)	(6 lbs)	\$149.95

<b>Page 31</b>			
<b>Concepts of Electronics</b>			
EB-6140	Concepts of Electronics Text	(3 lbs)	\$34.95
EB-6140-30	Concepts of Electronics Parts Pack	(1 lb)	\$29.95
EB-6140-40	Concepts of Electronics Workbook	(1 lb)	\$15.95
EB-6140-50	Concepts of Elect Instructor's Guide	(1 lb)	\$12.95
EE-3140-A	Concepts of Electronics ILP	(10 lbs)	\$129.95
ETW-3600	Analog Trainer	(6 lbs)	\$249.95
ET-3600	Analog Trainer (kit)	(6 lbs)	\$149.95

<b>Page 32 and 33</b>			
<b>Digital Techniques</b>			
CAI-6100	Instructor Management Sys 5.25" Disks	(1 lb)	\$699.95
CAI-6100-03	Instructor Management Sys 3.5" Disks	(1 lb)	\$699.95
CAI-6201-01	Digital CAI-ExTra	(1 lb)	see below
EB-6201-A	Digital Techniques Text	(3 lbs)	\$29.95
EB-6201-31	Digital Techniques Parts Pack	(1 lb)	\$39.95
EB-6201-41	Digital Techniques Workbook	(2 lbs)	\$15.95
EB-6201-51	Digital Tech Instructor's Guide	(1 lb)	\$12.95
EB-6201-52	Digital Tech Experiment Brd Adm Guide	(1 lb)	\$12.95
EB-6201-71	Digital Tech Experiment Brd Workbook	(1 lb)	\$15.95
EE-3201-A	Digital Individual Learning Program	(10 lbs)	\$149.95
EEC-3201-03	Digital Tech CAI-LITE 3.5" Disks	(2 lbs)	\$149.95
EEC-3201-05	Digital Tech CAI-LITE 5.25" Disks	(2 lbs)	\$149.95
ETB-6201-A	Digital Techniques Experiment Board	(2 lbs)	\$249.95
ETW-3567	Accessory Backpack	(6 lbs)	\$249.95
ETW-3700	Digital Trainer	(6 lbs)	\$249.95
ET-3700	Digital Trainer (kit)	(6 lbs)	\$149.95
EV-3201-A	Digital Videos	(4 lbs)	\$299.95
ETI-7510	Digital Test Set	(2 lbs)	\$99.95

**CAI-ExTra**

FIRST INSTALLATION	\$400
2-5 PRICE PER INSTALLATION	\$200
6 + PRICE PER INSTALLATION	\$100

*(Pricing assumes that all software is installed at one location. For other situations, please consult with your Heathkit Distributor. Also, see Introductory Special listed with pricing for pages 10 & 11.)*

<b>Page 34 and 35</b>			
<b>Microprocessor Programming</b>			
CAI-6100	Instructor Management Sys 5.25" Disks	(1 lb)	\$699.95
CAI-6100-03	Instructor Management Sys 3.5" Disks	(1 lb)	\$699.95
CAI-6810-01	Microprocessors CAI-ExTra	(1 lb)	see below
EB-6810	Micro Program Text 6811	(2 lbs)	\$29.95
EB-6810-30	Micro Program Parts 6811	(3 lbs)	\$49.95
EB-6810-40	Micro Program Workbook 6811	(1 lb)	\$15.95
EB-6810-50	Micro Program Instructor Guide 6811	(1 lb)	\$12.95
EB-8085	Micro Program Text 8085	(3 lbs)	\$29.95
EB-8085-30	Micro Program Parts 8085	(1 lbs)	\$49.95
EB-8085-40	Micro Program Workbook 8085	(2 lbs)	\$15.95

Model	Description	Wt	Price
EB-8085-50	Micro Program Instructor Guide 8085	(1 lbs)	\$12.95
EE-3401-A	Microprocessors Individual Learning	(10 lbs)	\$149.95
EEC-3401-03	Microprocessors CAI-LITE 3.5" Disks	(2 lbs)	\$149.95
EEC-3401-05	Microprocessors CAI-LITE 5.25" Disks	(2 lbs)	\$149.95
ETC-128	Memory Module for the ETW-3800	(2 lbs)	\$99.95
ETC-6811	Motorola 6811 CPU Module for 3800	(2 lbs)	\$199.95
ETC-8085	Intel 8085 CPU Module for ETW-3800	(2 lbs)	\$199.95
ETW-3400-A	Microprocessor Trainer	(6 lbs)	\$499.95
ET-3400-A	Microprocessor Trainer (kit)	(6 lbs)	\$349.95
ETW-3800	Microprocessor Trainer	(6 lbs)	\$599.95
EV-3810-A	Microprocessors Videos	(2 lbs)	\$249.95

**CAI-ExTra**

FIRST INSTALLATION	\$400
2-5 PRICE PER INSTALLATION	\$200
6 + PRICE PER INSTALLATION	\$100

*(Pricing assumes that all software is installed at one location. For other situations, please consult with your Heathkit Distributor. Also, see Introductory Special listed with pricing for pages 10 & 11.)*

<b>Page 36 and 37</b>			
<b>Microprocessor Interfacing &amp; Applications</b>			
EB-6820	Micro Interface Text 6811	(3 lbs)	\$29.95
EB-6820-30	Micro Interface Parts 6811	(2 lbs)	\$99.95
EB-6820-40	Micro Interface Workbook 6811	(2 lbs)	\$15.95
EB-6820-50	Micro Interface Instructor Guide 6811	(1 lb)	\$12.95
EB-6820-52	Experiment Boards Admin Guide	(1 lb)	\$12.95
EB-6820-71	Experiment Boards Workbook	(1 lb)	\$15.95
EBI-8085	Micro Int & App Text 8085	(3 lbs)	\$34.95
EBI-8085-30	Micro Interface & App Parts Pack	(1 lb)	\$99.95
EBI-8085-40	Micro Interface & App Workbook	(2 lbs)	\$19.95
EBI-8085-50	Micro Interface & App. Instr Guide	(1 lb)	\$12.95
EBI-8085-52	Experiment Board Admin Guide	(1 lb)	\$12.95
EBI-8085-71	Experiment Board Workbook	(1 lb)	\$19.95
EE-3402	Micro Interfacing ILP	(10 lbs)	\$149.95
EE-3405	Micro Applications ILP	(10 lbs)	\$149.95
ETB-6820	Microprocessor Experiment Boards	(4 lbs)	\$499.95
ETB-8085	Microprocessor Experiment Boards	(4 lbs)	\$499.95
ETC-128	Memory Module for the ETW-3800	(2 lbs)	\$99.95
ETC-6811	Motorola 6811 CPU Module for 3800	(2 lbs)	\$199.95
ETC-8085	Intel 8085 CPU Module for ETW-3800	(2 lbs)	\$199.95
ETW-3567	Accessory Backpack	(6 lbs)	\$249.95
ETW-3400-A	Microprocessor Trainer	(6 lbs)	\$499.95
ET-3400-A	Microprocessor Trainer (kit)	(6 lbs)	\$349.95
ETW-3800	Microprocessor Trainer	(6 lbs)	\$599.95
EV-3406	Troubleshooting Microprocessors Video	(1 lb)	\$59.95
EV-3810-A	Microprocessors Videos	(2 lbs)	\$249.95

<b>Page 38 and 39</b>			
<b>Master Course In Electronics Technology</b>			
EHS-3100-03	Master Electronics Course 3.5"	(70 lbs)	\$999.00
EHS-3100-05	Master Electronics Course 5.25"	(70 lbs)	\$999.00
EHS-3100-32	Master Course w/SO-4552 3.5"	(92 lbs)	\$1,399.00
EHS-3100-52	Master Course w/SO-4552 5.25"	(92 lbs)	\$1,399.00
EHS-3100-34	Master Course w/SO-4554 3.5"	(92 lbs)	\$1,549.00
EHS-3100-54	Master Course w/SO-4554 5.25"	(92 lbs)	\$1,549.00
EHS-3100-36	Master Course w/SO-4556 3.5"	(92 lbs)	\$1,749.00
EHS-3100-56	Master Course w/SO-4556 5.25"	(92 lbs)	\$1,749.00
EHS-3401-03	Master Crse Microprocessors 3.5"	(107 lbs)	\$1,599.00
EHS-3401-05	Master Crse Microprocessors 5.25"	(107 lbs)	\$1,599.00

Model	Description	Wt	Price
<b>Pages 40 through 45</b>			
<b>PC Servicing, Troubleshooting &amp; Networking Package</b>			
EZS-400	Complete Package PC Servicing, Troubleshooting, and Networking (Includes Two PC Trainers)	(110 lbs)	\$7,495.00
EZS-401	PC Servicing Course	(55 lbs)	\$2,495.00
EZS-402	PC Troubleshooting Course	(55 lbs)	\$2,495.00
EZS-403	PC Networking Course	(105 lbs)	\$5,995.00

<b>Page 46 and 47</b>			
<b>Master Course in Personal Computers</b>			
EHS-6002	Master Course in Personal Computers	(55 lbs)	\$2,495.00

<b>Page 48 and 49</b>			
<b>VCR and Camcorder Servicing</b>			
ET-4010	VCR Servicing Course	(55 lbs)	\$799.00
ET-4020	Camcorder Servicing Course	(15 lbs)	\$1,295.00

<b>Page 50</b>			
<b>TV Servicing</b>			
ET-4001	TV Servicing Course	(70 lbs)	\$699.95

<b>Page 51</b>			
<b>Electronic and Data Communications</b>			
EB-6106	Electronic Communications Text	(1 lb)	\$29.95
EB-6106-30	Electronic Communications Parts	(1 lb)	\$34.95
EB-6106-40	Electronic Communications Workbook	(1 lb)	\$15.95
EB-6106-50	Electronic Comm Instructor's Guide	(1 lb)	\$12.95
EB-8090	Data Comm & Networks Text	(5 lbs)	\$29.95
EB-8090-30	Data Comm & Networks Parts Pack	(1 lb)	\$29.95
EB-8090-40	Data Comm & Networks Workbook	(1 lb)	\$15.95
EB-8090-50	Data Comm & Networks Instr Guide	(1 lb)	\$12.95
EE-3106-A	Elect. Communications ILP	(6 lbs)	\$99.95
EE-8090	Data Comm and Networks ILP	(11 lbs)	\$99.95
ETW-1000	Analog/Digital Trainer	(14 lbs)	\$399.95
ET-1000	Analog/Digital Trainer (kit)	(14 lbs)	\$299.95
ETW-3600	Analog Trainer	(6 lbs)	\$249.95
ET-3600	Analog Trainer (kit)	(6 lbs)	\$149.95

<b>Page 52 and 53</b>			
<b>Laser Technology and Electro-Optics</b>			
EB-610	Laser Technology Text	(2 lbs)	\$24.95
EB-610-30	Laser Technology Parts Pack	(3 lbs)	\$69.95
EB-610-40	Laser Technology Workbook	(1 lb)	\$15.95
EB-610-50	Laser Technology Instructor's Guide	(1 lb)	\$12.95
EE-110	Laser Technology Individual Learning	(7 lbs)	\$129.95
EWS-4200-A	Laser & Receiver	(5 lbs)	\$449.95
ETS-4200	Laser & Receiver (kit)	(5 lbs)	\$349.95

EB-611	Electro-Optics Text	(2 lbs)	\$29.95
EB-611-30	Electro-Optics Parts Pack	(2 lbs)	\$79.95
EB-611-40	Electro-Optics Workbook	(1 lb)	\$15.95
EB-611-50	Electro-Optics Instructor's Guide	(1 lb)	\$12.95
ETW-3700	Digital Trainer	(6 lbs)	\$249.95
ET-3700	Digital Trainer (kit)	(6 lbs)	\$149.95

Model	Description	Wt	Price
<b>Page 54</b>			
<b>Oscilloscopes</b>			
P-150	Scope Probe	(1 lb)	\$44.95
PS-150	2 Scope Probes	(2 lbs)	\$69.95
SO-4552	25 MHz Oscilloscope	(22 lbs)	\$419.95
SO-4554	40 MHz Oscilloscope	(22 lbs)	\$599.95
SO-4556	60 MHz Oscilloscope	(22 lbs)	\$799.95

<b>Page 55</b>			
<b>Multi-Meters, Soldering Course</b>			
EI-3133	Soldering Course	(3 lbs)	\$29.95
GDP-3125	25 Watt Iron	(1 lb)	\$12.95
GHP-1270	Tool Kit	(2 lbs)	\$59.95
SM-2311	Compact DMM	(1 lb)	\$59.95
SM-2372	Hand Held Multimeter	(2 lbs)	\$99.95
SM-2380	Autorange DMM	(2 lbs)	\$89.95
SP-2762	Power Supply	(15 lbs)	\$149.95
ST-100	Tool Kit	(2 lbs)	\$19.95

<b>Page 56</b>			
<b>Advanced Weather Computer</b>			
IDS-5001	Advanced Weather Computer	(25 lbs)	\$1,295.00
IDS-5001-02	Advanced Weather Computer (kit)	(25 lbs)	\$899.95
IDA-5001-01	Humidity Sensor (kit)	(3 lbs)	\$79.95
IDA-5001-02	Rain Gauge Sensor (kit)	(3 lbs)	\$69.95
IDA-5001-03	RS-232 Computer Interface	(1 lb)	\$69.95
IDA-5001-04	Technical Manual	(2 lbs)	\$29.95
IDA-5001-05	PC Compatible Software	(1 lb)	\$59.95
IDA-1290-02	Boom Cable 100 ft.	(4 lbs)	\$22.95

<b>Page 57</b>			
<b>Most Accurate Clock, Clock &amp; Radio Kits</b>			
GCW-1001	Most Accurate Clock II	(7 lbs)	\$349.95
GCW-1001-01	Remote Clock	(7 lbs)	\$149.95
GCS-1001-A	Most Acc Clock II w/Power Interface	(8 lbs)	\$399.95
GCS-1001-B	Most Acc Clock II w/RS-232 Interface	(8 lbs)	\$399.95
GCA-1001-03	10 MHz Dipole Antenna	(6 lbs)	\$49.95
GC-1108	Digital Clock	(4 lbs)	\$39.95
GR-1009	Portable Radio	(2 lbs)	\$39.95

## Additional Courses (Not Advertised In This Catalog)

If you are teaching with a Heathkit course and don't see it advertised in this catalog, please contact your Heathkit Distributor. We continue to supply many of our courses long after we quit actively marketing them.

# CONCEPTS OF ELECTRONICS

## An Applications-Based, Get-Acquainted-Type Course

Yet, this course is hardly light on its breadth of coverage. It provides an overview of a wide range of electronics principles from electron theory to digital computer technology. Students will learn about alter-

nating and direct current, electronic theories, measurements and components. Course materials are enhanced by 26 lab experiments and six unit examinations.

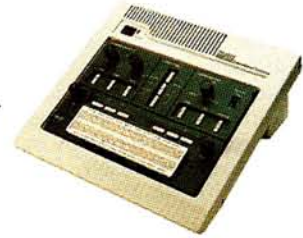

**CONCEPTS OF ELECTRONICS**  
**EB-6140 (Instructor-Led)**  
**EE-3140-A (Individual Learning, 4 CEUs)**



### Course Objectives

#### Direct Current

- State the electrical charge associated with: atom, electron, proton, neutron, nucleus, and ion.
- State Coulomb's law.
- Define: insulator, conductor, current flow, schematic diagram, coulomb, and ampere.
- Identify schematic symbols of basic components.
- Define: electromotive force, potential difference, voltage, and volt.
- State the effects of connecting batteries in series, parallel, and series-parallel.
- Define: resistance, ohm, and conductance.
- Name three types of resistor construction.
- State how total resistance is affected by connecting resistors in series, parallel, and series-parallel.
- Write the three equation forms of Ohm's law. Solve for: current, voltage and resistance.
- Write the basic power formula.
- Find power when any two of the following are given: voltage, current, resistance.
- State the basic law of magnetism.
- Define magnetomotive force, ampere-turn, and permeability.
- Demonstrate the correct way to use a ammeter, voltmeter, and ohmmeter.

### Course Objectives

#### Alternating Current

- Identify a sine wave, and determine peak, peak-to-peak, and rms values of a sine wave.
- Find peak value when given the rms value.
- Define hertz, kilohertz, and megahertz.
- Find wavelength when given frequency.
- Determine phase angle between two sine waves.
- State how a DC meter can be used to measure AC.
- Measure amplitude, period, and frequency using an oscilloscope.
- Define inductance, henry, and mutual inductance.
- Solve problems involving the turns ratio of transformers.
- State why impedance matching is important.
- Name two sources of loss in a transformer.
- Define inductive reactance, impedance, capacitance, farad, and capacitive reactance.
- Write the formula for inductive reactance, capacitive reactance, and resonance.
- Find inductive reactance when given frequency and inductance.
- Find the total inductance of series and parallel connected inductors.
- State the phase angle between voltage and current in an inductor, and in a capacitor.
- Find the impedance of a series RL circuit.
- State the factors which determine capacitance.
- Find the total capacitance of series and parallel connected capacitors.
- Find capacitive reactance when given frequency and capacitance.
- Find the impedance of a series RC circuit, a series RLC circuit, and a parallel RLC circuit.
- Define resonance.
- Characterize series and parallel resonant circuits.
- Define circuit Q and state its effect on the bandwidth of a resonant circuit.
- List four types of filters and state their purposes.

#### Active Devices

- Differentiate between P-type and N-type semiconductors.
- Identify both forward and reverse-biased diodes.
- Name the two most important solid-state diode ratings and define each one.
- State the characteristics of zener and varactor diodes.
- Draw the schematic symbols for the diode, zener diode, varactor diode, NPN and PNP transistors.
- Name the three sections of a transistor and identify them on a transistor schematic symbol.
- State the correct bias for the junctions of a transistor.
- Identify and characterize the common-emitter, common-base, and common-collector amplifiers.
- Define beta, thermal runaway, and maximum power dissipation as applicable to transistors.
- Identify the schematic symbols of a JFET, a depletion mode MOSFET, and an enhancement mode MOSFET.
- State the difference between depletion and enhancement mode MOSFETs.
- State the characteristics of basic FET circuits
- Define light, infrared rays, ultraviolet rays and photon.
- State the light spectrum's frequency range.
- Name four light sensitive devices, state the characteristics of each, and identify their schematic symbols.
- Determine the necessary value of bias resistor for correct LED operation.
- Explain the operation and modes of the light emitting diode (LED) and the liquid crystal display (LCD).

- Define integrated circuit and list its advantages.
- State the basic types and characteristics of digital ICs, linear ICs, and operational amplifiers.

#### Electronic Circuits

- Identify half-wave, full-wave, and bridge rectifiers. State the ripple frequency and voltage polarity present at the output of each.
- State the purpose of a power supply filter.
- Determine the peak inverse voltage a diode is subjected to in a rectifier circuit.
- State how you can obtain a higher PIV.
- Identify diode protection circuitry and its operation.
- State why electrolytic capacitors are used in power supply filters.
- Define "capacitor working voltage rating," and state how you can increase it.
- Identify voltage doubler circuits.
- State the two purposes of a bleeder resistor.
- Identify zener diodes and IC voltage regulators.
- List two types of audio amplifiers.
- Find the gain or loss in decibels when given two power, voltage, or current levels.
- Identify four types of audio amplifier coupling circuits.
- Define class A, B, AB, and C amplifier operation.
- Find amplifier efficiency, given input and output power.
- Name the basic operational amplifier terminals and state their function.
- List the characteristics of an ideal operational amplifier.
- Identify basic op amp circuits and determine their gain.
- Identify three types of coupling used in RF amplifiers.
- State the requirements for an oscillator.
- Identify and explain the operation of Armstrong, Hartley, Colpitts, and crystal oscillators.

#### Digital Electronics

- State why the binary number system is used.
- Convert between the decimal, binary, and BCD numbers.
- Identify six basic logic gates, and write the truth table and logic expressions for each.
- Define the term "flip-flop" and name three basic types.
- Identify the logic diagrams of basic flip-flops.
- Explain the basic operation of three types of flip-flops.
- Describe sequential logic circuits.
- Identify binary up, binary down, and BCD counters.
- Explain the operation of counters and shift registers.
- Determine the output pulse duration of 555 mono-stable and astable multivibrators.

#### Digital Computers

- Define digital computer, data, instructions, program, software, and peripheral unit.
- Define the four major sections of a digital computer.
- Define computer instruction, address, central processing unit, accumulator, and interrupt.
- List the seven steps of computer programming.
- Define machine language programming, algorithm, flow chart, coding, and loop.
- Analyze a program, when given the instruction set.
- Define subroutine, assembler, compiler, cross-assembler, cross compiler, and utility program.
- State the primary use and applications of the micro-processor.
- List the benefits of using a microprocessor over a hard-wired logic system.
- Write a simple microprocessor program when given the problem and computer instruction set.

SUBJECT	TRAINER	PARTS PACK	TEXT	WORKBOOK/ LAB MANUAL	INST GUIDE/ ADMIN GUIDE	IND. LEARNING PROGRAM
CONCEPTS OF ELECTRONICS (Instructor-Led/with Parts Packs) (Individualized Learning)	ETW-3600 ETW-3600	EB-6140-30	EB-6140	EB-6140-40	EB-6140-50	EE-3140-A

For Pricing, See Center of Catalog

# DIGITAL TECHNIQUES COURSES

The Digital Techniques course introduces the technological principles of logic circuits, digital integrated circuits, Boolean algebra, memory devices, data conversion, flip-flops and registers, sequential logic circuits, combinational logic circuits and more. In 26 hands-on experiments students design, build and analyze a wide variety of digital-

circuits, and learn to troubleshoot digital circuits using standard test equipment.

In our CAI courses, students will explore number conversions and codes, and work with gates on-screen. Students will single-step logic circuits and registers—even watch logic within decoders, and see data conversion happen real-time.

**Course Objectives** (Varies slightly depending on media selected)

## COMPUTER-AIDED INSTRUCTION

CAI-6201-01 (CAI-ExTra)

EEC-3201-03 (CAI-LITE, earn 1 CEU)

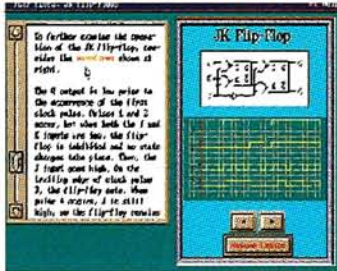

## Introduction to Digital Techniques

- Given a list of physical variables, components, devices, and other items, classify them as being either analog or digital.
- List at least five advantages of digital circuits over analog circuits.
- List at least five examples of electronic equipment using digital circuits.
- State the factors influencing the growing use of digital equipment.
- Convert numbers between the decimal, binary, and binary coded decimal number systems.
- List four popular digital codes and the two key ways binary data is represented with digital hardware.
- State the advantages and disadvantages of both serial and parallel methods of binary data transmission.
- Identify binary signals as being either positive or negative logic.

## DIGITAL TECHNIQUES COURSE

EB-6201-A (Instructor-Led)

EE-3201-A (Individual Learning, 4 CEUs)



## Semiconductor Devices for Digital Circuits

- Name the two types of semiconductor elements used in digital circuits and list the advantages and disadvantages of each.
- Identify from a list the symbols used to represent PNP and NPN bipolar transistors and P- and N-channel enhancement mode MOSFETs.
- Explain the operation of both bipolar transistors and MOSFETs.
- Name and explain the three operating modes of a bipolar transistor.
- Determine the proper bias on a bipolar transistor for saturated operation.
- Explain the operation of a logic inverter circuit.
- Design a saturated bipolar transistor switching circuit.

## Digital Logic Circuits

- List the three basic types of logic elements.
- Write a definition for combinational and sequential logic circuits.
- Draw the schematic and explain the operation of both diode and switch contact AND gates, OR gates, and logic level inverters.
- Given a list of symbols, identify the industry standard symbols for inverters, AND, OR, NAND, and NOR gates.
- From a list of truth tables, identify the logic functions being performed.
- Write a truth table for the logic functions: AND, OR, NOT, NAND, NOR.
- Given a list of logic equations, identify the logic function expressed by each.
- Write the logic equation for logic functions AND, OR, NAND, NOR, NOT.

## DIGITAL TECHNIQUES VIDEO

EV-3201-A

We've condensed 25 VHS tapes used in university classrooms—and drastically reduced the price! It provides the same content in six 2-hour tapes. It starts with the fundamentals, then moves on to common logic circuits, Boolean algebra, flip-flops, registers, combinational logic circuitry and digital design. Students learn to identify various types of semiconductor memories and data conversions, learn how they operate and how they're used.

## Digital Integrated Circuits

- Name the two types of semiconductor switching elements used in digital circuits.
- Define the four basic logic circuit characteristics of propagation delay, power dissipation, noise immunity and fan out.
- Identify basic types of digital IC packages.
- Name four distinct families of digital ICs.
- Differentiate between current source and current sink logic circuits.
- Describe the detailed operation and capabilities of TTL, ECL, MOS, CMOS, and IIL integrated circuits given a schematic of the circuit.

## DIGITAL TROUBLESHOOTING

TEST SET & COURSE

ETI-7510



- Engineers, scientists, technicians, students and electronics hobbyists all need to know how to test and troubleshoot the complex circuits of today. The key to digital troubleshooting is to do it quickly and efficiently. The Heathkit Digital Test Set provides both the tools and the know-how to accomplish this.
- You get a pulser/probe set and 4 spring-loaded IC clips with gold-plated

### TEACHING/LEARNING PACKAGE OPTIONS

Instructor-Led/Pre-wired Boards/Textbook  
 Instructor-Led/Pre-wired Boards/CAI ExTra  
 Instructor-Led/Parts Packs/Textbook  
 Instructor-Led/Parts Packs/CAI LITE  
 Individualized Learning ILP & CAI LITE

### TRAINER

ETW-3700  
 ETW-3700  
 ETW-3700  
 ETW-3700  
 ETW-3700

### BACKPACK

ETW-3567  
 ETW-3567

### BOARDS/ MODULE

ETB-6201-A  
 ETB-6201-A

### PARTS PACK

EB-6201-31  
 EB-6201-31

Ordering Numbers

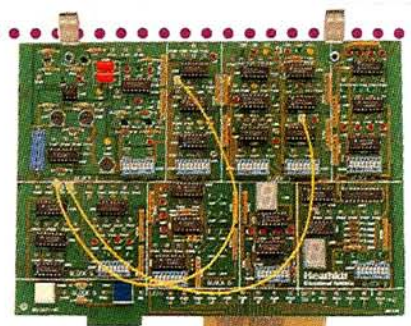
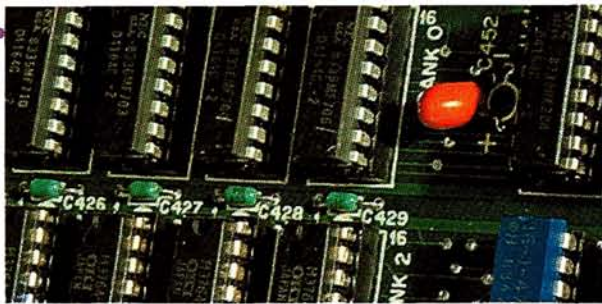

## Course Objectives

- Select a type of digital IC to implement a given application for optimum performance and economy.

## Boolean Algebra

- Define Boolean algebra, and write the Boolean expression corresponding to a given logic circuit.
- Draw the symbolic logic circuit implementing or corresponding to a given Boolean expression.
- Write the Boolean expression corresponding to a truth table.
- Give an example of each of the two basic types of Boolean expressions (sum-of-products and product-of-sums).
- Minimize a logic expression using the rules of Boolean algebra.
- Implement a Boolean expression with NAND or NOR gates.
- Write the two versions of DeMorgan's theorem.
- Write the Boolean expression of logic circuits using the wired AND connection.

## Flip-Flops and Registers

- Write a definition for a flip-flop, a register, and name the three basic types of flip-flops.
- Given a logic diagram, identify each of the three types of flip-flops from their symbols or logic gate connections.
- Explain the operation of RS, D, and JK flip-flops, showing the output states for all possible input states.
- Given a set of input waveforms for the RS, D or JK flip-flop, recognize the corresponding output waveforms.
- Give a practical application for the three types of flip-flops.
- Given a register made with any type of flip-flop, measure the output states and determine the binary number stored there.

## Sequential Logic Circuits: Counters, Shift Registers, and Clocks

- Name the two most widely used types of sequential logic circuits.
- Explain the operation of both binary and BCD counters.
- Determine the maximum count capability of a binary or BCD counter, given the number of flip-flops.
- Determine the count sequence of a counter from a logic diagram and draw the circuit waveforms.
- Explain the operation of and applications for a shift register.
- Explain the purpose of the clock signal and show a method of developing it.
- Explain the operation of a one-shot and list several applications.

pins. The clips fit virtually any common dip integrated circuit and give you easy access to the IC pins.

- The accompanying 90 page text shows you how to use the logic pulser and probe to test and troubleshoot digital circuits quickly, easily and safely.
- Also covered is how to troubleshoot using other common test instruments.

## Course Objectives

### Combinational Logic Circuits

- Name at least seven different types of standard combinational or functional logic circuits.
- Write the output states of a decoder, encoder, multiplexer, and demultiplexer, given the input states.
- Implement a decoder with NAND or NOR gates.
- Name two applications for a multiplexer circuit.
- Write the output states of an exclusive OR and an exclusive NOR circuit given the input states.
- List three applications for the exclusive OR gate.
- Explain the operation of read only memory and list three applications.
- Define a programmable logic array.

### Semiconductor Memories

- Draw a block diagram of the hierarchy of semiconductor memories.
- Describe the organization of random access read/write and read only memories.
- Name the two major types of read/write memories, describe how they operate, and compare their characteristics and applications.
- Name the types and explain the operation of programmable read only memories.

### Data Conversions

- Name two reasons why it is desirable to convert from one form of data to another.
- Explain two basic methods of digital-to-analog conversion.
- Name and explain the error sources in digital-to-analog conversion.
- List four different types of analog-to-digital conversion.
- Explain how sampling rate affects data conversion accuracy.
- Name and explain the error factors in analog-to-digital conversion.
- Define the term "time division multiplexing" and explain how an analog multiplexer works.
- Define and explain the operation of a sample/hold circuit.

### Digital Troubleshooting

- Name the common causes of digital equipment malfunction.
- Explain how and why digital circuits fail.
- List the test equipment used to troubleshoot digital circuits.
- Show how to troubleshoot digital circuits using common test instruments such as the VOM/DMM and the oscilloscope.
- Explain the operation and application of logic probes, logic pulsers, logic analyzers, and signature analyzers.
- List several common procedures for diagnosing and isolating circuit problems.

TEXT	WORKBOOK/ LAB MANUAL	INST GUIDE/ ADMIN GUIDE	IND.LEARNING PROGRAM	CAI	INST MGMT	VIDEO (optional)
EB-6201-A	EB-6201-71	EB-6201-52				EV-3201-A
EB-6201-A	EB-6201-41 EB-6201-41	EB-6201-51 EB-6201-51		CAI-6201-01 EEC-3201-03 EEC-3201-03	CAI-6100-03	EV-3201-A EV-3201-A EV-3201-A EV-3201-A
			EE-3201-A			

For Pricing, See Center of Catalog

# MICROPROCESSOR PROGRAMMING

This first course in the microprocessor series is an industry standard, providing a solid foundation in MPU architecture and general microprocessor basics. Students begin by reviewing number systems and codes; progress on to computer arithmetic and programming; and then get into how to interface microprocessors to communicate with RAM, ROM and various input/output devices such as the PIA or the MUART. In our CAI, students will see animations of data moving through the MPU, Memory, and the Bus. Students will interact directly with on-screen graphics demonstrating register and memory operations, write and decode program instructions, and much more.

**Motorola  
6800  
Family**

**Intel 8085**

Course Objectives (Varies slightly depending on media selected)

## COMPUTER-AIDED INSTRUCTION

CAI-6810-01 (CAI-ExTra)

CAI-3401-03 (CAI-LITE, earns 1 CEU)



## MICROPROCESSOR PROGRAMMING

EB-6810 OR EB-8085 (Instructor-Led)

EE-3401-A (Individual Learning, 8 CEUs)



## Microcomputer Basics

- Recognize and explain the differences between a microprocessor and microcomputer.
- Define the terms: microprocessor, microcomputer, input, output, I/O device, I/O port, instruction, program, stored program concept, word, byte, MPU, ALU, operand, memory, address, read, write, RAM, fetch, execute, mnemonic, opcode, and bus.
- Explain the purpose of the following circuits in a typical microprocessor: accumulator, program counter, instruction decoder, controller sequencer, data register, and address register.
- Using a simplified block diagram of a hypothetical microprocessor, trace the data flow that takes place between the various circuits during the execution of a simple program.
- Write simple, straight-line programs that can be executed by the Microprocessor Trainer.

## Addressing Modes

- Describe the difference between inherent, immediate, and direct addressing.
- Explain the main features of inherent or implied addressing.
- Define MPU cycle.
- Discuss addressing modes in terms of MPU cycles.
- Explain the main features of the direct addressing mode.
- Demonstrate the use and characteristics of different addressing modes by writing and analyzing assembly language programs.

## Introduction to Programming

- Explain the difference between machine language, assembly language, interpretive language, and compiler language.
- Define computer program, instruction set, opcode, mnemonics, and BASIC.
- Draw the symbols used in flow charting and explain the purpose of each.
- Develop flow charts that illustrate step-by-step procedures for solving simple problems.
- Explain the purpose of conditional and unconditional branching.
- Using the block diagram of the hypothetical microprocessor, trace the data flow during execution of a branch instruction.

## MICROPROCESSOR OPERATION VIDEO EV-3810-A

A six-hour video series covering 6800 family programming, interfacing, and applications.

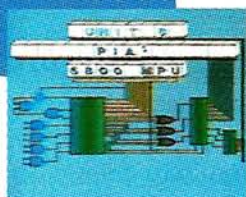

### SUBJECT

Motorola 6800 family (Instructor-Led/Textbook)  
Motorola 6800 family (Instructor-Led/CAI ExTra)  
Intel 8085 (Instructor-Led/Textbook)  
Motorola 6800 family (Individual Learning)

### TRAINER

ETW-3800\*  
ETW-3800\*  
ETW-3800\*  
ETW-3400-A

### MPU MODULE

ETC-6811  
ETC-6811  
ETC-8085

### PARTS PACK

EB-6810-30  
EB-6810-30  
EB-8085-30

### TEXT

EB-6810  
EB-8085

\*Also available is the **ETC-128 Memory Module**. Allows students to save their programs individually.

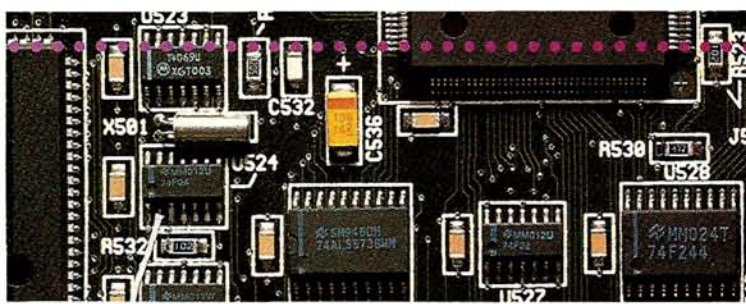

Course Objectives

- Compute the proper relative address for branching forward or backward from one point to another in a program.
- Explain the purpose of the carry, negative, zero, and overflow flags. Give an example of a situation that can cause each to be set, and another example that will cause each to clear. List eight instructions that test one of these flags.
- Write programs that can: multiply by repeated addition; divide by repeated subtraction; convert binary to BCD; convert BCD to binary; add multiple-precision numbers; subtract multiple-precision numbers; add BCD numbers.

## Microprocessor Architecture and Instruction Set

- Draw a programming model of the MPU used in the trainer.
- Explain the purpose of each block in a simplified block diagram of the MPU.
- Using appendixes and figures supplied as references, explain the operation of all the instructions described.
- Write simple programs that use indexed and extended addressing.
- Given an instruction and related figures, find the opcode, number of machine cycles, number of bytes, and how the execution of the instruction affects the condition code register.

## Stack Operations

- Define stack, stack operation, stack pointer, cascade stack, and memory stack.
- Write simple programs that can store data in and retrieve data from the stack.
- Write programs that use the stack and indexing registers to move a list from one place in memory to another.
- Explain the operations performed by the Push/Pull stack instructions and the stack pointer instructions.

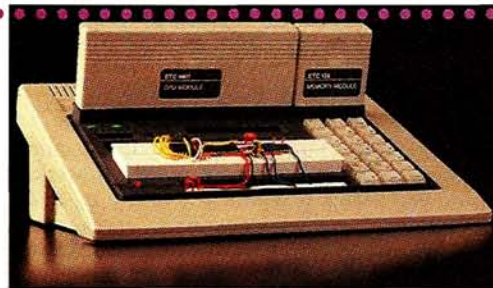

Course Objectives

## Double Accumulator\* and Subroutine Instructions

\*(covered in 6810 course only)

- Describe the operation of the 16-bit, double "D" accumulator in the 68HC11 microprocessor.
- Use the D-accumulator to perform arithmetic and data handling operations.
- Define the term subroutine as applied to programming.
- Explain how subroutines are used in programs.
- Give general examples of programming situations in which the use of a subroutine would be appropriate.

## Input/Output and Interrupt Operations

- Define input/output or I/O as it applies to microprocessors and computers.
- State the two main methods of I/O operations in microprocessors.
- Describe the difference between accumulator and memory-mapped I/O operations.
- Give a brief definition of the phrase "microprocessor interface."
- Outline, in simple block diagram form, the main elements of a microcomputer I/O interface.
- Describe a simplified microprocessor interface output and input circuit.
- Explain briefly what is meant by I/O programming.
- Give an example of an I/O program for a microprocessor.
- Define the term interrupt, as it applies to programming.
- Outline the memory allocations in a typical microcomputer system. Include RAM, ROM, EPROM, EEROM, and I/O.
- Describe the basic operation of the various types of resets and hardware and software interrupts.
- Calculate the Reset Delay Time (TRD) for the MPU, given the crystal oscillator frequency or the E-Clock frequency.
- Describe what is meant by a Non-Maskable Interrupt.
- Explain the Interrupt Processing Priority of the MPU.
- Determine which interrupt will be processed first in the event of simultaneous interrupt requests.

**WORKBOOK/  
LAB MANUAL**

EB-6810-40

EB-8085-40

**INST GUIDE/  
ADMIN GUIDE**

EB-6810-50

EB-8085-50

**IND.LEARNING  
PROGRAM**

EE-3401-A

**CAI**

CAI-6810-01

EEC-3401-03

**INST MGMT**

CAI-6100-03

**VIDEO  
(optional)**

EV-3810-A

EV-3810-A

EV-3810-A

EV-3810-A

# MICROPROCESSOR INTERFACING & APPLICATIONS

**Motorola 6800 Family**  
**Intel 8085**

Microprocessors must be interfaced to memory and I/O devices to carry out computing and applications functions, and that's what this course is all about. It shows how to interface memory for program storage and I/O devices for system communication. It teaches how to apply the microprocessor to real tasks through analog con-

version, serial data communications, memory devices, programmable timers, signal conditioning, sensors, motors, control devices and control circuits. It covers display multiplexing, I/O control, handshaking, and much more.

It also provides insight into current and possible future applica-

## Course Objectives (Varies slightly depending on media selected)

**MOTOROLA INTERFACING & APPLICATIONS COURSE**  
EB-6820 (Instructor-Led)  
EE-3402 &  
EE-3405 (Individual Learning, 15 CEUs)  
**INTEL INTERFACING & APPLICATIONS COURSE**  
EBI-8085 (Instructor-Led)

### Interfacing Basics and the MPU

- Explain the bus structure of a typical microprocessor system.
- Define 3-state logic and explain the need for it.
- Explain the timing relationships between the clock signals and the information on the address, data, and R/W lines.
- Draw the logic diagram of a simple address decoder.
- Show different methods to drive a 7-segment display with an MPU.
- Diagram how mechanical switches can be connected to an MPU.
- Explain how the MPU can eliminate the effects of contact bounce.
- Explain the operation of a program that detects contact closure of switches, provides for switch debouncing, and decodes a keyboard.
- Sketch a block diagram and briefly explain the internal hardware features of the MPU.

### A Programmable Interface Device - the PIA for Motorola, or the MUART for Intel

- Draw a simplified block diagram of the interface device, and explain the purpose of the data, control, and data direction registers.
- Write a simple program that will configure the interface device in any desired input/output combination.
- Explain how the interface device can be used to drive displays and encode keyboards.
- Use the interface device control lines to communicate with external devices.
- Write programs to initialize the interface device for several I/O control applications (polling, complete handshaking, partial handshaking).
- Perform input and output handshakes using the interface device control lines.

### Serial Data Communications

- Describe how serial data can be represented using both amplitude and frequency modulation techniques.
- Explain the difference between asynchronous and synchronous serial data transmission.
- Define what is meant by the term "baud rate" and how this term is applied to serial data communication.
- List three different methods for channeling serial data.
- Make parallel/serial conversions using the interface device.
- Outline the steps necessary for software conversion of serial data to parallel data and parallel data to serial data.
- Define the difference between a UART, USRT, and USART.
- Describe the internal structure and register functions of the Asynchronous Communications Interface Adapter (ACIA). *(for Motorola)*
- Interface to the ACIA. *(for Motorola)*
- Initialize and operate the ACIA to perform parallel/serial data conversions. *(for Motorola)*
- Describe the structure and operation of the internal 68HC11 SCI.



### MICROPROCESSOR OPERATION VIDEO EV-3810-A

A six-hour video series covering 6800 family programming, interfacing, and applications.

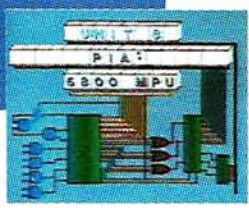

### MICROPROCESSOR TROUBLESHOOTING VIDEO EV-3406

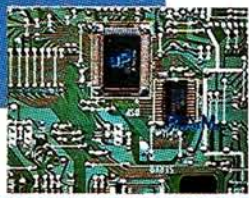

- This 45-minute video is the perfect applications-based follow-up to the microprocessor programming, and interfacing and applications courses. It puts to use many of the concepts learned into real-world perspective.
- The tape reviews the general concepts of microprocessors then discusses, in detail, troubleshooting and applications of microprocessors in today's consumer electronics devices.

SUBJECT	TRAINER	BACKPACK	MPU MODULE	EXPERIMENT BOARDS
Motorola 6800 Family (Instructor-Led/Pre-wired Boards)	ETW-3800*	ETW-3567	ETC-6811	ETB-6820
Motorola 6800 Family (Instructor-Led/Parts Packs)	ETW-3800*		ETC-6811	
Intel (8085) (Instructor-Led/Pre-wired Boards)	ETW-3800*	ETW-3567	ETC-8085	ETB-8085
Intel (8085) (Instructor-Led/Parts Packs)	ETW-3800*		ETC-8085	
Motorola 6800 Family (Individual Learning)	ETW-3400-A			

\*Also available is the **ETC-128 Memory Module**. Allows students to save their programs individually.



tions, describes data converters, transducers, and phase-locked loops. Students will construct several microprocessor controlled devices, including a microprocessor/stepper motor interface with a control circuit, and a programmable digital frequency synthesizer.



Experiment  
Circuit  
Boards  
ETB-6820  
ETB-8085

## Course Objectives

### Memory

- Describe the hardware and software required to program an EPROM.
- Explain how to interface to a ROM device and read its contents.
- Describe how to interface to static RAM devices.
- Explain the interfacing requirements of dynamic RAM.
- Outline the internal memory features of the 68HC11.
- Explain how to use the internal 68HC11 RAM, ROM and EEPROM.

### Programmable Timers

- Explain the function and structure of a programmable timer.
- Describe the internal structure and register functions of the Programmable Timer Module (PTM).
- Explain the function of the PTM I/O lines.
- Interface the PTM to a microprocessor-based system.
- Address and initialize the PTM.
- Generate time delays, continuous waveforms, and one-shot pulses using the PTM.
- Measure the period and/or pulse width of an externally applied signal using the PTM.
- Measure the time between two external events using the PTM.
- Initialize the PTM to perform the above mentioned timing tasks.
- Explain how to use the internal 68HC11 timer.

### Analog Converter

- Interface a D/A converter to a microprocessor system.
- Write programs to generate waveforms from a microprocessor controlled D/A converter circuit.
- Describe how a multiplying D/A converter circuit can amplify or attenuate analog signals under control of a microprocessor.
- Describe how D/A converters are used to control the direction of rotation, speed, and position of DC motors.
- Define the function of a servo amplifier in a motor control circuit.
- Interface parallel output A/D converters and V/F converters to a microprocessor via the interface device.
- Describe how an interface device is used to provide handshake control of the analog conversion process of a parallel output A/D converter.
- Write a program to count pulses generated by a V/F converter.
- Describe the circuit requirements of a typical data acquisition system.
- Describe how sample/hold devices and analog multiplexers are used with A/D converters in a data acquisition system.
- Describe and provide an example of a microprocessor-based industrial control system.

### Temperature and Optical Sensing

- Explain the operating principles of RTD, thermistor, thermocouple, and semiconductor type temperature sensors and transducers.

- It also serves as a handy refresher for those involved in occasional microprocessor troubleshooting.

## Course Objectives

- Construct a microprocessor-controlled thermometer.
- Calculate the resistance of RTDs and thermistors from given temperature coefficient and sensitivity values.
- Explain the operating principles of photoresistive, photovoltaic, and photoemissive devices.
- List advantages and disadvantages of several different types of temperature and optical sensors.
- Compare the application merits of photodiodes and phototransistors.
- State several sensing applications for optical interrupter and optical reflector devices.
- Explain why optocouplers are used for electrical isolation.

### Position, Proximity and Force Sensing

- Describe several common techniques used to measure the following mechanical phenomena: position, motion, and force.
- Design magnetic detection circuits using magnetic reed switches and Hall effect devices.
- Define stress and strain.
- State the three general types of stress/strain situations.
- Explain how resistive strain gages are used to measure force.
- Define and calculate the gage factor for a resistive strain gage.

### Control Devices and Circuits

- Design a microprocessor-controlled SCR or TRIAC circuit.
- Explain how a microprocessor can control the effective current to a load using an SCR or TRIAC.
- State the advantages of using an opto-isolator in a microprocessor control circuit.
- List at least three considerations that must be taken into account when you are using solid-state relays to control high current loads.
- Explain how to control the speed of the various types of DC motors.
- Describe the operation of bipolar and unipolar stepper motors.
- Explain how to control the direction of rotation, amount of rotation, and speed of a stepper motor.
- Design and explain a microprocessor/stepper motor interface and control circuit.

### Microprocessor Applications

- Describe the two marketing directions that have been taken by the microprocessor applications industry.
- Explain how a microprocessor is used to control exhaust emissions and fuel economy in an automobile.
- State the features of a microprocessor-based weather station.
- List several consumer product applications of a microprocessor.
- Explain how multiple microprocessors are utilized in advanced personal computer and business systems.
- List the three major sections of an intelligent robot, and the three major categories of industrial robots.
- Define and describe sensory feedback, CAD/CAM, and FMS.
- List at least three advantages of using a CAD/CAM system in a manufacturing process.
- Describe a typical flexible manufacturing system.
- Suggest several microprocessor applications in the aviation and medical industries.
- Explain several business applications of microprocessors, including small business computers, word processors, copiers, cash registers, and inventory control systems.

PARTS PACK	TEXT	WORKBOOK/	INST GUIDE/ LAB MANUAL	IND. LEARNING PROGRAM	VIDEO (OPTIONAL)
EB-6820-30	EB-6820	EB-6820-71 EB-6820-40	EB-6820-52 EB-6820-50		EV-3810-A & EV-3406 EV-3810-A & EV-3406
EBI-8085-30	EBI-8085	EBI-8085-71 EBI-8085-40	EBI-8085-52 EBI-8085-50		EV-3810-A & EV-3406 EV-3810-A & EV-3406

EE-3402 & EE-3405

EV-3810-A & EV-3406



For Pricing, See Center of Catalog

# MASTER COURSE IN ELECTRONICS TECHNOLOGY



Designed for Individual Learning, this professional-level program in electronics has all the ingredients for mastering the technology.

## Fast-Track Learning

Our video and Computer-Aided Instruction tools deliver unprecedented high-speed learning. You get the knowledge and skills faster and easier. But at the same time, set your own pace and choose your own schedule. With demanding work schedules, many students turn to Heathkit Individual Learning Programs to master electronics—fast, and in the comfort of their own home or office.

## Enjoyable Multimedia Experience

Most people don't want to learn by just reading. Besides, learning by one method alone simply doesn't have the impact of a multimedia learning program. That's why the Master Course in Electronics Technology provides so many different ways to learn.

Instead of reading for hours on end, you will read a few pages, complete a self-test review, watch a video clip, interact with a computer, and build a circuit as part of an experiment. And the Master Activity Guide leads you through each "bite-size" step of the program. The varied activities keep learning fun and exciting while also increasing comprehension.

## Video

Six VHS video tapes make learning as simple as watching your favorite TV program. But more importantly, it's been proven that one hour of fully animated, full-color video demonstrations can be as effective as four hours of classroom instruction.

## Computer-Aided Instruction

The DOS-based computer (not supplied) becomes the most powerful learning tool imaginable with four Computer-Aided Instruction programs. Naturally, subjects are explained in easy-to-understand terms. But what will amaze and delight each student is the transformation of each concept into animated, full-color graphics and demonstrations that anyone can

This complete, state-of-the-art electronics program is by far the easiest ... most affordable ... and comprehensive way there is to learn and excel in electronics — even if you're brand new to the field.

## Comprehensive and Inexpensive

This program is priced unbelievably low compared to all the competition. No one in the industry can begin to match the quality and value offered by Heathkit. Just look at everything you get with your complete package:

- Basic Electronics Series Individual Learning Programs: DC, AC, Semiconductor Devices and Electronic Circuits
- Soldering Course and Video
- All four Basic Electronics Series Videos
- Computer-Aided Instruction (CAI-LITE) self-study programs for each of the four Basic Electronics courses
- Troubleshooting with the Oscilloscope video
- Digital Techniques Individual Learning Program
- Heathkit Analog and Digital Trainers as kits
- Digital Multimeter
- Complete tool kit for performing course experiments and assembling kit trainers

## Superior Instruction, Better Value

Compare our state-of-the-art Individual Learning Programs with home study courses offered by others. Not only do we deliver superior instruction, more (and better quality) equipment, and a bigger variety of learning experiences ... we do it at a fraction of our "competitors" prices!

For Pricing, See Center of Catalog

understand and remember. These programs teach, demonstrate, illustrate and check your understanding of all major principles presented with more than 40 fun-filled hours of in-depth instruction, vivid graphics, and unequalled demonstrations.

## State-Of-The-Art-Trainers

You will build real electronic circuits with Heathkit Analog and Digital Trainers. Both trainers are electronic kits that you build and use as part of the course experiments.

## Hands-On Experiments

Enjoy a pleasant change of pace with hands-on experiments. Each course offers opportunities to practice what is read, watched on video and worked on at the computer. Complete packages of parts and components needed to perform the experiments are included with the texts.

## World-Famous Texts

Of course, there's the world-famous Heathkit Educational Systems texts. Each one has been written by experts in their fields and updated as technology changes. The texts are based on clearly stated objectives with simple step-by-step instructions. Frequent quizzes are included to check understanding. These texts are the cornerstone of your Master Course in Electronics Technology.

## Earn Real CEU Credit

You will earn 9 intermediate certificates of completion and accumulate 25 Continuing Education Units (CEU's) of credit as you progress through the program. At each milestone, you have tangible proof of your accomplishment. And when the entire program is successfully completed, including the comprehensive Master Examination, Heathkit Educational Systems will send you a magnificent presentation-grade certificate of completion that you can proudly display in your office or home.

### What you get:

- Soldering Course
- Soldering Video
- DC Electronics Individual Learning Program
- DC Electronics CAI-LITE Program
- DC Electronics Video
- AC Electronics Individual Learning Program
- AC Electronics CAI-LITE Program
- AC Electronics Video

- Semiconductor Devices Individ. Learning Program
- Semiconductor Devices CAI-LITE Program
- Semiconductor Devices Video
- Electronic Circuits Individual Learning Program
- Electronic Circuits CAI-LITE Program
- Electronic Circuits Video
- Analog Trainer Kit
- Digital Techniques Individual Learning Program
- Digital Trainer Kit
- Digital Multimeter
- 10 Piece Tool Kit
- Troubleshooting with the Oscilloscope Video
- Hundreds of Electronic Components
- 9 Intermediate Graded Examinations
- Master Activity Guide\*
- Master Examination\*
- University-grade Certificate of Completion\*

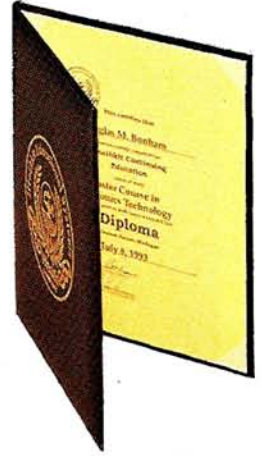

\* These are features that are not available any other way.

### What you need:

- IBM PC compatible computer and oscilloscope

### Master Course (DC through Digital)

EHS-3100-03 3.5" disks

EHS-3100-05 5.25" disks

### Add the SO-4552 25Mhz Oscilloscope

EHS-3100-32 3.5" disks

EHS-3100-52 5.25" disks

### Add the SO-4554 40Mhz Oscilloscope

EHS-3100-34 3.5" disks

EHS-3100-54 5.25" disks

### Add the SO-4556 60Mhz Oscilloscope

EHS-3100-36 3.5" disks

EHS-3100-56 5.25" disks

### Add Microprocessors to your Master Course

Add the EE-3401-A Microprocessor Theory and Operations course, the EE-3402 Microprocessor Interfacing course, the EE-3405 Microprocessor Applications course, the ET-3400-A Trainer (kit), and complete Activity Guide. Upon completion, you will have earned a whopping 48 Continuing Education Units (CEU's) and a beautiful presentation-grade certificate of completion forever testifying to your achievement.

EHS-3401-03 3.5" Disks

EHS-3401-05 5.25" Disks

# PERSONAL COMPUTER SERVICING, TROUBLESHOOTING AND NETWORKING



## The Jobs of Today and Tomorrow

Almost every corporation, governmental body, school system, and independent business is totally dependent on computers! Understanding how computers work, how to use them, and how to keep them working are essential skills in almost all jobs—from the secretary to the middle manager, from the shipping clerk to the UPS driver, from the electrical con-

tractor to the NASA scientist. It doesn't matter what vocation a student chooses, he or she will be using computers—probably even at home.

But there is a severe nation-wide shortage of trained computer technicians, field engineers, and support personnel who truly know how to maximize the performance of the PC—or to maintain, troubleshoot, and service them. Even more severe is the shortage of knowledgeable



people who can configure systems and set-up and maintain PC networks.

Today, every vocational student must understand computers. Upgrading, maintaining, and optimizing PCs, PC systems, and networks are all a part of computer literacy. That's why so many teachers and training directors have been telling us what kinds of computer courses they need. Well here they are! Heathkit's comprehensive comput-

er training package has everything you need to bring your students up-to-speed on computers.

The package is organized into the three most commonly requested sections—Servicing, Troubleshooting, and Networking. Most training applications will require teaching all three skills to provide students with the experience they need. Offering these courses in sections also allows instructors maximum flexibility so they can integrate the program into their existing classes, develop new highly overdue classes, and do it over whatever time-frame works for them.

At the heart of each course is Heathkit's PC Trainer. This trainer is built around a contemporary, powerful and extremely popular PC made by our sister company Zenith Data Systems. New unique features have been added, and it has been upgraded to make it more efficient and appropriate for effective teaching.

In the complete package, you get all of the training and equipment described on the next four pages. This way you get only the two PC Trainers you need, and save a bundle by purchasing the whole package at once.

### **Computer Servicing, Troubleshooting, and Networking Course EZS-400**

#### **PC Trainer Specifications:**

- Zenith Data Systems Computer (Energy Star™ compliant)
- CPU: 486SX-25MHz, upgradeable to DX-33, DX2-50/66, P24T
- System Memory 4 MB, expandable to 64 MB
- Local Bus Video with 1 MB DRAM to support up to 1024 x 768, 256 colors, noninterlaced, at VESA refresh rates, expandable to 2 MB DRAM
- COM1, LPT1—COM2 available for FAX/MODEM or second serial port
- PS/2-compatible, 101-key Keyboard
- 3.5", 1.44 MB Floppy Disk Drive
- 170 MB Hard Disk Drive
- Two-button, PS/2-Compatible Mouse
- Super VGA, .28 mm Dot Pitch Video Display Monitor (Energy Star™ Compliant, Multisync monitor available upon request)
- MS-DOS and Windows Software
- Send/Receive Fax MODEM, with Software and Cable
- Heathkit's Unique Fault Insertion and Removal System
- Software Backup Diskettes (with 40-disk storage box)
- Diagnostics Software and Evaluation Disks

# PERSONAL COMPUTER SERVICING, TROUBLESHOOTING AND NETWORKING...Cont'd



- Use jumpers, switches, and software to configure I/O addresses, interrupt request (IRQ) lines, and direct memory access (DMA) channels for various circuits in a PC.
- Install and configure a FAX/MODEM.
- Use the MODEM to receive a file from a bulletin board.
- Send and receive a FAX.
- Perform simple maintenance on a keyboard.
- Use troubleshooting techniques to evaluate, isolate, and identify several malfunctions down to the board or module level.

## Course Outline

- Disassembling the PC
- Inside the PC: Pieces of the Picture
- Avoiding Service: Preventive Maintenance
- Troubleshooting: What to do When Something Goes Wrong
- Installing New Boards (Without Creating New Problems)
- Repairs with Circuit Boards and Chips
- Semiconductor Memory
- Power Supplies and Power Protection
- Hard Disk Drive Overview and Terminology
- Hard Disk Drive Installation
- Hard Disk Preventive Maintenance
- Hard Disk Failure Recovery
- Floppy Disk Drives
- Printer Software
- Printers and Printer Interfaces
- Modems and Serial Interfaces
- Keyboards
- Displays and Display Adapters
- Buying New Systems and Upgrading Existing Systems
- Multimedia
- Appendixes:
  - Resource Guide
  - Short Overview on Reading Hexadecimal
  - Characteristics of Available Hard Disk Drives

The Heathkit PC Servicing course is a comprehensive program covering virtually every subject a student needs in order to **service, maintain, upgrade** and **optimize** any PC; from general circuit theory, to preventive maintenance, to module installation and system configuration, to module/board level troubleshooting and repair. Sixteen hands-on exercises illustrate all of the major topics presented in the best textbook available.

This hands-on course is structured so the student need not read every page of text. Rather, specific topics are identified to keep reading to a minimum while providing a thorough learning experience. Yet, everything the student would ever want to know about PCs is available for those who wish to go beyond the normal reading assignments.

The course assumes a working knowledge of MS-DOS and Windows. It also assumes a general knowledge of analog and digital electronics.

## Course Objectives

- Disassemble and reassemble a typical personal computer.
- Identify the major components found in a PC.
- Perform preventive maintenance procedures on the PC.
- Use visual and audio troubleshooting techniques to identify a malfunctioning component, module, or circuit board.
- Use diagnostic software to test and evaluate all circuits, ports, and disk drives in a PC.
- Remove and install a floppy disk drive and a hard disk drive, and properly prepare and configure the drives.
- Configure and install a second floppy disk drive.
- Backup and restore data on a hard disk to/from a floppy disk.
- Configure the system parameters in a PC and store the information in CMOS memory.
- Configure a video display for screen resolutions and colors.
- Explain dot pitch and resolution in a video display.
- Install additional system and video RAM and reconfigure the computer to accommodate that new memory.

## Lab Experiments

- Computer Disassembly
- Component Identification
- Computer Reassembly
- Using Diagnostic Software
- Configuring The Computer
- Troubleshooting Methods
- Computer Memory
- Hard Drive Removal and Installation
- Hard Drive Failure Recovery
- Floppy Drive Removal and Installation
- The FAX/MODEM
- Evaluating the Keyboard
- Video Characteristics and Memory
- Improving/Upgrading the Hardware and Software
- Troubleshooting a Malfunctioning PC
- Advanced Troubleshooting Techniques

## What You Get

- Heathkit PC Trainer (see page 41 for description)
- PC Servicing Textbook, Workbook, and Instructor's Guide
- PC Servicing Course Parts Pack:
  - 4 MB SIMM (System RAM), 128 KB Secondary Memory Cache
  - 1 MB Video DRAM (Two 512 KB x 16 ZIPs), 5.25", 1.2 MB Floppy Disk Drive, Serial and Parallel Loopback Connectors, Heathkit's Unique Fault Insertion Board, Parts Storage Case

**PC Servicing Course EZS-401**

# PERSONAL COMPUTER SERVICING, TROUBLESHOOTING, AND NETWORKING...Cont'd



## Troubleshooting PCs to the Component-Level

The PC Troubleshooting course is the logical extension to the PC Servicing course. It is a comprehensive program on how to troubleshoot a computer problem down to the specific defect.

Factory service centers seem to always be on the look-out for competent technicians. Because of the equipment and facilities needed to perform component-level maintenance, serious troubleshooting is often limited to these service centers. This course prepares students for this type of job.

Creating the need for in-the-field component-level repair is the recent influx of clones that have limited, if any, "factory" support— and situations where replacement modules and boards are not readily available. This course prepares students for this type of service also.

To ensure "real-world" learning, students study the operation of various computer circuits using the same technical manuals and schematics used by factory service technicians. Students then use that knowledge, diagnostics software, and common test equipment to troubleshoot malfunctions often found in typical PC circuits.

Malfunctions are created by the instructor using fault-insertion modules within the PC Trainer. These modules allow for over 20 different types of faults in various circuits. Although the faults are designed to function individually, they can be com-

bined to create a virtually unlimited number of complex problems for advanced students.

Because most components in PCs are surface-mounted, the student will not replace the suspected defective part. However, the student will identify the cause of the malfunction and explain to the instructor the steps taken to reach that conclusion.

The course assumes completion of the PC Servicing, Digital Techniques and Microprocessors courses, or equivalent knowledge.

## Course Objectives

- Use proper safety precautions to protect yourself, and your equipment.
- Explain several logical procedures for isolating a malfunction.
- Demonstrate the ability to locate and trace a signal on a schematic.
- Use a schematic to locate signal lines in the computer.
- Demonstrate the proper use of diagnostic software, an oscilloscope, and a logic probe.
- Use visual, audio, and electronic troubleshooting techniques to identify malfunctioning peripherals, boards, or components.
- Analyze and identify at least 20 different component-level malfunctions in a typical PC.
- Analyze, isolate, and identify the causes of simultaneous malfunctions.

## Course Outline

Computer Circuits Overview  
CPU and Support Circuits  
System Monitor and I/O  
System and Secondary Cache Memory  
Video  
Disk Drives and Their Control  
Investigative Techniques

## Lab Experiments

Through a series of 20 experiments, the student will become familiar with all aspects of troubleshooting the PC. Students will learn to apply logical step-by-step procedures to isolating specific troubles in the CPU, the ISA bus, hard drive, floppy drive, serial ports, parallel ports, etc. Students will learn to use diagnostics, service manuals, and schematic diagrams.

## What You Get

Heathkit PC Trainer (see page 41 for description)  
PC Troubleshooting Course Textbook  
PC Troubleshooting Course Workbook  
PC Troubleshooting Course Instructor's Guide  
PC Troubleshooting Course Parts Pack:  
Heathkit's Unique CPU Fault Insertion Board  
Heathkit's Unique ISA Bus Fault Insertion/Status Board  
Heathkit's Unique Video Fault Insertion Connector  
Heathkit's Unique Floppy Disk Drive Fault Insertion Connector  
Serial Loopback Connector  
Parallel Loopback Connector  
Computer Trainer Service Manual  
Computer Trainer Service Schematics  
Parts Storage Case

## PC Troubleshooting System EZS-402

# PERSONAL COMPUTER SERVICING, TROUBLESHOOTING, AND NETWORKING

...Continued



## Networking—The Most Needed, Yet Least Common Skill

Possibly the most needed skill, yet the least understood, is personal computer networking. It truly is the buzzword of the 90's. The use of computers for sharing or communicating information is growing faster than any other application for computers.

## Networking—A Critical Communications Tool in Almost All Businesses and Government

Unfortunately, most networks are originally installed by someone who works out the bugs and then leaves. Then, when one little connection goes out, or a board goes bad, or a new user is added, or new software is installed, or server disk space becomes scarce, it can literally render all users helpless. That's why it is so vital to have someone around who knows how to install, update, and maintain networks.

Until recently, networks were only in

larger organizations which could afford the position of Network Administrator. Even large companies have difficulty filling these positions. But today, hundreds of thousands of networks are installed each year in all sizes of organizations. There are simply not enough skilled people to handle the new needs created by all these networks. Networking skills simply have to become an integral part of every computer curriculum. This course is the way to add networking to your curriculum quickly, easily, and affordably.

## Networking—Teach it With Heathkit

In this course, students learn how to specify, install, and maintain local area networks. They learn the basics and protocols of data communications and communication architectures. They learn LAN cabling, network operating systems, and internetworking. And they also learn about managing and troubleshooting networks and internetworks.



## Course Objectives

- Install and configure FAX/Modem cards in computers and communicate between them.
- Install and configure typical networking interface cards
- Install and configure typical networking software including Novell NetWare Lite and Workgroups for Windows.
- Demonstrate the proper techniques for connecting networks using twisted pair and coaxial cables.
- Set-up and configure a peer-to-peer network.
- Set-up and configure a client-server network.
- Set-up and configure an Ethernet Network in both a bus and a star configuration.
- Plan, layout, and configure a network for a specific application.
- Explain the advantages, disadvantages, and characteristics of the most popular types of networks.

## Course Outline

- Networking Basics
- Introduction to Data Communications
- Communications Architectures
- Local Area Networking
- Communications and LAN Cabling
- Network Operating Systems (NOS)
- LAN Design, Planning, and Implementation
- Internetworking in a LAN Environment
- Internetworking in a WAN Environment
- Troubleshooting LANs: Tools, Techniques, and Strategies
- Interoperability Using Standards-Based Protocols
- Troubleshooting Enterprise Networks
- Internetwork Management

## Lab Exercises

### Peer-to-Peer

#### **Modems:**

Install and Configure Modems, Install and Configure Communications Software, Connect Telephone Lines, Operate Modems and Transfer Files, Operate Modems as fax machines and transfer messages, Troubleshooting Experiment

#### **Windows for Workgroups — MicroSoft:**

Install and Configure Cards, Install and Configure Communications Software, Connect Cables, Operate and Transfer Files, Troubleshooting Experiment

#### **NetWare Lite — Novell:**

Install and Configure Cards, Install and Configure Communications Software, Connect Cables, Operate and Transfer Files, Troubleshooting Experiment

### Client/Server

#### **NetWare Lite — Novell:**

Install and Configure Cards, Install and Configure Communications Software, Connect Cables, Operate and Transfer Files, Troubleshooting Experiment

## What You Get

- Two Heathkit PC Trainers (see page 41 for description)
- Computer Networking Textbook
- Activity Guide/Laboratory Workbook
- Two Windows for Workgroups software packages
- Two Novell NetWare Lite software packages
- Two modems
- One RJ11 telephone cord (w/ cross pinning)
- One ethernet hub (8 RJ45 in and 1 thincoax out)
- Two Ethernet interface cards
- Two RJ45 cables
- Two BNC terminators
- Two BNC F/M/F T-connectors
- One coax cable
- Heathkit's Unique Trouble Insertion Module
- Two Storage Boxes

## PC Networking Course EZS-403

# MASTER COURSE IN PERSONAL COMPUTERS



At Last! A Fast, Easy Way For Individual Learning Students To Become the Computer Experts They Always Wanted To Be

## Over 100 Million Personal Computers (PCs) Are In Use...

and the number is increasing every day. Many opportunities arise from the fact that PCs do not last forever. Computers are machines, and, just like automobiles, require care and maintenance. Also, the applications and software we use are constantly changing, requiring faster processors, more memory, and larger disk drives. Like automobiles, you can choose to fork out big bucks every few years for a newer model PC, or you can maintain, repair, and upgrade to keep your computer running strong. The Master Course In Personal Computers can teach you how to keep all of the PCs in your office, business or home, fresh, useful, and optimized without having to replace them every few years.

Think about how dependent businesses and individuals are using computers and how disastrous the consequences are when a computer breaks. The older they are and the more they are used, the more likely they are to fail.

Consider the hard disk as just one example. Its outer surface travels over 50 miles/hour. And yet, a fraction of a hair away, a delicate read-write head

twitches back and forth across the disk. The microscopic space between these two fast moving surfaces is dwarfed by the tiniest speck of dust. Eventually, the inevitable happens and the head grazes the speeding disk. The result is a disastrous "disk crash"... a true calamity for the user. And yet, this is the ultimate fate of nearly every hard disk. If it has not happened to your PC yet, one day it will. How do you put-off that day for as long as possible? And when it finally happens, how do you recover from it? We'll show you how.

Ironically, most PC failures are not hardware malfunctions at all. They are "soft" failures that can be corrected from the keyboard by anyone knowledgeable enough to recognize the problem and fix it. The Master Course In Personal Computers equips you to deal with many other dilemmas of the PC revolution. How do you keep your PCs running as well as possible, for as long as possible? Then, once they fail, how do you recover from the failure quickly and gracefully? This kind of specialized knowledge is in big demand. It can increase your responsibilities and your pay check in any environment where PCs are used.

## Here are some of the things you will learn on your way to becoming the resident PC expert:

- Disassemble, identify the major components, and reassemble a typical PC.
- Perform preventive maintenance procedures to a PC
- Use visual and audible troubleshooting techniques to identify a malfunctioning component, module, or circuit board in a PC.
- Use diagnostic software to test and evaluate all of the circuits, ports, and disk drives in a PC.
- Remove and install a floppy and a hard disk drive and properly prepare and configure the drives.
- Backup and restore data on a hard disk drive.
- Configure the system parameters in a PC and store the information in CMOS memory.
- Configure a video display for different screen resolutions and displayed colors.
- Explain dot pitch and resolution in a video display.
- Install and configure the computer memory.
- Use jumpers, switches, and software to configure I/O addresses, interrupt request (IRQ) lines, and direct memory access (DMA) channels for various circuits.
- Install, configure, and use a send-and-receive FAX/MODEM.

## Our course provides everything you need... including the computer!

This is not some no-name clone that will leave you searching the world for parts and service. This is a fully loaded Zenith Data Systems Energy Star™ compliant computer with:

- 486SX-25MHz, upgradeable to DX-33, DX2-50/66, or P24T; with 170 MB Hard Drive, 3.5", 1.44 MB Floppy Drive, 4 MB of system memory, expandable to 64 MB
- Local Bus Video with 1 MB DRAM to support up to 1024 x 768, 256 colors, noninterlaced, at VESA refresh rates, and it's expandable to 2 MB DRAM
- Serial port, parallel port, an internal second serial port connector for a FAX/MODEM or a second serial port
- PS/2-compatible, 101-key Keyboard, and Mouse
- Super VGA, .28 mm Dot Pitch, Multisync Video Display Monitor
- MS-DOS and Windows pre-installed

## A True Multi-Media Learning Experience

Using a combination of Computer-Aided Instruction (CAI), printed material, hands-on exercises, and diagnostic software, there is no other course of comparable value or effectiveness anywhere. Throughout the course you will learn much more than just replacing computer boards.

In fact, you will accumulate the knowledge-equivalent of taking many of our comprehensive Individual Learning Programs separately.

You will end up covering our intensive 50-hour core electronics series courses in our famous computer-aided instruction format. With the computer as an interactive teacher, you will enthusiastically breeze your way through our easy-to-follow core electronics courses:

- **DC Electronics**
- **AC Electronics**
- **Semiconductor Devices**
- **Electronic Circuits**
- **Digital Techniques**

These courses will equip you with a foundation of knowledge so you understand how and why different computer subsystems operate.

To learn everything you need to perform preventative maintenance, troubleshoot, repair, and upgrade your PC to keep it running and at peak efficiency, you will study the theory and conduct the many hands-on exercises in our new Individual Learning Program:

- **PC Upgrading and Maintenance**

## The most extensive and complete program around—you also get:

- One 4 MB SIMM to increase system memory to 8 MB
- One 128 KB secondary memory cache
- Two 512 KB x 16 ZIPs to increase video memory to 2 MB
- Send-and-receive FAX/MODEM, with software
- Software backup diskettes
- A 40-disk capacity, 3.5" diskette storage box
- ZDS diagnostics software and evaluation diskette
- An 11-piece PC servicing toolkit
- Six Individual Course Examinations
- Six Individual Course Diplomas
- Nine CEUs of credit
- The Master Examination
- A Presentation-Grade Diploma (when the Master Examination is successfully completed)

As a prerequisite to completing this comprehensive program, you should have a working knowledge of MS-DOS and Windows.

Make an investment in your future. Order your Master Course in Personal Computers today.

.....  
**Master Course in Personal Computers**

**EHS-6002**

# VCR SERVICING



## VCRs – How they work – How to fix them

The VCR is a remarkable combination of mechanics and electronics. If you look inside a VCR, you find a vast array of pulleys, belts, motors and microelectronics. The VCR is not only intimidating, it also has a notorious reputation of failing. Indeed virtually every heavily-used VCR will require attention of some kind within a year or so... usually just after the warranty expires. Many repair shops charge a bundle for VCR servicing. The irony is that most malfunctions are mechanical breakdowns or just plain old dirt and dust accumulations that are incredibly easy to learn to fix.

Now students can learn everything necessary to keep VCRs running flawlessly for years. This course is a prime example of a "school-to-work" type program.

And you may be surprised at how easy it is to learn. For many problems, you don't have to be an electronics wizard or an expert at micro-mechanics. Surprisingly, many problems can be fixed quickly and simply once you know the tricks. Often the problem may be something as simple as dirty video heads, jammed tapes, worn rubber belts or rollers, dirty contacts, etc. These are things that can be fixed quickly using the tools we provide.

But unlike other VCR repair courses, Heathkit's course goes far beyond the routine. Students delve into, test, and troubleshoot the sophisticated electronic circuitry of one of the most technically advanced VCRs ever built. We not only teach these secrets, but we also show preventative maintenance techniques that will greatly extend the life of any VCR.

# VCR servicing course features one of the finest VCR's ever

We supply everything you need... including a top-notch VCR.

In order to absolutely insure that your initial VCR encounters are successful, we leave nothing to chance... not even the VCR. Our step-by-step experiments and demonstrations lead you through the intimidating mechanics and electronics that make up the modern VCR. And what a unit we have chosen to serve as your laboratory! This fully-loaded RCA VHS unit is one of the most technically advanced and feature-packed VCRs ever made!

## Characteristics of the VCR Included with Course:

- Master Touch Universal Remote Control (controls 30 brands of TVs)
- Built-in VCR Plus Auto-Programming System
- Double Azimuth 4-Head Video System
- 181-Channel Cable Compatible Tuner
- Simplified On-Screen Programming
- On-Screen VCR Setup Display
- VHS Hi-Fi Stereo Recording/Playback
- MTS Broadcast Stereo Reception
- 8-Event, 1 Year Programmable Timer
- Special Effects - Search, Still, Single-Frame, Advance and Variable Slow Motion
- Pro-ject Plus
- Dual VCR Control with AutoEdit
- Level Meter Display
- Timer Backup
- Automatic Head Cleaner
- High-Speed Rewind

## This Complete VCR Servicing Course Includes:

- Troubleshooting and Repairing VCR text (700 pgs)
- Experiment Manual/ Activity Guide
- VHS Test Pattern Tape
- High Reliability and Surface Mount Soldering Video
- VCR Tape Simulator
- Troubleshooting Aid
- 10-Piece Tool kit
- VCR Head Cleaner and other VCR Cleaning Supplies
- VCR Lubricants & Rubber Revitalizer
- A Collection of Common Replacement Parts
- RCA Service Manuals

## Lab Experiments:

- Unpacking, Hookup, & Testing
- Looking Inside the VCR
- The Tape Cartridge
- High Reliability and Surface Mount Soldering
- VCR Cassette Simulator
- Safety
- Head Cleaning and General Maintenance
- Replacing Video or Hi-Fi Audio Heads
- Power Supply Problems
- Linear Audio and Control Heads
- Hi-Fi Stereo
- Loading Motor
- Signal Checking at the Microprocessor

## What You Need:

- TV
- Multimeter
- Oscilloscope
- 9-volt battery

## Suggested Course Pre-requisites:

- DC through Digital Techniques or equivalent

## Course Outline

- The VCR Environment
- Introduction to Videocassette Recorders
- How VCRs Work
- Tools and Supplies for VCR Maintenance
- Introduction and Basic Troubleshooting
- Routine Preventive Maintenance
- General Cleaning and Preventive Maintenance
- VCR First Aid
- Troubleshooting and Repairing Non-VCR Problems
- Troubleshooting
- Troubleshooting VCR Malfunctions
- Specific Troubleshooting & Repair
- Magnetic Recording Theory
- VCR Operating Theory
- Advanced Troubleshooting
- Repairing Camcorders

# CAMCORDER SERVICING



## The Hottest New Consumer Electronics Product

image transducers, plus how electronic signals are recorded onto magnetic media and played back again. Beyond maintenance and repair, this course also embodies students with the knowledge to get the most out of their own camcorders.

Students learn how to clean, service and repair camcorders. They delve into, test, and troubleshoot the sophisticated electronic circuitry of one of the most technically advanced camcorders ever

built. We teach these secrets and show preventative maintenance techniques that will greatly extend the life of any camcorder.

### Camcorders—Marvels of Electronics Technology

Because millions of people each year buy camcorders, servicing camcorders is already one of the fastest growing career fields. That's why no serious electronics student should be without this course.

Camcorders are marvels of technology that have progressed to the point of near-perfection. Ten years ago you would have spent over \$10,000 to get video-recording equipment this exceptional. With micro-engineering and surface-mount technology, camcorders jam-pack an amazing combination of mechanics, photo-optics, and electronics into a box that fits in your hand.

### Sophisticated Yet Failure-Prone

Like VCRs, camcorders are notorious for failing. The dirt, dust, and lint alone from using it around the home, on vacations, at parties, or merely taking it in and out of its case is enough to degenerate its performance.

Since camcorders are gaining in popularity and represent a big investment, the demand for qualified camcorder service technicians outpaces supply. Yet, you may be surprised how easy it is to learn to service them. Many problems can be fixed quickly and simply once you know the tricks and have the tools. The problem may just be dirty video heads, jammed tapes, worn rubber belts or rollers, dirty contacts, etc.

Unlike others, Heathkit's course goes far beyond the routine. Students learn the theories of light, optics, color, electronic shutters,

Course ET-4020

### Characteristics of The Camcorder

- 1 lux low-light recording
- 12x power zoom
- 2 line/2 page titler
- Accessory hot shoe
- Quick response infrared autofocus
- Video/audio fade control
- PROedit™ dubbing feature for smooth transitions at point of dubbing

### What You Get:

- RCA VHS-HQ Camcorder
- Camcorder textbook
- RCA Service Manual
- VCR Cassette Simulator
- Experiment Manual/Activity Guide
- VHS Heathkit Test Pattern Tape
- VHS blank tape
- High Reliability and Surface Mount Soldering Video
- Cleaning Supplies: Head cleaner, Lintless swabs, Chamois wands, Grease, Rubber revitalizer
- Solder braid
- Final Exam package
- Tool pack

### Lab Experiments:

- Unpacking, Hook-up, Testing
- Mechanism Servicing Video
- Looking Inside
- Infrared Light Detection
- Safety
- The Tape Cassette
- Using the Cassette Simulator
- High Reliability and Surface-Mount Soldering Video
- Viewfinder and Camera Block Disassembly
- VCR Removal
- Head Cleaning & General Maintenance
- Replacing Video or Hi-Fi Audio Heads
- Loading Motor
- Linear Audio and Control Heads
- Signal Checking at Test Points

### What You Need:

- TV
- Multimeter
- Oscilloscope
- 9-volt battery

### Suggested Course Pre-requisites:

- DC through Digital Techniques or equivalent

### Course Outline

- Camcorder and Video Cassette Formats
- Audio Circuits
- Tips and Techniques
- Mechanical Tape Operations
- The Camera Section
- Remove and Replace
- Video Circuits
- Mechanical Adjustments
- System Control
- Electrical Adjustments
- Trouble Detection and Servo Circuits
- Troubleshooting
- Motor Circuits
- Power Supplies

For Pricing, See Center of Catalog

# TV SERVICING COURSES



## Comprehensive Course Provides Foundation for General Electronics Servicing

Today's color TV sets are true marvels of electronics design and engineering. They contain a wider variety of electronic circuitry and assembly techniques than virtually any other electronic device in their price range. Fact is, the TV set we have selected is equipped to function as a practical, affordable real-life electronics laboratory.

That's the basic premise behind Heathkit's TV Servicing Course.

With just a few simple test instruments, our comprehensive textbook, experiment manual and hands-on experiments, plus a brand new RCA 20" stereo color TV set (included with the course), students explore and learn about assembly techniques used in today's highly complex electronics equipment and how to service virtually all of the important circuit designs.

Today's typical TV sets utilize both analog and digital circuitry, as well as surface-mount technology and conventional assembly techniques. They employ a wide range of semiconductor devices, including linear and digital ICs, bipolar and field-effect transistors, diodes and varactors. They also use a variety of magnetic devices including flyback transformers, deflection coils, degaussing coils, and speakers. They even use a vacuum tube!

TVs work with frequencies from DC to several hundred MHz and most of the ranges in between, and with voltages ranging from a few microvolts to 30 kilovolts.

The bottom line is, once students understand how modern TV sets work and have learned how to troubleshoot, align, maintain and repair them, they will have mastered a body of knowledge that goes far beyond TV repair and maintenance — into the wider universe of electronics servicing in general. And that's what our course is designed to do!

### What you get:

- 20-inch RCA stereo color television with remote control
- Hardbound Television and Video Systems textbook
- Experiment Manual/Activity Guide - leads you step-by-step through your course with 13 hands-on lab sessions. You will learn the operation, alignment, troubleshooting and repair techniques first hand.
- Isolation transformer
- VHS Test Pattern Tape - turns your VCR into a Test Pattern Generator to produce several different types of test patterns.
- RCA Service Manuals - used by factory authorized service technicians for troubleshooting and repairing. You will learn how to use them.
- RCA Beam Bender - used to converge the three electron beams in the picture tube so that each strikes only the correct color phosphor.
- Alignment tools
- Chapter quizzes
- Comprehensive final examination
- Heathkit grading service
- Heathkit Educational Systems Certificate of Completion

### Lab Experiments:

- Safety (Cabinet removal, high voltage areas)
- Low voltage power supplies
- High voltage power supplies
- Vertical deflection circuits
- Horizontal deflection circuits
- Vertical sync circuits
- Convergence
- Special circuits
- Tuners
- AGC
- Horizontal retrace
- Picture tube removal and replacement
- Audio system

### Characteristics of the TV Set:

- A 20-inch RCA stereo color television
- Cable ready
- 68 off-the-air channels
- 122 cable channels
- On-screen programming
- Auto programming
- Sleep timer
- On-screen clock
- Commercial skip feature
- MTS Stereo sound
- RF, Composite, and S-video inputs
- Remote control

### What you need:

- Digital Multimeter, Oscilloscope
- VHS video cassette recorder (VCR)

### Course Requirements:

- Core Electronics Series courses
- One of our Digital Techniques courses
- Our Microprocessor courses, or equivalent knowledge

### Course Outline

- |                                     |                                     |
|-------------------------------------|-------------------------------------|
| • The Television System             | • Video IF, Detector, and AGC       |
| • Television Receivers              | • Video Amplifiers                  |
| • Electronic Components             | • Chroma Signal Processing          |
| • Test Equipment and Servicing Aids | • Chroma Switching and Color Sync   |
| • Troubleshooting Techniques        | • Working with CRTs                 |
| • Power Supplies                    | • Television Sound                  |
| • Vertical Deflection Circuits      | • Digital TV, Monitors, Enhancement |
| • Horizontal Sweep Generators       | • Video Cassette Recorders          |
| • Sync Stages                       | • VCR Troubleshooting and Repair    |
| • Drivers, Output, and High Voltage | • Projection Television             |
| • Tuners and Remote Controls        | • Shutdown/Startup Systems          |

# COMMUNICATIONS COURSES

## Electronic Communications

This course teaches amplitude, frequency, and phase modulation. It explores the technologies of transmitters and antennas and explains how all these components can be linked to form communications systems.

Students will do seven experiments including building AM and FM transmitters and receivers, a time division multiplex transmitter, a data communications modem and more.

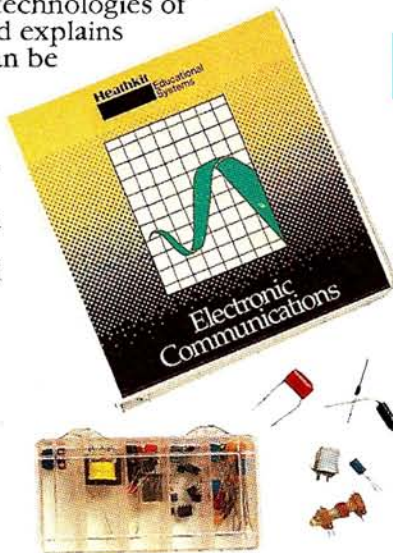

### A Sampling of Course Objectives

- Explain the characteristics, advantages and disadvantages of amplitude frequency and pulse modulation.
- Analyze the composition of complex waveforms.
- Describe operation of AM/FM transmitters and receivers.
- Construct basic communications circuits.
- Explain differences between frequency and phase modulation.
- Discuss frequency and time division multiplexing as methods to increase communications channel capacity.
- State the characteristics and uses of transmission lines.
- Explain electromagnetic radiation and propagation, and list the various types of propagation.
- Discuss the basic types of antennas, including dipoles, verticals and directional arrays.
- Discuss basic communications systems, including TV and FM stereo broadcasting and data communications.

## Data Communications and Networks

This course covers terminal devices, modulation, multiplexing and transmission media, including telephone and specialized data networks.

Digital and analog signaling techniques, phone circuits, networking and data transmission are discussed in full detail.

Course material is reinforced by 11 laboratory experiments.

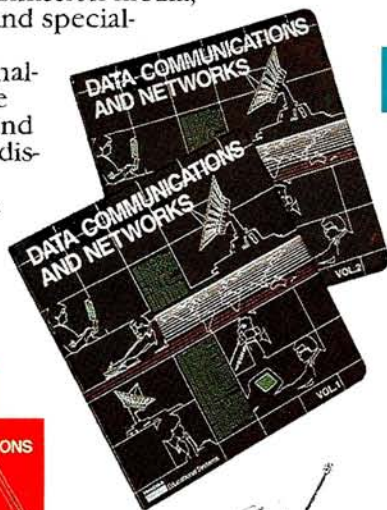

### A Sampling of Course Objectives

- State the characteristics of a communication channel for both analog and digital transmissions.
- Explain signaling techniques used with DC and AC signals.
- Identify the different digital communication codes in common usage and list their typical uses, advantages and disadvantages.
- Compare typical modulation systems used with DC/AC signals.
- Explain how Pulse Code Modulation works and state its strengths and weaknesses.
- Describe the process of multiplexing signals.
- Compare the types of transmission media used in the world's communications systems.
- Describe the organization and operation of the telephone system and state its use in data communication.
- List the varieties of data-transmission networks and compare their operation and suitability for data communication.
- List the various types of transmission impairments that affect data transmissions and state how their effects can be corrected.
- Analyze computer systems security issues when interconnected by data communications and how to avoid unauthorized access.
- List the major data networks operating today and how they are used by the average consumer.



SUBJECT	TRAINER	PARTS PACK	TEXT	WORKBOOK/ LAB MANUAL	INST GUIDE/ ADMIN GUIDE	IND. LEARNING PROGRAM
ELECTRONIC COMMUNICATIONS (Instructor-Led) (Individualized Learning)	ETW-3600 ETW-3600	EB-6106-30	EB-6106	EB-6106-40	EB-6106-50	EE-3106-A
DATA COMMUNICATIONS and NETWORKS (Instructor-Led) (Individualized Learning)	ETW-1000 ETW-1000	EB-8090-30	EB-8090	EB-8090-40	EB-8090-50	EE-8090

For Pricing, See Center of Catalog

# LASER TECHNOLOGY

Lasers, now used routinely to perform delicate surgery, are also used to transmit information over long distances, melt metals, cut materials and inscribe information. New applications are being discovered daily. Students study laser design, types and compo-

nents, and learn the effects and potential hazards of laser light, plus the effects of infrared radiation.

Students will transmit and reproduce sound over a laser beam and work with a laser to measure light and transmit data.

## LASER TECHNOLOGY COURSE

EB-610 (Instructor-Led)

EE-110 (Individual Learning, 3 CEUs)

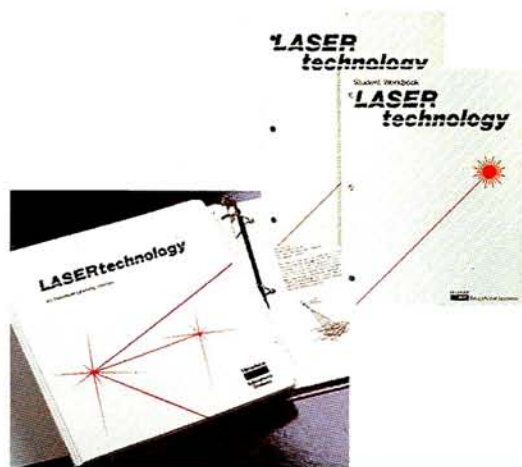

## Course Objectives

- Defines basic optical terms and concepts related to lasers.
- Compares laser light with "ordinary" light.
- Lists the essential components of lasers.
- Explains the function of each laser component.
- Shows how laser light is generated and how it can be modulated.
- Identifies various types of common lasers by their output.
- Matches a type of laser to a given application.
- Recognizes safety hazards for different classifications of lasers.
- Calculates power density at the focal point of a lens if laser and optical parameters are given.
- Before taking this course, students should have taken the basic electronics courses through Electronic Circuits and have a basic knowledge of algebra.

## LASER TRAINING SYSTEM EWS-4200-A & ETS-4200 (KIT)

- This commercial quality training system includes a low-power Class II helium-neon laser — and a laser receiver. Together this powerful system gives students first-hand experience with an actual laser and accurate laser measuring equipment.
- Transmitter features a helium neon gas laser that generates an intense, easy-to-see red light, and a pilot light.
- Features a mechanical beam shutter for extra safety, a tripod mount and signal input jacks to use with an external modulating signal source.
- The transmitter is equipped with modulation circuitry — unique for a laser in this price range — to demonstrate the latest communications technology.
- The receiver comes with a built-in detector and a built-in relative power meter to measure the beam's intensity, audio amplifier and speaker.
- UL Listed

**Specifications**  
 Output Power: 0.4-0.9 mW  
 Wavelength: 632.8 nm, visible red  
 Beam Diameter: at 1/ePTS 0.49 mm  
 Beam Divergence: 1.64 mrad  
 Polarization: random  
 DHHS\* Class: II  
 Modulation Bandwidth: 300 Hz-40 kHz +/- 3 dB  
 Auxiliary Input: 1 volt peak-to-peak  
 Microphone Input: 100 mV peak-to-peak, designed for crystal microphone of 50k impedance  
 Power Requirements: 120 VAC, 60 Hz @ 15 watts  
 Dimensions: 3" H x 4" W x 14" D [8.3 x 9.5 x 35.2 cm]  
 Weight: 3 lbs (1.2 kg)

**CAUTION**

Laser Light  
Do not stare into beam

Ordering Numbers	SUBJECT	TRAINER	PARTS PACK	TEXT	WORKBOOK/ LAB MANUAL	INST GUIDE/ ADMIN GUIDE	IND.LEARNING PROGRAM
	LASER TECHNOLOGY (Instructor-Led) (Individualized Learning)	EWS-4200-A EWS-4200-A	EB-610-30	EB-610	EB-610-40	EB-610-50	EE-110



# ELECTRO-OPTICS

The EB-611 Electro-Optics course covers basic optical principles, light sources, displays and light-reactive components. The course also gives an overview of fiber optics and describes how electro-optic devices

are linked to form communications circuits.

Before taking this course, students should have taken DC Electronics, AC Electronics, and Digital Techniques.

## ELECTRO-OPTICS COURSE EB-611 (Instructor-Led)

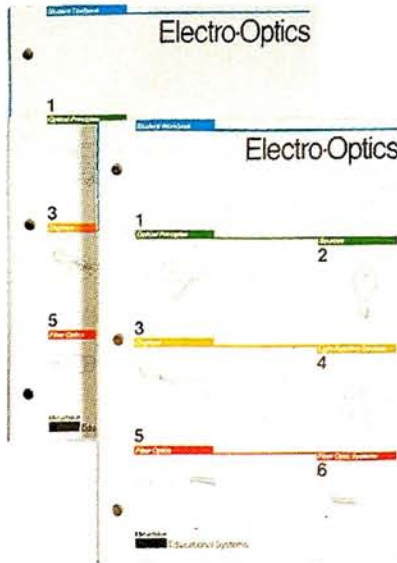

## Course Objectives

- Correctly bias an LED indicator circuit.
- Describe the characteristics and advantages of coherent light.
- Explain why energy pumping is necessary for laser operation.
- Describe two methods of obtaining population inversion.

- Compare the operational characteristics of interrupter and reflector modules.
- Explain the photoelectric effect.
- List the criteria for judging photodetector performance.
- Recognize the major photodetector types and describe their operation.
- Describe the parts of a typical photodetector receiver circuit.

### Display

- Describe the two major classifications of displays.
- List the four main types of character displays.
- Describe the major advantages and disadvantages of each type in various applications.
- Explain the various electronic circuits necessary to drive character displays.
- Describe the capabilities of graphic display systems.
- List the parts of a cathode ray tube and explain their functions.
- Describe the capabilities of graphic display systems.
- Explain the three major CRT scanning techniques.
- Describe the operation of the "shadow mask" color CRT.

### Fiber Optics

- Describe the two methods of light propagation within optical fibers.
- Calculate the critical angle of propagation and numerical aperture of a step-index fiber, given  $N$ .
- Describe the three types of optical fiber construction.
- Compare the advantages and disadvantages of each type of fiber for given applications.
- List and compare the characteristics of plastic and glass fibers.
- List five general areas where energy or information can be lost in a fiber optic data link.
- Name five factors that determine the amount of light coupled from a source to a fiber.
- Describe the differences between a general purpose LED and a fiber optic LED.
- Describe six factors that contribute to attenuation within a fiber-to-fiber connector.
- Compute the dB loss due to reflection when coupling light into or out of a fiber, given the refractive indices of the core material and the coupling medium.
- Explain the relationship between SNR and bit error rate.

## Course Objectives

### Optical Principles

- Describe the characteristics of light.
- Determine the wavelength of any given light frequency.
- Determine the approximate color of any visible light wavelength.
- Explain the difference between the radiometric and photometric systems for measuring light.
- Describe the following interaction of light and matter: Reflection, Refraction, Absorption, Diffusion
- Predict the reaction of light rays to the following optical components: Mirrors, Lenses, Prisms
- Define the following units of measurement used in optics: Energy, Flux, Incidence, Exitance, Intensity, Sterance

### Sources

- Describe the generation of light at the atomic level.
- Explain the operation and characteristics of incandescent lamps, gas discharge lamps, light emitting diodes, laser devices.

### Light-Reactive Devices

- Describe the four major categories of light-reactive devices.
- State the major physical and electrical differences between photoconductive and photovoltaic cells.
- Determine the proper circuit load to obtain maximum power from a photovoltaic cell.
- Describe how solar cells can be connected to form solar batteries and arrays.
- Correctly bias photodiodes for use as light detectors.
- Compare the characteristics of PN and PIN photodiodes.
- Compare the relative merits of photodiodes and phototransistors.
- Describe the operation and characteristics of a PHOTOFET device.
- List the similarities and differences between SCRs and LASCRs.
- Describe the advantages and limitations of the photomultiplier tube.
- Describe the construction and applications of integrated interrupter modules.

### Fiber Optic Systems

- Classify fiber optic communication systems using three performance parameters.
- Describe eight different types of fiber optic communication systems.
- Compare the performance of different systems using three performance factors.
- Describe the various kinds of fiber optic connectors and splices.
- Compare the relative merits of the different connectors and splices.
- Prepare a system budget for power loss and rise time.

SUBJECT	TRAINER	PARTS PACK	TEXT	WORKBOOK/ LAB MANUAL	INST GUIDE/ ADMIN GUIDE
ELECTRO-OPTICS	ETW-3700	EB-611-30	EB-611	EB-611-40	EB-611-50

# OSCILLOSCOPES

Heath designed these deluxe 25, 40, and our new 60 MHz dual-trace oscilloscopes to outperform "look-alike" products

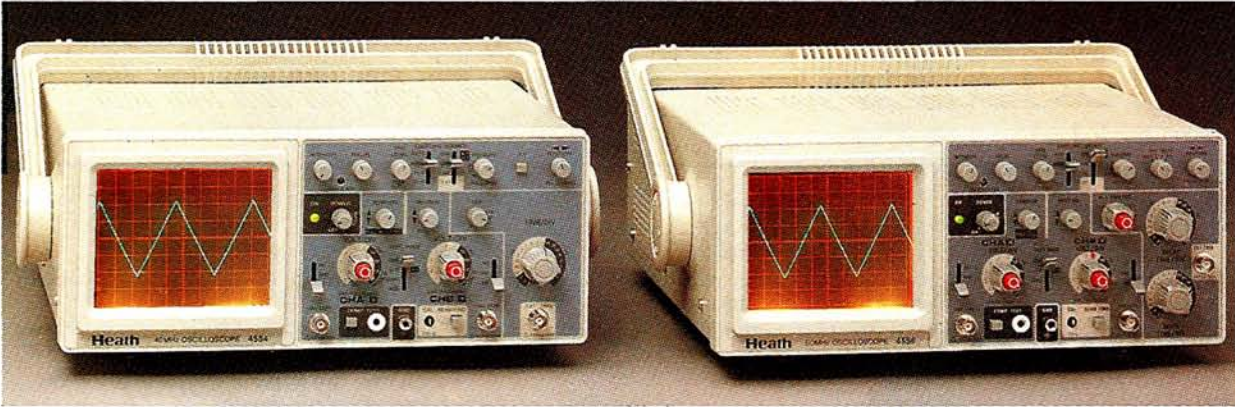

## Deluxe Oscilloscopes

You can't always judge an oscilloscope by its front panel. You may have seen others that at first glance look similar to these Heath instruments, but don't be fooled. After checking out the competition, you'll agree that Heath scopes can't be beaten for value. These ergonomically designed dual-trace oscilloscopes give accurate measurements and include a host of time-saving features. Simply put, you just can't buy a better instrument for the money.

The 25 MHz SO-4552 is ideal for Heathkit courses, while the 40 MHz SO-4554 and 60 MHz SO-4556 are perfect for engineering applications and servicing today's high speed equipment. Each scope gives you, 1 millivolt-per-division sensitivity that lets you measure signals too small for 5 millivolt instruments. Each has a 10X horizontal magnifier that lets you expand signals twice as much as ordinary 5X magnifiers. TV horizontal and vertical triggers let you look at TV waveforms that would confuse less sophisticated trigger circuits. And the trigger holdoff function lets you achieve stable triggering on repetitive pulse trains. You can use the A+B mode with B inverted to make differential measurements without ground reference and the XY mode for Lissajou patterns.

## Features that make these scopes a pleasure to use

These instruments operate on 90-264 VAC, 50/60 Hz, and have been extensively tested to meet UL requirements. Each has a built-in component tester for in-and-out-of-circuit current vs. voltage testing. A beam finder saves you time by forcing off-screen traces back on screen. The variable graticule illumination makes for easy observation of signals under low light conditions and is essential if you expect to record your measurements with an oscilloscope camera. The handle adjusts so you can tilt the scope at a convenient angle. When not in use, the handle can be stowed. A built-in calibrator lets you check instrument accuracy and adjust the compensation of your probes. The SO-4554 and SO-4556 feature a 9KV accelerating potential for bright traces at higher sweep speeds.

### Specifications:

Vertical: Ranges: 5 mV to 5 V/DIV; in 1-2-5 with variable. Magnification: 5X. Accuracy (1 kHz):  $\pm 3\%$ ,  $\pm 5\%$  for X5 gain. SO-4552 Bandwidth: DC to 25 MHz, DC to 10 MHz on 1 mV/DIV. Rise Time: 18 ns. SO-4554: Bandwidth: DC to 40 MHz, DC to 15 MHz on 1 mV/DIV. Rise Time: 9 ns. SO-4556 Bandwidth: DC to 60 MHz on 1 mV/DIV. Rise Time: 5.8 ns. Overshoot: 5%. Maximum Input: 400 V. Operating Modes: CHA, CHB, DUAL (ALT or CHOP), and ADD. Horizontal: Sweep: .2s to .1 $\mu$ s/DIV; in 1-2-5 with variable. Delay Sweep (SO-4556 only) .2s to 1 $\mu$ s/DIV; in 1-2-5 with variable. Magnification: 10X. Accuracy:  $\pm 3\%$  for X1,  $\pm 6\%$  for 10X. X-Y: Sensitivity: Same as CHA and CHB. Frequency Response: DC to 1 MHz. Trigger: Source: CHA, CHB, LINE and EXT. Coupling: AUTO, NORM, TV-V, TV-H. Slope: "+"; pull Trig Level for "-". External Input: Impedance: 1 M $\Omega$ , 30 pF. Maximum Input 300 V. General: Power: 90-264 VAC, 50/60 Hz, 40W. Dimensions: 5.25" H x 12.75" W x 17.25" D.

- SO-4552 25 MHz Oscilloscope
- SO-4554 40 MHz Oscilloscope
- SO-4556 60 MHz Oscilloscope



## 150 MHz Probe

Enjoy premium performance without the premium price. This feature-packed P-150 probe with switchable 10:1 and 1:1 ratios delivers everything you want at an economical price. Advanced design delivers quick pulse response and faster rise time — less than 1.5 ns.

P-150

PS-150 Two probe set

# SOLDERING, METERS AND TOOLS

## Heathkit soldering course is great for industrial training too

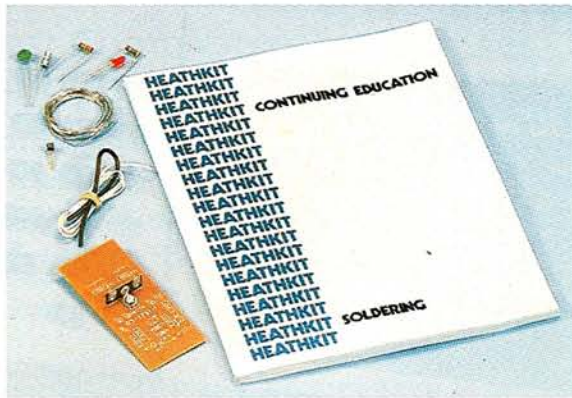

Soldering is a critical skill when working with electronic equipment. One faulty connection can cause major equipment failure. Learn everything you need to know about making the right connections in this clear, concise course. You'll learn the techniques of soldering, proper iron size and temperature. You'll learn how to make strong connections, how to avoid solder bridges - and even how to desolder.

What you get:

- Comprehensive illustrated text
- 6 hands-on experiments
- Complete parts package

**EI-3133**

### Pocket-sized DMM measures up to 10MHz

This portable DMM is virtually a full-test bench packed into a single, hand-held unit! Unit gives 0.5% basic accuracy and a long list of features: Frequency measurements to 20 MHz; resistance up to 2000 Megohms; capacitance, transistor hFE and LED tests. Unit also serves as logic probe up to 20 MHz. Test leads included. **SM-2372**

Specifications: VOLTS DC: Ranges (5) 200 mV-1000V. Accuracy:  $\pm(0.5\% \text{ rdg} + 1 \text{ digit})$ . VOLTS AC: Accuracy:  $\pm(1.0\% \text{ rdg} + 4 \text{ digits})$ . AMPS DC: Ranges: (5) 200 $\mu$ A to 10A. Accuracy:  $\pm(1.0\% \text{ rdg} + 1 \text{ digit})$ . AMPS AC: Accuracy:  $\pm(1.2\% \text{ rdg} + 4 \text{ digits})$ . RESISTANCE: Ranges (7) 200 $\Omega$ -2000 M $\Omega$ . Accuracy:  $\pm(8\% + 2 \text{ dgt})$ . CAPACITANCE: Ranges (5) 2000 pf-20  $\mu$ F. Accuracy:  $\pm(3\% \text{ rdg} + 10 \text{ digits})$ . FREQUENCY: Ranges (5): 2 kHz-20 MHz. Accuracy:  $\pm(1.0\% \text{ rdg} + 1 \text{ digit})$ . GENERAL: Power: 9 volt alkaline battery included. Battery Life: 20-100 hours.

### Economical full-function meter

Compact unit is perfect for the lab, workbench or field. Its 3 1/2 digit display gives readings to 999 and automatic polarity indications. Functions include resistance, capacitance, transistor DC gain and diode test, and audible continuity. Current ranges, except for 10A range, are fuse protected. Test leads included. **SM-2311**

Specifications: VOLTS DC: Ranges (5) 200 mV-1000V. Accuracy:  $\pm(0.5\% \text{ rdg} + 1 \text{ count})$ . VOLTS AC: Ranges: (5) 200 mV-750V. Accuracy:  $\pm(1.0\% \text{ rdg} + 4 \text{ counts})$ . AMPS DC/AC: Ranges: (5) 200 $\mu$ A-10A AMPS DC. Accuracy:  $\pm(1.0\% \text{ rdg} + 1 \text{ count})$ . AMPS AC: Accuracy:  $\pm(1.0\% \text{ rdg} + 1 \text{ count})$ . CAPACITANCE: Ranges: (5) 2000 pf-20  $\mu$ F. Accuracy:  $\pm(3\% + 10 \text{ counts})$ . RESISTANCE: Ranges (6) 200-20 M. Accuracy:  $\pm(8\% \text{ rdg} + 1 \text{ count})$ . GENERAL: Power: 9 volt battery included. Battery Life: 400 hours. Input impedance: 10 M $\Omega$

### Autorangeing DMM is real tough customer

This DMM is shock- and water-resistant with industrial grade, safety yellow case. It features 3 1/2 large, easy-to-read digit numerals and a 40-segment analog bar graph. Display also shows polarity, overrange, display hold and measurement unit annunciators. DMM measures AC and DC voltages, current, resistance, continuity and diode test. Current ranges are fuse protected. Safety enhanced test probes included. **SM-2380**

Specifications: VOLTS DC: Ranges (5) 200 mV-1000 V. Accuracy:  $\pm(0.5\% \text{ rdg} + 1 \text{ digit})$ . VOLTS AC: Accuracy:  $\pm(1.25\% \text{ rdg} + 5 \text{ digits})$ . AMPS DC: Ranges: (5) 200 $\mu$ A to 20A. Accuracy:  $\pm(0.75\% \text{ rdg} + 1 \text{ digit})$ . AMPS AC: Accuracy: (40 Hz to 500 Hz)  $\pm(1.25\% \text{ rdg} + 5 \text{ digits})$ . RESISTANCE/CONTINUITY: Ranges (6) 200 $\Omega$ -20 M $\Omega$ . Accuracy:  $\pm(0.75\% \text{ rdg} + 1 \text{ digit})$ . DIODE CHECK: Ranges: (3) 0-200 mVDC, 0-2.0 VDC, 0-3.0 VDC. Accuracy:  $\pm(1.5\% \text{ rdg} + 5 \text{ digits})$ . GENERAL: Power: 9 volt battery included. Battery Life: 500 hours.



### Power supply monitors current and voltage

A quality power supply for top performance at 0-30 VDC and full 3 amp output.

Unit features clean output, overload protection constant voltage and current modes, plus current and voltage meters. **SP-2762**

Specifications: Output: Volts: 0-30 DC Amps: 0-3A. Ripple: <5 mV peak-to-peak. Line Regulation: 0.025% + 2 mV. Load Regulation: 0.25% + 5 mV. Power: 120 VAC, 60 Hz. Dimensions: 6.5" H x 9" W x 11" D

### Ungar soldering irons

Ungar irons are some of the very best you'll find, yet they are surprisingly economical. The 25-watt unit is ideal for electronics, hobbies and delicate repairs. Features replaceable tip design and comfortably molded heat-resistant handle. UL listed. Iron holder included. **GDP-3125**



### Tool kit with case

This handy tool kit includes a Weller 20-watt soldering iron with 2 interchangeable tips, a soldering aid, a 4-ounce spool of solder, wire strippers, diagonal cutters, 4" needle nose pliers, 1/4" nut driver, and both slotted and Phillips screwdrivers, and carrying case. **GHP-1270**



### 10-piece tool set

An incredible value, this 10-piece tool kit includes a 30-watt UL listed soldering iron, solder, stand, soldering helper and clip-on heat sink. Plus, you'll get needle nose pliers, a diagonal cutter and 3 screwdrivers. **ST-100**



For Pricing, See Center of Catalog

# ADVANCED WEATHER COMPUTER



\* In conformance with the National Weather Service and FAA guidelines for Wx instrumentation at supplementary aviation Wx reporting stations.

## Professional-Quality Weather Computer

The Heath Advanced Weather Computer is great for the casual weather observer, yet it meets the demands of a professional meteorologist. Thousands of these Weather Computers are used in schools, airports, police stations, museums, radio and TV stations around the world. It's the most sophisticated and affordable weather instrument of its kind.

The computer displays wind speed and direction, indoor and outdoor temperatures, wind chill, barometric pressure, time and date. Sensors allow displays for indoor and outdoor humidity, dew point temperature, rainfall and fog potential. Up/down arrows on the barometer, temperature and humidity displays show direction and rate of change. Visual and/or audible signals warn of severe weather. With the keypad, you can recall peak gusts including direction and time of occurrence; value and time of occurrence for high and low temperature, barometric pressure and humidity. By recalling rate of change in the last hour/last 24 hours, you can observe weather trends and determine the severity of a storm or current conditions.

The wind boom assembly uses high-speed infrared switching diodes and a shutter system for unmatched accuracy and reliability. Four stainless steel bearing assemblies allow the computer to sense even the slightest breeze and guarantee long-term accuracy.

The rain gauge sensor measures rain in remote locations for a constantly updated display. And with the RS-232 interface you can record weather statistics for later analysis. Using your own PC software, weather data can then be turned into charts or graphs. You

can even use a modem with your PC to access that weather information from another modem-equipped PC. Measures 5.8" H x 15.5" W x 8.8" D.

### What you get:

- Deluxe Weather Computer
- Indoor/Outdoor Relative Humidity Sensor
- Rain Gauge Sensor
- RS-232 Computer Interface
- Technical Manual
- Software and Boom Assembly

### IDS-5001

### To Purchase Individual Components:

Indoor/Outdoor Relative Humidity Sensor	IDA-5001-01 Kit
Rain Gauge Sensor	IDA-5001-02
RS-232 Computer Interface	IDA-5001-03 Kit
Technical Manual	IDA-5001-04
PC Compatible Software	IDA-5001-05
Boom Cable 100ft.	IDA-1290-02

### Build It Yourself And Save! Kit Advanced Weather Station

Build it yourself with the same features as the assembled weather station. Order Accessories IDA-5001-04, IDA-5001-05, and IDA-1290-02 separately.

### IDS-5001-02



# MOST ACCURATE CLOCK II

Now, You Can Deliver Precision Time To Every Room Of Your Home or Office Building

More than ten years ago, Heath made precision timekeeping affordable and accessible with the Most Accurate Clock. Thousands of these clocks are counted on every minute of every day by police and fire departments, TV and radio stations, airports and railroads, commercial office buildings, and of course those of us who simply insist on having the right time all the time.

Now Heath is proud to introduce the Most Accurate Clock II, with the same rock-solid accuracy as our original clock, but with the added benefit of remote time display. This amazing timepiece receives and displays electronic time from National Institute of Standards and Technology (NIST) broadcasts. Plus, the Most Accurate Clock II shares that ultra-precise time with one or more remote clocks plugged in anywhere in your home or business.

While it continually monitors NIST short-wave broadcasts from Fort Collins, Colorado, this high-tech instrument displays the hour, minute, second and tenth-of-a-second in local or Universal Coordinated Time. It even gives UTC-1 time, used by astronomers and navigators, and is so accurate that it's time-corrected for the wobble in the earth's rotation. When the 10 MHz receiver is locked onto the NIST signal, the clock displays the time with an unbelievable accuracy of  $\pm 10$  milliseconds. Front panel indicators show the status of time data signal reception. The Most Accurate Clock II improves on the classic with timebase trim indicators, which

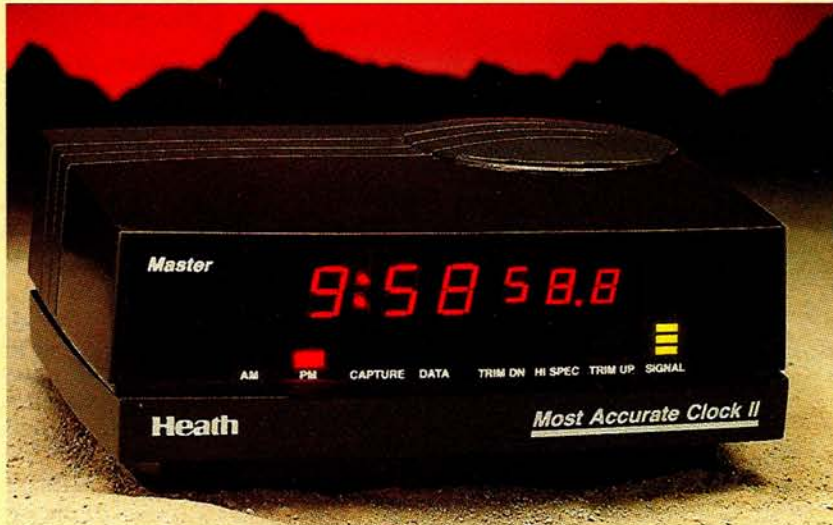

display timebase error correction, and a signal strength indicator to gauge reception of NIST signals. Time is shown in 3/4" and 9/16" LED digits. Rear panel speaker and volume control allow you to listen to NIST time broadcasts. Requires Powerline Interface Accessory for use with remote clocks, or the RS-232 Interface Accessory gives you the clock's time and status on your computer. Operates on 120 VAC with included power supply or 11-14 volts DC. A 10 MHz dipole antenna is recommended but may not be required in your area.

**Most Accurate Clock II** GCW-1001

**Remote Clock.** Features alarm, capture, signal and hi-spec indicators to show status of main clock; receives NIST time from Most Accurate Clock II. GCW-1001-01

**Most Accurate Clock II** with Powerline Interface GCS-1001-A

**Most Accurate Clock II** with RS-232 Accessory and Software GCS-1001-B

**10 MHz Dipole Antenna** GCA-1001-03

## PRACTICAL KITS LET YOU APPLY YOUR KNOWLEDGE



### Digital Clock Adjusts Brightness Automatically

Step-by-step instructions guide you from start to finish to build a feature-packed clock that displays the date and time and adjusts its brightness automatically according to surrounding light. Built-in battery backup keeps the clock running even in a power failure. Snooze alarm sounds at nine-minute intervals. Handsome cabinet measures 2.8" H x 7.1" W x 4.4" D. Battery not included.

**Kit GC-1108**



### Portable Radio

This portable AM radio couldn't be more practical to own. It gets great reception with its high-gain antenna, and a 2" dynamic speaker ensures crisp, clear sound. Uses one 9-volt battery (not included).

**Kit GR-1009**

For Pricing, See Center of Catalog

57

Schools and Commercial Accounts, please call your Heathkit Distributor. See page 58. Individual Students call Heathkit at 1-800-253-0570

# DISTRIBUTORS

Distributor listing for schools and industrial inquiries.

Individual customers, please call Heathkit® directly at 1-800-253-0570.

ALABAMA .....	TECHNICAL TRAINING AIDS, P.O. BOX 20464, BIRMINGHAM, AL 35216 .....	205-988-9231
ALASKA .....	HEATHKIT EDUCATIONAL SYSTEMS, P.O. BOX 1288, BENTON HARBOR, MI 49023 .....	800-253-0570
ARIZONA .....	WEST TECH TRAINING, P.O. BOX 2047, SCOTTSDALE, AZ 85252 .....	800-342-9991
ARKANSAS .....	TECHNICAL TRAINING AIDS, P.O. BOX 20464, BIRMINGHAM, AL 35216 .....	501-224-6354 205-988-9231
CALIFORNIA-NORTH .....	GEORGE L. OLIVER CO., P.O. BOX 1842, FREMONT, CA 94538 .....	800-877-6720
CALIFORNIA-SOUTH .....	RANESCO, 4790 IRVINE BLVD., 4790 RIVINE BLVD., STE 105291, IRVINE, CA 92720 .....	800-824-9939
COLORADO .....	WEST TECH TRAINING, P.O. BOX 2047, SCOTTSDALE, AZ 85252 .....	800-342-9991
CONNECTICUT .....	TECHNICAL EDUCATION PRODUCTS, 87 SOUTH RD., HAMPDEN, MA 01036 .....	800-331-8324
DELAWARE .....	RONALD A. WILLIAMS LTD., P.O. BOX K-34, RICHMOND, VA 23288 .....	800-752-6968
WASHINGTON DC .....	RONALD A. WILLIAMS LTD., P.O. BOX K-34, RICHMOND, VA 23288 .....	800-752-6968
FLORIDA-NORTH .....	TECHNICAL TRAINING AIDS, 502 SOUTH PHELPS, WINTER PARK, FL 32789 .....	407-647-5373
FLORIDA-SOUTH .....	TECHNICAL TRAINING AIDS, 2630 ALOE AVE., COCONUT CREEK, FL 33063 .....	305-979-1669
GEORGIA .....	TECHNICAL TRAINING AIDS, 3615 PARKMONT CT., NORCROSS, GA 30092 .....	404-447-5231 205-988-9231
HAWAII .....	HEATHKIT EDUCATIONAL SYSTEMS, P.O. BOX 1288, BENTON HARBOR, MI 49023 .....	800-253-0570
IDAHO .....	WEST TECH TRAINING, P.O. BOX 2047, SCOTTSDALE, AZ 85252 .....	800-342-9991
ILLINOIS-NORTH .....	JBH TECHNICAL SALES, 9243 BELLEFORT, MORTON GROVE, IL 60053 .....	708-966-9310
ILLINOIS-SOUTH .....	NONAME, INC., 2701 GRAND AVE., GALESBURG, IL 61401 .....	800-373-6135
INDIANA .....	HOWARD AND SMITH, INC., P.O. BOX 457, ROYAL OAK, MI 48068 .....	800-437-0085
IOWA .....	LEARNING CONCEPTS, 12315 W. 100TH PLACE, LENEXA, KS 66215 .....	800-289-6463
KANSAS .....	LEARNING CONCEPTS, 12315 W. 100TH PLACE, LENEXA, KS 66215 .....	800-289-6463
KENTUCKY .....	TECHNICAL TRAINING AIDS, P.O. BOX 17537, COVINGTON, KY 41017 .....	606-331-6665
LOUISIANA .....	TECHNICAL TRAINING AIDS, P.O. BOX 20464, BIRMINGHAM, AL 35216 .....	601-856-0006 205-988-9231
MAINE .....	TECHNICAL EDUCATION PRODUCTS, 87 SOUTH ROAD, HAMPDEN, MA 01036 .....	800-331-8324
MARYLAND .....	RONALD A. WILLIAMS LTD., P.O. BOX K-34, RICHMOND, VA 23288 .....	800-752-6968
MASSACHUSETTS .....	TECHNICAL EDUCATION PRODUCTS, 87 SOUTH ROAD, HAMPDEN, MA 01036 .....	800-331-8324
MICHIGAN .....	HOWARD AND SMITH, INC., P.O. BOX 457, ROYAL OAK, MI 48068 .....	800-548-9948
MINNESOTA .....	HEATHKIT EDUCATIONAL SYSTEMS, P.O. BOX 1288, BENTON HARBOR, MI 49023 .....	800-253-0570
MISSISSIPPI .....	TECHNICAL TRAINING AIDS, P.O. BOX 232, RIDGELAND, MS 39158 .....	601-856-0006 205-988-9231
MISSOURI .....	LEARNING CONCEPTS, 12315 W. 100TH PLACE, LENEXA, KS 66215 .....	800-289-6463
MONTANA .....	HEATHKIT EDUCATIONAL SYSTEMS, P.O. BOX 1288, BENTON HARBOR, MI 49023 .....	800-253-0570
NEBRASKA .....	LEARNING CONCEPTS, 12315 W. 100TH PLACE, LENEXA, KS 66215 .....	800-289-6463
NEVADA .....	GEORGE L. OLIVER CO., P.O. BOX 1842, FREMONT, CA 94538 .....	800-877-6720
NEW HAMPSHIRE .....	TECHNICAL EDUCATION PRODUCTS, 87 SOUTH ROAD, HAMPDEN, MA 01036 .....	800-331-8324
NEW JERSEY .....	DRYDEN EDUCATIONAL SALES, 525 PROSPECT AVE., NEPTUNE, NJ 07753 .....	800-354-2606
NEW MEXICO .....	WEST TECH TRAINING, P.O. BOX 2047, SCOTTSDALE, AZ 85252 .....	800-342-9991
NEW YORK .....	TECHNICAL EDUCATION PRODUCTS, 87 SOUTH ROAD, HAMPDEN, MA 01036 .....	800-331-8324
NORTH CAROLINA .....	CAROLINA TRAINING ASSOC., P.O. BOX 816, SANFORD, NC 27330 .....	800-962-8815
NORTH DAKOTA .....	HEATHKIT EDUCATIONAL SYSTEMS, P.O. BOX 1288, BENTON HARBOR, MI 49023 .....	800-253-0570
OHIO .....	SIMC TRAINING SYSTEMS, 709 CONANT ST., MAUMEE, OH 43537 .....	800-421-7462 419-891-9969
OKLAHOMA .....	TEACHING SYSTEMS, 9050 AUTOBAHN DR., STE 100, DALLAS, TX 75237 .....	800-762-4133
OREGON .....	HEATHKIT EDUCATIONAL SYSTEMS, P.O. BOX 1288, BENTON HARBOR, MI 49023 .....	800-253-0570
PENNSYLVANIA-EAST .....	DRYDEN EDUCATIONAL SALES, 525 PROSPECT AVE., NEPTUNE, NJ 07753 .....	800-354-2606
PENNSYLVANIA-WEST .....	SIMC TRAINING SYSTEMS, 709 CONANT ST., MAUMEE, OH 43537 .....	800-421-7462 419-891-9969
RHODE ISLAND .....	TECHNICAL EDUCATION PRODUCTS, 87 SOUTH ROAD, HAMPDEN, MA 01036 .....	800-331-8324
SOUTH CAROLINA .....	CAROLINA TRAINING ASSOC., P.O. BOX 816, SANFORD, NC 27330 .....	800-962-8815
SOUTH DAKOTA .....	HEATHKIT EDUCATIONAL SYSTEMS, P.O. BOX 1288, BENTON HARBOR, MI 49023 .....	800-253-0570
TENNESSEE .....	TECHNICAL TRAINING AIDS, P.O. BOX 17537, COVINGTON, KY 41017 .....	606-331-6665 205-988-9231
TEXAS .....	TEACHING SYSTEMS, 9050 AUTOBAHN DR., STE. 100, DALLAS, TX 75237 .....	800-762-4133
UTAH .....	WEST TECH TRAINING, P.O. BOX 2047, SCOTTSDALE, AZ 85252 .....	800-342-9991
VERMONT .....	TECHNICAL EDUCATION PRODUCTS, 87 SOUTH ROAD, HAMPDEN, MA 01036 .....	800-331-8324
VIRGINIA .....	RONALD A. WILLIAMS LTD., P.O. BOX K-34, RICHMOND, VA 23288 .....	800-752-6968
WASHINGTON .....	HEATHKIT EDUCATIONAL SYSTEMS, P.O. BOX 1288, BENTON HARBOR, MI 49023 .....	800-253-0570
WEST VIRGINIA .....	RONALD A. WILLIAMS LTD., P.O. BOX K-34, RICHMOND, VA 23288 .....	800-752-6968
WISCONSIN .....	HEATHKIT EDUCATIONAL SYSTEMS, P.O. BOX 1288, BENTON HARBOR, MI 49023 .....	800-253-0570
WYOMING .....	WEST TECH TRAINING, P.O. BOX 2047, SCOTTSDALE, AZ 85252 .....	800-342-9991
CANADA .....	ELECTROLAB, LTD., P.O. BOX 320 BELLEVILLE, ONTARIO, CANADA K8N 5A5 .....	800-267-7482

# DOING BUSINESS HONORABLY

## 30-DAY NO-RISK GUARANTEE

Simply put, you can't lose with Heathkit. If you're not absolutely satisfied, just return the product and we'll refund your money.

Order by Phone 24 Hours a Day  
1-800-253-0570

The fastest and easiest way to place an order, all day, every day. Most phone orders are processed within 24 hours. (Items ordered together may not always be shipped together). To check on an order already placed, please call Monday - Friday 8:00 a.m. to 4:30 p.m. EST.

Order by Fax 24 Hours a Day  
1-616-925-4876

Just fax a copy of your completed order form, anytime, day or night.

Order by Mail  
P.O. Box 1288,  
Benton Harbor, MI 49023

Please give full address, including apartment number, if any. Please print legibly to avoid error. Include quantity, model number, description, weight and price for each item.

### Customer Service

For answers to questions about returns and exchanges, call 1-800-253-0570 Monday - Friday 8:00 a.m. to 4:30 p.m. EST.

### Minimum Order

Our minimum order for product and/or replacement parts is \$15.

© 1994 Heath Company. Heath and Heathkit are registered trademarks of Heath Company. Heath Company reserves the right to alter product availability, price and/or specifications without notice. Windows, MS/DOS, Windows and for Workgroups are registered trademarks of Microsoft Corporation. NetWare and NetWare-Lite are registered trademarks of Novell Corp. All other brand product and company names appearing in this catalog are registered trademarks of their respective holders.

### Return Policy

You may exchange or return any product within 30 days of purchase. Please use the Product Return Form that will be enclosed with your order.

### Technical Consultants

Our technical consultants are ready to answer your questions about products before or after any purchase from a Heathkit Educational Systems catalog. Please call 616-925-4914 Monday - Friday 8:00 a.m. to 4:30 p.m. EST. For help with Heath/Zenith Security and Lighting products, call 616-925-5181.

### Parts Replacement and Product Repair Service

To order parts, call 1-616-925-5899 Monday - Friday 8:00 a.m. to 4:30 p.m. EST. Please have the part number ready. For product service, call 616-925-3273, Monday - Friday 8:00 a.m. to 4:30 p.m.

### Catalog Subscription

To order a FREE Heathkit Educational Systems Catalog, call 1-800-44-HEATH 24 hours a day, 7 days a week. When you place an order your name is automatically added to our mailing list.

## ONE-YEAR LIMITED WARRANTY ON ALL HARDWARE AND EQUIPMENT

### Shipping Charges/ Cont. U.S. St. Addresses

Ship Wt (lbs.)	Shipping Charges
1-2	\$5.75
3-4	\$6.50
5-9	\$7.00
10-14	\$8.50
15-19	\$10.25
20-29	\$12.00
30-39	\$16.00
40-49	\$20.00
50-69	\$26.00
70-99	\$39.00
100+	\$55.00

## Shipping Information

1. Total the ship weights of all items ordered.
2. Determine the shipping charges for your total order.

Standard Delivery	Shipping Charges	Delivery*
To Continental U.S. (Street Addresses)	(see chart above)	7-10 days
Continental U.S. (P.O. Boxes)	\$1.00 per pound+ \$2.00	7-10 days
APO/FPO	\$1.00 per pound+ \$3.00	10-20 days
Alaska, Hawaii, Puerto Rico	\$1.00 per pound+ \$5.00	10-20 days
Express Delivery	Shipping Charges	Delivery*
To Continental U.S. (Street Addresses)	\$1.25 per pound+ \$8.00	2-3 days
Continental U.S. (P.O. Boxes)	not available	not available
APO/FPO	not available	not available
Alaska, Hawaii, Puerto Rico	\$1.25 per pound+ \$11.00	4-5 days

\*estimated delivery for products in stock

# Heathkit Educational Systems

P.O. Box 1288  
Benton Harbor, MI 49023

Name \_\_\_\_\_

Address \_\_\_\_\_

\_\_\_\_\_ Apt. \_\_\_\_\_

City \_\_\_\_\_

State \_\_\_\_\_ ZIP \_\_\_\_\_

Daytime phone (\_\_\_\_) \_\_\_\_\_

(in case we need to contact you concerning your order).

Ship to (if different than bill to):

Name \_\_\_\_\_

Address \_\_\_\_\_

\_\_\_\_\_ Apt. \_\_\_\_\_

City \_\_\_\_\_

State \_\_\_\_\_ ZIP \_\_\_\_\_

If address is incorrect, please correct here

Name \_\_\_\_\_

Address \_\_\_\_\_

\_\_\_\_\_ Apt. \_\_\_\_\_

City \_\_\_\_\_

State \_\_\_\_\_ ZIP \_\_\_\_\_

QUAN.	MODEL NUMBER	DESCRIPTION	PRICE PER ITEM	TOTAL PRICE	SHIP WEIGHT



Order Toll-Free 24 hours a day

**1-800-253-0570**

FAX Your credit card order  
616-925-4876

For Express Delivery please check   
See Shipping Chart for express charges

<b>SUBTOTAL</b>		Total Ship Weight _____ lbs.
Less allowance if any		
Merchandise	<b>TOTAL</b>	
Sales tax	MO 4.225%	
CA 8.25% KS 4.9% PA 6.0%		
CT 6.0% MI 4.0% TX 6.25%		
IN 5.0% NC 6.0% VA 4.5% +		
Shipping Charges (See Shipping Chart)	+	
<b>TOTAL AMOUNT OF ORDER</b>		

## Payment Options

Charge. Most approved credit card orders are processed within 24 hours and your account will not be charged until product is shipped.



Account No. \_\_\_\_\_

Exp. date \_\_\_\_\_

Signature \_\_\_\_\_

(necessary for all charges)

Check or money order (U.S. dollars only). Personal checks must have name and address preprinted; please include daytime phone number.

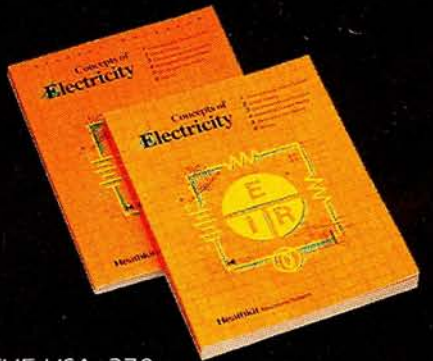
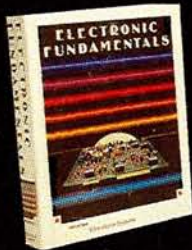
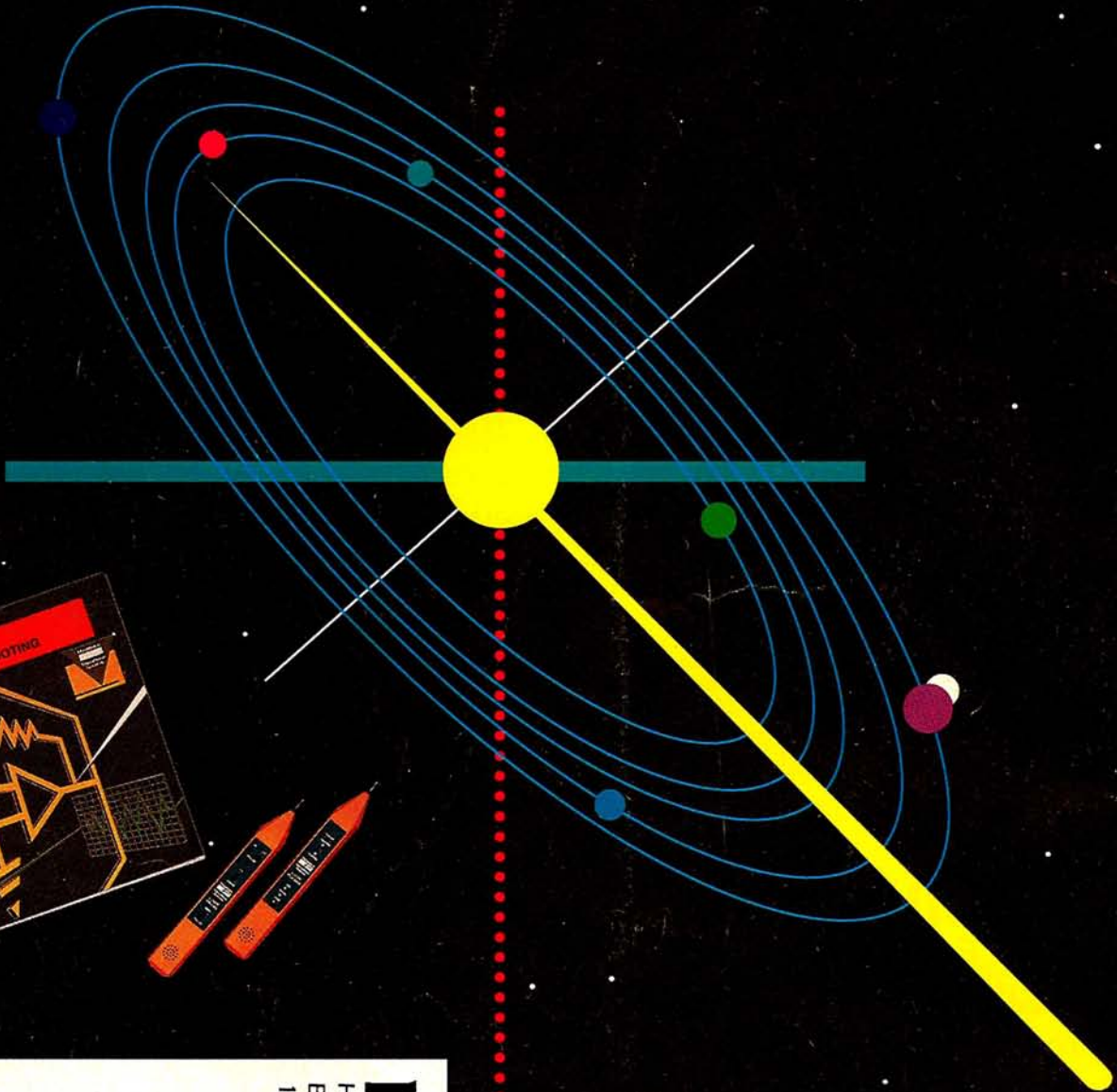

**Heathkit**  
HEATH COMPANY  
BENTON HARBOR, MI 49022  
1-800-253-0570

CURRENT RESIDENT  
OR

**BULK RATE**  
U.S. Postage  
Paid  
Heath Company

WHEN ORDERING BY PHONE,  
PLEASE USE THIS CODE

270-001